

# CONFERENCE PROCEEDINGS

15th Annual International Bata Conference  
for Ph.D. Students and Young Researchers

DRIVE  
YOUR  
KNOWLEDGE  
BE  
A  
SCIENTIST  
6-7/11/2019

 Tomas Bata University in Zlín  
Faculty of Management and Economics

**Conference Proceedings**  
**DOKBAT**  
**15th Annual International Bata Conference**  
**for Ph.D. Students and Young Researchers**



**Tomas Bata University in Zlín**  
**Faculty of Management and Economics**  
**Mostní 5139 – Zlín, 760 01**  
**Czech Republic**

Copyright © 2021 by authors. All rights reserved. Digital publishing – [www.dokbat.utb.cz](http://www.dokbat.utb.cz).  
Published in 2021.

Edited by: Ing. Pavel Ondra

ISBN: 978-80-7454-980-9

DOI: 10.7441/dokbat.2019

The publication was released within the DOKBAT conference, supported by the IGA project No. SVK/FaME/2019/001.

Many thanks to the reviewers who helped ensure the quality of the papers.

No reproduction, copies or transmissions may be made without written permission from the individual authors.

## HOW TO CITE

Surname, First Name. (2021). Title. In *DOKBAT 2019 - 15th Annual International Bata Conference for Ph.D. Students and Young Researchers* (Vol. 15), Second edition. Zlín: Tomas Bata University in Zlín, Faculty of Management and Economics. Retrieved from <http://dokbat.utb.cz/conference-proceedings/> ISBN: 978-80-7454-980-9



## CONTENT

ADVERTISING ON FOOD CHOICE: A STUDY OF BANK WORKERS IN GHANA .....	12
Daniel Edem Adzovie, Eunice Eshun, Philip Arthur Gborsong .....	12
LEADER'S ENVY AND KNOWLEDGE HIDING IN UNIVERSITIES IN PAKISTAN....	22
Moazzam Ali, Muhammad Usman, Nhat Tan Pham .....	22
USING KANO METHOD TO MEASURE EMPLOYEE SATISFACTION.....	35
Shavkat Alimov .....	35
SUPPLIER-RELATIONSHIP MANAGEMENT, COMPETITIVE ADVANTAGE AND FIRM PERFORMANCE IN THE SERVICE INDUSTRY: A CONCEPTUAL STUDY .....	40
Christina Appiah-Nimo, Daniel Ofori, Michael Adu Kwarteng, Miloslava Chovancová... 40	
THE INTEGRATED REPORTING “STAKEHOLDER RELATIONSHIPS” PRINCIPLE IN THE EUROPEAN FINANCIAL SECTOR .....	50
Bianca Raluca Bădițoiu .....	50
CONTRACTUAL ARRANGEMENTS AND UNFAIR TRADING PRACTICES: EVIDENCE FROM DAIRY FARM SECTOR IN SLOVAKIA.....	61
Katarína Baráthová, Lucia Vargová, Martin Jamrich .....	61
MARKET-BASED PERFORMANCE MEASURES: A SHAREHOLDER'S PERSPECTIVE .....	76
Abu Bawa.....	76
LOW-COST REAL-TIME MEASURING AND ANALYSIS SYSTEM FOR INDUSTRIAL ENVIRONMENTS .....	84
Primož Bencak, Dušan Fister, Tone Lerher .....	84
MICROFINANCE AND THE MILLENNIUM DEVELOPMENT GOALS .....	94
Marta Paula Bendelová, Artan Qineti, Martina Zaujecová .....	94
THE EFFECT OF MFI PERFORMANCE INDICATORS ON POVERTY .....	107
Marta Paula Bendelová, Artan Qineti, Martina Zaujecová.....	107
DEFINING FINANCIAL RISK: A REVIEW OF APPROACHES.....	119
Lucie Brabcová .....	119
ECO LABELS, CRADLE TO CRADLE CERTIFICATE AND THEIR CONNECTION TO THE SUPPLY CHAIN.....	129
Kristijan Brglez, Žiga Korent, Matevž Obrecht .....	129
PACKAGE-FREE FOOD SALES AS A NEW TREND IN SLOVAK REPUBLIC COMPANIES.....	138
Rebecca Brodňanová, Marek Plachý .....	138
CONVERGENCE OF EMPLOYMENT AND UNEMPLOYMENT RATES OF TERTIARY EDUCATED IN NUTS 3 REGIONS OF THE CZECH AND SLOVAK REPUBLIC .....	147
Patrik Bulko, Katarína Škrovánková, Júlia Kostrová .....	147
LONG-TERM IMPACT OF BREXIT ON AUSTRIAN ECONOMY – SINGLE COUNTRY CGE MODEL.....	155
Lukáš Burian .....	155
ELECTRIC CARS FOR SMARTER CITIES: REGRESSION MODEL .....	161
Arunas Burinskas .....	161

REVIEW OF METHODS FOR CIRCULAR SUPPLY CHAIN ANALYSIS: THE APPLICATION FOR OPTIMISATION STUDIES .....	169
Aurelija Burinskiene .....	169
DETERMINANTS OF FINANCIAL CAPABILITY: EVIDENCE FROM A TRANSITION COUNTRY.....	181
Gentjan Çera, Bekim Poleshi, Khurram Ajaz Khan, Arjan Shumeli, Oksana Kojku .....	181
PRODUCTION OF CO2 EMISSIONS FROM MARITIME CONTAINER SHIPPING IN COMPARISON WITH ROAD CONTAINER TRANSPORT .....	195
Iris Čeh .....	195
WHICH FACTORS INFLUENCE CONSUMER ETHNOCENTRISM? THE CASE OF SLOVAKIA .....	208
Marián Čvirik .....	208
STRUCTURAL EVALUATION OF ATTITUDES TOWARDS RURAL TOURISM: A PROPOSED STUDY .....	217
Sandeep Kumar Dey, Zuzana Tučková.....	217
INFLUENCE OF CONSTRUCTION OF LOGISTICS CENTRE ON TRANSPORT IN VIENNA.....	229
Radek Dvořáček, Kateřina Víchová.....	229
POSSIBILITIES OF USING GEOGRAPHIC INFORMATION SYSTEMS IN TRANSPORT .....	237
Martin Džermanský.....	237
EVALUATION OF DEVELOPMENT OF SUPPLY OF THE SELECTED RESIDENTAL SOCIAL SERVICES FOR ELDERLY.....	246
Izabela Ertingerová .....	246
THE FACTORS INFLUENCING SENSORY MARKETING IN NON-FOOD RETAIL... 257	
Michael Fafílek .....	257
ANALYSIS OF SELECTED FACTORS INFLUENCING THE SAFETY OF OVERSIZE TRANSPORT.....	266
Teresa Gajewska, Anna Grabarz .....	266
CHARACTERIZATION OF PEDESTRIAN AND MIXED STREETS AND ITS INFLUENCE IN FREIGHT ACTIVITIES.....	274
Juan Carlos Gómez, María Victoria de la Fuente, Lorenzo Ros.....	274
POTENTIAL OF IMPLEMENTING SMART GLASSES IN A BRICK AND MORTAR SHOP ENVIRONMENT .....	287
Tadej Gračner, Luka Herman, Brigita Gajšek.....	287
SUPPORT OF INNOVATIONS IN MAIN DEVELOPMENT STRATEGIES OF REGIONAL CAPITALS IN THE CZECH REPUBLIC .....	297
Martin Habuda, Ladislav Kudláček, Aleš Gregar .....	297
LEGAL BASES FOR THE GDPR IMPLEMENTATION IN MARKETING .....	309
Lenka Hanáková.....	309
ASSESSING THE DISSIMILARITIES OF GAME MECHANICS ON ALBANIAN WORKING-CLASS CONSUMERS .....	322
Fortesa Haziri, Fortune Nwaiwu, Miloslava Chovancová .....	322
IMPORTANCE OF INTERNAL CONTROLLING IN FRAUD DETECTION IN CZECH ENTITIES .....	332

Jana Helová .....	332
REFORM OF PENSION SYSTEM AS A WAY FOR SOCIAL STABILITY .....	342
Raman Herasimau .....	342
THE THEORY OF PLANNED BEHAVIOR TOWARD ORGANIC FOOD IN VIETNAM: THE MODERATION OF ENVIRONMENTAL CONCERN .....	350
Hung Cuong Hoang, Miloslava Chovancová, Hoang Thi Que Huong, Abdul Bashiru Jibril .....	350
ASSESSING THE IMPACT OF GLOBAL DIGITAL ENVIRONMENT ON THE ONLINE REPUTATION OF SELECTED CAR BRANDS IN SLOVAK AND GLOBAL MARKET .....	363
Vladimír Hojdík .....	363
A START-UP – WHAT REALLY MATTERS AT FIRST .....	374
Jana Hubinová Skubeňová .....	374
EXPLORING THE ROLE OF DESTINATION IMAGE TO ECOTOURISM INTENTION .....	385
Vo Viet Hung, Zuzana Tuckova, Hung Cuong Hoang .....	385
INTRODUCTORY ANALYSIS OF POSSIBILITY TO UTILIZE POTENTIAL OF LEAN AND AGILE MANUFACTURING METHODS IN CONDITIONS OF INDUSTRY 4.0..	399
Mikuláš Hurta, Darja Noskievičová.....	399
THE EFFECT OF SOCIAL MEDIA MARKETING ACTIVITIES ON CUSTOMER BEHAVIOUR .....	410
Romina Cheraghalizadeh .....	410
BRAND MANAGEMENT ANALYSIS: AN EMPIRICAL STUDY IN HIGHER-QUALITY CZECH RAILWAY TRAINS .....	421
Jan Chocholáč, Nina Kudláčková .....	421
RISK ANALYSIS IN THE LOGISTICS COMPANY FOR DISTRIBUTION OF PHARMACEUTICALS .....	430
Lucie Chromcová .....	430
CUSTOMER LOYALTY IN SMALL AND MEDIUM-SIZED CZECH ENTERPRISES .	436
Adéla Chromčáková.....	436
THE IMPACT OF REMUNERATION ON CEO MOTIVATION: EMPIRICAL EVIDENCE FROM THE CZECH REPUBLIC .....	445
Kateřina Jančíková .....	445
ADAPTIVE NEURO-FUZZY INFERENCE SYSTEM (ANFIS) FOR FORECASTING: THE CASE OF THE CZECH STOCK MARKET .....	457
Zuzana Janková .....	457
SUSTAINABLE TOURISM: ANTECEDENT DIMENSIONS AND FUTURE AGENDA	466
Mohsin Javed, Zuzana Tučková.....	466
‘SHOULD I PURCHASE OR NOT’? A LITERATURE REVIEW OF COUNTRY-OF- ORIGIN EFFECT ON THE USE OF DOMESTIC BRAND.....	478
Abdul Bashiru Jibril, Michael Adu Kwarteng, Miloslava Chovancová, Richard Denanyoh, Victor Kwarteng Owusu, Hoang Hung Cuong .....	478
CONSULTING AN IMPORTANT SUPPORT FOR PEOPLE WITH DISABILITIES AS ENTREPRENEURS.....	489
Bernard Joseph-Auguste .....	489

OPENING PANDORA'S BOX: NEUROMARKETING AND BRAND IMAGE .....	500
Dinko Jukić .....	500
THE INTERNATIONAL TRANSMISSION OF THE EUROPEAN CENTRAL BANK MONETARY POLICY: EVIDENCE FROM THE CZECH REPUBLIC .....	513
Lukáš Jursa .....	513
COMPLEXITY AND PREFERENCES IN THE SERVICE FACILITY OFFER IN THE SLOVAK BUSINESS ENVIRONMENT .....	530
Paula Kamodyová, Marek Potkány .....	530
EVALUATION OF BUSINESS CULTURE IN THE SELECTED COMPANY .....	540
Radka Kataniková, Pavol Grman, Petronela Švikruhová .....	540
MEASUREMENT OF CREATIVE INDUSTRY ENTITIES' PERFORMANCE IN SLOVAKIA .....	551
Mária Kmety Barteková, Monika Raková .....	551
THE ROLE OF TRADE MARKETING FUNCTION IN MARKETING-SALES INTERFACE.....	558
Daniela Kolouchová.....	558
COMPARISON EFFICIENT PRICE OF COMPENSATION OF SUBURBAN BUS TRANSPORT IN SELECTED REGIONS .....	566
Natálie Konečná .....	566
LEX ONDAVKA AS INSUFFICIENT SOLUTION OF THE PROBLEM OF DISINTEGRATION PROCESS OF MUNICIPALITIES AFTER 1989 IN SLOVAKIA....	575
Gabriel Kopúnek .....	575
SPECIFICS OF NEUROMARKETING AND ITS APPLICATION ON FRAGILE TARGERT GROUP CHILDREN.....	586
Denisa Kraľovičová .....	586
PUBLIC HOSPITAL PERFORMANCE MANAGEMENT: A QUESTIONNAIRE DESIGN .....	594
Josef Krupička.....	594
REASONS AND PROPOSAL OF APPLICATION OF MANAGEMENT METHODS IN PROCESSES OF QUALITY ASSURANCE AT HIGHER EDUCATION INSTITUTIONS IN The SLOVAK REPUBLIC .....	605
Adriana Krupová .....	605
CORPORATE SOCIAL RESPONSIBILITY (CSR) REFLECTED IN ADVERTISEMENT ACTIVITES .....	621
Martin Kuchta, Monika Stankova, Maria Hasprova .....	621
THE ROLE OF SOCIAL MEDIA USAGE IN THE EFFECTIVENESS OF MANAGERS FROM FOOD COMPANIES.....	635
Silvia Lenčesová, Mária Šajbidorová, Zuzana Lušňáková, Boris Rumanko .....	635
MEASUREMENT OF ECONOMIC VALUE OF BEE POLLINATION THROUGH BIOECONOMIC APPROACH IN CONDITIONS OF SLOVAK AND CZECH REPUBLIC .....	644
Michal Levický .....	644
BEYOND THE SCALES: CONCEPTUAL DISCUSSION OF STRUCTURAL EMPOWERMENT BASED ON IN-DEPTH INTERVIEWS.....	654
Ivana Lukeš Rybanská, Šárka Nováková .....	654

ANALYSIS OF THE INTERACTIONS OF SOCIAL NETWORK USERS IN CENTRAL SLOVAKIA BASED ON THE TIMING OF COMMUNICATION .....	668
Barbora Marišová, František Olšovský, Eva Smolková, Lukáš Vaľko.....	668
DISCRETE EVENT SIMULATION OF N-DEEP SHUTTLE BASED STORAGE SYSTEM .....	678
Jakob Marolt, Tone Lerher.....	678
COMPANY PERFORMANCE BASED ON HUMAN RESOURCE PRACTICES: CASE STUDY IN THE SOUTHWEST REGION OF ROMANIA .....	686
Mădălina Dumitrița Maticiuc .....	686
INNOVATIONS IN THE DISTRIBUTION OF INTELLECTUAL PROPERTY IN THE DIGITAL ERA.....	694
Martin Matušovič .....	694
GENERATIONAL APPROACHES AND PREFERENCES TOWARDS KNOWLEDGE SHARING: IMPLICATIONS FOR HUMAN RESOURCE PRACTICES .....	707
Anastasiia Mazurchenko .....	707
HOUSE PRICES: ANALYZING THE EFFECT OF MACROECONOMIC DETERMINANTS.....	718
Aleš Melecký, Siyu Liu.....	718
THE BENEFITS THAT CREATIVE INDUSTRIES CAN OFFER TO COUNTRIES CAUGHT IN MIDDLE INCOME TRAP .....	727
Peter Mičák .....	727
SUSTAINABLE URBAN MOBILITY PLANNING IN THE MUNICIPALITY OF TARNÓW .....	735
Maciej Michnej, Anna Kuczaj .....	735
E-BUSINESS TECHNOLOGY .....	745
Denisa Mikulová .....	745
POSSIBILITIES OF NON-REPLICABLE MEASUREMENT SYSTEMS ANALYSIS ...	756
Pavĺína Mikulová .....	756
SUCCESSION IN FAMILY BUSINESSES IN SLOVAKIA.....	766
Jarmila Mižičková, Michal Levický.....	766
CONCEPTUAL MODEL TO ANALYZE THE INFLUENCE OF CUSTOMER PARTICIPATION AND VALUE CO-CREATION IN SOCIAL MEDIA ON BRAND PERFORMANCE .....	772
Taha Nejad Falatouri Moghaddam.....	772
APPLYING THE EXPECTED CREDIT LOSS MODEL UNDER IFRS 9 ON ISLAMIC SUKUK: EMPIRICAL EVIDENCE FROM JORDAN PUBLICLY TRADED COMPANIES .....	778
Amer Morshed.....	778
INNOVATIVE APPROACH IN THE DUE DILIGENCE PROCESS.....	786
Christoph Müller .....	786
SUPPLY CHAIN MANAGEMENT TOWARD INDUSTRY 4.0: A LITERATURE REVIEW .....	799
Vy T. T. Nguyen, Tam T. T. Nguyen.....	799
FACTORS INFLUENCING INFLATION IN THE CZECH REPUBLIC .....	809
Sára Novorytová.....	809

DIGITAL TRANSFORMATION OR INFORMATION MANAGEMENT: WHAT DIRECTION ARE COMPANIES GOING IN? .....	820
Fortune Nwaiwu, Ladislav Buřita .....	820
THE CONSEQUENCES OF LEARNING ORIENTATION ON THE COMPANY PERFORMANCE .....	832
Daniel Darius Onetiu.....	832
TRENDS IN FINANCIAL PERFORMANCE ASSESSMENT OF TRAVEL AGENCIES .....	841
Erika Onuferová, Veronika Čabinová, Peter Gallo, Mária Matijová, Nikola Sikorová Jurová .....	841
MENTEE-MENTOR COOPERATION, MENTEE BENEFIT AND ORGANIZATIONAL PERFORMANCE: A LITERATURE REVIEW .....	857
Victor Kwarteng Owusu, Aleš Gregar .....	857
POST-CRISIS EXPANSIONARY FISCAL CONTRACTIONS.....	867
Jakub Pavelek.....	867
THE RISK MANAGEMENT IN THE SELECTED COMPANY .....	873
Radim Pavelek.....	873
PENSION DEBT OF THE FUTURE AND ITS DEPENDS ON RETIREMENT AGE: COMPARISON BETWEEN CZECHIA AND DENMARK .....	879
Jan Pokorný, Pavlína Hejduková .....	879
THE IMPACT OF FISCAL DECENTRALIZATION ON THE ECONOMIC GROWTH IN EUROPEAN COUNTRIES, 2001-2017 .....	890
Tereza Powadová .....	890
SENSORY MARKETING IN THE DIGITAL ERA: ANALYZING THE GLOBAL MARKETING ENVIRONMENT AND CONSUMER CULTURE .....	898
Tomáš Rebič, Elena Horská .....	898
THE CURRENT TREND IN THE INDUSTRY - INDUSTRY 4.0 IN SLOVAK ENTERPRISES .....	904
Patrik Richnák .....	904
CIVIC PARTICIPATION AND MUNICIPAL ELECTIONS IN MUNICIPALITIES OF TRNAVA REGION .....	914
León Richvalský.....	914
CASE STUDY OF DIAGNOSTIC METHODS AND THEIR USE IN EMPLOYEE SELECTION .....	925
Boris Rumanko, Zuzana Lušňáková, Mária Šajbidorová, Silvia Lenčేశová.....	925
METHODOLOGY FOR APPLICATION OF NON-PARAMETRIC METHODS OF STATISTICAL PROCESS CONTROL INTO PRACTICE .....	934
Tereza Smajdorová, Darja Noskievičová.....	934
RE-LAYOUT OF WORKSHOP BASED ON MATERIAL AND PEOPLE FLOWS .....	943
Vladimír Sojka, Petr Lepšík .....	943
FAMILY BUSINESS OWNERS PLAN OVER THE LONG TERM: FRAMEWORK OF RESEARCH AND PRELIMINARY RESULTS COVERING THE CZECH REPUBLIC..	950
Pavla Srbová.....	950
A STRUCTURED REVIEW OF THE SIX SIGMA BELT SYSTEM .....	958
Roland Stankalla, Felicita Chromjaková.....	958

POTENTIALS OF KPI SYNCHRONIZATION IN THE SUPPLY CHAIN .....	971
Diána Strommer .....	971
SHARING CITIES: INFLUENCE OF TIME BANKS ON URBAN DEVELOPMENT.....	982
Dominika Šafrová, Pavlína Hejduková .....	982
POSSIBILITIES OF DETECTING FRAUD IN FINANCIAL STATEMENTS WITH FOCUS ON ANALYTICAL METHODS OF EVALUATING FINANCIAL STATEMENTS .....	992
Jaroslava Šepeľová.....	992
AGRICULTURE AND ITS POSITION WITHIN THE COUNTRY'S ECONOMY .....	1001
Elena Širá .....	1001
ENVIRONMENTAL & INDUSTRIAL EFFECTS OF PALM OIL.....	1008
Izidor Škrbot, Mark Kmetec, Timitej Zorman, Domen Keblič, Matevž Obrecht.....	1008
CHANGES IN THE REPRODUCTION BEHAVIOUR OF THE POPULATION AND THEIR IMPACT ON THE LABOUR MARKET IN THE SLOVAK REPUBLIC.....	1021
Katarína Škrovánková, Júlia Kostrová, Patrik Bulko .....	1021
THE IMPACT OF SUBSIDIES ON THE REGIONAL PASSENGER RAIL TRANSPORT .....	1033
Ondřej Špetík.....	1033
EMPLOYER BRANDING AS THE COMPETITIVE TOOL OF MANAGERS .....	1040
Dana Šrámková .....	1040
DETERMINATION OF REAL ESTATE MARKET PRICES USING ARTIFICIAL NEURAL NETWORKS .....	1050
Michaela Štubňová, Marta Urbaníková .....	1050
THE NEW INSIGHT INTO COMPLEX CUSTOMER LOYALTY MEASUREMENT ..	1059
Eva Tylečková, Jaroslav Nenadál .....	1059
TRAFFIC MICROSCOPIC SIMULATION IN THE TOWN KYJOV .....	1070
Gabriela Tylová, Kateřina Víchová .....	1070
HOW DOES BOARD DIVERSITY IMPACT PROFITABILITY THROUGH FINANCING DECISIONS? EVIDENCE FROM OIL AND GAS INDUSTRY .....	1079
Sorana Vatavu .....	1079
THE INFLUENCE OF INTERNET MARKETING ON CONSUMER BUYING BEHAVIOUR (GEORGIA'S EXAMPLE) .....	1088
Giorgi Zarnadze.....	1088
DETERMINATION OF OPTIMAL CROP PRODUCTION IN MAIZE REGION OF SLOVAK REPUBLIC, UNDER CONDITIONS OF UNCERTAINTY.....	1094
Martina Zaujecová, Jozef Repiský .....	1094
SMART CITY AND REGION IN THE CZECH REPUBLIC WITH A FOCUS ON THE ZLÍN REGION.....	1106
Lukáš Zlámal.....	1106
LOGISTICS MODEL FOR E-COMMERCE IN AN ONLINE COMPANY .....	1117
Artur Zygiert .....	1117

# ADVERTISING ON FOOD CHOICE: A STUDY OF BANK WORKERS IN GHANA

*Daniel Edem Adzovie, Eunice Eshun, Philip Arthur Gborsong*

## **Abstract**

The study examined the influence advertising has on food choice of bank workers in Ghana. Whereas, there is a lot of empirical study on the influence of advertising on food choice in other countries, little is known about the phenomenon in Ghana, especially the influence of advertising on workers' food choice. The Uses and Gratification theory served as the lens for the study. Adopting the descriptive research design, we surveyed 200 respondents (bank workers) from 20 banks in the Central Region of Ghana, using convenience sampling procedure. Categories of food include fast foods, snacks, and food served in restaurants. The findings revealed that Television had the greatest influence on the food choice of respondents, followed by Radio. Taste was the highest influencing factor regarding bank workers' food choice. It was recommended that food advertisers must pay more attention to taste as a strong selling point when advertising their products.

*Keywords: advertising, food choice, taste, bank workers, media, Central Region, Ghana*

## **1 INTRODUCTION**

Consumers are exposed to a wide range of advertisements in different media everyday thereby making advertising, sales promotion and public relations essential mass-communication tools available to marketers. Advertising is a communication process, a marketing process, an economic and social process, a public relations process or an information and persuasion process (Kazmi & Batra, 2009; Arens, 1996). From its functional perspectives Dunn and Barban (1987) view advertising, as a paid, non-personal communication through various media by business firms, non-profit organization, and individuals who are in some way identified in the advertising message and who hope to inform or persuade members of an audience. Morden (1991) is of the opinion that advertising is used to establish a basic awareness of the product or service in the mind of the potential customer and to build up knowledge about it. Numerous products, including food products are presented to customers as well as potential customers through advertising.

Food is an integral part of daily life. It has a powerful effect on the health and well-being of consumers. International Labour Organisation's (ILO, 2019) report asserts that poor diet on the job is costing countries around the world up to 20 per cent in lost productivity, either due to malnutrition that plagues some one billion people in developing countries or the excess weight and obesity afflicting an equal number mostly in industrialized economies. The report notes that poor nourishment at the workplace can reduce productivity up to 20 percent, and this is obviously, a worrying situation.

Food choices are determined by a variety of factors including social class, time, preferences, cultural practices, media influences, and family structure. These dimensions and their factors are not only very large in number but possess influence that is complex in nature. The role of advertising in workers' choice of food has long been recognized as a significant factor. While diet fads, local and organic food movements saturate popular culture, food advertising seems to flood the media. This, compounded by money and time according to Reyes (2010), leads to a difference in dietary habits across society. Generally, food choices are apparently a class issue



because often, the least expensive food is, the least nutritious food is assumed to be, which according to Wright and Ransom (2005), leads to structural inequality in society. Devine et al. (2009), De Irala-Estevez et al. (2000) and Donkin et al. (2000) assert that while some workers may have the opportunity to make food choices, others do not even have the luxury to think about food choice because their main concern is if there is even going to be enough food to eat. According to Sizer and Whitney (2008), consumers today value convenience so highly that they are willing to spend over half of their food budget on meals that require little or no preparation. They regularly eat out, bring home ready-to-eat meals, or have food delivered to them. We are of the assumption that this trend is mainly influenced by the media which promotes such behaviours through advertisements and popular programs and movies, which leads us to the issue of exposure.

As opined by Caraher and Landon (2006), exposure to food advertisement is one of the powerful forces driving the relationship between screen time and obesity. According to Denton (2013), food is an important factor in the proper or improper functioning of the body. Eating the wrong food can make people become overweight, undernourished, and at risk for the development of diseases and conditions, such as arthritis, diabetes, and heart disease. Duffey (2013), Batada et al. (2008) and Karupaiah et al. (2008) assert that people are swamped with advertisements which tend to promote unhealthy foods and beverages. More specifically, exposure to advertising may alter people's food intake. According to Johnson and Cobb-Walgren (1994) and Kelly et al. (2011), television advertising remains the primary channel through which companies reach consumers. According to Lazzari and Seidel (2019), predominantly, television advertising is used to influence viewers' buying decisions. Encouragingly, a study by Duffey (2013) states that advertisements and key product placement can influence a person's preference for and consumption of healthier food items. Howard (2018) asserts that on the average, an estimated 36.6% or approximately 84.8 million adults in the United States of America consume fast foods.

Consumers make many product decisions every day based on their interests or desires as well as suggestions from others (Evans, Jamal & Foxall, 2009; Grunert, 2006). Advertisements make people aware of the products in the market. People are exposed to advertisements through billboards, television, product packaging and other media. According to Cheung et al. (2003) two factors that explain online consumer behaviour are: (1) consumer characteristics, including behavioural characteristics (looking for product information, access location, duration and frequency of usage) and experience; (2) environmental influences, like social, peer and mass media influences, which play important roles in affecting consumers' purchasing decisions. There is a significant gap in scientific inquiry into advertising and its relationship with food choice of workers in Ghana. With the underlying assumption that advertising plays a significant role in influencing the food choice of workers and since research on the subject matter is scanty in Ghana, the present study is deemed necessary.

Gender in advertising has been studied by scholars globally. Kappele (2015), Brooks and Hébert (2006), and Gerbner (1993) found forms of sexism in the way gender, regarding females are represented in the media, especially, in advertisements. Manippa et al. (2017) studied gender differences regarding food choice and found that generally, males preferred low calorie foods than females. Rickett (2014) and Wardle et al. (2004) opines assert that advertisers still use stereotypical stands in advertising, since food advertisements target women by exploring the taste factor while stressing less on calories. The purpose of the study is to assess the relationship between the nature of food advertisements on one hand and their relationship with the choice of food of bank workers in the Central Region of Ghana on another hand. It is also aimed at finding the nature of advertisement as well as the motivation behind the food choices of bank workers in the Central Region of Ghana.

The study was directed by research questions and hypotheses. The following research questions were formulated: (1) What is the perception of bank workers in the Central Region of Ghana on the influence of advertising on their food choices?; (2) How frequent do bank workers in the Central Region of Ghana patronise fast foods? The following Hypotheses were tested: (1) There are significant gender differences in the advertising medium that influences bank workers' food choice in the Central Region of Ghana; (2) There is no significant gender difference in the factors that motivate bank workers in Central Region of Ghana to make their food choices.

The study is organised into four main areas. First, the theoretical framework that guides the study is discussed, followed by the method used to achieve the results. Thirdly, the results and discussion section is presented followed by the conclusions and recommendations.

## **2 THEORETICAL FRAMEWORK**

From the perspective of the functionalist regarding mass communication, the Uses and Gratification (U&G) theory originated. The pioneering rights of Uses and Gratification theory can be attributed to Katz, Blumler and Gurevitch in 1974. According to Ruggiero (2000), U&G may be characterized by an inductive method for developing the nomenclature of different motivations and functions of media use. Basically, the assumption of U&G is that people are actively involved in the use of media for their purposes, and these people have high interactions with the communication media by building profile groupings of related uses and theoretically associated gratifications (Luo, 2002). The theory traces why consumers use media and what functions that media serves for them (Katerattanakul, 2002). According to McQuail (2010), initially, U&G was developed in research on the effectiveness and efficiency of radio in the 1940s. The focus of U&G is mainly on the explanations for the motivations and associated behaviours of audience members.

Scholars have employed U&G to their studies. Example, Weiyang (2015) explores how U&G variables affect audience satisfaction Internet Protocol Television (IPTV) and asserts that the introduction of computer-mediated communication has given new life to the significance of uses and gratifications theory. Hedstrom (2014) examines media use and diet by employing uses and gratification theory, when he tested and quantified moderating effects of emotional eating on the interaction between emotional needs and media use and finds significant effects of emotional eating. Klimsa (2010), in a study to bring clarity on the motives, attitudes, and obtained gratifications that people derive from online advertisements found that the meeting point of uses and gratifications theory and online marketing leads to profitability. Luo (2002) also finds that the perception of the web by Internet users as entertaining and informative generally show a positive attitude toward the Internet. In order to examine the relationship between advertisements (radio, TV, etc.) and workers' food choice, Uses and Gratification theory is appropriate.

## **3 METHOD**

We adopted the descriptive research design. The population comprised bank workers specifically from the banks in the major towns and cities within the Central Region of Ghana. A sample size of 200 respondents from 20 selected banks in the Central Region was used for the study. The simple random and convenience sampling procedures were used. The simple random sampling technique was used in selecting the banks. The respondents from these banks were selected using the convenience sampling technique. In using convenience sampling to select the respondents, we went to various banks and sought the consent of staff available to provide responses for the study. The main research instrument used was the 'Food Choice Survey', a questionnaire designed by the researchers. The instrument was pilot tested on 20

bank workers in the Greater-Accra Region of Ghana because they have similar characteristics with those in the Central Region. Reliability was established using the Cronbach Alpha reliability coefficient. Reliability of the instrument was undertaken to find out the precision, consistency and stability of a score from the instrument. The overall reliability coefficient from the pilot test was .89.

### 3.1 Data Collection Procedure

The questionnaires were hand-delivered to the respondents, who were briefed on how to respond to the items. Also, respondents were given the opportunity to ask questions to clarify issues they did not understand. The questionnaires were collected a week after they had been distributed. This was to ensure that the respondents had enough time to complete the questions.

### 3.2 Data Analysis Procedure

The information gathered in the study was analysed using SPSS statistics. Serial and code numbers were assigned to each item on the questionnaire for easy identification before scoring them. Frequencies and percentages were used to answer the research questions. The Hypotheses were tested using t-test analysis. Based on a three-point Likert type scale, the mean scores were categorised as follows: Agree - 1.0-1.5; Disagree - 1.6-2.0; Not sure - 2.1-2.6. As such a mean of 1.5 and below shows that respondents strongly agreed with the item.

## 4 RESULTS AND DISCUSSION

This section presents the results of the study and discusses the findings from the data collected. The discussion is done under the various research questions and hypotheses.

### RQ 1: What is the perception of bank workers in the Central Region of Ghana on the influence of advertising on their food choices?

Tab. 1 – Perception of Bank Workers on Influence of Advertising on their Food Choices. Source: own research

Statement	Agree Frequency	%	Disagree Frequency	%	Not Sure Frequency	%
Adverts make me eat healthy foods	33	16.5	167	83.5	-	-
Adverts make me eat unhealthy foods	46	23	145	72.5	9	4.5
Adverts influence my food choices	18	9	174	87	8	4
Without adverts, I will not be able to make good food choices	22	11	178	89	-	-
The main determinant of my food choice is advertisement	6	3	194	97	-	-
My food preferences are based on advertisements	7	3.5	193	96.5	-	-
Television advertisements have strong influences on my food choices	104	52	96	48	-	-
Newspaper adverts affect my food choice	81	40.5	113	56.5	6	3
I would eat healthy whether there are adverts on foods or not	192	96	8	4	-	-

Table 1 shows that more than half of respondents (174 out of 200) representing 87% expressed the view that advertisements do not influence their choice of food. Also, 167 respondents, representing 83.5% disagree that advertisements influence their healthy eating. This finding is in sharp contrast to Duffey (2013), which indicated that advertisements influence a person's preference for and consumption of food items. This sharp contrast could probably be so, since Duffey's study considered a target group (children) that is sharply different from the group our study considered. Also, we observed that all the 20 banks sampled had television sets fitted in

the banking halls. This may have contributed to the reason why a slight majority (104) agreed that they are influenced by television advertisements, since they are exposed to advertisements on television at work. However, the finding confirms Johnson and Cobb-Walgren (1994) and Kelly et al. (2011), who found that television is the primary medium through which advertisers reach their target.

**RQ 2: How frequent do bank workers in the Central Region of Ghana patronise fast foods?**

Tab. 2 – Weekly Eating Frequency of Fast Food Meals. Source: own research

Number of Times	Number of Respondents	Percentage
None	9	4.5
1-3	140	70.0
4-6	43	21.5
7-10	8	4.0
<b>Total</b>	<b>200</b>	<b>100</b>

Table 2 indicates that majority (70%) of the respondents eat fast foods one to three times a week while 30% patronize fast foods four to six times weekly. Just five percent eat fast foods 7-10 times weekly. For the purpose of precision fast foods are characterized as quick, easily accessible and cheap alternatives to home-cooked meals. Even though respondents who patronise fast foods many times in a week are in the minority, those who eat fast foods four to six times in a week (43 out of 200) represent second highest figure. This could be attributed to the fact that this category of workers is largely, not influenced by advertisements regarding food choice. This finding is closely related to Howard (2018), who found that averagely, an estimated 36.6% or approximately 84.8 million adults consume fast food daily in the United States of America.

**RH 1: H1: There are significant gender differences in the advertising medium that influences bank workers’ food choice in the Central Region of Ghana.**

Tab. 3 – t-test on Gender Differences and Advertising Media. Source: own research

Media	Gender	N	Mean	S.D.	t	df	Sig.
Television	Male	98	1.55	.628	-.819	198	.290
	Female	102	1.63	.688			
Radio	Male	98	1.87	.568	.179	198	.842
	Female	102	1.85	.570			
Internet	Male	98	1.83	.381	-.908	198	.069
	Female	102	1.87	.335			
Billboard	Male	98	1.97	.392	-1.564	198	.524
	Female	102	2.05	.326			
Magazine	Male	98	2.06	.450	.043	198	.083
	Female	102	2.06	.340			
Newspaper	Male	98	1.94	.241	2.176	198	.000
	Female	102	1.84	.365			

Table 3 presents the t-test results on gender differences and advertising media at an alpha level of 0.05. Table 3 shows that there were no significant differences in five of the media (namely television, radio, internet, billboard and magazine). It can be observed that, regarding newspaper, there was a significant difference (.000) between males and females. As indicated earlier, a mean of 1.5 and below signals a more popular choice. The means show that majority of the respondents considered Television to be the medium that had the greatest influence on

their food choice (1.51 for males and 1.48 for females). In order of the most influencers, Radio was the next preferred option, then Internet, Newspaper, Billboard and Magazine. On some of the items, the males had lower means than the females which showed they preferred the item relatively more than the females and vice versa. Males preferred Radio, Internet, Billboard and Magazine while females preferred Television and Newspaper. In general, Newspapers, Magazines and Billboards were reported to have the least influence on the choice of food of bank workers regardless of gender. In general, due to the result obtained, research hypothesis one is rejected.

To support the finding of television being the most influencing medium, Duffey (2013) noted that television advertising remains the primary channel through which companies reach consumers. This finding is also corroborated by Johnson and Cobb-Walgren (1994) and Kelly et al. (2011). We assume that television being audio-visual medium may be a contributing factor to this finding. This is because television audience would not only listen to sound as in Radio, but see visuals (both still and motion).

**RH 2: H1: There are significant gender differences in the factors that motivate middle-class workers’ in Central Region of Ghana to make their food choices.**

Tab. 4 – t-test on Gender Differences and Motivating Factors. Source: own research

Motivating factor	Gender	N	Mean	S.D.	t	df	Sig.
Convenience	Male	98	1.94	.534	1.94	198	.840
	Female	102	1.94	.523			
Taste	Male	98	1.54	.501	1.54	198	.618
	Female	102	1.56	.499			
Preference	Male	98	1.95	.563	1.95	198	.802
	Female	102	1.88	.532			
Time	Male	98	1.96	.555	1.96	198	.079
	Female	102	1.97	.455			
Money	Male	98	1.87	.620	1.87	198	.523
	Female	102	1.83	.564			
Adverts	Male	98	2.06	.450	2.06	198	.143
	Female	102	2.02	.398			

Table 4 presents the results based on an independent samples t-test analysis at an alpha level of 0.05. Table 4 shows that there were significant gender differences regarding Preference, Time and Money. Also, majority of the respondents noted that “Taste” was the most influencing factor in determining their food choice (1.33 for males and 1.30 for females). In order of the most motivating factors, Money was the next, followed by Preference, Time, Convenience and Adverts. On most of the items, the females had lower means than the males which showed they preferred the item relatively more than the males. Females considered Taste, Preference, Time and Adverts as motivating more than the males. Regarding convenience both males and females had the same means. Due to the result obtained, hypothesis two is retained.

The finding of taste been the most influencing factor seems to confirm the European Food Information Council (IFIC, 2011) which noted that ‘taste’ is consistently reported as a major influence on food behaviour. A liking for sweetness and a dislike for bitterness are considered innate human traits, present from birth. ‘Taste’ is the sum of all sensory stimulation that is produced by the ingestion of a food. This includes not only taste per se but also smell, appearance and texture of food. These sensory aspects are thought to influence spontaneous food choice. Again, in relation to the finding that money was also a great influencing factor for

food choice, the study confirms De Irala-Estevez et al. (2000), who reported that the cost of food is a primary determinant of food choice. Whether cost is prohibitive depends fundamentally on a person's income and socio-economic status. However, it must be noted that access to more money does not automatically equate to a better-quality diet but only increases the range of foods from which one can choose. Similarly, a survey by the International Food Information Council (IFIC, 2011) Foundation asked 1,000 Americans about their habits when it comes to food choices. Taste ranked number one for most (87%), but price quickly caught up. In fact, the cost of food was said to be the fastest-growing determinant of food choice. In the study, 79% of people said price affects their food choices.

Supporting Preference and Time as motivating factors, Donkin et al. (2000), who identified time factor which includes accessibility to shops as an important physical factor influencing food choice. They further noted that it is dependent on resources such as transport and geographical location. Preference may be an important factor probably because it is dependent on taste of food (which is the most influencing factor).

Relatively, convenience and advertisements were reported to be the least influencing factors in the determination of the food choice of bank workers in the Central Region of Ghana. This finding is contrary to Sizer and Whitney (2008) who reported that consumers today value convenience so highly that they are willing to spend over half of their food budget on meals that require little or no preparation. They regularly eat out, bring home ready-to-eat meals, or have food delivered to them. This trend is mainly influenced by the media which promote such behaviours through commercials and popular programmes and movies. Grunert (2006), an American researcher noted that the most important aspect of marketing in the consumer's perspective is convenience. He further noted that the problem with these convenience foods, is that they are typically not nutritious in any way, shape, or form, and are usually high in fat, calories, and carbohydrates. This could probably be the reason why convenience is not a strong influencing factor identified by this study.

Regarding gender differences in making food choice, Wardle et al. (2004), in examining food choice behaviours among young adults found that women generally avoid fatty foods as compared to men. They also found that women paid more attention to healthy eating as compared to men.

## **5 IMPLICATIONS**

The practical implication of the study is that advertisers as well as advertising practitioners, especially copywriters for food advertisements must pay more attention to taste when writing copies targeted at workers in Ghana, since taste proved to be the highest influencing factor. Also, Television proved to have the greatest influence on the food choice of bank workers in Ghana, hence media planners must be more strategic and consider placing food advertisements on television.

## **6 CONCLUSIONS & RECOMMENDATIONS**

We sought to examine the influence of advertising on food choice of bank workers in the Central Region of Ghana. Regarding theory, the study expands the frontiers of the Uses and Gratification theory by demonstrating how bank workers use media as well as advertising and its effect on bank workers' food choice in Ghana. With the busy nature of respondents (bank workers) sampled and the assumption that they would be easily influenced by advertisements in making their food choice, since they do not have the luxury of time to prepare their own meals, the findings reveal slightly otherwise. The findings of this study are revealing, although

generalisation must be done with caution, since it was conducted in only one region out of the sixteen regions of Ghana. This notwithstanding, however, the findings apply to bank workers in Ghana. It is instructive to note that food advertisements have some influence, but minimal, on the food choice bank workers in Ghana. The next stage of our study will broaden the scope to capture all sixteen regions in Ghana, as well as include more variables such as Word of Mouth (WoM).

We recommend that advertisers and advertising executives must put more effort into their messaging strategy regarding food ads, by paying more attention to taste of food as well as cost of food in order to guarantee maximum impact of ads.

## References

- Arens, W. F. (1996). *Contemporary advertising*. New York: McGraw-Hill.
- Batada, A., Seitz, M. D., Wootan, M. G., & Story, M. (2008). Nine out of 10 food advertisements shown during Saturday morning children's television programming are for foods high in fat, sodium, or added sugars, or low in nutrients. *Journal of the American Dietetic Association*, 108(4), 673-678. doi: 10.1016/j.jada.2008.01.015
- Brooks, D. E., & Hébert, L. P. (2006). Gender, race, and media representation. In B. J. Dow & J. T. Wood, *The SAGE Handbook of Gender and Communication*. London: SAGE. doi: 10.4135/9781412976053.n16
- Caraher, M., & Landon, J. (2006). The impact of advertising on food choice: The social context of advertising. In R. Shepherd & M. Raats (eds.), *The Psychology of Food Choice: Frontiers in nutritional science*. Wallingford: CABI. doi: 10.1079/PHN2005879
- Cheung, C. M. K., Zhu, L., Kwong, T., Chan, G. W. W., & Moez, L. (2003) Online Consumer Behaviour: A Review and Agenda for Future Research. Paper presented at The 16th Bled eCommerce Conference eTransformation, Bled, Slovenia. Retrieved from <https://aisel.aisnet.org/cgi/viewcontent.cgi?article=1112&context=bled2003>
- De Irala-Estevez, J., Groth, M., Johansson, L., Oltersdorf, U., Prättälä, R., & Martínez-González, M. A. (2000). A systematic review of socio-economic differences in food habits in Europe: consumption of fruit and vegetables. *European journal of clinical nutrition*, 54(9), 706-714. doi: 10.1038/sj.ejcn.1601080
- Denton, C. L. N. (2013). *How does food impact health*. Regents of the University of Minnesota. Retrieved from <http://www.takingcharge.csh.umn.edu/explore-healing-practices/food-medicine/how-does-food-impact-health>
- Devine, C. M., Farrell, T., Blake, C. E., Jastran, M., Wethington, E., & Bisogni, C. A. (2009). Work Conditions and the Food Choice Coping Strategies of Employed Parents. *Journal of Nutrition Education and Behaviour*, 41(5), 365-370. doi: 10.1016/j.jneb.2009.01.007
- Donkin, A. J., Dowler, E. A., Stevenson, S. J., & Turner, S. A. (2000). Mapping access to food in a deprived area: The development of price and availability indices. *Public Health Nutrition*, 3(1), 31-38. doi: 10.1017/s1368980000000057
- Duffey, K. (2013). *Food on the brain: How advertising can influence your child's diet*. Retrieved from [www.ourregularlyscheduledprogram.com](http://www.ourregularlyscheduledprogram.com)
- Dunn, S. W., & Barban, A. (1987). *Advertising, it's role in modern marketing advertising*. Hindsdale: Dryden Press.
- Evans, M., Jamal, A., & Foxall, G., (2009). *Consumer behaviour*. Ney York: Wiley.

- Gerbner, G. (1993). *Women and minorities on television: A study in casting and fate*. Philadelphia: University of Pennsylvania.
- Grunert, K. G. (2006). *Marketing parameters and their influence on consumer food choice*. Wallingford: CABI.
- Hedstrom, A. E. (2014). *Media use and diet: A dynamic uses and gratifications approach*. Columbus: The Ohio State University.
- Howard, J. (2018). *Here's how much fast food Americans are eating*. Retrieved from <https://edition.cnn.com/2018/10/03/health/fast-food-consumption-cdc-study/index.html>
- IFIC (2011). *International Food Information Council Foundation Releases Its 2011 Food & Health Survey*. Retrieved from <https://foodinsight.org/international-food-information-council-foundation-releases-its-2011-food-health-survey/>
- ILO (2019). *Poor workplace nutrition hits workers' health and productivity*. Retrieved from [https://www.ilo.org/global/about-the-ilo/newsroom/news/WCMS\\_005175/lang--en/index.htm](https://www.ilo.org/global/about-the-ilo/newsroom/news/WCMS_005175/lang--en/index.htm)
- Johnson, R. L., & Cobb-Walgren, C. J. (1994). Aging and the problem of television clutter. *Journal of Advertising Research*, 34(4), 54-63. Retrieved from <https://psycnet.apa.org/record/1995-23466-001>
- Katerattanakul, P. (2002). Framework of effective web site design for business-to-consumer internet commerce. *INFOR: Information Systems and Operational Research*, 40(1), 57-70. doi: 10.1080/03155986.2002.11732641
- Karupaiah, T., Chinna, K., Mee, L. H., Mei, L. S., & Noor, M. I. (2008). What's on Malaysian television? A survey on food advertising targeting children. *Asia Pacific Journal of Clinical Nutrition*, 17(3), 71 - 84. Retrieved from [https://www.researchgate.net/publication/23281734\\_What's\\_on\\_Malaysian\\_Television\\_-\\_A\\_survey\\_on\\_food\\_advertising\\_targeting\\_children](https://www.researchgate.net/publication/23281734_What's_on_Malaysian_Television_-_A_survey_on_food_advertising_targeting_children)
- Kappele, A. E. (2015). *The role of gender representations on craft beer labels*. Columbia: University of Missouri.
- Kazmi, S. H. H., & Batra, S. K. (2009). *Advertising and Sales Promotion*. New Delhi: Excel Books.
- Kelly, B., Chapman, K., King, L., & Hebden, L. (2011). Trends in food advertising to children on free-to-air television in Australia. *Australian and New Zealand journal of public health*, 35(2), 131-134. doi: 10.1111/j.1753-6405.2011.00612.x
- Klimsa, P. (2010). *Uses and gratifications of online advertising*. Ilmenau: Technical University.
- Lazzari, Z. & Seidel, M. (2019). *The Influence of television advertising*. Retrieved from <https://smallbusiness.chron.com/influence-television-advertising-64010.html>
- Luo, X. (2002). Uses and gratifications theory and e-consumer behaviors: a structural equation modeling study. *Journal of Interactive advertising*, 2(2), 34-41. doi: 10.1080/15252019.2002.10722060
- Manippa, V., Padulo, C., van der Laan, L. N., & Brancucci, A. (2017). Gender differences in food choice: effects of superior temporal sulcus stimulation. *Frontiers in human neuroscience*, 11, 597. doi: 10.3389/fnhum.2017.00597
- McQuail, D. (2010). *McQuail's mass communication theory*. London: SAGE.



- Morden, A. R. (1991). *Elements of marketing*. London: D.P. Publication.
- Reyes, A. M. (2010). *Influences on college students' eating habits*. Tucson: University of Arizona.
- Rickett, O. (2014). *Food advertising is still feeding gender stereotypes*. Retrieved from [https://www.vice.com/en\\_us/article/d75nvk/food-advertising-is-still-feeding-gender-stereotypes](https://www.vice.com/en_us/article/d75nvk/food-advertising-is-still-feeding-gender-stereotypes)
- Ruggiero, T. E. (2000). Uses and gratifications theory in the 21st century. *Mass communication & society*, 3(1), 3-37. doi: 10.1080/08838151.2013.845827
- Sizer, F. S & Whitney, E. (2008). *Nutrition: Concepts and controversies*. Boston: Cengage Learning.
- Wardle, J., Haase, A. M., Steptoe, A., Nillapun, M., Jonwutiwes, K., & Bellis, F. (2004). Gender differences in food choice: the contribution of health beliefs and dieting. *Annals of behavioural medicine*, 27(2), 107-116. doi: 10.1207/s15324796abm2702\_5
- Weiyang, L. I. U. (2015). A historical overview of uses and gratifications theory. *Cross-Cultural Communication*, 11(9), 71-78. doi: 10.3968/7415
- Wright, W., & Ransom, E. (2005). Stratification on the menu: Using restaurant menus to examine social class. *Teaching Sociology*, 33(3), 310-316. doi: 10.1177/0092055x0503300311

## Contact information

### **Daniel Edem Adzovie**

Tomas Bata University in Zlín, Faculty of Multimedia Communications  
Univerzitní 2431, 76001, Zlín, Czech Republic  
E-mail: [adzovie@utb.cz](mailto:adzovie@utb.cz)  
ORCID: 0000-0001-5553-5705

### **Eunice Eshun**

University of Cape Coast, Faculty of Arts  
Cape Coast, Ghana  
E-mail: [eunice.eshun@ucc.edu.gh](mailto:eunice.eshun@ucc.edu.gh)  
ORCID: 0000-0001-6146-3306

### **Prof. Philip Arthur Gborsong**

University of Cape Coast, Faculty of Arts  
Cape Coast, Ghana  
E-mail: [pgborsong@ucc.edu.gh](mailto:pgborsong@ucc.edu.gh)  
ORCID: 0000-0003-1819-7844

doi: 10.7441/dokbat.2019.001

# LEADER'S ENVY AND KNOWLEDGE HIDING IN UNIVERSITIES IN PAKISTAN

*Moazzam Ali, Muhammad Usman, Nhat Tan Pham*

## **Abstract**

The present study examines the role of the leader's envy in knowledge hiding. Based on 28 semi-structured interviews from the faculty members of different Universities in Pakistan, we explain that how leader's perception of relative power as compare to their followers lead them to get envious of their followers and results in negative behaviours, such as knowledge hiding. Furthermore, this paper attempts to explain when such phenomenon exists in a work setting, and what kind of knowledge-hiding behaviours – rationalized hiding, evasive hiding, or playing dumb – leaders demonstrate. Results show that as a result of social comparisons with competent subordinates, leaders engage in the feeling of envy. As a behavioural response of envy, leaders engage in different knowledge-hiding behaviours.

*Keywords: Knowledge hiding, rationalized hiding, evasive hiding, playing dumb*

## **1 INTRODUCTION**

Many years of research has established the significance of leadership for people, groups, associations, and organizations in general (Jung & Sosik, 2002). Different attributes, attitudes, and behaviours of leader have been linked with various type of organizational behaviours and outcomes like organizational citizenship behaviour, job performance, job satisfaction, job commitment, employee's turnover, etc. (Brooke, 2006; Babcock-Roberson & Strickland, 2010). Leadership has been studied from the follower's perspective. Literature suggests that leadership supports, motivates, and directs followers towards the achievement of organizational goals (Keskes, 2014). Followers' characteristics such as initiative, likeability, and competence have been revealed to have positive effects on leader's emotions and behaviours, thus resulting in a positive relationship between leader and his followers (Newcombe & Ashkanasy, 2002). While it has been studied that leaders are envied because of the power and influence they have (Stein, 1997), empirical studies that explore what happens when leaders themselves are subjected to the feelings of envy are scarce. It is assumed that leaders feel confident in their hierarchical position and are usually unthreatened by their followers because of the power they hold over them (Elfenbein, Eisenkraft & Ding, 2009). But in today's dynamic business context where change is the only constant thing, leaders are also concerned about their job security. Leaders might see their followers as their competitors.

Leadership literature has put too much focus on the positive and negative sides of leadership, while these perspectives are significant and have improved the leadership literature, they have neglected to think about leaders in general as entire and entangled people with instabilities, shortcomings, clashing arrangements of thought processes and feelings (Leheta, Dimotakis & Schatten, 2016). Leaders can see competent followers as potential competitors for their leadership position and social status. Due to this factor, leaders view the accomplishments of followers as a threat to their comparative standing. When leaders see their followers as their competitors, they envy them. Envy is defined as "an unpleasant, often painful emotion characterized by feelings of inferiority, hostility, and resentment caused by an awareness of the desired attribute enjoyed by another person or group of persons" (Smith & Kim, 2007). This

feeling of envy is drawn from social comparison theory (Suls & Wheeler, 2013). Unfavorable social comparisons with followers result in envious feelings toward them.

Leader's envy further leads to many negative attitudes and behaviours towards his followers. How leaders respond to the one he/she envies depends on their personality type. For one leader, it may motivate one to strive to secure one's position if one considers one's follower as a threat to one's position; whereas another leader may indulge in negative behaviour and would try to undermine the efforts of one's follower who one sees as a threat. These negative attitudes and behaviours can range from bullying, discouraging to lack of response. One of these negative attitudes can be the unwillingness to share knowledge with those who are being envied (Tai, Narayanan & McAllister, 2012).

Organizations make a huge effort and invest tremendously to channelize knowledge and share it across the organization, as for many organizations, knowledge is a resource that can help organizations gain sustained comparative advantage (Janz & Prasarnphanich, 2003). Organizational practices usually encourage knowledge sharing among organizational employees, although it is very difficult as people in general hoard knowledge for one reason or another (Bartol & Srivastava, 2002). To cope with this challenge, researchers have explored various strategies, which encourage knowledge sharing among employees, like the use of incentives, how knowledge sharing can be beneficial for one's reputation and self-image (Wasko, 2005). Although there is an extensive amount of research done to emphasize on knowledge sharing, what makes employees hide knowledge from their fellow organizational members is yet unexplored. Knowledge hiding is a conscious effort to hoard knowledge when someone has requested it (Connelly et al., 2012). Peng (2013) has attributed knowledge hiding to its psychological ownership, as employees consider knowledge as their property, which leads them to indulge in knowledge hiding.

Research has been conducted by a variety of authors on why and when employees hide knowledge from their fellow employees, but why leaders hide knowledge from their followers has not been yet explored. On the other hand, leadership envy is relatively a new construct, its causes and consequences have been explored (Leheta, Dimotakis & Schatten, 2016) and in this study, we will investigate the link between leader's envy and knowledge hiding. We will establish how leader's envy make leaders engage in behaviour which instead of empowering competent employees, that undermine their potential. There can be a variety of resultant behaviours, but in this study, we will focus on knowledge hiding as in today's dynamic business world, knowledge is considered as a corporate resource. Organizations invest a huge amount of financial and human resources to ensure the effective management of knowledge, as it is the key to secure comparative standing, knowledge hiding can have detrimental effects on such organizational objectives especially when it is done by the leaders who have power and influence over many.

In essence, the present study aims to explore how social comparison with subordinates make a leader indulge in the feeling of envy and consequently engage in knowledge-hiding behaviour. This research contributes to the existing body of literature in two ways. First, it explores the human side of the leader, that leaders like others are also subjected to the feelings of envy. Secondly, it examines that when leaders are envious of their followers, how they began to hide knowledge from them.

## **2 THEORETICAL BACKGROUND**

### **2.1 Leader's Envy: A new perspective in organizational behaviour**

Envy has long been a subject of interest in psychological and behavioural sciences. Schoeck (1969) describes envy in his book as “Envy is a drive which lies at the core of man’s life as a social being, which occurs as soon as two individuals become capable of mutual comparison”. It is drawn from social comparison with other beings in society. It has been defined as a distinct and negative feeling, which has the potential to affect the human relationship (Thompson, Glasø & Martinsen, 2015). While there have been decades of research conducted on envy by psychologist and anthropologist, it has got little attention in the domain of organizational behaviour (Ozkoc & Caliskan, 2015). There can be two factors that trigger the feeling of envy in people in an organization: 1) the personal characteristics of the beholder like lack of confidence; and 2) situational factors prevailing in an organization such as competition, promotion, and downsizing (Cooper & Payne, 1989).

A limited number of studies which have been conducted on envy in organizational setting focuses on the envious relationship between employees of same hierarchal position (Bedeian, 1995; Ozkoc & Caliskan, 2015; Menon & Thompson, 2010). There are very few which have studied this construct in a leader-follower relationship, even those few studies have studied envy on the part of follower, as they might get envious of their leader’s power and influence (Stein, 1997; Kets de Vries, 1994). Leaders getting envious of their followers’ competence is an unexplored construct (Leheta, Dimotakis & Schatten, 2016). As the construct of envy is drawn from the social comparison theory, leader’s envy can be a result of social comparison with their followers in terms of power (Dijkstra, 2011).

### **2.2 Knowledge Hiding**

Connelly et al. (2012) define knowledge hiding as “an intentional attempt by an individual to withhold or conceal knowledge that has been requested by another person”. While researchers have conducted many studies to explore and examine the factors which might enhance knowledge sharing among employees (Husted et al., 2012), what causes employees to hide knowledge is yet unexplored (Connelly et al., 2012). Knowledge hiding is different from knowledge hoarding, as knowledge hoarding is withholding knowledge before anyone’s request for it, it is to gather knowledge that may or may not be shared in future (Hislop, 2003). Knowledge hiding is a conscious effort to hide knowledge when somebody is requesting for it. Knowledge hiding is not even lack of knowledge sharing, as lack of knowledge sharing might mean the absence of knowledge, whereas knowledge hiding is concealing the knowledge that (Connelly et al., 2012).

Knowledge hiding behaviours are manifested in organizations and reveal that engaging in hiding is not merely the refusal to transfer knowledge. People can take on different strategies to hide knowledge. Connelly et al. (2012) had identified its three forms; playing dumb, rationalized hiding, and evasive hiding. In playing dumb, the hider pretends that he/she does not know the requested information. Evasive hiding involves providing only a part of the requested information or agreeing to give the information but stalling it. Rationalized hiding involves declining the request of the knowledge seeker by blaming it on the third party, such as saying that this information is confidential (Connelly et al., 2012). There can be multiple reasons for hiding knowledge, which can range from interpersonal relationships to organization knowledge-sharing climate. (Connelly et al., 2012). The present study aims to explore the role of the leader’s envy in predicting knowledge hiding.

### **2.3 Leader's Envy and Knowledge Hiding**

When individuals begin envying people around them, it incites a variety of responses, both negative and positive (Alicke & Zell, 2008). Envy has earned consideration as a feeling of interest since old times. For instance, Socrates states in Plato's *Philebus* that “envy has been acknowledged by us to be mental pain” (Plato 360 BCE/2007). Nonetheless, as indicated by the customary definitions of envy, it doesn't simply involve feeling tormented at another person's favourable circumstances and fortune, but at the same time is related with the malignant desire to withdraw the envied of their advantage, regardless of the appropriate means through which envied has attained that standpoint. (Smith, 2008). One example of such behaviour is envy's unwillingness to share information and knowledge with the one envied (Tai, Narayanan & McAllister, 2012). Similarly, in leader's envy leader might withhold the knowledge required and requested by his/her follower with the intention to deprive the envied of their advantage.

Agency theory proposes that individuals are usually directed by their self-interest, even if it involves harming others (Eisenhardt, 1989). Such is the case with knowledge sharing behaviours of employees in a workplace; they evaluate the advantages and disadvantages of knowledge sharing and act accordingly. Employees might hide knowledge from competing colleagues as they might see sharing knowledge as detrimental to their performance (Bartol & Sariastava, 2002). This can be true for those leaders who envy the increased performance of their followers, as they might assume that sharing knowledge with such followers can potentially undermine the leaders' performance.

Connelly et al. (2012) found that competition is a driving force in lack of knowledge sharing. They concluded that individuals who try to maximize their performance to survive in a competitive organization environment would dedicate all available resources, including time in the pursuit of their goals. Thus, sharing knowledge might be considered a time-consuming task (Connelly et al., 2012). Leaders who see their followers as their competitors are more likely to be unwilling to share knowledge or necessary information with them.

Tesser & Smith (1980) identified the various consequences of envy, one of which is the envier's attempts to prevent envied from success. Leaders are in the position to exercise authority and control over their subordinates (Collinson, 2005). When they envy their subordinates, there are several ways in which they can put obstacles in the way of subordinates' successful performance. One significant hindrance is to hide the necessary information required to carry out their workplace tasks.

## **3 RESEARCH METHODOLOGY**

### **3.1 Qualitative Approach**

The research design for the present study involves the use of qualitative research methodology. Qualitative research has strength for offering “the greatest promise of making significant contributions to the knowledge base and practice of education,” because it is “focused on discovery, insight, and understanding from the perspective of those being studied” (Merriam, 1998). The methodology involves the examination of the perception of the employee who has been envied by their leaders. This qualitative research methodology is appropriate for the present study because there are multiple perspectives about the world (Rossman & Rallis, 2003). By exploring the perceptions of the employees who are envied by their leader, it is possible to get different perspectives that can enhance our understanding of the links between leader envy and knowledge hiding.

The research question of this study is centred on the definition and perspective of the follower's experience of a leader's envy and the resulting behaviour of knowledge hiding. The strategy acquired for inquiring the research question is biographical research. Biographical research is defined as "the study of an individual and her or his experiences as told to the researcher or found in documents and archival material" (Creswell, 1998). By examining the perception of employees being envied, it is important to determine the relative effect of leader's envy on knowledge hiding.

### 3.2 Sampling and data collection

Different sampling procedures are available for qualitative research. In the present study, criterion sampling is used. Criterion sampling requires studying and examining "all cases that meet some predetermined criterion of importance" (Patton, 2002). The criterion for this research is the participant's experience of being envied to better understand the relationship between a leader's envy and resultant knowledge hiding. As it is assumed that envy is drawn from social comparison theory (Suls & Wheeler, 2013), participant of this study needed to be competent enough to trigger the feeling of envy in his/her boss. For this purpose, we conducted 28 semi-structured interviews from the faculty members of different Universities in Pakistan. All the participants were informed about the nature and purpose of the study. The informants gave written consent, and they were ascertained that anonymity would be ensured. The participants were also informed that they could skip any question and leave the interview at any stage if they wish so. The average duration of the interviews was 90 minutes. All the interviews were audio-recorded.

### 3.3 Measurement of Leader's Envy

Measuring feeling of envy can be extremely challenging as social desirability and drive to conceal such feelings can pose measurement issues in assessing it (McGrath, 2011). General affective indicators have been used to assess the envy, such as feeling of being mediocre, dissatisfaction with one's self (Parrott & Smith, 1993). Van de Ven, Zeelenberg and Pieters (2009) has suggested a more comprehensive approach to assess the feeling of envy, it includes five components; feelings, thoughts, action tendencies, actions, and motivational goals. For the present study, we take five components model by Van de Ven, Zeelenberg and Pieters (2009) to assess the phenomenon of envy. Table 1 shows the five components and associated questions asked from the envied follower.

Tab. 1 – Semi Structured Question of Construct 1. Source: own research

Construct (Leader's Envy)	Questions
Feelings	Do you believe that your boss has a feeling of resentment towards you? Do you think that your accomplishments annoy your boss? Do you believe that your boss dislikes you in particular because of your career advancement?
Thoughts	Do you believe that your boss sees you as a threat to his position? Do you feel that your boss thinks that you do not deserve the position you hold in your organization?
Action Tendencies	Does your boss want to degrade you? Does he often try to undermine your efforts? Such as looking for flaws in specifically your work.
Actions	Does your boss give you unrealistic deadlines/targets? Does he intentionally put hurdles in your way to meet your target?
Motivational goals	Do you feel that your boss wants to see you fail in your career life?

### 3.4 Measurement of Knowledge Hiding

To measure knowledge hiding, items that define various types of knowledge hiding such as playing dumb, rationalized hiding and evasive hiding were used from Connelly’s model of knowledge hiding (Connelly et al., 2012). The semi-structured questions asked from the envied employee are shown in Table 2. To measure the leader’s envy and knowledge hiding, questions were interviewed from the envied employee/follower as this study involved the exploration of the leader’s envy- knowledge hiding relationship based on envied perception.

Tab. 2 – Semi-Structured Questions of Construct 2. Source: own research

Construct (Knowledge Hiding)	Questions
Playing Dumb	When you ask for certain information, your boss pretends that he/she does not know your query? Pretends that he/she doesn’t know what you are asking?
Evasive Hiding	Does your boss agree to help you but never does it? When he agrees to help you, does he give relevant information? When he agrees to help you, does he try to stall it as much as possible?
Rationalized Hiding	When you ask for certain information, your boss explains how he is not supposed to share that information with you. Says that he/she will not answer your query? Says that particular information can be shared only with a particular project team?

### 3.5 Data Analysis

The first step in qualitative data analysis is to go through the data to break down into pieces to examine closely, compare for relations, similarities, and dissimilarities. Different parts of the data are marked with appropriate labels or ‘codes’ to identify them for further analysis (Khandkar, 2009). Transcribed data were analysed using open coding and axial coding. At the first level of coding, we looked for distinct concepts and categories in the data gathered through interview, which formed the basic structure of analysis. In other words, we broke down the data into first level concepts, or master headings, and second-level categories, or subheadings (Strauss & Corbin, 1990). In open coding, we focused primarily on the text to define concepts and categories. In axial coding, we used our concepts and categories while re-reading the text to confirm that our concepts and categories accurately represented interview responses and to explore how our concepts and categories are related (Thomas, 2006).

Does the divergence exist? As a starting point, it is helpful to see if there is a diverse pattern of behaviours emerged through data analysis, the one which deviates from the predicted relationship. There emerged two streams of observation; one who felt envied have reported that their bosses engage in evasive hiding and the other stream of participants who did not believe their bosses envy them. Themes and sub-themes that emerged after analysis are shown in Table 3.

Tab. 3 – Themes emerged in data analysis. Source: own research

Theme	Sub Theme	Supporting evidence
Leader’s Envy	Feelings of envy	“He doesn’t highlight or acknowledge my achievements and doesn’t bring them into higher management’s notice.” “I do feel that my accomplishments annoy him, but he doesn’t really express it in front of me; rather, he tries to give this impression to others that it is not something very major.” “He doubts that if my colleagues or I can produce more research papers than him, it somehow discredits him or reduces his value as the head of our department (HOD).” “As our department is affiliated with Pakistan Education Commission (PEC) and Higher Education Commission (HEC), they both have the requirement to have a

		<p>HOD who preferably has a doctorate and no. of research papers. Since our HOD doesn't have a Ph.D., he seriously feels that some of my colleagues or I who are Ph.D. doctors can take his place.”</p> <p>“Yes, I will agree that my accomplishments annoy him to some extent because it is a natural phenomenon that most of the time one will find out the professional jealousy if other is doing well in his assigned tasks.”</p> <p>“Yes, because I am in academia and education counts a lot in academia. Alhamdulillah, I am more educated, and due to this reason, he considers me as a threat to his future career growth.”</p>
	Actions in response	<p>“Many of my competent colleagues and I have noticed that he consciously tries to prolong the processes in which his consent is needed, will unnecessarily ask others to revise their work just to waste time so that others will get demotivated.”</p> <p>“He tries to undermine others effort and overlook the hard work of others; it results in his skeptical and poor performance evaluation of his subordinates.”</p> <p>“He assigns me a task, which is not exactly my responsibility. He neglects the fact that the purpose of my job is to teach or to do research, for instance, not to make a list of equipment in faculty rooms.”</p> <p>“The reason behind this fact is that I found many instances in my career when he portrayed the twisted version of my behavior and sometimes performances towards the higher management. However, many times, his hypocritical behavior is evidence of professional jealousy.”</p> <p>“In my view, every boss does that; they do not let their subordinates grow.”</p>
Knowledge Hiding	Evasive Hiding	<p>“If you are asking him about some information regarding different processes he won't say that he doesn't know rather will give a piece of very vague, concise and insufficient information on that.”</p> <p>“The one very famous word which we often use for this type of things ‘Terkhana’ (stalling) this is exactly what he mostly does.”</p> <p>“He will tell only part of the things you have asked him.”</p> <p>“My boss does not provide the needed data on time.”</p> <p>“No, he wouldn't say that he will not answer my query; rather, he will pretend that he is busy.”</p> <p>“He doesn't pretend that he is not aware of what I am asking, but he intentionally ignores and pretends as he is very busy, so don't have enough time to help me.”</p>
	Playing Dumb	<p>“When he is asked to help me/ guide me about my official assignments, most of the time, he says that he does not know that issue.”</p>

## 4 EMPIRICAL RESULTS

### 4.1 Leader's envy

Respondent told us that he believes his immediate boss, who is HOD of the department where the respondent works as an assistant professor, has a strong feeling of envy towards him and few of his competent colleagues.

*“He doesn't highlight or acknowledge my achievements and doesn't bring them into higher management's notice.”*

In academic institutions, promotion is based on research papers one produces. Respondents believe that this feeling of envy of their bosses toward them is because of the fact they can produce more research papers than their boss does.

*“He doubts that if my colleagues or I am able to produce more research papers than him, it somehow discredits him or reduces his value as HOD.”*

*“As our department is affiliated with PEC and HEC, they both have the requirement to have a HOD who preferably has a doctorate and the required number of published research papers. Since our HOD doesn't have a Ph.D., he seriously feels that I or some of my colleagues who are Ph.D. doctors can take his place.”*



People indulge in envious feelings when they compare their social standing with others (Elfenbein, Eisenkraft & Ding, 2009). Leaders may compare their standing in their organization with their followers who can be potential competitors for their hierarchical position and social standing (D'Arms & Kerr, 2008).

*“Yes, I will agree that my accomplishments annoy him to some extent because it is a natural phenomenon that most of the time one will find out the professional jealousy if other is doing well in his assigned tasks.”*

*“Yes, because I am in academia and education counts a lot in academia. Alhamdulillah, I am more educated, and due to this reason, he considers me as a threat to his future career growth.”*

In the present study, respondents' research profile and level of qualification as compared to their bosses may have ignited the feeling of envy towards them as this is the one possible reason due to which boss might see respondent as a competitor.

## **4.2 Responsive Actions**

Leader's envy can invoke a variety of actions towards the envied. They can range from bullying, public humiliation of envied to harming them by putting hurdles in their ways to achieve their goals and accomplishments. Most of the respondents believe that their bosses consciously try to delay the processes where their assistance is needed so that respondents get demotivated.

*“Many of my competent colleagues and I have noticed that he consciously tries to prolong the processes in which his consent is needed, will unnecessarily ask others to revise their work just to waste time so that others will get demotivated.”*

The other negative behavioural responses to the feeling envy leaders have towards the follower they envy includes undermining their accomplishments try that their accomplishments get overlooked by top management.

*“He tries to undermine others effort and overlook the hard work of others; it results in his sceptical and poor performance evaluation of his subordinates.”*

*“The reason behind this fact is that I found many instances in my career when he portrayed the twisted version of my behaviour and sometimes performances towards the higher management. However, many times, his hypocritical behaviour is evidence of professional jealousy.”*

Some of the respondents believe that it is normal in organizations that bosses their followers to not grow in their career.

*“In my view, every boss does that; they do not let their subordinates grow in their career.”*

## **4.3 Knowledge Hiding**

In an effort to undermine the efforts of subordinates, leader's envy makes leaders to hide information from their subordinates (Tai, Narayanan & McAllister, 2012). Many of the respondents believe that their bosses intentionally hide the requested information by just telling the part of it or by giving very concise information, which would not be sufficient for the matter in hand.

*“If you are asking him about some information regarding different processes he won't say that he doesn't know rather will give a piece of very vague, concise and insufficient information on that.”*

*“He doesn't pretend that he is not aware of what I am asking, but he intentionally ignores and pretends as he is very busy, so don't have enough time to help me.”*

Respondents believe that their bosses consciously try to stall it when they are asked of certain information regarding the publication processes and other information that would be helpful for respondents to accomplish something.

*“The one very famous word which we often use for this type of behaviour ‘Terkhana’ (stalling) this is exactly what he (boss) mostly does.”*

One of the respondents told us his boss never says a direct no when he is asked of any information, as he thinks that saying a direct no because it might negatively affect his reputation.

Playing dumb involves deception and is socially acceptable (Connelly et al., 2012). Interviews show that sometimes leaders decide to play dumb in response to some query.

*“When he is asked to help me/ guide me about my official assignments, most of the time, he says that he does not know that issue.”*

## **5 DISCUSSION AND CONCLUSIONS**

### **5.1 Theoretical contributions**

This study aimed to understand that leaders, just like other humans, are subjected to negative feelings of envy as well, and when they do, in what way they respond to it. What kind of negative behaviours do they indulge? One of which is knowledge hiding. According to traditional approaches of leadership, leaders are supposed to mentor, support, and motivate their employees towards the achievement of goals (Vroom & Jago, 2007). Most leaders do their utmost to maximize their subordinates’ performance to achieve organizational goals (McCull-Kennedy & Anderson, 2002). This picture is at odds with leaders who resent the advantages of their subordinates and indulge in negative behaviours to undermine their performance even at the cost of organizational performance.

In contrast to the vast literature existed on different forms of leadership behaviours and their heroic side; we examined the human side of leaders which can make them envious of their subordinates and engage them in negative behaviours towards them. Leaders are people with their desires and goals. According to this perspective, leaders desire to achieve more than others (Stein, 1997) to secure their hierarchal position and maintain their social standing.

When leaders see their subordinates as a threat to their hierarchal position and social standing, they might obstruct the development and career advancement of followers that are perceived as competitors (Scandura, 1998). The potential negative effect of this social comparison can be seen on followers’ career advancement and achievements when such leaders hide the information necessary for subordinates to accomplish their tasks. It is seen in the present study that such leaders intentionally demotivate their subordinates and hide knowledge from them when they need it. There can be other consequences of leader’s envy too, as it is evident from the responses of the interviewees that their bosses sometimes assign irrelevant tasks to them to overburden them and belittle their efforts in front of top management. However, the purpose of this paper was to inquire whether the leader’s envy has a link to knowledge hiding. Evidence suggests that in this regard, evasive hiding is more prevalent as compared to the other forms of knowledge hidings. It was also seen that leaders might play dumb to hide knowledge. Such knowledge hiding can be detrimental for both organizational performance and employee’s performance. It has the potential of ruining the healthy, productive organizational climate.

## 5.2 Practical Implications

It is important for management to understand envy in the context of leader-follower relationships because the consequences of envy can be far-reaching and detrimental for the well-being of employees and organization. The negative behaviour emerged due to envy, such as knowledge hiding from subordinates can have a negative influence on performance outcomes of employees, which consequently will influence overall organizational performance.

It is also important for organizations to encourage their leaders and managers to improve their capabilities while accepting their personal limitations. Organizations need to change their leader's mind-sets and approach to leadership such that they view their roles less in terms of being the major source of competence in the group and more in terms of how they can draw out, use, and advance the competence of others. In addition, organizations should foster a knowledge sharing culture.

## 5.3 Limitations and future research directions

This study is not without limitations. First, we focused on universities, and the phenomena can have a different basis in business organizations. Moreover, we did not provide insights on contextual and interpersonal antecedents of leader's envy; there can be many factors other than the social comparison with competent subordinates, which can evoke the feelings of envy. Those factors are needed to be studied in order to fully understand the circumstances, which can result in the leader's envy.

## References

- Alicke, M., & Zell, E. (2008). Social Comparison and Envy. In R. Smith (Ed.), *Envy: Theory and Research*. Oxford: Oxford University. doi: 10.1093/acprof:oso/9780195327953.003.0005
- Babcock-Roberson, M. E., & Strickland, O. J. (2010). The Relationship between Charismatic Leadership, Work Engagement, and Organizational Citizenship Behaviors. *The Journal of Psychology*, 144(3), 313-326. doi: 10.1080/00223981003648336
- Bartol, K. M., & Srivastava, A. (2002). Encouraging Knowledge Sharing: The Role of Organizational Reward Systems. *Journal of Leadership & Organizational Studies*, 9(1), 64-76. doi: 10.1177/107179190200900105
- Bedeian, A. G. (1995). Workplace envy. *Organizational Dynamics*, 23(4), 49-56. doi: 10.1016/0090-2616(95)90016-0
- Brooke, S. (2006). Leadership and Job Satisfaction. *Academic Leadership: The Online Journal*, 4(1), Article 6. Retrieved from <https://scholars.fhsu.edu/alj/vol4/iss1/6>
- Collinson, D. (2005). Dialectics of leadership. *Human Relations*, 58(11), 1419-1442. doi: 10.1177/0018726705060902
- Connelly, C. E., Zweig, D., Webster, J., & Trougakos, J. P. (2012). Knowledge Hiding in Organizations. *Journal of Organizational Behavior*, 33(1), 64-88. doi: 10.1002/job.737
- Cooper, C., & Payne, R. (1989). *Causes, coping and consequences of stress at work*. Chichester, UK: Wiley.
- Creswell, J. W. (1998). *Qualitative inquiry and research design: Choosing among five traditions*. Thousand Oaks: SAGE.

- D'Arms, J., & Kerr, A. D. (2008). Envy in the philosophical tradition. In R. Smith (Ed.), *Envy: Theory and Research*. Oxford: Oxford University. doi: 10.1093/acprof:oso/9780195327953.003.0003
- Dijkstra, P. G. (2011). *Social Psychology Foundations of Clinical Psychology*. New York: Guilford Press.
- Eisenhardt, M. (1989). Agency Theory: An Assessment and Review. *Academy of Management Review*, 14(1), 57-74. doi: 10.5465/amr.1989.4279003
- Elfenbein, H. A., Eisenkraft, N., & Ding, W. W. (2009). Do We Know Who Values Us? Dyadic Meta-Accuracy in the Perception of Professional Relationships. *Psychological Science*, 20(9), 1081-1083. doi: 10.1111/j.1467-9280.2009.02396.x
- Hislop, D. (2003). Linking human resource management and knowledge management via commitment: A review and research agenda. *Employee Relations*, 25(2), 182-202. doi: 10.1108/01425450310456479
- Janz, B. D., & Prasarnphanich, P. (2003). Understanding the Antecedents of Effective Knowledge Management: The Importance of a Knowledge-Centered Culture. *Decision Sciences*, 34(2), 351-384. doi: 10.1111/1540-5915.02328
- Jung, D. I., & Sosik, J. J. (2002). Transformational leadership in work groups: The Role of Empowerment, Cohesiveness, and Collective-Efficacy on Perceived Group Performance. *Small Group Research*, 33(3), 313-336. doi: 10.1177/10496402033003002
- Husted, K., Michailova, S., Minbaeva, D. B., & Pedersen, T. (2012). Knowledge-sharing hostility and governance mechanisms: An empirical test. *Journal of Knowledge Management*, 16(5), 754-773. doi: 10.1108/13673271211262790
- Keskes, I. (2014). Relationship between leadership styles and dimensions of employee organizational commitment: A critical review and discussion of future directions. *Intangible Capital*, 10(1), 26-51. doi: 10.3926/ic.476
- Kets de Vries, M. F. (1994). The leadership mystique. *Academy of Management Perspective*, 8(3), 73-89. doi: 10.5465/AME.1994.9503101181
- Khandkar, S. H. (2009). *Open Coding*. Calgary: University of Calgary. Retrieved from <http://pages.cpsc.ucalgary.ca/~saul/wiki/uploads/CPSC681/open-coding.pdf>
- Leheta, D., Dimotakis, N., & Schatten, J. (2016). The view over one's shoulder: The causes and consequences of leader's envy of followers. *The Leadership Quarterly*, 28(3), 451-468. doi: 10.1016/j.leaqua.2016.12.002
- McCull-Kennedy, J. R., & Anderson, R. D. (2002). Impact of leadership style and emotions on subordinate performance. *The Leadership Quarterly*, 13(5), 545-559. doi: 10.1016/S1048-9843(02)00143-1
- McGrath, D. L. (2011). Workplace Envy: The Methodological Challenges of Capturing a Denied and Concealed Emotion. *International Journal of Interdisciplinary Social Sciences*, 6(1), 81-89. doi: 10.18848/1833-1882/CGP/v06i01/51995
- Menon, T., & Thompson, L. (2010). Envy at Work. *Harvard Business Review*, 88(4), 74-79. Retrieved from [https://www.researchgate.net/publication/43199516\\_Envy\\_at\\_work](https://www.researchgate.net/publication/43199516_Envy_at_work)
- Merriam, S. B. (1998). *Qualitative research and case study applications in education*. San Francisco: Jossey-Bass.

- Newcombe, M. J., & Ashkanasy, N. M. (2002). The role of affect and affective congruence in perceptions of leaders: an experimental study. *The Leadership Quarterly*, 13(5), 601-614. doi: 10.1016/S1048-9843(02)00146-7
- Ozkoc, A. G., & Caliskan, N. (2015). The Impact of Organizational Envy on Organizational Climate Created among Employees: An Application in Accommodation Enterprises. *International Journal of Business and Management*, 10(1), 40-49. doi: 10.5539/ijbm.v10n1p40
- Parrott, W. G., & Smith, R. H. (1993). Distinguishing the experiences of envy and jealousy. *Journal of Personality and Social Psychology*, 64(6), 906-920. doi: 10.1037//0022-3514.64.6.906
- Patton, M. Q. (2002). *Purposeful Sampling*. Thousand Oaks: SAGE.
- Peng, H. (2013). Why and when do people hide knowledge? *Journal of Knowledge Management*, 17(3), 398-415. doi: 10.1108/JKM-12-2012-0380
- Plato (360 BCE/2007). *Philebus*.
- Rossmann, G. B., & Rallis, S. F. (2003). *Learning in the Field: An Introduction to Qualitative Research*. Thousand Oaks: SAGE.
- Scandura, T. A. (1998). Dysfunctional mentoring relationships and outcomes. *Journal of Management*, 24(3), 449-467. doi: 10.1177/014920639802400307
- Schoeck, H. (1969). *Envy: A Theory of Social Behaviour*. Indianapolis: Liberty Fund.
- Smith, R. H. (2008). *Envy: Theory and research*. Oxford: Oxford University.
- Smith, R. H., & Kim, S. H. (2007). Comprehending envy. *Psychological Bulletin*, 133(1), 46-64. doi: 10.1037/0033-2909.133.1.46
- Stein, M. (1997). Envy and leadership. *European Journal of Work and Organizational Psychology*, 6(4), 453-465. doi: 10.1080/135943297399033
- Strauss, A., & Corbin, J. (1990). *Basics of Qualitative Research: Grounded Theory Procedures and Techniques*. New York: SAGE.
- Suls, J., & Wheeler, L. (2013). *Handbook of Social Comparison: Theory and Research*. New York: Springer.
- Tai, K., Narayanan, J., & McAllister, D. J. (2012). Envy As Pain: Rethinking the Nature of Envy and Its Implications for Employees and Organizations. *Academy of Management Review*, 37(1), 107-129. doi: 10.5465/amr.2009.0484
- Thomas, D. R. (2006). A general inductive approach for analyzing qualitative evaluation data. *American Journal of Evaluation*, 27(2), 237-246. doi: 10.1177/1098214005283748
- Thompson, G., Glasø, L., & Martinsen, Ø. (2015). Antecedents and Consequences of Envy. *The Journal of Social Psychology*, 156(2), 139-153. doi: 10.1080/00224545.2015.1047439
- Van de Ven, N., Zeelenberg, M., & Pieters, R. (2009). Leveling up and down: The experiences of benign and malicious envy. *Emotion*, 9(3), 419-429. doi: 10.1037/a0015669
- Vroom, V. H., & Jago, A. G. (2007). The role of the situation in leadership. *American Psychologist*, 62(1), 17-24. doi: 10.1037/0003-066X.62.1.17

Wasko, M. M. (2005). Why should I share? Examining social capital and knowledge contribution in electronic networks of practice. *MIS Quarterly*, 29(1), 35-58. Retrieved from <https://search.proquest.com/docview/218122431?accountid=15518>

### **Contact information**

#### **Moazzam Ali**

University of Okara, Faculty of Management & Social Sciences  
2 KM Multan Road Renala Khurd By Pass, Okara, Pakistan  
E-mail: moazzamali@uo.edu.pk  
ORCID: 0000-0003-3305-4438

#### **Muhammad Usman**

COMSATS University Islamabad  
Lahore Campus, 1.5 KM Defence Road, Off Raiwind Road, Lahore, Pakistan  
E-mail: hmusman10@yahoo.com  
ORCID: 0000-0002-7818-4546

#### **Nhat Tan Pham**

Tomas Bata University in Zlín, Faculty of Management and Economics  
Mostní 5139, 76001, Zlín, Czech Republic  
E-mail: nhatpham1729@gmail.com  
ORCID: 0000-0001-9927-2257

doi: 10.7441/dokbat.2019.002

# USING KANO METHOD TO MEASURE EMPLOYEE SATISFACTION

*Shavkat Alimov*

## **Abstract**

Employee satisfaction is an important factor for all managers of organization. Most managers undertakes job design without considering various attributes that affects employee satisfaction at workplace. Therefore, it is vital for any organization to know the job attributes that are likely to impact on employee satisfaction. Based on these facts, the researcher undertook this study with an objective analysing how Kano method can be used in measuring employee satisfaction. An extensive literature review on the subject was carried out. The outcome of this study indicated that indeed Kano method can be used in measuring employee satisfaction. The Kano method can be complemented with the Importance Grid Analysis method. The aim of this paper is to analyse literature review of Kano method and its relation to measure employee satisfaction.

*Keywords: Kano method, employee satisfaction, workforce, literature review, Grid Analysis*

## **1 INTRODUCTION**

The global competition and the increasing rise in knowledge economy has put emphasis on the importance of Employee satisfaction in the business competition. The willingness to do a good job is chiefly influenced by employee satisfaction. It is imperative to note that satisfied employees have a high motivation to do work, work in an efficient and effective manner (Eskildsen & Dahlgaard, 2000). Similarly, satisfied employees are more committed to quality and general continuous improvement. Therefore, satisfaction of employees directly influences the quality of a process. Consequently, process quality influences customer satisfaction and the cost quality. Gremler, Bitner and Evans (1994) argues that employees are equal to the company's "internal customers" who needs to be continually satisfied. The satisfaction of employees has always been the key point for researchers. According to Chi and Gursoy (2009), employee satisfaction is one of the major predictor of turnover. Gruban (2010) assert that for successful operation, companies need satisfied employees since employee satisfaction directly translates to the employee commitment to work, honest and consciousness of an employee which in turn reflects on the employee performance. Overall, the significance of employee satisfaction cannot be over emphasized as it directly affects the performance of a firm. This paper will measure employee satisfaction using Kano method because this method prioritizes features which are likely to satisfy employees.

## **2 LITERATURE REVIEW**

The current economic situation has forced most enterprises in almost all industries to take each opportunity available to secure their market. The executive of companies in most instances cannot influence the circumstances outside their environment but they can influence situations within the company. Human resource is one of the factors that is important for a company. The questions on how satisfied are the employees with their working conditions, the type of emotional climate one has in the group and the leadership styles are all vital factors. Wright, Dunford and Snell (2001) and Fulmer, Gerhart and Scott (2003) explain that there is a strong association between employee satisfaction and company productivity, customer satisfaction, leadership and the financial outcome of a company. Therefore, this paper will delve on the assessment of employee satisfaction using Kano method.

## 2.1 Employee satisfaction

According to Cranny, Smith and Stone (1992), employee satisfaction is defined as the combination of affective reactions to the differential perceptions of what they want to receive compared with what they actually receive. The success of an organization and employee satisfaction are directly associated to one another. Presently, the organization managers are faced with the challenge of motivating their work force. The engagement of employee has become a major pillar of success for most companies globally. Employee engagement not only have a huge potential of affecting employee productivity, retention and loyalty but also it is a vital aspect to customer reputation, customer satisfaction and the general value to stakeholders. Each organization aspires to develop an optimum shareholder value which can only be achieved when maximum business performances are achieved which can only be attained when there employee satisfaction. The performance of employees plays a significant part in any company.

## 2.2 A review of Kano method

The Kano model was devised by Dr. Noriaki Kano in the year 1984. The model illustrates the relationship between the performance attribute of a product and its overall impact on customer satisfaction (Kano et al., 1984). In most cases, Kano model is considered as a model of customer satisfaction and a quality model depending on the purpose (Berger, 1993). A customer satisfaction is a process that is on-going and as new demands arise. Moreover, the Kano model employs a questionnaire which consists of a functional and a dysfunctional questions that are useful in retrieving feedback from customers and the feedback is majorly used in the development of a product. The Kano model divides the attributes of products into three major categories as: The threshold, the performance and the excitement (Beng Ang, 1993) as shown below.

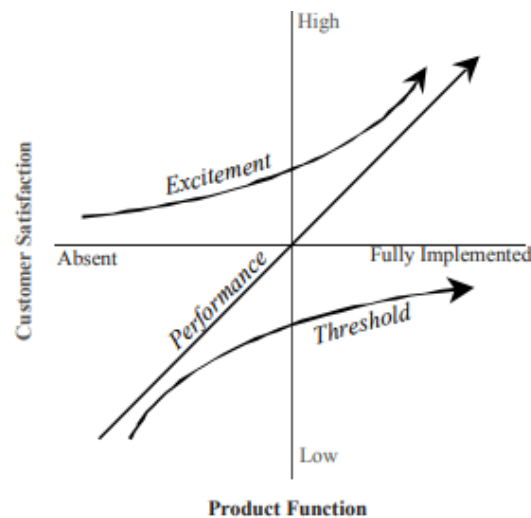

Fig. 1 – Performance and excitement. Source: Beng Ang (1993)

A product that is competitive must be able to meet the basic attributes and be able to optimize the performance attribute (Hartono & Chuan, 2011). In addition, it must have as many “excitement” attributes as possible but that the market can be able to bear.

**Threshold attributes:** These are the expected attributes or the “must” be attributes of a product and it does not offer an opportunity for product differentiation. However, lack of these attributes leads to an extreme customer dissatisfaction. A good example is car brakes (Jacobs, 1999).

**Performance attributes:** These are the functional attributes of a product that will increase customer satisfaction. On the other hand, absence of performance attribute will often lead to



customer dissatisfaction. The cost at which a customer is willing to pay for a product is in most cases tied to the performance of a product. An example is that customer will be willing to pay more for a vehicle that will offer them a better fuelling economy.

**Excitement attributes:** These refers to attributes that are unspoken or unexpected attributes by the customer but can lead to a higher level of customer satisfaction. However, absences of these attributes do not lead to customer dissatisfaction. In a competitive environment in which products from different manufacturers provide similar performances, offering excitement attributes can lead to a competitive advantage.

### 3 METHODOLOGY

An extensive literature review on Kano method and its application to employee satisfaction was conducted. More than 20 journals were reviewed but the researcher narrowed down to 15 journals that delved on the Kano methods and its applicability in measuring employee satisfaction. All the journals were chosen from Scopus and Web of Science Database. An importance grid analysis as recommended by Anne and Grønholdt (2001) was adopted for the present study. The importance grid analysis measures attributes such as the explicit important attributes obtainable through direct rating, against the implicit important attributes that is obtainable by regressing attribute performance against the overall measure of employee satisfaction (Mikulić & Prebežac, 2011). A two-dimension grid having four quadrants can then be constructed bearing the explicit important attributes and the implicit important attributes on the axes. The location of each and every attributes inside the grid reflects the different Kano factors. Low et al. (2015) applied the same method in determining employee satisfaction in Singapore and the results are as follows.

### 4 RESULTS

The outcome from the reviewed literature shows that Kano method can be used in measuring employee satisfaction. Employee are the “internal” customer of any organization and hence Kano method can be applied in measuring their level of satisfaction. A research done by Low et al. (2015) using Kano method to measure employee satisfaction yielded varied results. The researchers constructed the Kano satisfaction coefficient graphs as recommended by Matzler, Fuchs & Schubert (2004). From their outcome, employee salary appeared to be a one-dimensional factor that yielded the highest employee satisfaction if fully fulfilled and the highest employee dissatisfaction if not fulfilled. The courses was found to be an indifferent factor that does not affect employee satisfaction whether it is met or not. Factors such as manpower, flexibility, working hours were found to be attractive features as there is a very high satisfaction when met and a low satisfaction if not achieved.

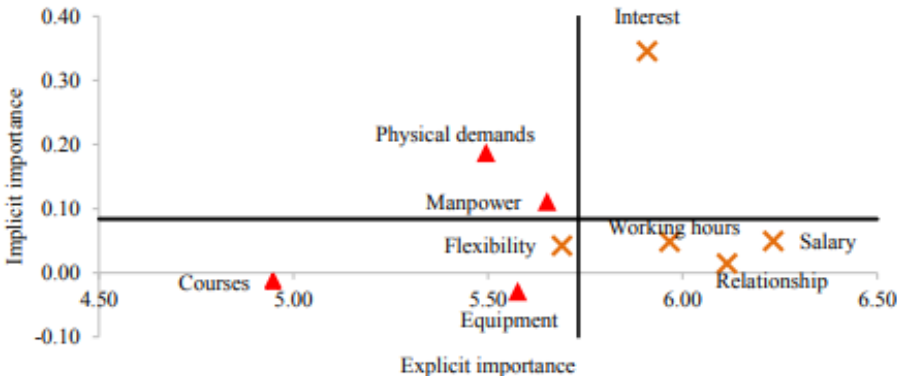

Fig. 2 – Kano satisfaction coefficients. Source: Low et al. (2015)

## 5 CONCLUSION

In summary, employers can use Kano method in measuring employee satisfaction at their places of work. The outcome from the current study has shown that salaries, manpower, flexibility and working hours are the important factors that affects employee satisfaction. Therefore, the implication of this study is that organization managers and human resource managers should take into consideration these attributes while designing jobs as it affect employee satisfaction which in turn impacts on their performances and the overall organization performance.

### References

- Anne, M., & Grønholdt, L. (2001). Using employee satisfaction measurement to improve people management: An adaptation of Kano's quality types. *Total Quality Management*, 12(7-8), 949-957. doi: 10.1080/09544120100000020
- Beng Ang, K., Tee Goh, C., & Chye Koh, H. (1993). Research notes, the impact of age on the job satisfaction of accountants. *Personnel Review*, 22(1), 31-39. doi: 10.1108/00483489310025184
- Berger, C. (1993). Kano's methods for understanding customer-defined quality. *Center for Quality Management Journal*, 2(4), 3-36.
- Chi, C. G., & Gursoy, D. (2009). Employee satisfaction, customer satisfaction, and financial performance: An empirical examination. *International Journal of Hospitality Management*, 28(2), 245-253. doi: 10.1016/j.ijhm.2008.08.003
- Cranny, C. J., Smith, P. C., & Stone, E. (1992). Job satisfaction: How people feel about their jobs. *Personnel Psychology: The Study of People at Work*, 46(2), 365-472. doi: 10.1111/j.1744-6570.1993.tb00879.x
- Eskildsen, J. K., & Dahlgaard, J. J. (2000). A causal model for employee satisfaction. *Total Quality Management*, 11(8), 1081-1094. doi: 10.1080/095441200440340
- Fulmer, I. S., Gerhart, B., & Scott, K. S. (2003). Are the 100 best better? An empirical investigation of the relationship between being a "great place to work" and firm performance. *Personnel Psychology*, 56(4), 965-993. doi: 10.1111/j.1744-6570.2003.tb00246.x
- Gremler, D. D., Jo Bitner, M., & Evans, K. R. (1994). The internal service encounter. *International Journal of Service Industry Management*, 5(2), 34-56. doi: 10.1108/09564239410057672
- Gruban, B. (2010). MBO: Management by Objectives or Management by Blaming Others? Retrieved from <http://www.dialogos.si/slo/objave/clanki/ciljno-vodenje/>
- Hartono, M., & Chuan, T. K. (2011). *A proposed integrative framework of Kansei Engineering and Kano model applied to services*. Paper presented at The 2nd International Research Symposium in Service Management, Yogyakarta, Indonesia. Yogyakarta: Universitas Pembangunan Nasional. Retrieved from <http://repository.ubaya.ac.id/27984/>
- Jacobs, R. (1999). Evaluating Satisfaction with Media Products and Services: An Attribute Based Approach. *European media management review*.
- Kano, N., Seraku, N., Takahashi, F., & Tsuji, S. (1984). Attractive Quality and Must-Be Quality. *The Journal of the Japanese Society for Quality Control*, 14(2), 147-156. doi: 10.20684/quality.14.2\_147

- Low, S., Tan, K. C., Peacock, B., Loh, S. K., & Ping, C. Y. (2015). A proposed Kano-inspired framework applied to job satisfaction for mature Singaporeans. *Procedia Manufacturing*, 3, 4892-4899. doi: 10.1016/j.promfg.2015.07.619
- Matzler, K., Fuchs, M., & Schubert, A. (2004). Employee satisfaction: does Kano's model apply? *Total Quality Management & Business Excellence*, 15(9-10), 1179-1198. doi: 10.1080/1478336042000255569
- Mikulić, J., & Prebežac, D. (2011). Rethinking the importance grid as a research tool for quality managers. *Total Quality Management & Business Excellence*, 22(9), 993-1006. doi: 10.1080/14783363.2011.593857
- Wright, P. M., Dunford, B. B., & Snell, S. A. (2001). Human resources and the resource based view of the firm. *Journal of Management*, 27(6), 701-721. doi: 10.1177/014920630102700607

### **Contact information**

#### **Shavkat Alimov**

Tomas Bata University in Zlín, Faculty of Management and Economics  
Mostní 5139, 76001, Zlín, Czech Republic  
E-mail: alimov@utb.cz  
ORCID: 0000-0001-5118-1663

doi: 10.7441/dokbat.2019.003

# **SUPPLIER-RELATIONSHIP MANAGEMENT, COMPETITIVE ADVANTAGE AND FIRM PERFORMANCE IN THE SERVICE INDUSTRY: A CONCEPTUAL STUDY**

*Christina Appiah-Nimo, Daniel Ofori, Michael Adu Kwarteng,  
Miloslava Chovancová*

## **Abstract**

This conceptual paper sought to study the relationship among supplier relationship management, competitive advantage and firm performance. The study reviewed literature related to these three variables. Several databases concerning the fields were used to acquire relevant literature on the topic. Methods to conduct future research were also highlighted. The literature reviewed discovered supplier relationship management had a relationship with firm performance although not quite significant but had a stronger influence on competitive advantage. However, competitive advantage appeared most influential as it had a direct relationship with firm performance. Conclusions drawn from the literature are that hotels can improve their performance and survival by having a competitive edge over their competitors. And to achieve this competitive advantage, hotels need to have a collaborative relationship with their suppliers. This conceptual paper ends with recommendations for future research to test whether these variables have any empirical relationships, especially in the hospitality sector.

*Keywords: Supplier relationship management, competitive advantage, firm performance, hotels*

## **1 INTRODUCTION**

Today's competitive industries have intensified the challenges associated with getting a product and service to the right place at the right time; without losing out on customers' value and also at reduced costs. Firms have established and integrated effective supply chains to make them more competitive. However, there cannot be an effective Supply Chain Management (SCM) without a conscious relationship with the suppliers. Literature review conducted by Terpend, et al. (2008), found that published papers on buyer-supplier relationships had more than tripled over 20 years. Their study concluded that the focus on the supply side had changed from being a 'buyer practices' to 'buyer-supplier relationship practices'. Moreover, emphasis by Porter (1980) on his five forces model of competitive advantage depicts the importance of building good supplier relationships to achieve competitive advantage. This power of the supplier according to Porter, is the force that explains how easily suppliers can push up the cost of inputs. Thus, the power is affected by the number of suppliers of key inputs of a good or service, how unique these inputs are, and even how much it would cost a company to switch from one supplier to a different one. Additionally, the fewer the number of suppliers, and the more a company depends upon a supplier, the more power a supplier holds to drive up input costs and push for advantage in trade.

However, when a business has many suppliers or the cost of switching between rival suppliers are low, that business can keep input costs at a minimum to increase profit (Porter, 1980). Subsequently, buyers have moved towards long-term, collaborative relationships with fewer suppliers (Cousins et al., 2008). Aside from the growing complexity of technologies, global competition and the need for competitive advantage requires a more collaborative relationship between buyers and suppliers notwithstanding low or high volume suppliers. Hence, it is

important to involve the supplier at the early stages of need. Supplier Relationship Management (SRM) may be referred to as the practice of planning, organizing, developing, implementing and monitoring of company relationships with current and potential suppliers (Wagner, 2011).

Extant literature proves the role supplier relationship management play in enhancing firm competitiveness and performance is very significant and crucial and therefore needs more research (Kim, 2013; Prajogo et al., 2012; Wook Kim, 2006; Chen, Paulraj & Lado, 2004; Wisner, 2003; Cousins & Spekman, 2003; Carter & Narasimhan, 1996; Ellram & Carr, 1994). A notable consequence of this enhanced significance of supplier management is that purchasing activities are rarely managed by a single department. This perspective simply means an increased integration and coordination of purchasing and supply management with other departments, including; strategy, marketing, product design, and supply chain management. Hence, Mogre, Lindgreen and Hingley (2017) argued that purchasing in the twenty-first century is evolving into a cross-functional business process.

The service industry has a unique supply chain, in that; it procures both tangible and intangible goods to achieve their core service in business, thus, satisfying their consumers. For instance, when a hotel provides its core service of accommodation, other supporting services come along with such delivery. In addition, most of these support services are provided by suppliers and some by the service provider itself. Generally, customers perceive all services they receive as one and as aiming to provide them the ultimate benefit. Hence, the delivery of a service is not possible without the interplay of many other tangible objects (products) available to both the service provider and the customer. Arguably, a hotel requires furniture and beddings, major appliances, reliable source of water and electricity, fresh foods and many other items to deliver its services to its guests. Practically, guests experience poor services (rude staff, broken beds, unclean sheets, dirty rooms, un-kept wardrobes, poor lightening, no water supply, no hot water supply, electricity power outages, theft, poor or no internet connection, bad meals, broken shower and air-conditions, poor TV channels and noise) by hotels which render them dissatisfied. Issues of poor management are at the top of the list and most of these hotels collapse due to poor patronage. Providing such timely and quality service satisfaction to their guests demands a coordinated and collaborated relationship between hotels and their suppliers. Ultimately, the performance of these hotels highly lies on how well they communicate to get orders delivered or issues sorted by suppliers.

The relationship between supplier management and performance has been empirically examined in different industries including manufacturing (Nimeh, Abdallah & Sweis, 2018; Hong, Zhang & Ding, 2018), automotive (Han, Huang & Macbeth, 2018) and construction (Sindiga, Paul & Mbura, 2019; Salehi et al., 2018). However, empirical research on the service industry is still lacking and almost non-existent. Due to this, even though, the relationship between the variables can be explained in other industries, many justifications of this relationship cannot rigidly be applied to the service industry. This conceptual study, therefore, sought to bridge the existing knowledge gap by examining the relationship among supplier relationship management, competitive advantage and performance in the hospitality sector in a developing economy.

This conceptual paper has been arranged as follows: the next write-up presents an overview of the theoretical foundation and the conceptual framework followed by the formulation of the research hypotheses. Next is a brief report on the research methods associated with the study. This is followed by the presentation of the significance of the study to theory and practice. This paper concludes with future research directions.

## **2 ANALYSIS AND DISCUSSION OF LITERATURE**

### **2.1 Resource-Based View Theory**

The resource-based view theory according to Penrose (1959) is a resource-based (tangible and intangible) perspective for firms to achieve a competitive advantage over other competing firms and also to achieve firm performance. According to Penrose, a firm extends beyond an administrative unit; it is a collection of productive resources, where the choice of different uses of these resources over time is determined. The physical/tangible resources of a firm consist of plant and equipment, land, and natural resources; raw materials; semi-finished goods; waste products and by-products; as well as unsold stocks of finished goods. Additionally, there also exist human resources who possess unskilled and skilled labour including; clerical, administrative, financial, legal, technical, and managerial staff. Penrose further argued that these human resources are not resources in themselves, but rather the services that these resources render forms the basic inputs in the production process.

Thompson (1967) described how the human variable in an organization affected its actions in his book. Hambrick and Mason (1984) later suggested that organizations generally reflect who their top managers are. In addition to these, Finkelstein and Hambrick (1996) also argued how important the human element is in making strategic choice of the firm and its performance. Notably, resources form the basis of firm strategies and are therefore critical to the implementation of those chosen strategies. This study is thus grounded on the Resource-Based View Theory. In the resource-based view theory, strategists can decide on the best form of strategy or competitive position that best exploits the internal resources of the firm (tangible and intangible) and capabilities relative to external opportunities (tangible and intangible).

Arguably, this distinction is the source of uniqueness of each firm. The general purpose of a firm is to organize the use of its resources together with other resources acquired from outside the firm for the production and sale of goods and services at a profit. The supplier thus becomes a very important external resource who can help a firm achieve a competitive edge amongst its rivals and achieve higher firm performance.

### **2.2 Supplier relationship management**

Supplier Relationship Management (SRM) according to Wagner (2011) is the practice of planning, organising, developing, implementing and monitoring of company relationships with current and potential suppliers. Suppliers, here, simply refers to an organization that sells inputs to other receiving firms to complete the business. Both suppliers and buyers can stabilize their relationship through discussion and collaborations to manage resources efficiently and effectively. Additionally, suppliers are the indispensable part of the supply chain due to the contribution they make towards increasing product quality, flexibility, and costs (Handfield & Ragatz, 1999). This is evident in a study by Giannakis, Doran and Chen (2012) who concluded that both parties (supplier and buyer) in the supplier relationship must engage in a long-term relationship and with high commitment levels. To be able to fully exploit the potential of the supply market, a buying firm must establish a good relationship with its suppliers.

### **2.3 Competitive Advantage**

Today's competitive pressures compel business leaders to continually seek new sources of sustainable advantage to survive. For instance; Porter's approach to competitive advantage centres on a firm's ability to be a low-cost producer in its industry, or to be unique in its industry with regards to some aspects that are popularly valued by customers (Porter, 1991). Generally, cost and quality remain the competitive advantage dimensions of every firm (D' Souza &

Williams, 2000). This implies that competitive advantage no longer resides with a company's innate capabilities but with the relationships and linkages that the firm can forge with external organizations (Lewis, 2000). With the new dynamics of these supply chain partnerships, suppliers and customers are no more treated as though they are independent entities managed in isolation (Spekman, Spear & Kamauff, 2002). Like any other supply chain literature, this research also posits that establishing and managing effective relationships at every stage in the supply chain is a prerequisite for firm success. Sources of competitive advantage include the ability to leverage purchasing across the entire enterprise while reaping the benefits of supply chain information management.

## 2.4 Conceptual framework

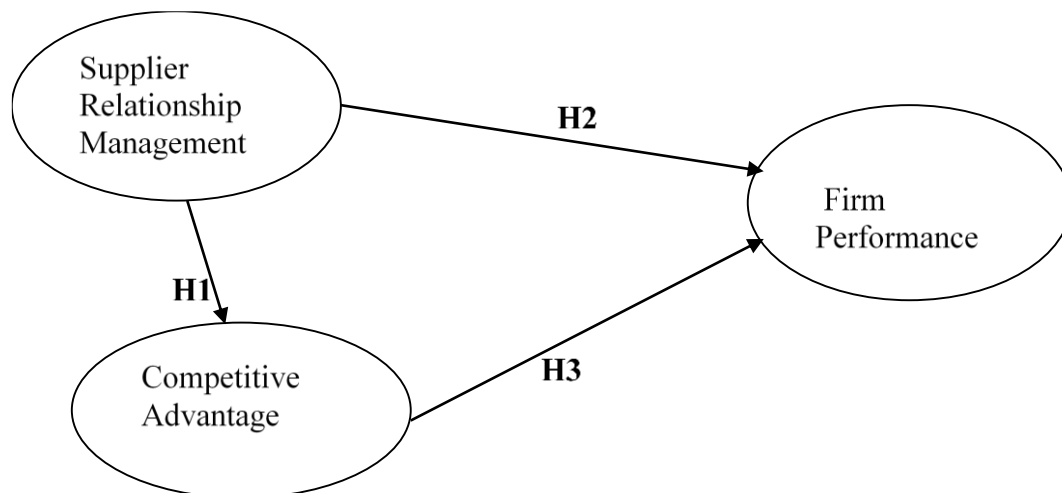

Fig. 1 – Conceptual Framework depicting the hypothesis. Source: own research

## 2.5 Supplier Relationship Management, Competitive Advantage and Firm Performance

Studies on the collaboration between the supplier and the buyer can be reviewed in two ways: by focusing on the collaboration strategy or by using an SRM system to carry out the collaboration strategy. The collaboration strategy can be explored according to the participation phase of new product development and production. In many industries, companies encourage suppliers to be involved in seeking ways to shorten the development time, improve quality, reduce cost, and release new products smoothly. Previous studies have examined the participation time (Handfield & Nichols, 1999), the responsibility level in cooperative development (Petersen, Handfield & Ragatz, 2005), and the type and strength of a contractual relationship (Fliess & Becker, 2006). The most well-known collaboration techniques are JIT purchasing (JITP), which makes the customer's JIT operation possible (Gunasekaran, 1999; Kaynak & Hartley, 2006); vendor managed inventory (VMI), where suppliers take responsibility for a range of contracts and manage the buyer's inventory (Simchi-Levi et al., 2003); and collaborative planning, forecasting, and replenishment (CPFR), which involves integrating the supply chain.

Finally, studies that have investigated SRM systems for collaboration include system-oriented concepts, such as using an integrative case-based supplier selection method (Choy & Lee, 2002), a web-based enterprise collaboration platform, and a collaboration framework from the viewpoint of business strategy (Cox et al., 2004; Moeller, Fassnacht & Klose, 2006). All these studies have found how important SRM is and its influence on firm performance although not directly. Notable amongst them are studies by Yang, Zhang and Xie (2017), Gandhi, Shaikh and Sheorey (2017), Tseng (2014), Al-Abdallah, Abdallah and Hamdan (2014). Collaboration

with suppliers makes firms more competitive and provides firms with a broader urge over competitors. Hotels aptly and easily adapt to the growing demands of customers and easily design new products or services to suit customers' needs. Their ability to provide quality products and services promptly to attract more customers and increases their overall performance highly depends on suppliers. Meaning, if hotels have a good collaboration and relationship with suppliers, they stand the chance of becoming strong in the industry making them possess enormous competitive advantage over competitors. Therefore, this study hypothesizes that;

*H1: Supplier relationship management/supplier management has a positive and significant relationship with competitive advantage.*

*H2: Supplier relationship management/supplier management has a positive relationship with firm performance.*

## **2.6 Competitive Advantage and Firm Performance**

The empirical literature has been consistent in identifying price/cost, quality, delivery and flexibility as important competitive capabilities (Koufteros, Vonderembse & Jayaram, 2005). Besides, other studies have included time-based competition as an important competitive priority. For example studies by Kessler and Chakrabarti (1996) and Zhang and Dhaliwal (2009), identified time as the next source of competitive advantage. Based on prior literature, Koufteros, Vonderembse and Doll (1997) described a research framework for competitive capabilities and defined the following five dimensions: competitive pricing, premium pricing, value-to-customer quality, dependable delivery, and product innovation. Based on these, the dimensions of the competitive advantage constructs used in this study are price/cost, quality, delivery dependability, product innovation, and time to market.

One of the primary objectives of supply chain management is to create greater levels of customer value and competitive advantage for organizations comprising the supply chain. It can be argued that as firms possess higher levels of advantages in the industry, the customer base increases thereby increasing the market share of the firm. Additionally, the expansion in customer base increases the profitability of the firm, thereby, increasing the financial performance of the firm. Constant relationship with suppliers also enables firms to produce quality goods and meets demand on time. Arguably, this increases business or operating performance of firms.

Therefore, this study hypothesizes that;

*H3: Competitive advantage has a positive and significant relationship with the performance of firms.*

## **3 METHODS FOR COLLECTING AND ANALYZING LITERATURE**

This conceptual paper is solely based on reviews and analysis of research and data from related literature. Several methods were used to collect and analyse the literature.

Literature search was conducted using the google scholar search engine. The individual variables were used, though a limited amount of information was found. Literature on supplier relationship management and firm performance proved promising. Other research databases used included Scopus, Web of Science (WOS), ProQuest and EBSCO. All articles deemed relevant to this conceptual paper were retrieved and reviewed. Additionally, books on the topic for this conceptual paper were searched. The same terms used in the database search was used to find books related to the topic.



### **3.1 Data Collection and Data Sources for Future Research**

This conceptual paper is solely based on a review of relevant related literature on the topic of the relationship among supplier relationship management, competitive advantage and firm performance. Future research will be a quantitative study where data will be collected through the administration of questionnaire using valid instruments that measures the variables. Questions for the survey will adopt a Likert scale. The target population would be hotel managers. Issues of ethics will be considered by allowing participants to read and sign a consent form to participate in the study willingly. Participants will also be made aware that information provided in the survey will be completely confidential and used solely for academic purposes.

## **4 FINDINGS AND CONCLUSIONS**

The rigorous review of related literature led to the findings about the factors that influence firm performance. SRM was found to have a link to firm performance but not directly but proved to have a strong link to the competitive advantage of the firm. However, competitive advantage had a direct influence on firm performance. The findings were consistent with all other industries. It is evident the long list of factors responsible for firm performance in literature and hotels are no exception to these factors but this paper focused on supplier relationship to achieve competitive advantage, which ultimately affects performance. In conclusion, hotels generally operate on referrals by satisfied customers while considering pricing and location of such hotels. Consumers now constantly receive information and opinions on which hotel gives better satisfaction. To gain acceptance, managers and policymakers of these hotels must access all the factors that impact their performance, particularly how to gain competitive advantage over other hotels. Another conclusion that was drawn from this conceptual paper is that although supplier relationship management has an influence on hotels performance, this relationship is not very strong as it is moderated by competitive advantage. Arguably, competitive advantage has more influence on performance.

### **4.1 Theoretical relevance**

This paper discusses the all-important concept of supplier relationship management, competitive advantage and firm performance. It extends the discussion onto one important sector under tourism; hospitality. The paper links the relationships among supplier relationship management, competitive advantage and firm performance. There exists a lot of literature on supplier relationship management and firm performance but none has presented competitive advantage in the discussion. This paper will, therefore, add to literature concerning these variables and providing insights especially in the hospitality sector of Ghana.

### **4.2 Managerial relevance**

The ever-increasingly complex environment that hospitality industries find themselves in Ghana is dealing with challenges that threaten their survival and existence. Effective relationship with suppliers in hotels is therefore believed to be a critical requirement for business success. The study, therefore, emphasizes on determining the relationship among supplier management, competitive advantage and firm performance. The relationships were evaluated through rigorous literature review establishing the relationship between supplier management and competitive advantage, supplier management and firm performance and then competitive advantage and firm performance. Extant literature shows that supplier management is an enabler of competitive advantage and both can have a positive relationship with firm performance. This conceptual paper encourages management of hotels and policymakers to

maintain a balanced relationship and strive to develop and implement collaborative policies that will improve relationships and eventually enhance the performance levels of firms.

### 4.3 Limitation and recommendation for future research

This conceptual paper has its analytic restraints because it relied on data previously collected by other researchers. A second limitation was that all the literature on the topics was not adequately explored due to time constraints. Based on the literature reviewed, it is recommended that further research should be conducted to test whether these variables have any relationships, especially in the hospitality sector.

### References

- Al-Abdallah, G. M., Abdallah, A. B., & Hamdan, K. B. (2014). The impact of supplier relationship management on the competitive performance of manufacturing firms. *International Journal of Business and Management*, 9(2), 192-202. doi: 10.5539/ijbm.v9n2p192
- Carter, J. R., & Narasimhan, R. (1996). Is purchasing really strategic? *International journal of purchasing and materials management*, 32(4), 20-28. doi: 10.1111/j.1745-493X.1996.tb00216.x
- Chen, I. J., Paulraj, A., & Lado, A. A. (2004). Strategic purchasing, supply management, and firm performance. *Journal of operations management*, 22(5), 505-523. doi: 10.1016/j.jom.2004.06.002
- Choy, K. L., & Lee, W. B. (2002). On the development of a case-based supplier management tool for multi-national manufacturers. *Measuring Business Excellence*, 6(1), 15-22. doi: 10.1108/13683040210420501
- Cousins, P. D., & Spekman, R. (2003). Strategic supply and the management of inter-and intra-organisational relationships. *Journal of Purchasing and supply Management*, 9(1), 19-29. doi: 10.1016/S1478-4092(02)00036-5
- Cousins, P., Lamming, R., Lawson, B., & Squire, B. (2008). *Strategic supply management: principles, theories and practice*. London: Pearson Education.
- Cox, A., Watson, G., Lonsdale, C., & Sanderson, J. (2004). Managing appropriately in power regimes: relationship and performance management in 12 supply chain cases. *Supply Chain Management*, 9(5), 357-371. doi: 10.1108/13598540410560748
- D'souza, D. E., & Williams, F. P. (2000). Appropriateness of the stakeholder approach to measuring manufacturing performance. *Journal of Managerial Issues*, 12(2), 227-246. Retrieved from <https://www.jstor.org/stable/40604306>
- Ellram, L. M., & Carr, A. (1994). Strategic purchasing: a history and review of the literature. *International Journal of Purchasing and Materials Management*, 30(1), 9-19. doi: 10.1111/j.1745-493X.1994.tb00185.x
- Finkelstein, S., Hambrick, D., & Cannella, A. A. (1996). *Strategic leadership*. St. Paul: West Educational Publishing.
- Fliess, S., & Becker, U. (2006). Supplier integration: Controlling of co-development processes. *Industrial Marketing Management*, 35(1), 28-44. doi: 10.1016/j.indmarman.2005.07.004

- Gandhi, A. V., Shaikh, A., & Sheorey, P. A. (2017). Impact of supply chain management practices on firm performance: Empirical evidence from a developing country. *International Journal of Retail & Distribution Management*, 45(4), 366-384. doi: 10.1108/IJRDM-06-2015-0076
- Giannakis, M., Doran, D., & Chen, S. (2012). The Chinese paradigm of global supplier relationships: Social control, formal interactions and the mediating role of culture. *Industrial Marketing Management*, 41(5), 831-840. doi: 10.1016/j.indmarman.2012.06.008
- Gunasekaran, A. (1999). Agile manufacturing: a framework for research and development. *International Journal of Production Economics*, 62(1-2), 87-105. doi: 10.1016/S0925-5273(98)00222-9
- Hambrick, D. C., & Mason, P. A. (1984). Upper echelons: The organization as a reflection of its top managers. *Academy of Management Review*, 9(2), 193-206. doi: 10.5465/amr.1984.4277628
- Han, W., Huang, Y., & Macbeth, D. (2018). Performance measurement of cross-culture supply chain partnership: a case study in the Chinese automotive industry. *International Journal of Production Research*, 56(7), 2437-2451. doi: 10.1080/00207543.2017.1377357
- Handfield, R. B., & Nichols, E. L. (1999). *Introduction to Supply Chain Management*. Upper Saddle River: Prentice-Hall.
- Handfield, R. B., Ragatz, G. L., Petersen, K. J., & Monczka, R. M. (1999). Involving suppliers in new product development. *California Management Review*, 42(1), 59-82. doi: 10.2307/41166019
- Hong, J., Zhang, Y., & Ding, M. (2018). Sustainable supply chain management practices, supply chain dynamic capabilities, and enterprise performance. *Journal of Cleaner Production*, 172, 3508-3519. doi: 10.1016/j.jclepro.2017.06.093
- Kaynak, H., & Hartley, J. L. (2006). Using replication research for just-in-time purchasing construct development. *Journal of Operations Management*, 24(6), 868-892. doi: 10.1016/j.jom.2005.11.006
- Kessler, E. H., & Chakrabarti, A. K. (1996). Innovation speed: A conceptual model of context, antecedents, and outcomes. *Academy of Management Review*, 21(4), 1143-1191. doi: 10.5465/amr.1996.9704071866
- Kim, D. Y. (2013). Relationship between supply chain integration and performance. *Operations Management Research*, 6(1-2), 74-90. doi: 10.1007/s12063-013-0079-0
- Koufteros, X. A., Vonderembse, M. A., & Doll, W. J. (1997). Competitive capabilities: measurement and relationships. *Proceedings Decision Science Institute*, 3(1), 1067-1068.
- Koufteros, X., Vonderembse, M., & Jayaram, J. (2005). Internal and external integration for product development: the contingency effects of uncertainty, equivocality, and platform strategy. *Decision Sciences*, 36(1), 97-133. doi: 10.1111/j.1540-5915.2005.00067.x
- Levi, D. S., Kaminsky, P., & Levi, E. S. (2003). *Designing and managing the supply chain: Concepts, strategies, and case studies*. New York: McGraw-Hill.

- Lewis, M. A. (2000). Lean production and sustainable competitive advantage. *International Journal of Operations & Production Management*, 20(8), 959-978. doi: 10.1108/01443570010332971
- Moeller, S., Fassnacht, M., & Klose, S. (2006). A framework for supplier relationship management (SRM). *Journal of Business-to-Business Marketing*, 13(4), 69-91. doi: 10.1300/J033v13n04\_03
- Mogre, R., Lindgreen, A., & Hingley, M. (2017). Tracing the evolution of purchasing research: future trends and directions for purchasing practices. *Journal of Business & Industrial Marketing*, 32(2), 251-257. doi: 10.1108/JBIM-01-2016-0004
- Nimeh, H. A., Abdallah, A. B., & Sweis, R. (2018). Lean supply chain management practices and performance: empirical evidence from manufacturing companies. *International Journal of Supply Chain Management*, 7(1), 1-15. Retrieved from [www.researchgate.net/publication/323454401\\_Lean\\_Supply\\_Chain\\_Management\\_Practices\\_and\\_Performance\\_Empirical\\_Evidence\\_from\\_Manufacturing\\_Companies](http://www.researchgate.net/publication/323454401_Lean_Supply_Chain_Management_Practices_and_Performance_Empirical_Evidence_from_Manufacturing_Companies)
- Penrose, E. (1959). *The Theory of the Growth of the Firm*. New York: John Wiley and Sons.
- Petersen, K. J., Handfield, R. B., & Ragatz, G. L. (2005). Supplier integration into new product development: coordinating product, process and supply chain design. *Journal of Operations Management*, 23(3-4), 371-388. doi: 10.1016/j.jom.2004.07.009
- Porter, M. E. (1991). Towards a dynamic theory of strategy. *Strategic Management Journal*, 12(S2), 95-117. doi: 10.1002/smj.4250121008
- Porter, M. E. (2008). *Competitive strategy: Techniques for analyzing industries and competitors*. New York: Simon and Schuster.
- Prajogo, D., Chowdhury, M., Yeung, A. C., & Cheng, T. C. E. (2012). The relationship between supplier management and firm's operational performance: A multi-dimensional perspective. *International Journal of Production Economics*, 136(1), 120-130. doi: 10.1016/j.ijpe.2011.09.022
- Salehi, M., Majbouri Yazdi, H., & Nekoei, M. (2018). The effect of communication capabilities of suppliers and external green integration on the green and financial performance in Iran. *Qualitative Research in Financial Markets*, 10(3), 309-323. doi: 10.1108/QRFM-11-2017-0100
- Sindiga, L. K., Paul, S. N., & Mbura, L. K. (2019). Influence of procurement management practices on performance of construction firms in Nairobi County, Kenya. *International Academic Journal of Procurement and Supply Chain Management*, 3(1), 143-163. Retrieved from [http://www.iajournals.org/articles/iajpscm\\_v3\\_i1\\_143\\_163.pdf](http://www.iajournals.org/articles/iajpscm_v3_i1_143_163.pdf)
- Spekman, R. E., Spear, J., & Kamauff, J. (2002). Supply chain competency: learning as a key component. *Supply Chain Management*, 7(1), 41-55. doi: 10.1108/13598540210414373
- Terpend, R., Tyler, B. B., Krause, D. R., & Handfield, R. B. (2008). Buyer-supplier relationships: Derived value over two decades. *Journal of Supply Chain Management*, 44(2), 28-55. doi: 10.1111/j.1745-493X.2008.00053.x
- Thompson, J. D. (1967). *Organizations in action*. New York: McGraw Hill.
- Tseng, S. M. (2014). The impact of knowledge management capabilities and supplier relationship management on corporate performance. *International Journal of Production Economics*, 154, 39-47. doi: 10.1016/j.ijpe.2014.04.009

- Wagner, S. M. (2011). Supplier development and the relationship life-cycle. *International Journal of Production Economics*, 129(2), 277-283. doi: 10.1016/j.ijpe.2010.10.020
- Wisner, J. D. (2003). A structural equation model of supply chain management strategies and firm performance. *Journal of Business Logistics*, 24(1), 1-26. doi: 10.1002/j.2158-1592.2003.tb00030.x
- Wook Kim, S. (2006). Effects of supply chain management practices, integration and competition capability on performance. *Supply Chain Management*, 11(3), 241-248. doi: 10.1108/13598540610662149
- Yang, Z., Zhang, H., & Xie, E. (2017). Performance feedback and supplier selection: A perspective from the behavioral theory of the firm. *Industrial Marketing Management*, 63, 105-115. doi: 10.1016/j.indmarman.2016.12.003
- Zhang, C., & Dhaliwal, J. (2009). An investigation of resource-based and institutional theoretic factors in technology adoption for operations and supply chain management. *International Journal of Production Economics*, 120(1), 252-269. doi: 10.1016/j.ijpe.2008.07.023

## Contact information

### **Christina Appiah-Nimo**

Tomas Bata University in Zlín, Faculty of Management and Economics  
Mostní 5139, 76001, Zlín, Czech Republic  
E-mail: appiah\_nimo@utb.cz  
ORCID: 0000-0001-5597-3553

### **Daniel Ofori**

University of Cape Coast, School of Business  
Cape Coast, Ghana  
E-mail: dofori@ucc.edu.gh  
ORCID: 0000-0002-7546-6716

### **Michael Adu Kwarteng, Ph.D.**

Tomas Bata University in Zlín, Faculty of Management and Economics  
Mostní 5139, 76001, Zlín, Czech Republic  
E-mail: kwarteng@utb.cz  
ORCID: 0000-0002-6787-0401

### **doc. Ing. Miloslava Chovancová, CSc.**

Tomas Bata University in Zlín, Faculty of Management and Economics  
Mostní 5139, 76001, Zlín, Czech Republic  
E-mail: chovancova@utb.cz  
ORCID: 0000-0002-9244-9563

doi: 10.7441/dokbat.2019.004

# THE INTEGRATED REPORTING “STAKEHOLDER RELATIONSHIPS” PRINCIPLE IN THE EUROPEAN FINANCIAL SECTOR

*Bianca Raluca Bădițoiu*

## **Abstract**

The article comprises a basic analysis of the quality and complexity of the content found in 2018 integrated reports, for 12 European companies from the financial sector (banking and insurance sectors), which have implemented integrated reporting by adhering to the IIRC Initiative, appearing in the IR Example Database. According to IIRC, there are six guiding principles of integrated reporting, which have to be considered in what regards the preparation of an integrated report, with the purpose of informing the content of the report and the way in which information is presented. This article focuses on the perspective of the relationships between companies and their stakeholders and the quality of information regarding this aspect. The methodology used in this study consists in scoring the presence of information regarding the main stakeholders of the companies, namely: shareholders and investors, employees, customers and suppliers –named as business partners and community and environment. The main results of the study revealed information about the companies which reported the most information within their reports regarding the “stakeholder relationships” principle and the ones which reported the least information regarding this aspect. The study also revealed potential benefits, such as: company reputation and brand image enhancement, creating or improving the reputation among investors and financial institutions, reducing business risk (i.e. facilitating financing access), competitive advantage in terms of access to resources and many others, for those companies that implement integrated reports.

**Keywords:** *integrated reporting, stakeholder relationships, integrated reporting principles, content analysis, IIRC, information disclosure*

## **1 INTRODUCTION**

The business-investors-society relationship is going through a non-precedented scrutiny process. Reporting cycles with numerous flaws such as short-term focus, backward approach, box-thinking mentality and fragmented approach have to be replaced. The usual reports have become lengthy and overly complex, lacking a holistic approach which has led businesses into facing significant compliance burdens. Investors do not receive the necessary information, short termism, focus only on financial information and even lack of trust are all situations in which the capital markets are finding themselves lately. Integrated reporting though is a salvaging method, based on communication between investors and businesses and it has already been adopted by numerous businesses worldwide, according to [integrated-reporting.org](http://integrated-reporting.org). It functions based on existing information rather than trying to create something new and its contribution towards financial stability and sustainable development has been demonstrated by world renowned academics. Specifically speaking, integrated reporting is a strategic and futuristic communication about the manner in which organizations draw their various resources and about their relationships and the capital created over time (IIRC, 2013). Since its introduction into practice in the 2000s, the integrated reporting has been promoted via the International Integrated Reporting Committee (IIRC), established in 2010, subsequently renamed International Integrated Reporting Council, as a solution for the increasing demands of stakeholders for

a wider selection of decision-useful information, in contrast with conventional corporate financial reports (de Villiers, Hsiao & Maroun, 2017).

This article focuses on examining the quality and complexity of information regarding the relationships between companies and their stakeholders by analysing integrated reports of 12 European companies from the financial- banking and insurances sectors using a content analysis, and is of interest for all integrated reports users and all stakeholders. The main results of the study revealed information regarding the “stakeholder relationships” principle of the companies which reported the most information within their reports and the ones which reported the least information.

This article is divided into 4 sections, apart from the introduction. Literature Review offers a general view on the concept of integrated reporting and on the information available in specialty literature regarding the perception on this subject. In what follows, the paper continues with a description of the methodology and a statement of results and findings. The end of the paper consists in the conclusions of this study, recognizing the limitations of the research and comprising a comparative discussion as well, on the results of various studies.

## **2 LITERATURE REVIEW**

Integrated report has been described by the IIRC as “a concise communication about how an organization’s strategy, governance, performance and prospects, in the context of its external environment, lead to the creation of value over the short, medium and long term” (IIRC, 2013). “The primary purpose of an integrated report is to explain to financial capital providers how an organization creates value over time” (IIRC, 2013). It provides relevant information, both financial and non-financial, for all stakeholders that affect or can be affected by the organization. According to the IIRC, integrated reporting “has a combined emphasis on conciseness, strategic focus and future orientation, the connectivity of information and the capitals and their interdependencies emphasizing the importance of integrated thinking within the organization” (IIRC, 2013). IIRC defined integrated thinking as “the active consideration by an organization of the relationships between its various operating and functional units and the capitals that the organization uses or affects. Integrated thinking leads to integrated decision-making and actions that consider the creation of value over the short, medium and long term” (IIRC, 2013). There are six forms of capitals suggested by IIRC: financial, manufactured, intellectual, human, social and relationship, and natural capital (IIRC, 2013).

Theories linked to integrate reporting are relatively new, being connected to corporate governance theories, revealing economic, social, managerial, financial and environmental aspects in an increasingly complex business environment. A remarkable interest has been noticed in speciality literature regarding the subject of integrated reporting. Some studies have been focused on positive aspects of integrated reporting, whereas others have pointed out the difficulties in implementing it, or critiques regarding different aspects of integrated reports of firms.

According to several authors, the expectations regarding the integrated reporting included provision of additional decision-useful information, that could be of help in the formulation of new strategies (Adams, 2015), assessment of organizational value (de Villiers, Venter & Hsiao, 2017), facilitation of capital increase from new foreign investors (Macias & Farfan-Lievano, 2017), evaluation of the organization’s impact on human rights or other issues of global interest (Abeysekera, 2013) and last but not least, it was also expected to be of use to the public sector (Guthrie, Manes-Rossi & Orelli, 2017). Rinaldi, Unerman and de Villiers (2018) focused on the integrated reporting journey, highlighting the dynamics and interrelationships of the concept in literature, by using the Idea Journey Framework, which sets out five phases of journey in the

development and implementation of an idea: generation, elaboration, championing, production and impact of an idea (Rinaldi, Unerman and de Villiers, 2018). Other studies have focused on the perspective of preparers and other stakeholders, questioning the level of knowledge and interest regarding integrated reporting (Adhariani & de Villiers, 2018). Rivera-Arrubla, Zorio-Grima and García-Benau, (2017) analysed the quality of the content of integrated reporting and the determining factors. A similar study focused on the association between the quality of IR and different corporate characteristics, such as: profitability, leverage, board size, gender diversity and firm size concluding in a positive significant relationship between the length and quality of an integrated report (Iredele, 2019). De Villiers, Rinaldi and Unerman (2014) focused on the “insights” –such as the development of the concept of integrated reporting, the theoretical and empirical challenges of adopting the concept- and created an “agenda” for future research. McNally, Cerbone and Maroun (2017) focused as well on the challenges of the concept, regarding the preparing of an integrated report. Other studies find significant barriers in the implementation of the IIRC framework, such as: the numerous different explanations of the concept of IR, the vague and abstractly defined terms used in explaining integrated reporting (“integrated thinking” and “value creation”), insecure usefulness for the value relevance, improper internal processes and lack of regulations (Dumay et al., 2017).

Of particular interest for this article are studies which have investigated different perceptions on the integrated reporting principle, conducted in various countries and from the points of view of different stakeholders. According to Chaidali and Jones (2017), when considering integrated reporting implementation, corporate report preparers display some concerns regarding the format and the length of integrated reports. Other issues of the integrated reports mentioned by preparers include trust in the motives of IIRC professionals and credibility of the IIRC board members, uncertainty of benefits, no adequate or clear guidelines and increased preparation costs (Chaidali and Jones, 2017). The perceptions of shareholders and potential investors have also been studied. For example, Atkins and Maroun (2015) researched the first reactions of the South African institutional investors towards some of the first integrated reports prepared by companies listed on the Johannesburg Securities Exchange. The research was based on interviews conducted with 20 experts from the South African investment community. They considered integrated reporting (IR) as an improvement of traditional annual reports but they mentioned several downsides as well such as long, repetitive and difficult structures which should be reconsidered in the future due to the fact that they can “detract from the usefulness of the reports and undermine the development of an integrated thinking ethos” (Atkins and Maroun, 2015). Fund managers and equity analysts employed by global investment houses also have low consideration towards IR according to Slack and Tsalavatos (2018). Sell-side analysts do not find the information contained in integrated reports as sufficient, nor being in their preferred format, thus stating that it is of little usefulness (Abhayawansa, Elijido & Dumay, 2018). Other types of stakeholders on the other hand, such as the nonfinancial information users show more support towards the IR in a study conducted in Australia by Stubbs and Higgins (2018). They thought that in time, the IR would become the reporting norm, with the help of market forces. Most of the participants stated that it was too early for a regulatory reform, however, half of the investors supported the idea that IR should become mandatory in order to encourage more substantive and qualitative disclosures (Stubbs & Higgins, 2018).

A key insight of this article is that the academic literature has not yet covered all aspects regarding the content and quality of integrated reporting guiding principles. While many studies focused on materiality, consistency and comparability, as mentioned above in this section, little interest has been shown for the other guiding principles of an integrated report. This reveals opportunities for future research to explore, not only the matter of the “stakeholder



relationships” principle, but also the strategic focus and future orientation, the connectivity of information, the conciseness and the reliability and completeness of integrated reports.

### 3 METHODOLOGY

According to IIRC, there are six principles of integrated reporting, which have to be considered in what regards the preparation of an integrated report, with the purpose of informing the content of the report and the way in which information is presented, namely: strategic focus and future orientation, connectivity of information, stakeholder relationships, materiality, conciseness, reliability and completeness and consistency and comparability (IIRC, 2013).

This article focuses on one of these principles, mainly the “stakeholder relationships” principle using a content analysis (scanning of integrated reports), by classifying the most important stakeholders (shareholders and investors, employees, customers and suppliers – defined as business partners and community and environment) for 12 European companies from the financial and insurances sector and scored the presence of information regarding these stakeholders, as follows: the companies which included information regarding their stakeholders in their integrated reports received one point and the ones which did not include any information received zero points. The creditors, a very important category of stakeholders for any company, cannot be analysed from the perspective of the information from integrated reports, due to the fact that they are almost exclusively part of the inside of the banking system. The specific of creditors from the banking sector is atypical. Data were obtained from gathering information from the 2018 integrated reports of 12 European companies from the financial sector and insurances sector (AXA, 2019; Caixa Bank, 2019; Creval, 2019; Direct Line Group, 2019; Fideuram, 2019; FMO, 2019; Garanti Bank, 2019; Generali, 2019; HSBC, 2019; ING, 2019; Santander, 2019; UniCredit, 2019).

Tab. 1 – Main Stakeholders. Source: own research

<b>SHAREHOLDERS &amp; INVESTORS</b>
General information regarding the shareholders
Information regarding the shareholders concentration
Information regarding the geographical diversity of shareholders
Information regarding the board members’ percentage of share capital
Information regarding the dividend policy
<b>EMPLOYEES</b>
General information (structure, gender)
Information regarding employees qualifications
Information regarding the continuous development of employees (trainings, team-buildings)
Information regarding work conflicts
Information regarding rewards, promotions, dismissal policies, whistle-blowing
<b>CUSTOMERS AND SUPPLIERS -BUSINESS PARTNERS</b>
General information regarding the customers/suppliers
Information regarding the types of activities and services provided for customers
Information regarding the structure of the customers
Information regarding the technological innovation in services
Information regarding the responsible politics in the relationship with the business partners
<b>COMMUNITY AND ENVIRONMENT</b>
Ingredient Sourcing & Waste
Climate & Renewable Energy
Water Consumption & CO2
Involvement in Communities
Involvement in Entrepreneurship/ Social entrepreneurship

## 4 FINDINGS AND RESULTS

By means of descriptive statistics we obtained the following indicators: Standard Error, Median, Mode, Sample Variance, Kurtosis, Skewness, Range, Minimum and Maximum, which we eliminated from the tables due to the fact that they are not significant for the analysed data set (only 12 companies analysed).

Tab. 2 – General statistical information regarding shareholders and investors. Source: own research

	ASSICURAZIONI GENERALI	AXA	BANCA FIDEURAM	BANCA POPULAR ESPANOL	CAIXA BANK	CREDITO VALTELLINESE	DIRECT LINE GROUP	FMO	GARANTI BANK	HSBC	ING GROUP	UNICREDIT
Mean	0.80	0.40	0.40	1	0.80	0.20	0.40	0.80	0.80	1	0.80	0.60
Standard Deviation	0.45	0.55	0.55	0	0.45	0.45	0.55	0.45	0.45	0	0.45	0.55

On the analysed set of data, the maximum mean regarding the shareholders and investors information is 1 and the minimum mean is 0,2 (Table 2). Thus, most companies reveal information about their shareholders and investors in their integrated reports. The mean shows us that 7 out of 12 analysed companies have more information about their shareholders and investors (Assicurazioni Generali, Banca Popular Espanol, Caixa Bank, FMO, Garanti Bank, HSBC and ING Group), whereas 4 out of 12 find themselves in the middle, with some information (Axa, Banca Fideuram, Direct line Group and Unicredit), and one of them revealed little information – Credito Valtellinese. The value of the standard deviation is relatively low because of the sample and it does not vary. Thus, the standard deviation is not significant.

All companies revealed general information about their shareholders and only 58% detailed the shareholders' concentration, 67% described the geographical diversity of their shareholders, 17% mentioned the board members' percentage of share capital and 92% reported their dividend policy (Table 3).

Tab. 3 – Detailed statistical information regarding the shareholders and investors. Source: own research

	General information regarding the shareholders	Information regarding the shareholders' concentration	Information regarding the geographical diversity of shareholders	Information regarding the board members' percentage of share capital	Information regarding the dividend policy
Percentage	100%	58%	67%	17%	92%
Sum	12	7	8	2	11
Base	12	12	12	12	12

The maximum mean regarding the employee's information is 1 and the minimum mean is 0.4. Table 4 indicates that only 5 companies out of 12 reveal much information about their employees (Banca Fideuram, Banca Popular Espanol, Direct Line Group, HSBC and Unicredit) and the other 7 out of 12 companies find themselves in the middle, with some information (Assicurazioni Generali, Axa, Caixa Bank, Credito Valtellinese, FMO, Garanti Bank, ING Group).

Tab. 4 – General statistical information regarding the employees. Source: own research

	ASSICURAZIONI GENERALI	AXA	BANCA FIDEURAM	BANCA POPULAR ESPANOL	CAIXA BANK	CREDITO VALTELLINESE	DIRECT LINE GROUP	FMO	GARANTI BANK	HSBC	ING GROUP	UNICREDIT
Mean /Count	0.40	0.40	1	1	0.60	0.60	0.80	0.60	0.60	0.80	0.60	0.80
Standard Deviation	0.55	0.55	0	0	0.55	0.55	0.45	0.55	0.55	0.45	0.55	0.45

The value of the standard deviation is relatively low because of the sample (12 companies) and it does not vary. Thus, the standard deviation is not significant. Almost (92%) of the analysed companies reported general information about employees, only 25% revealed information regarding the employees' qualifications and all companies gave information about the continuous development of employees (trainings, team-buildings). 33% of them mentioned details about work conflicts and 92% shared their information regarding rewards, promotions, dismissal policies and whistle-blowing (Table 5).

Tab. 5 – Detailed statistical information regarding the employees. Source: own research

	General information (structure, gender)	Information regarding employees qualifications	Information regarding the continuous development of employees (trainings, team-buildings)	Information regarding work conflicts	Information regarding rewards, promotions, dismissal policies, whistle-blowing
Percentage	92%	25%	100%	33%	92%
Sum	11	3	12	4	11
Base	12	12	12	12	12

The maximum mean regarding the business partner's information is 1 and the minimum mean is 0.4. Table 6 indicates that most of the companies (9 out of 12) reveal much information about their business partners (Axa, Banca Fideuram, Banca Popular Espanol, Credito Valtellinese, FMO, Garanti Bank, HSBC, ING Group and Unicredit) and the rest of 3 out of 12 companies find themselves in the middle, with some information (Assicurazioni Generali, Caixa Bank and Direct Line Group).

Tab. 6 – General statistical information regarding the business partners. Source: own research

	ASSICURAZIONI GENERALI	AXA	BANCA FIDEURAM	BANCA POPULAR ESPANOL	CAIXA BANK	CREDITO VALTELLINESE	DIRECT LINE GROUP	FMO	GARANTI BANK	HSBC	ING GROUP	UNICREDIT
Mean	0.60	1	1	1	0.40	0.80	0.40	0.80	1	1	1	1
Standard Deviation	0.55	0	0	0	0.55	0.45	0.55	0.45	0	0	0	0

The value of the standard deviation is relatively low because of the sample (12 companies) and it does not vary. Thus, the standard deviation is not significant. Sixty-seven percent of the analysed companies reported general information about their business partners, all companies revealed information regarding the types of activities and services provided for their customers,

75% gave information about the structure of their customers, all companies mentioned details about the technological innovation in services and 75% shared their information regarding responsible politics in the relationship with business partners (Table 7).

Tab. 7 – Detailed statistical information regarding business partners. Source: own research

	General information regarding the customers /suppliers	Information regarding the types of activities and services provided for customers	Information regarding the structure of the customers	Information regarding the technological innovation in services	Information regarding the responsible politics in the relationship with the business partners
Percentage	67%	100%	75%	100%	75%
Sum	8	12	9	12	9
Base	12	12	12	12	12

The maximum mean regarding the community and environment information is 1 and the minimum mean is 0.6. Table 8 indicates that most of the companies (10 out of 12) reveal much information about the community and the environment they are working in (Axa, Banca Fideuram, Banca Popular Espanol, Caixa Bank, Credito Valtellinese, Direct Line Group, FMO, Garanti Bank, ING Group and Unicredit) and the rest of 2 out of 12 companies find themselves in the middle, revealing some information (Assicurazioni Generali and HSBC).

Tab. 8 – General statistical information regarding the community & environment. Source: own research

	ASSICURAZIONI GENERALI	AXA	BANCA FIDEURAM	BANCA POPULAR ESPANOL	CAIXA BANK	CREDITO VALTELLINESE	DIRECT LINE GROUP	FMO	GARANTI BANK	HSBC	ING GROUP	UNICREDIT
Mean /Count	0.60	0.80	0.80	1	0.80	0.80	0.80	1	0.80	0.60	1	1
Standard Deviation	0.55	0.45	0.45	0	0.45	0.45	0.45	0	0.45	0.55	0	0

The value of the standard deviation is relatively low because of the sample (12 companies) and it does not vary. Thus, the standard deviation is not significant. Seventy-five percent of the analysed companies reported information regarding ingredient sourcing and waste, all companies' revealed information regarding their actions toward climate and renewable energy, water consumption and CO2 and their involvement in the communities while only 42% of them gave information about their involvement in entrepreneurship or social entrepreneurship (Table 9).

Tab. 9 – Detailed statistical information regarding the community & environment. Source: own research

	Ingredient Sourcing & Waste	Climate & Renewable Energy	Water Consumption & CO2	Involvement in Communities	Involvement in Entrepreneurship/ Social entrepreneurship
Percentage	75%	100%	100%	100%	42%
Sum	9	12	12	12	5
Base	12	12	12	12	12

## 5 DISCUSSION AND CONCLUSIONS

The article comprises an analysis of the quality and complexity of the content found in 2018 integrated reports, from the perspective of the “stakeholder relationships” principle, for companies from the financial-banking and insurance sectors, which have implemented integrated reporting. The studied companies are exclusively European at origin and they have transparency policy regarding their reports, through the IIRC (IIRC, 2019).

The companies, which reported the most information regarding the shareholders and investors, are: Banca Popular Espanol and HSBC and the one which reported the least information from all analysed companies is Credito Valtellinese.

Regarding the information about employees, Banca Fideuram and Banca Popular Espanol shared the most, while Assicurazioni Generali and Axa shared the least.

The business partner’s information were described most in the integrated reports of: Axa, Banca Fideuram, Banca Popular Espanol, Garanti Bank, HSBC, ING Group and Unicredit and the least in the integrated reports of: Caixa Bank and Direct Line Group.

Community and Environment related details were best described by: Banca Popular Espanol, FMO, ING Group and Unicredit, and the smallest amount of information was in the integrated reports of: Assicurazioni Generali and HSBC.

As a general conclusion of this study, we can state that the content and the quality of the information regarding the stakeholders of the studied companies do not depend on the length or format of the integrated reports. Regarding their conciseness, we agree with other authors such as Chaidali and Jones, 2017, which consider these matters, related to report length and format, problematic. One aspect regarding the difficulties of this study is related to the previously mentioned fact, namely that the analysed integrated reports differ both in terms of data presentation, as well as in their complexity and volume of content. This said, it is very difficult to compare the information within those reports. Future research perspectives consist in creating a larger database and constructing a scale with different criteria, following successful studies of integrated reports from different sectors. The studied group is small, but in order to create a larger database, large and various volumes of information must be analysed, which unfortunately are distributed in different forms, without a similar framework.

On the other side, in accordance with Stubbs and Higgins (2018), half of the investors supported the idea that IR should become mandatory in order to encourage more substantive and qualitative disclosures (Stubbs & Higgins, 2018). Furthermore, this fact supports the idea that this study is of interest for integrated report users and also for all stakeholders, which can result in many benefits for the involved companies, such as: company reputation and brand image enhancement, community support for different operations, creating or improving the reputation among investors and financial institutions, reducing business risk (i.e. facilitating financing access), increasing employee motivation and productivity, competitive advantage in terms of access to resources, improvement of corporate culture, meeting stakeholder expectations and providing valuable data for strategic planning and future orientation.

With respect to the limitations of this article, one of the major limitations is linked to the small number of companies included in the study, the database being, consequently, quite small. Statistical interpretation in this case is irrelevant. Furthermore, the study is limited to a single continent – Europe and only two similar sectors: financial and insurances sector. To broaden the boundaries of this research, incorporating a greater number of reports for different sectors could result in a comparative analysis that could reveal the differences regarding the stakeholder’s information within these sectors.

Another significant limitation of this article is based on the fact that the “creditors” stakeholders’ category couldn’t be analysed for the financial-banking and insurance sectors. The methodology could also be included in the category of limitations of the study, because of the subjectivity involved in the scoring process.

However, despite these limitations, this article revealed significant information about the content of integrated reporting and the quality of information regarding the relationship of 12 companies with their stakeholders.

## Acknowledgement

This work was co-financed from the European Social Fund through Operational Programme Human Capital 2014-2020, project number POCU/380/6/13/125015 “Development of entrepreneurial skills for doctoral students and postdoctoral researchers in the field of economic sciences”

## References

- Abeyssekera, I. (2013). A template for integrated reporting. *Journal of Intellectual Capital*, 14(2), 227-245. doi: 10.1108/14691931311323869
- Abhayawansa, S., Eljido- Ten, E., & Dumay, J. (2018). A practice theoretical analysis of the irrelevance of integrated reporting to mainstream sell-side analysts. *Accounting & Finance*, 59(3), 1615-1647. doi: 10.1111/acfi.12367
- Adams, C. A. (2015). The international integrated reporting council: a call to action. *Critical Perspectives on Accounting*, 27, 23-28. doi: 10.1016/j.cpa.2014.07.001
- Adhariani, D., & de Villiers, C. (2018). Integrated reporting: perspectives of corporate report preparers and other stakeholders. *Sustainability Accounting, Management and Policy Journal*, 10(1), 126-156. doi: 10.1108/SAMPJ-02-2018-0043
- Atkins, J., & Maroun, W. (2015). Integrated reporting in South Africa in 2012: Perspectives from South African institutional investors. *Meditari Accountancy Research*, 23(2), 197-221. doi: 10.1108/MEDAR-07-2014-0047
- AXA (2019). *Axa Integrated Report 2018*. Retrieved from [https://www-axa-com.cdn.axa-contento-118412.eu/www-axa-com%2F0a5e0bd9-78f2-4ef8-b32c-1d3d35ddce80\\_axa-ri2018-en-accessible.pdf](https://www-axa-com.cdn.axa-contento-118412.eu/www-axa-com%2F0a5e0bd9-78f2-4ef8-b32c-1d3d35ddce80_axa-ri2018-en-accessible.pdf)
- Caixa Bank (2019). Group Management Report of CaixaBank Group 2018. Retrieved from [https://www.caixabank.com/deployedfiles/caixabank/Estaticos/PDFs/Informacion\\_accionistas\\_inversores/IDG\\_31122018\\_WEB\\_ENG.pdf](https://www.caixabank.com/deployedfiles/caixabank/Estaticos/PDFs/Informacion_accionistas_inversores/IDG_31122018_WEB_ENG.pdf)
- Chaidali, P., & Jones, M. J. (2017). It’s a matter of trust: Exploring the perceptions of Integrated Reporting preparers. *Critical Perspectives on Accounting*, 48, 1-20. doi: 10.1016/j.cpa.2017.08.001
- Creval (2019). *2018 Consolidated Non-Financial Statement*. Retrieved from [http://www.gruppocreval.com/cartellaPDF/en\\_parsedPDF/en\\_2018/DCNF\\_2018\\_eng\\_web.pdf](http://www.gruppocreval.com/cartellaPDF/en_parsedPDF/en_2018/DCNF_2018_eng_web.pdf)
- de Villiers, C., Hsiao, P. C. K., & Maroun, W. (2017). Developing a conceptual model of influences around integrated reporting, new insights, and directions for future research. *Meditari Accountancy Research*, 25(4), 450-460. doi: 10.1108/MEDAR-07-2017-0183

- de Villiers, C., Rinaldi, L., & Unerman, J. (2014). Integrated reporting: insights, gaps and an agenda for future research. *Accounting, Auditing & Accountability Journal*, 27(7), 1042-1067. doi: 10.1108/AAAJ-06-2014-1736
- de Villiers, C., Venter, E. R., & Hsiao, P. C. K. (2017). Integrated reporting: background, measurement issues, approaches and an agenda for future research. *Accounting & Finance*, 57(4), 937-959. doi: 10.1111/acfi.12246
- Direct Line Group (2019). *Annual Report 2018*. Retrieved from <https://www.directlinegroup.co.uk/en/investors/annual-report-2018.html>
- Dumay, J., Bernardi, C., Guthrie, J., & La Torre, M. (2017). Barriers to implementing the International Integrated Reporting Framework: A contemporary academic perspective. *Meditari Accountancy Research*, 25(4), 461-480. doi: 10.1108/MEDAR-05-2017-0150
- Fideuram (2019). *Integrated Annual Report 2018*. Retrieved from [http://www.fideuram.it/media/3588/ar\\_2018\\_eng.pdf](http://www.fideuram.it/media/3588/ar_2018_eng.pdf)
- FMO (2019). *Annual Report 2018*. Retrieved from [https://annualreport.fmo.nl/2018/FbContent.ashx/pub\\_1002/downloads/v190510151906/2018%20FMO%20Annual%20Report.pdf](https://annualreport.fmo.nl/2018/FbContent.ashx/pub_1002/downloads/v190510151906/2018%20FMO%20Annual%20Report.pdf)
- Garanti BBVA Investor Relations 2018 Integrated Annual Report (n.d.). [PDF file]
- Garanti Bank (2019). *2018 Integrated Annual Report*. Retrieved from: [https://www.garantibbvainvestorrelations.com/en/images/entegre-faaliyet-raporu-2018/GB18\\_ENG.pdf](https://www.garantibbvainvestorrelations.com/en/images/entegre-faaliyet-raporu-2018/GB18_ENG.pdf)
- Generali (2019). *Report Archive 2018*. Retrieved from <https://www.generali.com/investors/reports-and-presentations/report-archive#2018>
- Guthrie, J., Manes-Rossi, F., & Orelli, R. L. (2017). Integrated Reporting and Integrated Thinking in Italian Public Sector Organisations. *Meditari Accountancy Research*, 25(4), 553-573. doi: 10.1108/MEDAR-06-2017-0155
- HSBC (2019). *Annual Report*. Retrieved from <https://www.hsbc.com/investors/results-and-announcements/annual-report>
- IIRC (2013). *The International <IR> Framework: Integrated Reporting*. Retrieved from <https://integratedreporting.org/wp-content/uploads/2015/03/13-12-08-THE-INTERNATIONAL-IR-FRAMEWORK-2-1.pdf>
- IIRC (2019). *Integrated Reporting: <IR> reporters*. Retrieved from [http://examples.integratedreporting.org/search\\_reporter?x=44&y=9&organisation\\_region=1&fbclid=IwAR32\\_MM7hnJkmmtnytJAbblhxqvhGGktp4AW2OHTHTO8MZ-rW7SWvYEAQnrM](http://examples.integratedreporting.org/search_reporter?x=44&y=9&organisation_region=1&fbclid=IwAR32_MM7hnJkmmtnytJAbblhxqvhGGktp4AW2OHTHTO8MZ-rW7SWvYEAQnrM)
- ING (2019). *Annual Reports: 2018*. Retrieved from <https://www.ing.com/Investor-relations/Financial-performance/Annual-reports.htm>
- Iredele, O. O. (2019). Examining the association between quality of integrated reports and corporate characteristics. *Heliyon*, 5(7), 1-8. doi: 10.1016/j.heliyon.2019.e01932
- Macias, H. A., & Farfan-Lievano, A. (2017). Integrated reporting as a strategy for firm growth: multiple case study in Colombia. *Meditari Accountancy Research*, 25(4), 605-628. doi: 10.1108/MEDAR-11-2016-0099

- McNally, M. A., Cerbone, D., & Maroun, W. (2017). Exploring the challenges of preparing an integrated report. *Meditari Accountancy Research*, 25(4), 481-504. doi: 10.1108/MEDAR-10-2016-0085
- Rinaldi, L., Unerman, J., de Villiers, C. (2018). Evaluating the integrated Reporting journey: insights, gaps and agendas for future research. *Accounting, Auditing & Accountability Journal*, 31(5), 1294-1318. doi: 10.1108/AAAJ-04-2018-3446
- Rivera-Arrubla, Y. A., Zorio-Grima, A., & García-Benau, M. A. (2017). Integrated reports: disclosure level and explanatory factors. *Social Responsibility Journal*, 13(1), 155-176. doi: 10.1108/SRJ-02-2016-0033
- Santander (2019). *Auditors' report and consolidated annual accounts 2018*. Retrieved from [https://www.santanderannualreport.com/2018/sites/default/files/auditors\\_report\\_and\\_consolidated\\_annual\\_accounts.pdf](https://www.santanderannualreport.com/2018/sites/default/files/auditors_report_and_consolidated_annual_accounts.pdf)
- Slack, R., & Tsalavoutas, I. (2018). Integrated reporting decision usefulness: mainstream equity market views. *Accounting Forum*, 42(2), 184-198. doi: 10.2139/ssrn.2959745
- Stubbs, W., & Higgins, C. (2018). Stakeholders' perspectives on the role of regulatory reform in integrated reporting. *Journal of Business Ethics*, 147(3), 489-508. doi: 10.1007/s10551-015-2954-0
- UniCredit (2019). *2018 Integrated Report*. Retrieved from [https://www.unicreditgroup.eu/content/dam/unicreditgroup-eu/documents/en/sustainability/sustainability-reports/2018/IR\\_ENG2018\\_Print.pdf](https://www.unicreditgroup.eu/content/dam/unicreditgroup-eu/documents/en/sustainability/sustainability-reports/2018/IR_ENG2018_Print.pdf);

## Contact information

### **Bianca Raluca Bădițoiu**

Vest University of Timisoara, Faculty of Economics and Business Administration  
Pestalozzi Street 16, Timisoara 300115, Timis, Romania

E-mail: bianca.baditoiu@e-uvt.ro

ORCID: 0000-0001-7365-2753

doi: 10.7441/dokbat.2019.005



# CONTRACTUAL ARRANGEMENTS AND UNFAIR TRADING PRACTICES: EVIDENCE FROM DAIRY FARM SECTOR IN SLOVAKIA

*Katarína Baráthová, Lucia Vargová, Martin Jamrich*

## Abstract

In recent years, the agricultural sector in Slovakia has faced difficult challenges. Different development patterns of the market have led to significant structural changes, which severely impacted especially dairy farms. Dairy farmers occupy a weak position in the food supply chain whereas dairy processors and retailers are highly concentrated. As a result, differences in bargaining power may lead to competition inequalities. The abuse of these imbalances may lead to the occurrence of unfair practices. Because the research of the presence of unfair trading practices in the dairy sector is limited and there has been no evidence of this kind of studies in Slovakia, the purpose of this paper is to investigate UTPs occurrence in contractual arrangements among primary milk producers in Slovakia through the survey carried out in 2 regions. The results show that occurrence of UTPs in dairy sector in Slovakia is very frequent. 87% of respondents reported at least 1 UTP in relationship with their main buyer.

*Keywords: dairy sector, unfair trading practices, milk production, contractual arrangements, farm survey*

## 1 INTRODUCTION

In recent years, the food supply chain has transformed significantly not just due to the global economic changes but also due to the social and demographic influences. The relations in the chains have become more complex, and increased concentration and changes in organization structure are characterized by the complex interactions with raising vertical coordination, usually gained through contracting in agricultural markets (Di Marcantonio, Ciaian & Castellanos, 2018a). The vertical coordination in the food supply chain has been relatively often discussed topic and involves the way in which the inputs are transferred into the form of products through the supply chain from producers to consumers. Well-known mechanisms for coordination of economic performance include vertical integration, contracting and markets. It is also worth to mention that the integration contains the coordination by means of the control of production and distribution stages and the other mechanisms include the coordination among the independent firms (Benmehaia & Brabez, 2018). Contracting is considered as the essential governance mechanism for the sector (Vavra, 2009) which might improve the efficiency, information, coordination and support closer linkages between farmers and specific buyers in the different level of the chain (MacDonald & Korb, 2011). Vertical integration based on the progressive process between the subjects on the market leads to the common coordination, better investment activities or innovations (Handfield & Nichols, 1999).

Significant structural changes in the food supply chain have led to the changing conditions in markets in the different sectors. Increasing market power of stronger parties on weaker ones has been shown as a serious problem, which together with other factors may lead to unfair trading practices (UTP) among businesses in the entire food supply chain. UTPs are practices that grossly differ from good commercial conduct and are contrary to good faith and fair dealing (European Commission, 2013). They were discussed for the first time at the European level in 2009 because the lack of transparency, anti-competitive activities and imbalances in the

bargaining power in the markets negatively influenced the competition and competitiveness of the food supply chain as a whole (Glöckner, 2017).

## **2 THEORETICAL BACKGROUND**

In recent years, the interest in the UTP area has increased significantly, particularly from parties directly influenced by these changes and policymakers (European Commission, 2013, 2014, 2018; European Parliament, 2016) what has brought the gradual effects in the legislative measures in the member states. In general, there exists a substantial lack of literature on unfair trading practices in the food supply chain (Sexton, 2017). Although the recent interest of policymakers and interested parties has caused an increasing number of studies dealing with the UTPs issues, the number of empirical literature is still insufficient, particularly in the farming sector. The problem occurs already at the definition of UTP because it does not often provide a sharp delineation of this term i.e. what should be called UTPs and what should not (Falkowski, 2017). Further problems arise at the setting of regulations and their slow implementation into practice.

Obtaining information appears to be another significant challenge. In a lot of cases, the source information is reported directly from suppliers or producers themselves – thus injured parties (Sexton, 2017) and according to Gorton, Lemke & Alfarsi (2017) one reason for the lack of evidence is the reluctance to report UTPs for fear of retaliation, so-called fear factor (Lee, 2017) or delisting by buyers. Commonly, for weaker parties it is difficult to take legal action against such practices, particularly because of concerns about the ending of business contracts. The absence of a clear legislative framework (until the specific legislation was established in the individual member states), the lack of incentives to use the court system as well as the fear factor have all contributed to the limited use of adjudication as an enforcement mechanism (Cafaggi & Iamiceli, 2018).

Contracting relations and agreements usually reflect the relationship between both business parties (Ahearn, 2002; Vavra, 2009; MacDonald & Korb, 2011). Similarly, the competitiveness of market actors is considered as the important element affecting the functioning of the food supply chain and fair competition. However, the unfair trading practices interfere the fair competition in the market. Delayed payments are one example of the practices that are considered as being unfair (Falkowski, 2017). They can provide more direct evidence of the impact of unfair commercial practices on farmers (Gow, Streeter & Swinnen, 2000) and are considered as one of the most crucial limitations for the growth of the companies. They negatively influence profits which may result in serious financing constraints (Rozelle & Swinnen, 2004), cash flows (Connell, 2014) and investments or farm production. Late payments and retroactive claims for payments not included in the contract are especially detrimental to micro and small enterprises (Veerman et al., 2016). Although the legal framework regulates the late payments, it provides relatively long payment period, that is not appropriate particularly for farmers producing perishable products.

Due to a rising vertical concentration in the food supply chain, particularly at the processing and retail sectors, a lot of attention has been paid to price monitoring, to mergers and organizations of processors and retailers in the agricultural market with focusing on fair competition among the economic subjects (Sexton et al., 2007). Lately, increased coordination has led to the problems of market power with a direct consequence of the imbalance in the bargaining power of the weaker parties. The economic literature (Bonanno, Russo & Menapace, 2018, Khemani & Shapiro, 1993) defines market power as the ability of a firm to set and maintain the price above or below the level that would prevail under perfect competition. It may put mainly producers at a disadvantage when bargaining over price and contractual

relations (Di Marcantonio et al., 2018a). Furthermore, it depresses the production (Bonanno et al., 2018) or creates a deadweight-loss in social welfare (Sexton & Zhang, 2001).

The imbalance in bargaining power does not necessarily mean market distortions but the limitation of weaker parties may evoke the violations of the principles of fair competition and this kind of an imbalance exists whenever one participant 'unilaterally governs the agreement'. Understanding of bargaining power as the ability to obtain the most favourable price or market conditions (directly or indirectly), each involved party must face all restrictions and effects (Fletcher et al., 1961). The direct consequences of these market-based restrictions can lead to unfair trading practices to the detriment of weaker market participants, in many cases small farmers and producers, or suppliers with very little bargaining power. Exercise of market power and imbalances in the bargaining power are perceived as the basic causes of unfair practices but authors (Renda et al., 2014; Falkowski, 2017; Di Marcantonio, Ciaian & Castellanos, 2018b) underline the subsequent factors like asymmetric information, costs of contract enforcement, switching costs, transaction costs, perishability of goods and seasonality of production as the other important factors behind UTPs.

One of the indirect (or partial) solutions to the issues of excessive market power and imbalanced bargaining power is the co-operation on a horizontal level, by setting up producer organizations (POs). The legislature of EU makes provision to recognize producer organizations across the majority of agricultural sectors. The initiative is a response to the imbalance in bargaining power between farmers and the concentrated processing and retail sector (Defra, 2014). Through POs, producers may also be expected to indirectly address some concerns linked to unfair practices (Falkovski, 2017). The cooperation should contribute to strengthening producers' relatively weaker position by allowing them to use economies of scale in producing and marketing their output (Menard, 2007), reduced costs, improved market reach and increased access to services or opportunities (Penrose & Buckley, 2007).

Over the last few years, a number of studies (i.e. Martin & Zering, 1997; Swinnen, 2005; Swinnen & Maertens, 2007; Dries et al., 2009; Fischer et al., 2009) have been carried out focusing on the relationships in the food supply chain. However, overall there has been only a few empirical evidence of unfair trading practices. The evidence of UTP effects is often indirect or based on the case studies. According to Falkovski (2017), the absence of such analyses could be caused by the following problems: i) definitions of UTP cover wide categories of practices and together with other factors affecting the individual situation, it is difficult to clearly delineate what UTP definition should and what should not include; ii) difficulties with measurement caused by imperfect available information. Data are usually provided by private firms and companies and because of the high sensibility of this kind of information, they are often not willing to reveal it. That is one of the reasons why market transparency is fundamental factor for an efficient functioning of the food supply chain (Copa Cogeca, 2016); iii) the presence of different market conditions and legal measures in a given country and time; iv) there still exists many unknown areas that have not been covered within UTPs and the current evidence doesn't provide the unambiguous results.

For the mentioned reasons, the attention has been focused on finding indirect evidence of distortions of competition or the presence of one unfair practices in vertical relationships of the chain. Past studies have revealed asymmetries in price transmission (Peltzman, 2000; Goodwin & Harper, 2000; Vavra & Goodwin, 2005; Lloyd et al., 2006; Bukeviciute et al. 2009; Rajcaniova & Pokrivcak, 2013), the problem with late payments (Gow et al. 2000; Connell 2014), market power (Sheldon & Sperling, 2003; Sexton, 2012; Perekhozhuk 2017), bargaining power (Battigalli, Fumagalli & Polo, 2007), the negative impact of reverse margin practices

(e.g. slotting fees) on the consumer (Rennhoff, 2004; Chambolle & Christin, 2016) or on the producer welfare (Shaffer, 2005).

One of the studies (Basic, 2015) dealing with unfair trading practices shows how growing market power and UTPs of EU supermarkets affect small producers of bananas and plantation workers. The authors emphasized that modern retailing is increasingly concentrated and during the collecting of evidence of UTPs, a 'fear factor' was apparently present. They found that prices and contracts were mostly negotiated on the short-term basis, but even the largest traders proved the imbalance of their bargaining power with retailers. Authors also found that a trend for longer-term contracts increases the commercial pressure from retailers. Importers make use of one-sided clauses containing withdraw from a contract if "his margin is insufficient". The risk is passed from buyer to exporters and producers, particularly smaller ones. Abad et al. (2012) conducted a survey to determine the extent and awareness of UTPs in the Philippines. The main conclusions from the survey results are that many respondents indicate that UTPs are moderate to highly widespread and unfair practices have unfavourable impacts on business transactions and consumer welfare. However, not many respondents are aware of the legal remedies against UTPs and if some firms were exposed to adverse influences of UTPs, they did not seek to take any action. In 2011, the survey by Dedicated Research on behalf Aim-Ciaa (2011) was carried out in 15 European Union countries and covered a sample of 684 suppliers. The surveyed firms were the brand producers only (48.4%), producers and retailers' brands (49.6%) and retailers brand only (2%) of mainly food and drink products (79.7%), non-food grocery (14.9%), or both (5.4%). The results showed that more than 96% of the surveyed organizations were ever exposed to unfair trading practices. In 84% cases, it was the factor of the non-respect of contractual terms by some customers, and then the second most common practice (77%) was delisting threats to obtain unjustified advantages or unilateral deductions from invoice payments without sound business reasons (63%). According to the survey, about 65% of the firms did not take any action after being exposed to the UTP and the survey also confirmed that UTPs have a negative impact on the costs, sales, and innovations of companies. The research on the economic impact of Unfair Trading Practices was provided by Copa-Cogeca (2013). The main purpose of this survey was to quantify the influence of UTPs in the agro-food sector in EU, so that the representing bodies could take the necessary actions against UTPs. The latest empirical evidence was provided by Di Marcantoni et al. (2018a), who conducted extensive research on unfair trading practices in the food supply chain within the dairy sector. This research was carried out in the four selected European regions i.e. France, Germany, Poland, Spain and is based on the 1248 observations. A total of 29 types of UTPs were identified. The occurrence of unfair practices was investigated in the contract content, contract negotiation and contract execution. A total of 93% of surveyed milk producers have reported at least one and 46% have reported at least three of UTPs.

There has been no evidence of the research of the presence of unfair trading practices in the dairy sector in Slovakia. Therefore, the purpose of this paper is to investigate the occurrence of UTPs among primary milk producers in Slovakia.

### **3 METHODOLOGY**

Since the contractual terms are often set by stronger parties of the business relationship, the research of UTPs is closely related to the investigation of contractual arrangements. This research was carried out among dairy producers in Slovakia through the questionnaire. Questions were focused on investigation of the contractual arrangements used in dairy sector and on investigation of the presence of UTPs in the contract content and in different phases of the contract development. Interviews were carried out face-to-face with 47 dairy producers in

Slovakia in the Nitra and Trnava region. The list of primary producers and buyers was obtained from the database of APA (Agricultural Paying Agency). According to this data, there were 115 dairy producers in both regions, representing almost 28% of the total number of dairy producers in Slovakia. Although we reached out to 83% of producers in selected regions, only 49% of them were willing to participate and to share information. A large number of contacted farmers who refused to participate, reported the fear as the main reason of rejection. The fieldwork lasted from May 2018 until January 2019. The questionnaire consisted of 60 questions (first seven questions were demographic questions), and was divided into three sections focused on dairy farm characteristics, characteristics of contractual relationships and UTP occurrence. Filling in the questionnaire took on average 45 – 60 minutes. The questionnaire covered two periods – year 2014 and 2017.

## 4 RESULTS

### 4.1 Farm characteristics

With a high number of farms still focused on raising of dairy cattle and production of cow's milk, The Nitra and Trnava region represent the area, where more than one quarter of all dairy producers in Slovakia operate. Interviews were carried out with farm managers and other persons at leading positions of selected farms. In the majority of cases, farm management was carried out by a man (93.6%). The common feature of all farms was cattle breeding for milk production as well as production of cereals. The size of farms and utilized land did not significantly change in the two reference periods. The average number of dairy cows of the sample farms was 350 and average size of total bovine herd was 800 animals. All details of sample size are summarized in Table 1

Tab. 1 – Basic characteristics of dairy farms. Source: own research

		Together	Nitra region	Trnava region
Sample size		47	19	28
	Gender			
	Man	93,6%		
	Woman	6,4%		
	Education			
	University	89,4%		
	High school	10,6%		
	Agricultural	83%		
	Non agricultural	17%		
		$\bar{X}$ ( $\bar{X}$ )	$\bar{X}$ ( $\bar{X}$ )	$\bar{X}$ ( $\bar{X}$ )
Farm area– 2017 (ha)		1973,3 (1771)	2389,3 (1686)	1691,0 (1415)
Number of other bovine animals - 2017 (pcs) (dairy cows, heifers, bulls, young heifers)		802 (567)	763 (683)	829 (496)
thereof number of dairy cows - 2017 (pcs)		355 (271)	318 (280)	377 (190)
Milk quota fulfillment 2014 - milk supply (%)		91,6	86,4	95,2

Dairy producers deliver their milk either directly to milk processing plants, traders or producer organizations. In 2017, the majority of milk production (84.2%) was delivered to milk processing plants, 10.6% of milk production was delivered to producer organizations and the smallest amount of milk production (0.8%) was sold directly on farms. 1.5% of milk production was used on own processing and own consumption accounted for 3.3% of production on average. Compared to 2014, the distribution of milk deliveries has changed. The deliveries to processing companies increased by 2.8%, however deliveries to producer organizations significantly decreased (by 6.1%).

## 4.2 Farmers' business and contractual relationship with the main milk buyer

Given the length of a business relationship, the number of years of "loyalty" in the sample of selected farms is characterized by high variability of contract length. If we assume that the length of long-term contract is more than 10 years, then in 2017, 36% of respondents reported the long-term cooperation with the same buyer. Another 17% of respondents cooperated with the same buyer for 5 years and almost one quarter of respondents (23.5%) cooperated with the same buyer for less than 5 years. Based on the respondents' answers, the most common causes of the latest change of main buyer included late payments for milk delivery (n=11), winding up of a milk processing plant or a producer organization (n=11) as well as own decision due to other reasons (n=12). Unfair and abusive behaviour of a milk processing plant, violation of contract conditions by buyer and different results of milk quality testing were among mainly cited other reasons.

We were also interested in potential obstacles perceived by dairy farmers in case they decided to change their main buyer (Figure 1). Almost half of the respondents said that the most important obstacle for them is the risk posed by cooperating with a new milk processing plant. Written contract was perceived as another main obstacle (28%) despite the fact that all dairy farmers have the notice period determined in the contract. 18.6% of farmers think that other buyers would not offer them as good conditions as their current buyer, therefore they are not considering the change.



Fig. 1 – Potential barriers to changing the main milk buyer. Source: own research

Because the majority of farmers are not considering the change of their buyer, we were also interested in the factors that farmers consider as the most important in the business relationship with their buyer. Almost 50% of respondents agreed that the price is the most important factor that contributes to strengthening and maintaining the business relationship. Other factors included payments for milk delivery on time, price stability and the constancy of milk collection.

Contractual agreements as an important part of a business relationship are currently widely discussed topic. During the interviews, dairy farmers, especially the small ones, very often claimed that their business relationships are quite complicated in terms of exercising their bargaining power. A written contract as a bilateral legal transaction regulates the relationship between business partners by setting the conditions under which producers (buyers) sell (buy) milk production. The better specification of provisions and contingencies in the contract reduces the likelihood of disputes occurrence and misunderstandings related to delivery terms.

Specific requirements should be negotiated and defined clearly at the beginning of the relationship. The survey results show that all contract terms were negotiated at the beginning of the relationship in written form. 77% of dairy producers had a contract directly with milk processing plant and the remaining 23% with producer organization.

Since the price is considered as the most important factor of the business relationship, we were interested in how the prices are established. In majority of cases (79%) the price is defined based on the situation in the market. 32% of farmers reported that the price is negotiated during the contract duration and 23% reported that price is imposed by buyer.

Bargaining power is also related to market position and power of a company. Each company has a certain level of bargaining power in relation to its buyer which can change over time. Farmers were asked if their bargaining power had changed compared to year 2014 (Figure 2). In case of a positive answer, we were also interested in the main causes which led to such a change. 60% of farmers reported that they had stronger bargaining power and they denoted the smaller number of dairy farms and thus the smaller milk production in the region and major changes in the farm as the main causes of this change.

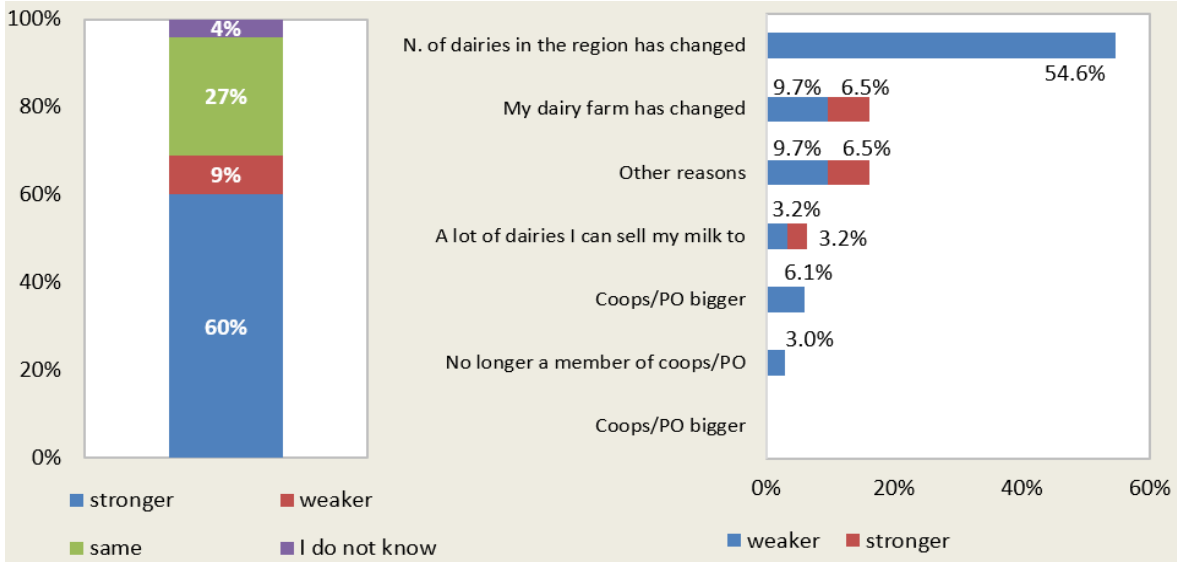

Fig. 2 – Bargaining power in relation to the main buyer and the reasons of change. Source: own research

Further, we investigated whether the contract terms changed over the duration of a contract. As the results show, during the reference period (2014-2017) changes in the contract terms or additional specification of some contract terms occurred in 13 cases. The changes were related to required quality (55%), adjustments of required quantity of milk delivery (9%) and other contract terms (36%) such as pricing, maturity of receivables or extra fees for milk delivery. Contract terms are negotiated by both parties and include parameters the business relationship is built on. Investigation of the number of elements of milk delivery arrangements explicitly included in the written contract, shows that of a total of 18 elements, on average 8 elements are explicitly specified in the contracts. Clearly defined contract duration and pricing were included in each contract. In case of more than 80% of farmers, their contracts included timing of payments (98%), milk quality testing (98%), defined milk quantity (92%) and terms for contract cancellation (89%).

**4.3 UTPs occurrence**

The next section of the questionnaire was centred on the investigating the presence of UTPs which may occur at different stages of the contract development. They might be included

directly in the contractual agreement, or they might occur at any time of duration of a contractual relationship, or even after termination of a contractual relationship.

The results of the survey show that the most frequently occurring UTP included in the contract content (Figure 3) is “no safeguard defined if the buyer fails to fulfil the contract” – reported by more than half of surveyed dairy farmers (55.3%). This UTP is the case when the contract does not include any protection clause that would somehow eliminate the buyers’ non-performance of the contract. The second most common UTP is unilateral price setting by the buyer (23.4%) – this practice reflects limited possibilities of dairy farmers to influence the price. Another common UTP reported by 17% of dairy farmers is “constraints for milk sale” – this practice limits farmer’s possibilities of selling milk to other processors/buyers, because farmer is usually committed to supply total production only to one buyer.

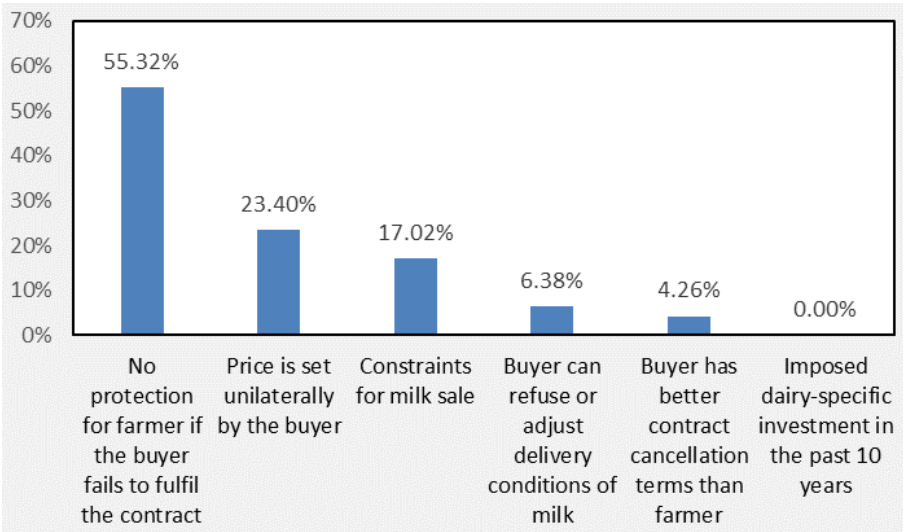

Fig. 3 – UTPs occurrence in the contract content. Source: own research

The most common UTPs encountered by farmers during contract execution (Figure 4) are “unilateral change in price imposed by the buyer” (21.3%) and “delays in payments for milk delivery” (10.6%). Farmers who reported the occurrence of delays in payments, were also asked about their reaction to this practice. 80% of them did not take any action, which can be attributed to 'fear factor' – some respondents even indicated it.

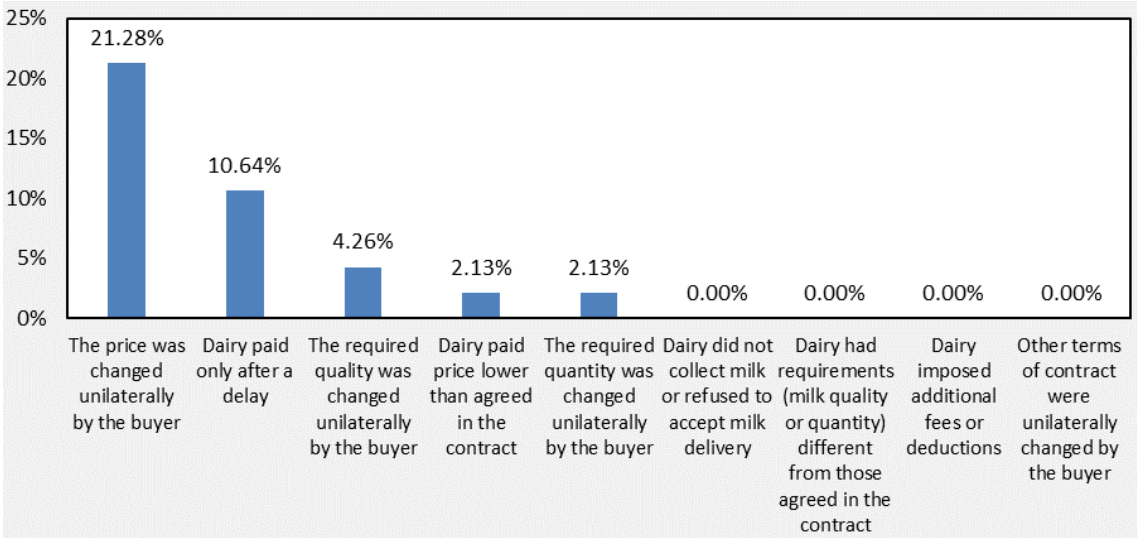

Fig. 4 – UTPs occurrence during contract execution. Source: own research



Unilateral ending of the contract by the buyer before expiration is the case of UTP related to contract finalization – the occurrence of this practice was confirmed by 19% of dairy farmers.

Table 2 shows total incidence of UTPs in the period under investigation at all three levels of business relationships in Nitra and Trnava region. The incidence of UTPs is very common – 87% of dairy respondents reported that in the considered period at least 1 UTP occurred during the contract execution with their main supplier. 49% of respondents confirmed at least 2 UTPs and 17% of respondents reported that they encountered at least 3 UTPs.

Tab. 2 – Occurrence of UTPs at dairy farms. Source: own research

At least 1 UTP	87.23%
At least 2 UTPs	48.94%
At least 3 UTPs	17.02%
At least 4 UTPs	6.38%
At least 5 UTPs	4.26%
At least 6 UTPs	2.13%

Table 3 compares the occurrence of UTPs between the group of dairy farmers who deliver their production to producer organization (PO) and the group of farmers who are not members of producer organization and deliver to other processors. There is no significant difference in UTPs occurrence between members and non-members of POs but the results show that the higher number of UTPs ( $n \geq 4$ ) occur in case of dairy farmers whose main buyers are processors. Those farmers who are members of PO did not encounter higher number of UTPs.

Tab. 3 – Occurrence of UTPs and farmers' membership of producer organizations. Source: own research

	<b>Members</b>	<b>Non-members</b>
At least 1 UTP	89%	89%
At least 2 UTPs	44%	51%
At least 3 UTPs	11%	19%
At least 4 UTPs	0%	8%
At least 5 UTPs	0%	5%
At least 6 UTPs	0%	3%

## 5 CONCLUSIONS

During the last twenty years, high fluctuation of prices of agricultural commodities has raised concerns about proper functioning of food supply chains, especially the dairy sector has attracted significant attention. In Slovakia, considerable differences in price developments at all levels of supply chain were partly caused by significant structural changes in the country, but they also reflected imbalances of market power among the agents in the supply chain. This kind of imbalances often leads to occurrence of unfair trading practices. Therefore, the main objective of the paper was to acquire complex information about dairy supply chain in Slovakia with focus on the problem of UTPs. Using the questionnaire, we decided to investigate the contractual arrangements and incidence of UTPs in the contract content and across different stages of contract development between milk producers and processors in Slovakia. We were also interested in the factors that farmers consider as the most important in the business relationship with their buyer. Almost 50% of respondents agreed that the price is the most important factor that contributes to strengthening and maintaining the business relationship. The survey showed that the price is also the most sensitive issue, which is reflected in frequent occurrence of UTPs related to price. The most common UTPs encountered by farmers during contract execution are “unilateral change in price imposed by the buyer” and “delays in payments for milk delivery”. In case of delayed payments 80% of farmers reported that they did not take any action partly due to fear factor as many of them indicated.

Overall, the results show that 87% of respondents reported at least 1 UTP in reference period and almost half of the respondents (49%) confirmed occurrence of at least 2 UTPs in relationship with their main buyer. Comparison of UTPs occurrence between farmers who are members of producer organizations and those who are not, showed very similar results, but members of producer organizations were not exposed to occurrence of higher number of UTPs (more than 4 UTPs).

This paper has contributed to empirical research of UTP issue which is still very limited. To the best of our knowledge there is no other research covering the issue of UTPs in Slovakia, especially in dairy sector which has faced many problems in recent years. Moreover, compared to other existing studies of UTPs, our paper deals with investigation of UTPs occurrence and thus provides a proof, whereas many studies in the past focused only on a few of selected aspects of contracts in agriculture mainly from theoretical point of view and not necessarily investigating the unfairness of practices. One line of research is focused on price formation process along the agri-food supply chain (Vavra & Goodwin, 2005; Lloyd et al., 2006) and analyses how the price movements are transmitted from farm to processors and retailers or in opposite direction. Thus, these studies refer to impact of market power which is the main concept in UTP but only in an indirect way. Another branch of research is focused on delayed payments which were reported also by farmers in our survey (Gorton & White, 2007). However, delayed payments are only one example of UTPs. We decided to employ a complex approach reflected in investigation of UTP at all stages of trade relationship. Furthermore, our findings are very similar to the results of survey carried out by Di Marcantonio et al. (2018a) who investigated UTPs occurrence in dairy sector in selected regions of France, Germany, Poland and Spain, which confirms that UTPs is issue in the whole EU. 98% of farmers in the survey by Di Marcantonio et al. (2018a) reported at least one UTP and 54% reported at least two UTPs. Because our sample size is small, the results cannot be generalized for the whole dairy sector, but it is still a proof that UTPs are present also in Slovakia. Results of Di Marcantonio et al. (2018a) confirming UTPs incidence in dairy sector in four another countries imply that UTPs in dairy sector is a serious issue that deserves the attention and solution at EU level in order to improve transparency of dairy supply chain.

## **Acknowledgments**

This paper was supported by the Slovak Research and Development Agency under the contracts No. APVV-15-0552 and No. APVV-16-0321.

## **References**

- Abad, A. R., Gonzales, K., Rosellon, M., & Yap, T. (2012). Unfair trade practices in the Philippines. *PIDS Discussion Paper*, 39, 1-57. Retrieved from <https://pidswebs.pids.gov.ph/CDN/PUBLICATIONS/pidsdps1239.pdf>
- Ahearn, M., Yee, J., & Huffman, W. (2002). *The effect of contracting and consolidation on farm productivity*. Paper presented at Economics of Contracting in Agriculture Workshop, Annapolis. Retrieved from [https://www.researchgate.net/publication/228698912\\_The\\_effect\\_of\\_contracting\\_and\\_consolidation\\_on\\_farm\\_productivity](https://www.researchgate.net/publication/228698912_The_effect_of_contracting_and_consolidation_on_farm_productivity)
- Basic (2015). *Banana value chains in Europe and the consequences of Unfair Trading Practices*. Retrieved from [http://www.makefruitfair.org/wp-content/uploads/2015/11/banana\\_value\\_chain\\_research\\_FINAL\\_WEB.pdf](http://www.makefruitfair.org/wp-content/uploads/2015/11/banana_value_chain_research_FINAL_WEB.pdf)

- Battigalli, P., Fumagalli, C., & Polo, M. (2007). Buyer power and quality improvements. *Research in Economics*, 61(2), 45-61. doi: 10.1016/j.rie.2007.02.002
- Benmehaia, M. A., & Brabez, F. (2018). Vertical Relationships and Food Supply Chain Coordination: The Case of Processing Tomato Sector in Algeria. *New Medit New: Mediterranean Journal of Economics, Agriculture and Environment*. 17(2), 3-14. doi: 10.30682/nm1802a
- Bonanno, A., Russo, C., & Menapace, L. (2018). Market power and bargaining in agrifood markets: A review of emerging topics and tools. *Agribusiness*, 34(1), 6-23. doi: 10.1002/agr.21542
- Bukeviciute, L., Dierx, A., Ilzkovitz, F., & Roty, G. (2009). *Price transmission along the food supply chain in the European Union*. Paper presented at 113th EAAE Seminar “A resilient European food industry and food chain in a challenging world”, Crete, Greece. doi: 10.22004/ag.econ.57987
- Cafaggi, F., & Iamiceli, P. (2018). *Unfair trading practices in the business-to-business retail supply chain: An overview on EU Member States legislation and enforcement mechanisms*. Luxembourg: European Commission. Retrieved from <http://publications.jrc.ec.europa.eu/repository/handle/JRC112654>
- Chambolle, C., & Christin, C. (2017). *New Product Introduction and Slotting Fees*. Ecole Polytechnique, Centre National de la Recherche Scientifique. Retrieved from <https://hal-polytechnique.archives-ouvertes.fr/hal-01458949/document>
- CIAA-AIM (2011). Unfair commercial practices in Europe. Dedicated research commissioned by CIAA and AIM. March 2011. Retrieved from <http://www.dlf.no/filestore/CIAAIMSurveyonUCP-Europe.pdf>
- Connell, W. (2014). Economic Impact of Late Payments. *Economic Papers*, 531, 1-22. Retrieved from [https://ec.europa.eu/economy\\_finance/publications/economic\\_paper/2014/pdf/ecp531\\_en.pdf](https://ec.europa.eu/economy_finance/publications/economic_paper/2014/pdf/ecp531_en.pdf)
- Copa-Cogeca (2013). *Copa-Cogeca contribution to the public consultation on the Green Paper on unfair trading practices (UTPs) in business to business (B2B) relations in the food and non-food supply chain*. Retrieved from [http://ec.europa.eu/internal\\_market/consultations/2013/unfair-trading-practices/docs/contributions/registered-org/copa-cogeca\\_en.pdf](http://ec.europa.eu/internal_market/consultations/2013/unfair-trading-practices/docs/contributions/registered-org/copa-cogeca_en.pdf)
- Copa-Cogeca. (2016). *Contribution from Copa and Cogeca to the Agricultural Markets Task Force*. Retrieved from [https://ec.europa.eu/agriculture/sites/agriculture/files/agri-markets-task-force/contributions/2016-05-24/copacogeca1\\_en.pdf](https://ec.europa.eu/agriculture/sites/agriculture/files/agri-markets-task-force/contributions/2016-05-24/copacogeca1_en.pdf)
- Defra. (2014). *Conditions, Attitudes and Structures of Successful POs and Cooperatives: potential role in supporting a competitive farming sector in England and Wales*. Retrieved from [https://ec.europa.eu/agriculture/sites/agriculture/files/agri-markets-task-force/contributions/2016-05-24/ukdefracoop\\_en.pdf](https://ec.europa.eu/agriculture/sites/agriculture/files/agri-markets-task-force/contributions/2016-05-24/ukdefracoop_en.pdf)
- Di Marcantonio, F., Ciaian, P., & Castellanos, V. (2018a). Unfair trading practices in the dairy farm sector: Evidence from selected EU regions. Retrieved from <http://publications.jrc.ec.europa.eu/repository/handle/JRC112770>
- Di Marcantonio, F., Ciaian, P., & Castellanos, V., (2018b). *Unfair trading practices in the dairy farm sector: Insights from an EU field survey*. Paper presented at 30<sup>th</sup> International Conference of Agricultural Economists, Vancouver. doi: 10.22004/ag.econ.275886

- Dries, L., Germenji, E., Noev, N., & Swinnen, J. F. (2009). Farmers, vertical coordination, and the restructuring of dairy supply chains in Central and Eastern Europe. *World development*, 37(11), 1742-1758. doi: 10.1016/j.worlddev.2008.08.029
- European Commission. (2013). *Green Paper on Unfair Trading Practices in the Business-to-business Food and Non-food Supply Chain in Europe*. Luxembourg: European Commission. Retrieved from <http://eur-lex.europa.eu/legal-content/EN/ALL/?uri=CELEX%3A52013DC0037>
- European Commission (2014). *Tackling unfair trading practices in the business-to-business food supply chain. Communication from the Commission to the European Parliament, the Council, the European Economic and Social Committee and the Committee of the Regions*. Luxembourg: European Commission. Retrieved from [www.ec.europa.eu/internal\\_market/retail/docs/140715-communication\\_en.pdf](http://www.ec.europa.eu/internal_market/retail/docs/140715-communication_en.pdf)
- European Commission (2018). *Initiative to improve the food supply chain (unfair trading practices)*. Luxembourg: European Commission. Retrieved from <https://eur-lex.europa.eu/legal-content/EN/TXT/PDF/?uri=CELEX:52018SC0092&from=EN>
- European Parliament. (2016). *European Parliament resolution on unfair trading practices in the food supply chain*. Luxembourg: European Commission. Retrieved from <http://www.europarl.europa.eu/sides/getDoc.do?type=TA&language=EN&reference=P8-TA-2016-0250>
- Fałkowski, J. (2017). The economic aspects of unfair trading practices: measurement and indicators. In F. Di Marcantonio & P. Ciaian (Eds), *Unfair trading practices in the food supply chain: A literature review on methodologies, impacts and regulatory aspects*. Luxembourg: European Commission, 20-38. Retrieved from [https://publications.jrc.ec.europa.eu/repository/bitstream/JRC108394/jrc\\_report\\_utps\\_final.pdf](https://publications.jrc.ec.europa.eu/repository/bitstream/JRC108394/jrc_report_utps_final.pdf)
- Fischer, C., Hartmann, M., Reynolds, N., Leat, P., Revoredo-Giha, C., Henschion, M., & Gracia, A. (2009). Factors influencing contractual choice and sustainable relationships in European agri-food supply chains. *European Review of Agricultural Economics*, 36(4), 541-569. doi: 10.1093/erae/jbp041
- Fletcher, L. B., Paulsen, A., Kaldor, D. R., Stucky, W. G., Talbot, R. B., Davey, H. W., Hines, H. H., Kolmer, L. R., Kutish, F. A., Strain, J. R., Scott, J. T., Rackham, T. S., & Nordin, J. A. (1961). Bargaining power in agriculture. *CARD Reports*, 14. Retrieved from [https://lib.dr.iastate.edu/card\\_reports/14/](https://lib.dr.iastate.edu/card_reports/14/)
- Goodwin, B. K., & Harper, D. C. (2000). Price transmission, threshold behaviour, and asymmetric adjustment in the US pork sector. *Journal of Agricultural and Applied Economics*, 32(3), 543-553. doi: 10.1017/S1074070800020630
- Glöckner, J. (2017). Unfair trading practices in the supply chain and the co-ordination of European contract, competition and unfair competition law in their reaction to disparities in bargaining power. *Journal of Intellectual Property Law & Practice*, 12(5), 416-434. doi: 10.1093/jiplp/jpx035
- Gorton, M., Lemke, F., & Alfarsi, F. (2017). *Methodological Framework: Review of Approaches Applied in the Literature to Analyse the Occurrence and Impact of UTPs*. Paper presented at 'Unfair Trading Practices in the Food Supply Chain', Brussels 17-18.

- Gow, H. R., Streeter, D. H., & Swinnen, J. F. (2000). How private contract enforcement mechanisms can succeed where public institutions. *Agricultural economics*, 23(3), 253-265. doi: 10.1016/S0169-5150(00)00087-6
- Handfield, R. B., & Nichols, E. L. (1999). *Introduction to supply chain management*. New Jersey: Prentice – Hall.
- Khemani, R. S., & Shapiro, D. M. (1993). *Glossary of Industrial Organisation Economics and Competition Law*. Paris: Organisation for Economic Co-operation and Development. Retrieved from <https://www.oecd.org/competition/abuse/2376087.pdf>
- Lee, S. (2017). *The Possibility of the Introduction of Business-to-Business Unfair Trading Practices Regulation in EU Law*. Budapest: Eötvös Loránd University. Retrieved from <https://ssrn.com/abstract=2985377>
- Lloyd, T. A., McCorrison, S., Morgan, C. W., & Rayner, A. J. (2006). Food scares, market power and price transmission: the UK BSE crisis. *European Review of Agricultural Economics*, 33(2), 119-147. doi: 10.1093/erae/jbl001
- MacDonald, J. M., & Korb, P. (2011). Agricultural contracting update: Contracts in 2008. *Economic Information Bulletin*, 72. Washington: United States Department of Agriculture. Retrieved from [https://www.ers.usda.gov/webdocs/publications/44524/5874\\_eib72.pdf?v=0](https://www.ers.usda.gov/webdocs/publications/44524/5874_eib72.pdf?v=0)
- Martin, L. L., & Zering, K. D. (1997). Relationships between industrialized agriculture and environmental consequences: The case of vertical coordination in broilers and hogs. *Journal of Agricultural and Applied Economics*, 29(1), 45-56. doi: 10.1017/S1074070800007537
- Ménard, C. (2007). Cooperatives: hierarchies or hybrids? In K. Karantininis & J. Nilsson (Eds.), *Vertical Markets and Cooperative Hierarchies*. Netherlands: Springer. Retrieved from [https://www.researchgate.net/publication/225231064\\_Cooperatives\\_Hierarchies\\_or\\_Hybrids](https://www.researchgate.net/publication/225231064_Cooperatives_Hierarchies_or_Hybrids)
- Peltzman, S. (2000). Prices rise faster than they fall. *Journal of Political Economy*, 108(3), 466-502. doi: 10.1086/262126
- Penrose-Buckley, C. (2007). *Producer organisations: A guide to developing collective rural enterprises*. Oxford: Oxfam.
- Perekhozhuk, O., Glauben, T., Grings, M., & Teuber, R. (2017). Approaches and methods for the econometric analysis of market power: a survey and empirical comparison. *Journal of Economic Surveys*, 31(1), 303-325. doi:10.1111/joes.12141
- Rajcaniova, M., & Pokrivcak, J. (2013). Asymmetry in price transmission mechanism: the case of Slovak potato market. *Review of agricultural and applied economics*, 16(2), 16-23. doi: 10.22004/ag.econ.158092
- Renda, A., Cafaggi, F., Pelkmans, J., Iamicelli, P., Correia de Brito, A., Mustilli, F., & Bebber, L. (2014). Study on the Legal Framework Covering Business-to-business Unfair Trading Practices in the Retail Supply Chain. Luxembourg: European Commission. Retrieved from [http://www.academia.edu/download/44629491/140711-study-utp-legal-framework\\_en.pdf](http://www.academia.edu/download/44629491/140711-study-utp-legal-framework_en.pdf)
- Rennhoff, A. (2008). Paying for shelf space: An investigation of merchandising allowances in the grocery industry. *Journal of Agricultural & Food Industrial Organization*, 6(1), 9. doi: 10.2202/1542-0485.1233

- Rozelle, S., & Swinnen, J. F. (2004). Success and failure of reform: Insights from the transition of agriculture. *Journal of economic literature*, 42(2), 404-456. doi: 10.1257/0022051041409048
- Sexton, R. J. (2017). *Unfair trade practices in the food supply chain: defining the problem and the policy issues*. Luxembourg: European Commission.
- Sexton, R. J. (2012). Market power, misconceptions, and modern agricultural markets. *American Journal of Agricultural Economics*, 95(2), 209-219. doi: 10.1093/ajae/aas102
- Sexton, R. J., Sheldon, I., McCorriston, S., & Wang, H. (2007). Agricultural trade liberalization and economic development: the role of downstream market power. *Agricultural Economics*, 36(2), 253-270. doi: 10.1111/j.1574-0862.2007.00203.x
- Sexton, R. J., & Zhang, M. (2001). An assessment of the impact of food industry market power on US consumers. *Agribusiness*, 17(1), 59-79. doi: 10.1002/1520-6297(200124)17:1<59::AID-AGR1003>3.0.CO;2-D
- Shaffer, G. (2005). Slotting allowances and optimal product variety. *The BE Journal of Economic Analysis & Policy*, 5(1). doi: 10.1515/1538-0637.1083
- Sheldon, I., & Sperling, R. (2003). Estimating the Extent of Imperfect Competition in the Food Industry: What have we learned? *Journal of Agricultural Economics*, 54(1), 89-109. doi: 10.1111/j.1477-9552.2003.tb00052.x
- Swinnen, J. F. (2005). The Dynamics of Vertical Coordination in Agrifood Chains in Eastern Europe and Centra Asia. *ECSSD Case studies working paper*, 41. Washington: World Bank. Retrieved from <http://documents.worldbank.org/curated/en/421071468749080930/The-dynamics-of-vertical-coordination-in-agrifood-chains-in-Eastern-Europe-and-Centra-Asia>
- Swinnen, J. F., & Maertens, M. (2007). Globalization, privatization, and vertical coordination in food value chains in developing and transition countries. *Agricultural economics*, 37, 89-102. doi: 10.1111/j.1574-0862.2007.00237.x
- Vavra, P. (2009). Role, usage and motivation for contracting in agriculture. *OECD Food, Agriculture and Fisheries Papers*, 16, 1-36. doi: 10.1787/225036745705
- Vavra, P., & Goodwin, B. K. (2005). Analysis of Price Transmission along the Food Chain. *OECD Food, Agriculture and Fisheries Working Papers*, 3, 1-58. doi: 10.1787/752335872456
- Veerman, C. P., Cabrero, E. V., Babuchowski, A., Fresco, L. O., Giesen, H., Iwarson, T., & Juhász, A. (2016). *Improving market outcomes: enhancing the position of farmers in the supply chain*. Luxembourg: European Commission. Retrieved from [https://ec.europa.eu/agriculture/sites/agriculture/files/agri-markets-task-force/improving-markets-outcomes\\_en.pdf](https://ec.europa.eu/agriculture/sites/agriculture/files/agri-markets-task-force/improving-markets-outcomes_en.pdf)

## Contact information

### Ing. Katarína Baráthová

Slovak University of Agriculture, Faculty of Economics and Management

Tr. Andreja Hlinku 2, 94976, Nitra, Slovak Republic

E-mail: xbarathovak@uniag.sk

ORCID: 0000-0003-1785-2827

**Ing. Lucia Vargová, PhD.**

Slovak University of Agriculture, Faculty of Economics and Management

Tr. Andreja Hlinku 2, 94976, Nitra, Slovak Republic

E-mail: xvargoval@uniag.sk

ORCID: 0000-0003-1880-2151

**Ing. Martin Jamrich, PhD.**

Slovak University of Agriculture, Faculty of Economics and Management

Tr. Andreja Hlinku 2, 94976, Nitra, Slovak Republic

E-mail: xjamrichm1@uniag.sk

ORCID: 0000-0001-7072-4213

doi: 10.7441/dokbat.2019.006

# MARKET-BASED PERFORMANCE MEASURES: A SHAREHOLDER'S PERSPECTIVE

*Abu Bawa*

## **Abstract**

The concept of performance measurement is an important construct in management and strategic management literature. It is a hotly debated topic and a favourite theme in management research. Since performance measurement is a multi-dimensional construct, there is no consensus as to the choice of independent variable in measuring performance. This article contributes to this debate by presenting the two most popular measures, Price-to-Earnings ratio and the Market-to-Book value, commonly considered as market-based performance measures of profitability from the viewpoint of shareholders. Profitability measures are used as indicators of business financial performance in a multi-dimensional performance model. To assess the financial aspect of firm's performance, researchers generally used either accounting-based or market-based measures. The accounting-based measures are considered back-ward looking and are influenced by accounting standards and management choice of accounting methods. Market-based measures are forward looking and mostly favoured by shareholders. The underlying assumption of the market-based measures is market efficiency, which views stock price as representing the firm's fundamental value. Market based performance measures incorporates all relevant information and thus not limited to only a single aspect of performance unlike the accounting measures. The theoretical basis for using market-based performance measures is that they reflect a firm's financial performance more accurately compared to the accounting-based measures.

*Keywords:* performance measures, financial performance, shareholder, strategic management

## **1 INTRODUCTION**

Financial performance is widely believed to represent the fulfilment of the economic goals of the firm. In a multi-dimensional representation of organizational effectiveness, Venkatraman and Ramanujan (1986) used three concentric overlapping circles to explain the inter-relationship between Organizational effectiveness, Business performance and Financial performance. The inner circle represents financial performance, which is assumed to fulfil the economic goals of the firm. The most commonly used indicators to measure financial performance are sales growth, profitability measures, earnings per share, market-to-book, stock market returns and Tobin's Q (Hax & Majluf, 1984; Kudla, 1980; Montgomery & Singh, 1984; Lindenberg & Ross, 1981; Venkatraman & Ramanujam, 1986). The medium circle, which is referred to as the business performance, is made up of both operational performance and the financial performance. The operational performance is non-financial in nature. None-financial indicators include market share, product quality, new product introduction etc. Organizational effectiveness, which is represented by the outermost circle, extends the business performance to include organizational goals and influence of multiple stakeholders.

Business performance and its measurement continue to challenge researchers because of its complexity and diverse approaches used by researchers. The use of stakeholder satisfaction approach in measuring business performance has been adopted in earlier works (Clarkson, 1995; Kaplan & Norton, 1992; Richard et al., 2009; Venkatraman & Ramanujan, 1986)



Stakeholders according to Freeman (1984) are “any group or individual who can effect or is affected by the achievement of the organization’s objectives” (Santos & Brito, 2002). This definition gives rise to a lot of unmanageable stakeholders. Many scholars (Clarkson, 1995; Donaldson & Preston, 1995; Mitchell, Agle & Wood, 1997) offered different methods of identifying and selecting stakeholders. This paper adopts the method taken by Santos and Brito (2002). Stakeholders identified in the annual reports of selected companies are shareholders, customers, employees, government and society.

The aim of this paper is to contribute to this effort by looking at available market-based indicators frequently used in annual reports to measure financial performance of a business from the viewpoint of shareholders.

**2 DIMENSIONS OF PERFORMANCE MEASUREMENT**

The indicators used to measure different aspects of business performance has been found to be multidimensional (Baum & Wally, 2003; Cho & Pucik, 2005; Combs, Crook & Shook, 2005; Johnson & Greening, 1999; Rowe & Morrow, 1999; Sila & Ebrahimipour, 2005; Silverman, Nickerson & Freeman, 1997).

Using the Venkatraman and Ramanujan’s (1986) conceptual model in which performance has two-second order dimensions: Financial, represented by profitability, growth and market value; and the operational domain that includes the nonfinancial operational measures like customer satisfaction, quality, employee satisfaction, and innovation. The model can be depicted as follows as in Figure 1.

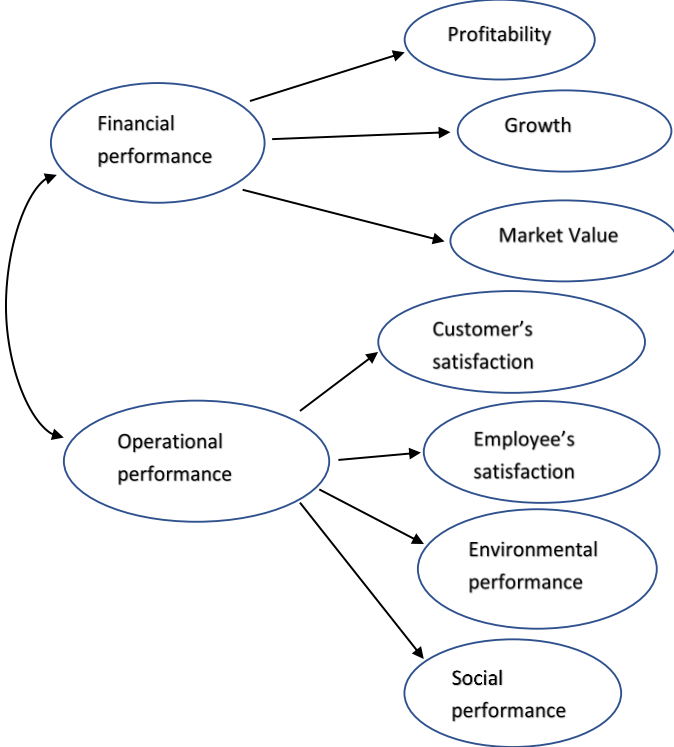

Fig. 1 – Multidimensional performance measurement. Source: Venkatraman & Ramanujan (1986)

The profit dimension is the most widely used measure of firm’s performance because it assesses the fulfilment of the economic goal of the firm. The two main approaches used by researchers to measure the profitability dimension can be broadly classified as Accounting based measures and Market based measures.

The accounting measures are generally considered to be effective measures of firm's profitability. These measures are ROE, ROA, ROS, PM, ROI etc. Accounting based profit measures are criticised for being back-ward looking. Profit as an accounting measured is influenced by accounting standards and choice of accounting methods of assessing tangible and intangible assets (Kapopoulos & Lazaretou, 2007).

### 3 MARKET BASED PERFORMANCE MEASURES

Market based performance measures are characterised by their forward-looking aspects and reflects expectations of shareholders concerning future performance of the company (Wahla, Shah & Hussain, 2012; Shan & McIver, 2011; Ganguli & Agrawal, 2009).

Hence, market measures focus on the stock market's evaluation of the firm's performance. The most commonly used performance measures are stock price and earnings per share, hence the P/E ratio, and Market-to-Book Value (Thune & House, 1970; Rumelt, 1974; Kudla, 1980; Bourgeois, 1980; Hofer, 1980)

The underlying assumption of the market measures is based on market efficiency, which views stock price as representing the firm's fundamental value. Market based performance measures incorporates all relevant information and thus not limited to only a single aspect of performance unlike the accounting measures (Lubatkin & Shrieves, 1986). The theoretical basis for using market-based performance measures is that they reflect a firm's financial performance more accurately compared to the accounting-based measures. Market-based measures are different from the accounting-based measures because they focus on the present value of future inflow of income, whereas accounting-based measures focus on past performance (Seth, 1990). Furthermore, market measures are immune to the deceptive managerial practices or accounting conventions under the assumptions that the efficient market can see through such distortions (Rowe & Morrow, 1999)

However, Hoskisson, Johnson and Moesel (1994) and Jacobsen (1988), suggested that past performance represented by accounting measures are good predictors of future performance measured by the market-based measures. They found a significant positive relationship between accounting-based measures and market-based measures of financial performance. Therefore, empirically, the two measures appear to be quite similar, hence separate dimensions of a single underlying construct of firm financial performance.

#### 3.1 Price-to-Earnings (P/E) ratio

The p/E ratio is the measure of the market confidence in the earning potential of the firm. This ratio is reported in almost all annual reports of quoted companies. The ratio is calculated as P/E ratio = Market price per share/Earnings per share. Alternatively, if the required data is not available, then using Gordon Growth Dividend Discount Model, PE ratio can be calculated as (Fun & Basana, 2012):

$$\frac{P_0}{E_0} = \frac{D_0/E_0 \times (1 + g)}{E_0 - r} \quad (1)$$

Where  $D_0/E_0$  is the dividend payout ratio,  $g$  is expected constant dividend growth rate, and  $r$  is the stock's required rate of return. From this equation, it is evident that dividend payout ratio and expected growth rate have positive relationship with P/E ratio while stock's rate of return is inversely related. It is the expectation that the higher the ratio is then the better is the market expectations of the earning potential, hence future profitability. The p/E ratio is very efficient and practical. Investors and analyst have long been using the p/E ratio to help determined if individual stocks are reasonable priced. There are some measurement issues in measuring the

p/E ratio. The first issue is related to the time frame. The price in the P/E ratio is usually the current market price, such as a weekly average, or daily closing price. However, the earnings used is usually the realized earnings from the past year or average of annual earnings for the past few years or forecasted earnings for the future (Shen, 2000). Hence trailing P/E ratio and forward P/E ratio. The forward P/E ratio, which divides stock price by forecasted earnings, is less affected by nonrecurring earnings. In the literature, it is demonstrated that forward-looking earnings are more valuable than historical earnings (Dechow, Hutton & Sloan; 1999, Kim & Ritter, 1999; Wu, 2014). There exists therefore evidence that the forward P/E ratio explains stock prices better than the historically based financial ratios. Wu (2014) found out that forward P/E ratio predicts future earnings growth better than trailing P/E ratio.

The relationship between P/E ratio and profitability was first demonstrated by Ohlson and Gao (2006). They used a theoretical model to predict the relation between P/E ratio and return on equity. This relation was empirically demonstrated by Wu (2014). Results showed that the P/E ratio has a U-shaped relation with the return on equity. Firms with higher forward P/E ratios achieve lower ROE in the subsequent years and the distribution of their earnings is more volatile and wide spread than firms with lower P/E ratio (Wu, 2014). Firms with high P/E ratio report higher earnings. Furthermore, using GSCORE, Wu (2014) found out that among high P/E ratio, firms with higher GSCORE report higher earnings growth, sales growth, and ROE in subsequent years.

### 3.2 Market-to-book ratio (MB)

The MB measure is a very good measure of performance because it show the premium or confidence that market places on the firm and therefore reflects the efficiency with which the market views the firm as being managed (Sharma et al., 2013). High premium implies high return for each dollar invested compared to low premium ratio.

The use of the MB ratio as a measure of performance increased significantly in the literature since the mid-1980s (Cho & Pucik, 2005; Dushnitsky & Lenox, 2006; Tanriverdi & Venkatraman, 2005; Sharma et al., 2013). Since the MB uses both accounting and market value indicators of firm performance, it provides a theoretical rationale as a measure of firm performance (Lee & Makhija, 2009; Sharma et al., 2013; Ceccagnoli, 2009). Usually, earnings manipulations and errors, when present, occur in the income statement and affects earnings-based accounting measures of performance (Fisher & McGowan, 1983; Amit & Wernerfelt, 1990). However, a Balance Sheet variable as Book value, is a commulative value and less susceptible to manipulations. The Book Value, as a commulative value, is relatively stable compared to the annual earnings and cash flows. The theoretical rational can be demonstrated as follows using the steady state constant growth dividend discount model (Sharma et al., 2013):

$$M = \frac{D * (1 + g)}{(r - g)} \quad (2)$$

Where;

M = Market Value of Equity

D = Cash Dividends at the beginning of the year

G = growth rate

R = required rate of return

Since the dividend paid can be re-written as payout ratio of earnings, the above equation transforms to:

$$M = \frac{e * PO * (1 + g)}{(r - g)} \quad (3)$$

Where

e = Total Net earnings

PO = Payout ratio (Cash dividend/Total net earnings)

If all earnings are dividends, whether paid out or retained, and dividing both sides of the equation by book Value (B), we get:

$$\frac{M}{B} = \frac{ROE * (1 + g)}{(r - g)} \quad (4)$$

Thus, theoretically, the Market -to-Book ratio incorporates both performance and risk measures. As shown above in the equation, M/B ratio is a positive function of performance as indicated by the Return on Equity (ROE) and growth (g) and a positive function of the dividend payout ratio. Understand how much control management has over the independent variables is very important for strategic management. Therefore, management action can have more impact on efficiency and growth which in turn impacts firm's performance.

#### 4 CONCLUSION

The concept of performance measurement in management and strategic management theory is hotly debated in the literature, unfortunately no one single measure of performance can portray this all-important concept. This article contributes to this debate by presenting the two most popular measures, Price-to-Earnings ratio and the Market-to-Book value, commonly considered as market-based performance measures of profitability from the viewpoint of shareholders. Profitability measures are mostly used as indicators of business financial performance in a multi-dimensional performance model. To assess the financial aspect of firm's performance, researchers generally used either accounting-based or market-based measures. The limitation here is that only the two measures of financial aspect of firm's performance are presented, other market-based measures were not considered, mainly because these two measures are mostly used in annual reports.

#### References

- Amit, R., & Wernerfelt, B. (1990). Why Do Firms Reduce Business Risk? *Academy of Management Journal*, 33(3), 520-533. doi: 10.2307/256579
- Baum, R. J., & Wally, S. (2003). Strategic Decision Speed and Firm Performance. *Strategic Management Journal*, 24(11), 1107-1129. doi: 10.1002/smj.343
- Bourgeois, L. J. (1980). Performance and consensus. *Strategic Management Journal*, 1(3), 227-248. doi: 10.1002/smj.4250010304
- Ceccagnoli, M. (2009). Appropriability, Preemption, and Firm Performance. *Strategic Management Journal*, 30(1), 81-98. doi: 10.1002/smj.723
- Cho, H., & Pucik, V. (2005). Relationship between Innovativeness, Quality, Growth, Profitability and Market Value. *Strategic Management Journal*, 26(6), 555-575. doi: 10.1002/smj.461

- Clarkson, M. B. (1995). A Stakeholder Framework for Analyzing and Evaluating Corporate Social Performance. *Academy of Management Review*, 20(1), 92-117. doi: 10.2307/258888
- Combs, J. B., Crook, R. T., & Shook, C. L. (2005). The Dimensionality of Organizational Performance and its Implications for Strategic Management Research. In D. Ketchen & D. Bergh (Eds.), *Research Methodology in Strategy and Management*. Bingley: Emerald. doi: 10.1016/S1479-8387(05)02011-4
- Dechow, P. M., Hutton, A. P., & Sloan, R. G. (1999). An empirical assessment of the residual income valuation model. *Journal of Accounting and Economics*, 26(1-3), 1-34. doi: 10.1016/S0165-4101(98)00049-4
- Donaldson, T., & Preston, L. E. (1995). The Stakeholder Theory of the Corporation: Concepts, Evidence, and Implications. *Academy of Management Review*, 20(1), 65-91, doi: 10.5465/AMR.1995.9503271992
- Dushnitsky, G., & Lenox, M. J. (2006). When does corporate venture capital investment create firm value? *Journal of Business Venturing*, 21(6), 753-772. doi: 10.1016/j.jbusvent.2005.04.012
- Fisher, F. M., McGowan, J. J. (1983). On the Misuse of Accounting Rates of Return to Infer Monopoly Profits. *American Economic Review*, 73(1), 82-97. Retrieved from <https://www.jstor.org/stable/1803928>
- Freeman, R. E. (1984). *Strategic Management: A Stakeholder Approach*. Cambridge: Cambridge University Press.
- Fun, L. P., & Basana, S. R. (2012). Price Earnings Ratio and Stock Return Analysis. (Evidence from Liquidity 45 Stocks Listed in Indonesia Stock Exchange). *Jurnal Manajemen Dan Kewirausahaan*, 14(1), 7-12. doi: 10.9744/jmk.14.1.7-12
- Ganguli, S. K., & Agrawal, S. (2009). Ownership structure and firm performance: An empirical study on listed Mid-Cap Indian Companies. *IUP Journal of Applied Finance*, 15(12), 37-52. Retrieved from <https://ssrn.com/abstract=1523669>
- Hax, A. C., & Majluf, N. S. (1984). The Corporate Strategic Planning Process. *Interfaces*, 14(1), 47-60. doi: 10.1287/inte.14.1.47
- Hofer, C. W. (1980). Turnaround Strategies. *Journal of Business Strategy*, 1(1), 19-31. doi: 10.1108/eb038886
- Hoskisson, R. E., Johnson, R. A., & Moesel, D. D. (1994). Corporate Divestiture Intensity in Restructuring Firms: Effects of Governance, Strategy, and Performance. *Academy of Management Journal*, 37(5), 1207-1251. doi: 10.2307/256671
- Jacobsen, R. (1988). The persistence of Abnormal returns. *Strategic Management Journal*, 9(5), 415-430. doi: 10.1002/smj.4250090503
- Johnson, R. A., & Greening, D. W. (1999). The Effects of Corporate Governance and Institutional Ownership Types on Corporate Social Performance. *Academy of Management Journal*, 42(5), 564-577. doi: 10.5465/256977
- Kaplan, R. S., & Norton, D. P. (1992). The Balanced Scorecard—Measures that Drive Performance. *Harvard Business Review No. 92105*. Retrieved from [https://www.academia.edu/1180984/The\\_balanced\\_scorecard\\_measures\\_that\\_drive\\_performance](https://www.academia.edu/1180984/The_balanced_scorecard_measures_that_drive_performance)

- Kapopoulos, P., & Lazaretou, S. (2007). Corporate Ownership Structure and Firm Performance: evidence from Greek firms. *Corporate Governance: An international Review*, 15(2), 144-158. doi: 10.1111/j.1467-8683.2007.00551.x
- Kim, M., & Ritter, J. R. (1999). Valuing IPOs. *Journal of Financial Economics*, 53(3), 409-437. doi: 10.1016/S0304-405X(99)00027-6
- Kudla, R. J. (1980). Some Pitfalls in Using Certainty-Equivalents: A Note. *Journal of Business Finance and Accounting*, 7(2), 239-243. doi: 10.1111/j.1468-5957.1980.tb00740.x
- Lee, S. H., & Makhija, M. (2009). Flexibility in Internationalization: Is It Valuable During an Economic Crisis? *Strategic Management Journal*, 30(5), 537-555. doi: 10.1002/smj.742
- Lindenberg, E. B., & Ross, S. (1981). Tobin's q Ratio and Industrial Organization. *Journal of Business*, 54(1), 1-32. doi: 10.1086/296120
- Lubatkin, M., & Shrieves, R. E. (1986). Towards Reconciliation of Market Performance Measures to Strategic Management Research. *Academy of Management Review*, 11(3), 497-512. doi: 10.5465/AMR.1986.4306197
- Mitchell, R. K., Agle, B. R., & Wood, D. J. (1997). Toward a Theory of Stakeholder Identification and Salience: Defining the Principle of Who and What Really Counts. *Academy of Management Review*, 22(4), 853-886. doi: 10.5465/amr.1997.9711022105
- Montgomery, C. A., & Singh, H. (1984). Diversification strategy and systematic risk. *Strategic Management Journal*, 5(2), 181-191. doi: 10.1002/smj.4250050208
- Ohlson, J., & Gao, Z. (2006). Earnings, Earnings Growth and Value. *Foundations and Trends in Accounting*, 1(1), 1-70. doi: 10.1561/14000000001
- Richard, P. J., Devinney, T. M., Yip, G. S., & Johnson, G. (2009). Measuring Organizational Performance: Towards Methodological Best Practice. *Journal of Management*, 35(3), 718-804. doi: 10.1177/0149206308330560
- Rowe, W. G., & Morrow, J. L. (1999). A note on the dimensionality of the firm financial performance construct using accounting, market, and subjective measures. *Revue Canadienne des Sciences de l'Administration*, 16(1), 58-71. doi: 10.1111/j.1936-4490.1999.tb00188.x
- Rumelt, R. P. (1974). *Strategy, structure and economic performance*. Cambridge: Harvard University Press.
- Santos, B. J., & Brito, A. L. (2012). Toward a Subjective Measurement Model for Firm Performance. *Brazilian Administration Review*, 9, 95-117. doi: 10.1590/S1807-76922012000500007
- Seth, A. (1990). Value creation in acquisitions: A re-examination of performance issues. *Strategic Management Journal*, 11(2), 99-115. doi: 10.1002/smj.4250110203
- Shan, Y. G., & McIver, R. P. (2011). Corporate governance mechanisms and financial performance in China: panel data evidence on listed non-financial companies. *Asia Pacific Business Review*, 17(3), 301-324. doi: 10.1080/13602380903522325
- Sharma, A., Branch, B., Chgawla, C., & Qiu, L. (2013). Explaining Market-to-Book ; The relative impact of firm performance, growth, and risk. *Quest of Business*, 277-293. Retrieved from <https://www.westga.edu/~bquest/2013/MarketToBook2013.pdf>

- Shen, P. (2000). The P/E Ratio and Stock Market Performance. *Federal Reserve Bank of Kansas City Economic Review*, 85(4), 23-36. Retrieved from <https://www.kansascityfed.org/publicat/econrev/PDF/4q00shen.pdf>
- Sila, I., & Ebrahimpour, M. (2005). Critical linkages among TQM factors and business results. *International Journal of Operations & Production Management*, 25(11), 1123-1155. doi: 10.1108/01443570510626925
- Silverman, B. S., Nickerson, J. A., & Freeman, J. (1997). Profitability, Transactional Alignment, and Organizational Mortality in the U. S. Trucking Industry. *Strategic Management Journal*, 18(S1), 31-52. doi: 10.1002/(SICI)1097-0266(199707)18:1+<31::AID-SMJ920>3.0.CO;2-S
- Tanriverdi, H. & Venkatraman, N. (2005). Knowledge relatedness and the performance of multibusiness firms. *Strategic Management Journal*, 26(2), 97-119. doi: 10.1002/smj.435
- Thune, S. S., & House, R. J. (1970). Where long-range planning pays off Findings of a survey of formal, informal planners. *Business Horizons*, 13(4), 81-87. doi: 10.1016/0007-6813(70)90162-X
- Venkatraman, N., & Ramanujam, V. (1986). Measurement of Business Performance in Strategy Research: A Comparison of Approaches. *Academy of Management Review*, 11(4), 801-814. doi: 10.2307/258398
- Wahla, K., Shah, S., & Hussain, Z. (2012). Impact of ownership structure on firm performance evidence from non-financial listed companies at Karachi Stock Exchange. *International Research Journal of Finance and Economics*, 84, 7-13. Retrieved from <http://bit.ly/2G19nWG>
- Wu, W. T. (2014). The P/E Ratio and Profitability. *Journal of Business & Economics Research*, 12(1), 67-76. doi: 10.19030/jber.v12i1.8380

## Contact information

### Ing. Abu Bawa

Tomas Bata University in Zlín, Faculty of Management and Economics  
 Mostní 5139, 76001, Zlín, Czech Republic  
 E-mail: [bawa@utb.cz](mailto:bawa@utb.cz)  
 ORCID: 0000-0001-7942-3169

doi: 10.7441/dokbat.2019.007

# LOW-COST REAL-TIME MEASURING AND ANALYSIS SYSTEM FOR INDUSTRIAL ENVIRONMENTS

*Primož Bencak, Dušan Fister, Tone Lerher*

## Abstract

The increasing number of sensors used in industrial environments generate a need for systems, which are capable of processing multiple data streams and converting them into usable information. In this article, we present the development and usage of a real-time measuring and analysis system designed for use with various sensors in industrial environment. The focus of this paper is a simple encoding protocol running on a digital signal controller which transmits data at high speeds over serial communication interface to a personal computer, where they are decoded. Data are being refreshed and graphed on screen at sampling times up to 1.5 milliseconds in a C# application, which enables fast and efficient data logging. Digital signal controller in combination with wireless modules allows multiple sensors to be used in same room with a central decoding unit. The proposed system could be used in an industrial environment where various sensors with high sampling rates are used and fast data logging is required. The proposed protocol was tested on a robotic mechanism.

*Keywords: digital signal controller, data logging, real-time measuring, industrial sensors, data acquisition system*

## 1 INTRODUCTION

Nowadays it has become increasingly important for various scientific fields to interconnect themselves to achieve better products, services and general improvement in the quality of life. Industrial processes are heavily supported by various information technologies and services, which could not even exist without them. Processes require various data streams to function properly, for tasks such as close-loop control, diagnostics or security. Sensors provide information about the environment in the form of analogue or digital data. To capture information, they must be connected to various controllers, such as microcontrollers (MCU), digital signal controllers (DSC), programmable logic controllers (PLC), field-programmable gate arrays (FPGA) or even micro-computers.

The data captured with any of the mentioned devices are not usually directly accessible to a person operating the device but must first be sampled by a computer software. Altogether, the process can be described as data acquisition process (DAQ), which is “the process of measuring an electrical or physical phenomenon such as voltage, current, temperature, pressure, or sound with a computer” (National Instruments, 2019b). Several low-cost DAQ solutions have been proposed, such as Haizad et al. (2016) who proposed a low-cost real-time data acquisition system for process automation and control based upon Arduino Mega 2560 microcontroller, which transmits data over serial communication interface to MATLAB. González, Olazagoitia and Vinolas (2018) proposed an automotive DAQ which uses Arduino Due as a primary controller. It collects information of multiple accelerometers and saves them onto SD card to study suspension dynamics of a personal vehicle. Alexandria et al. (2017) have developed a DAQ for biodigester system based on Raspberry Pi micro-computer. After the data have been collected, they are sent to a web server and thus enable user access via PC, tablet or a smartphone. All these systems are appropriate for measuring data at lower sample rates and therefore fall short in real-time measurements for advanced industrial application. For such



systems, typically, a commercially available system is used, but its software cannot be modified and is more expensive. Low-cost DAQ's are usually built around Arduino line of microcontrollers but are inappropriate for industrial environments. They have low processor speed and low resolution analog-to-digital converter (ADC), which makes them generally less suitable for DAQ application, especially where faster sampling rates are required. Some of the proposed solutions use commercially available software for capturing the data e.g. LabVIEW (John et al., 2017) while others have written their own software in Python (Erraissi et al., 2018) to capture it. These also differ in the mode of how the data is transmitted from a controller to the destination system. More information about building measurements system can be found in (National Instruments, 2019a). The proposed measurement and analysis system on the other hand is more expensive but features a much faster central processing unit (CPU), higher resolution analog-to-digital converter (ADC) (up to 16 bits) and multiple communication interfaces, making it appropriate for control applications. This paper will focus less on the hardware used, but more on implementation and usage of a simple protocol, designed for real-time measuring and analysis of a data stream in industrial or educational environments.

## 2 ENCODING/DECODING PROTOCOL

The proposed encoding/decoding protocol can be implemented on any controller, which supports Serial Communication Interface (SCI). Universal asynchronous receiver-transmitter (UART) is a computer hardware device responsible for converting incoming and outgoing data into serial binary system (Codrey Electronics, 2018). It is a part of SCI, which is a more general communication interface.

In general, for building a DAQ, DSC is desired as it is designed for fast multiplication and division operations, which take place in the process. The basic principle of our protocol is to break down measured data into multiple smaller numbers. To do this, first we need to acquire data from a sensor and in the next step, break the  $n$ -length number (where  $n$  represents the number of digits), into  $\text{ceil}(n/2)$  two-digit numbers (00-99). The reason for this lies in the operation of UART. In the 8-bit UART configuration, 8-bits are reserved for data transmission, which allow transmission of number between 0-255. If the raw data is captured with a serial port monitor application, the data stream represents string of characters (ASCII code). Since the maximum number that can be sent with one byte is  $< 999$ , the proposed protocol uses only two digits instead of three for the process. The proposed protocol was tested on a robotic mechanism, shown in Fig. 1 and showed promising results.

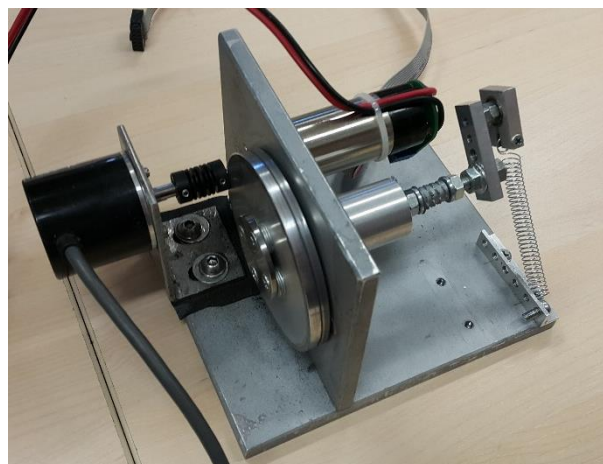

Fig. 1 – Robotic mechanism used for testing of the proposed DAQ. Source: own research

Traditionally, the UART data is ready to be transmitted on a controller by *sprintf* function, which is a part of standard C programming language library. Every single unit (digit, character or empty space) is encoded as ASCII code, hence one byte of data per unit is used. The major drawback of this approach is the number of bytes required per transmission. Also, the *sprintf* function has significant impact on controller memory consumption. Contrary, the data does not need additional decoding on a PC, and it is directly readable in serial monitor application.

The data encoded with the proposed protocol, however, cannot be directly interpreted and thus requires additional decoding for human interpretation. However, the number of bytes required for transmission is greatly reduced, since there is no need to transfer each unit as single byte. Also, decimal separators and minus signs are absent in our approach.

Data needed for transmission varies with the type of numbers used in the process, therefore data savings are variable. Mathematical approach to calculate the amount of data needed in general is omitted, hence an example is presented in Tab. 1.

Tab. 1 – Comparison of transmission data needed for both approaches. Source: own research

Method	Sync. byte	1 <sup>st</sup> meas.	2 <sup>nd</sup> meas.	3 <sup>rd</sup> meas.	4 <sup>th</sup> meas.	Bytes needed
Traditional approach	s	1000	-2500	12.50	-7.90	1 + 4 + 5 + 4 + 5 = 19 B
Proposed protocol	115	1000	2499	1250	4210	1 + 2 + 2 + 2 + 2 = 9 B

As evident from Tab. 1, the proposed protocol is saving approx. 53% of the transmitted data in the example. For the data in the first approach to be readable in serial port monitor, commas should be inserted, which would add additional three bytes. The proposed protocol does not need any additional separating characters, since the decoding interface knows the exact amount of data that is transmitted. In the worst-case scenario, the protocol is not saving any data, but also does not add additional bytes, if lowest required number of bytes is used. There are, however, limitations of the data range, shown in Tab. 2.

Tab. 2 – Limitation of data range for different number types. Source: own research

Number of bytes: 2	Lower limit	Upper limit
Unsigned whole number	0	9999
Signed whole number	-4999	4999
Unsigned decimal number	0.000	99.99
Signed decimal number	-50.00	49.99

Theoretically, arbitrary integers of length n can be transmitted using UART with a proposed protocol. However, the range of the integers needs to be limited prior transmitting the data. This applies to negative, as well as non-negative integers. It is worth mentioning that encoding the data does not affect precision.

An example below shows how a sample integer data, limited in range [-1530, 1530], is prepared for transmission:

```
temp = temp_orig + 1530;
lower_byte = temp % 100;
upper_byte = temp / 100;
```

Fig. 2 – Preparing sample integer data for transmission. Source: own research

The percent denotes a module operation (remainder by division). Two bytes are used in the process. Floating point numbers (or any higher precision decimal numbers) could also be transmitted using such solution, but precision might be lost in the encoding process. The resolution is not fixed, as it changes with number of digits. For example, if the data to be encoded is  $-1 < data < 1$ , using two bytes for the process, three digits after decimal point are preserved.

In the pseudocode bellow, a sample decimal data, limited in range [-50.0, 49.99] is being encoded on a DSC:

```
speed = (((float) speed_orig + (float) 50.0) · (float) 100.0);
lower_byte = ((unsigned char) speed % 100);
upper_byte = (unsigned char) (speed / 100);
```

Fig. 3 – Preparing decimal data for transmission. Source: own research

The received signal on PC is decoded as follows:

```
temp = data - 1530;
speed = (float) data / (float) 100 - (float) 50;
```

Fig. 4 – Decoding procedure. Source: own research

where *data* represents merged, but not yet decoded bytes. A more detailed explanation is shown in Fig. 7.

## 2.1 TIMING CONSIDERATIONS

The specific DSC has been chosen, because it offers high clock speed (up to 200 MHz), four SCI units and 16 - level FIFO (first-in-first-out buffer) registers. The latter is important to reduce CPU waiting time as it allows 16 bytes of data to be written into the buffer at once. Partial writes to the FIFO buffer are also permitted. The TMS320F28379D also offers ADC with selectable resolution between 12 and 16 bits (Texas Instruments, 2019). Transmission of the data is hardware related (SCI units) and once data has been written to the buffer, CPU can perform other tasks, not having to wait for the end of transmission, even without the use of the CPU interrupts. At maximum baud rate 921.600 bps at 200 MHz CPU clock frequency, one byte of data is transmitted in approx. 17  $\mu$ s from DSC to the PC. Time needed to transfer one byte of data was measured using oscilloscope, which measured pulse length of the DSC output pin. It was set “high” when the transmission started and “low” when it finished sending the data. Since the communication runs one way only (simplex), the time required to send *n* bytes is easily derivable:

$$T_{kom} = \begin{cases} n \cdot 60 \text{ ns}, & n \leq 16, \\ n \cdot 60 \text{ ns} + 17 \mu\text{s} \cdot n, & n > 16, \end{cases} \quad (1)$$

where *n* represents number of bytes to be sent. The CPU time of 60 ns is the time needed to store the variable into the UART buffer. Additionally, it is trivial to calculate how many bytes can be sent in one cycle. This equation does not account CPU time needed for encoding process, because different number formats take different time to be encoded. However, to encode 16 bytes of sample data (4 measurements) in our application, around 2  $\mu$ s of CPU time was used, measured using the same technique as above.

The number of maximum bytes sent scales accordingly to the % of processing time used for retrieval of sensor data and other algorithms that are being used. Because the TMS320F28379D features two CPU's, one CPU could be used entirely for communication and the second one for executing other tasks, but first, the data needs to be sent between processors. Also having two Control Law Acceleration units (CLA) which run asynchronously from the main CPU, they can be used for extremely fast analog-to-digital conversion (i.e. over-current protection).

To prevent transmission (communication) errors, a synchronization byte is added before the encoded data, which ensures that the data does not get desynchronized in the process of retrieving it from serial port. Fig. 5 shows a data packet, which carries information of *n*-different measurements in step *k*. The byte, which is sent last from a DSC, also arrives last to the PC.

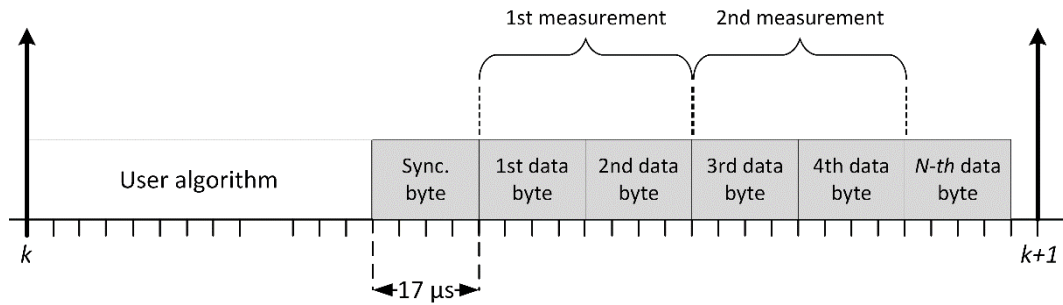

Fig. 5 – Data packet of  $n$ -measurements. Source: own research

If logic states of sensors with binary operation (i.e. switches) are required to be sent, a slight modification to the original pseudocode can be made to improve protocol efficiency. Instead of two-digit number, three-digit numbers can be sent (Tab. 3), where each of the digits represents switch state. However, values including and above '112<sub>(10)</sub>' (character 'p' in ASCII code), should be reserved for synchronization bytes to avoid decoding errors.

Tab. 3 – Example switch states encoding. Source: own research

Switch 1	Switch 2	Switch 3	Switch 4	Switch 5	Switch 6
1	1	0	0	1	1
1 <sup>st</sup> byte: '110 <sub>(10)</sub> ', ASCII: 'n'			2 <sup>nd</sup> byte: '11 <sub>(10)</sub> ', ASCII: 'VT'		

### 3 IMPLEMENTATION

TMS320F2879D Launchpad DSC (Fig. 6) is connected to a PC via micro-USB cable. It features onboard USB to RS232 trans-receiver, which eliminates the need for external hardware, if only one SCI (SCI-A) unit is used. However, if multiple SCI units are needed (higher data transmission), they must be connected to a PC with additional hardware. TMS320F28379D Launchpad can work with two additional SCI units, SCI-B and SCI-C. These can be connected to multiple/different PC's.



Fig. 6 – Texas Instruments TMS320F28379D Launchpad. Source: own research

PC interface, named 'DP Scope' is responsible for decoding the incoming data and logging it onto graphs. It was developed in Microsoft Visual Studio 2017 in a C# programming language. The interface uses class Serial Port, which reads incoming data from asynchronous routine called `await serialPort.BaseStream.ReadAsync`. The routine is executed every time a new packet (byte) of data is ready to be read. More information about using the routine can be found in (Microsoft NET, 2019).

After receiving predefined number of bytes, a decoding process is executed. Received characters (marked with ') are firstly converted to its integer equivalents. Before they are merged together, they must be converted to string format (marked with "). If the byte integer

equivalent is less than '10', '0' must be added before merging the two numbers together. In the next step, a decoding procedure is executed (Fig. 7) to retrieve the original information.

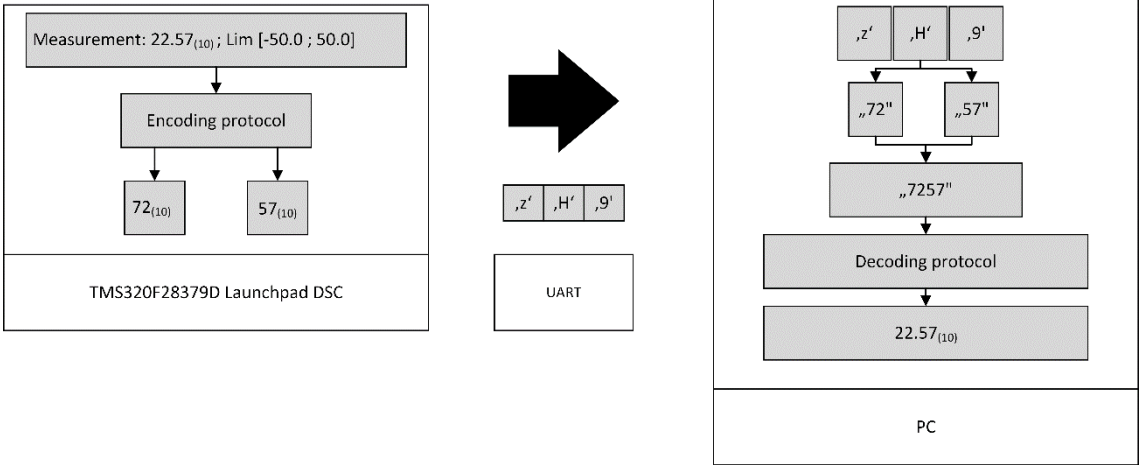

Fig. 7 – Example encoding/decoding process. Character ‘z’ denotes synchronisation byte. Source: own research

Finally, the data are shown on graph in real-time. Complete receiving and decoding process is CPU intensive, so a maximum of 8,000 points (12 seconds at 1.5 ms sampling rate) are shown on graph simultaneously. After the graph is filled with data points, the program automatically saves them into a \*.csv file for further analysis. 'DP Scope' can operate in three basic modes: Free Run, Triggered and Continuous Cycle Measurement (CCM). The first mode offers oscilloscope-like view, where the data are displayed, logged and cleared sequentially before new data capture follows. This mode is especially useful for testing and debugging sensors. Second mode offers capturing data only after its value reaches predefined trigger level. The third mode, CCM, is programmed to capture data over longer periods of time. This mode operates in following order: (1) Data is loaded until data point limit in a graph is reached. After, data points are stored in a \*.csv file; (2) A new capturing sequence begins, clearing data in graph; and (3) New data are displayed in graph until data limit is reached. After that, first step in repeated.

The third mode is specifically designed to observe sensor data behaviour over longer periods (i.e. room temperature). Data saved in \*.csv files are exported in a folder with a predefined name, date and time. The person carrying out measurements is welcomed to fill few metadata attributes (i.e. number of measurements, sensor type, etc.). Besides, MATLAB scripts are saved, so the data can be plotted and modified later in a predefined format, as shown in the section "Results".

### 4 EXPERIMENTS AND RESULTS

In this section, the results of using the proposed DAQ are shown. The goal of our experiments is to verify the integrity of the transmitted data, evaluate repeatability and plot error figure. Also, 'DP Scope' interface, which was used for receiving and decoding the data is presented. During the experiments, PC configuration used is shown in Tab. 4.

Tab. 4 – Used PC configuration. Source: own research

Processor	Intel i5 4570 @ 3.20 GHz
Memory	16 GB DDR3 1600 MHz
Graphics card	AMD Radeon 7770 OC Edition
Storage	250 GB SSD
Operating system	Windows 10 Education

In order to verify the sent data, a test sine waveform was sent from the DSC and compared to the original data, generated in MATLAB. Waveform assumed the form:

$$x_r = \left\{ \pi \cdot \sin\left(\frac{4\pi \cdot t}{3}\right); 0 \leq t \leq 6 \right. \quad (2)$$

where  $t$  is the time in seconds. Both waveforms were placed in the same graph, shown in Fig 8. a. Near perfect overlapping of the reference ( $x_r$ ) and actual ( $x_a$ ) signal values sent from the DSC is evident. To further validate the results,  $x_r$  and  $x_a$  were subtracted and plotted on the graph as shown in Fig 8.b.

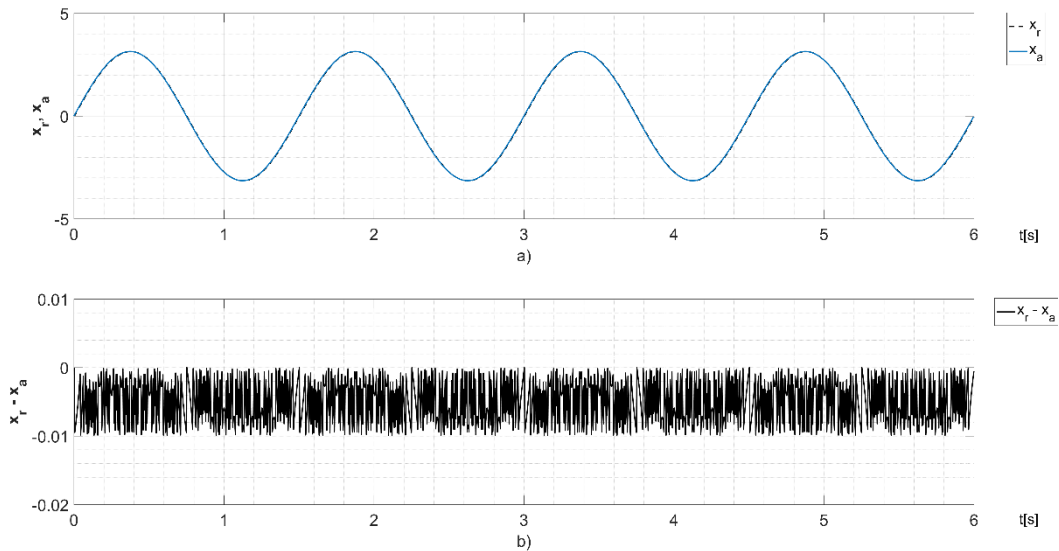

Fig. 8 – Original and transmitted data (a). Error plot of the data (b). Source: own research

The error  $e$  never exceeds value of -0.009885 in this example, which indicates acceptable accuracy even at using only two bytes for the data. However, maximum error must be determined prior to using the proposed DAQ, to confirm the adequate number of bytes for transmission. The error produced is periodical, which means, that the received data is correct through the signal. Lastly, SSE (Sum of Squared Errors) indicator was calculated for 20 test measurements, using the following equation:

$$SSE(x) = \sum_{i=1}^{samples} (x_{r,i} - x_{a,i})^2 \quad (3)$$

SSE value of 0.06732 was calculated for each of the 20 measurements, which confirms error-free data transmission and repeatability.

Tab. 5 – Analysis of the transmitted data for Fig. 8. Source: own research

Data points per measurement	2000
Bytes of data used for measurement	2
Number of measurements	20
Transmission rate	3 ms
Max. relative error	0.59 %
Max. absolute error	-0.009885
Sum of Squared Errors (SSE)	0.06732
% of correctly transmitted data	100.00 %

During the testing, a transmission rate of 3 ms was used, but the DP Scope interface was found to be stable at receiving 16 bytes of data (6 different measurements) at rate of 1.5 ms (10,667



B/s ~ 85,333 bps). The number of received data could be increased with faster PC. Fig. 9 shows the main window of the 'DP Scope' interface.

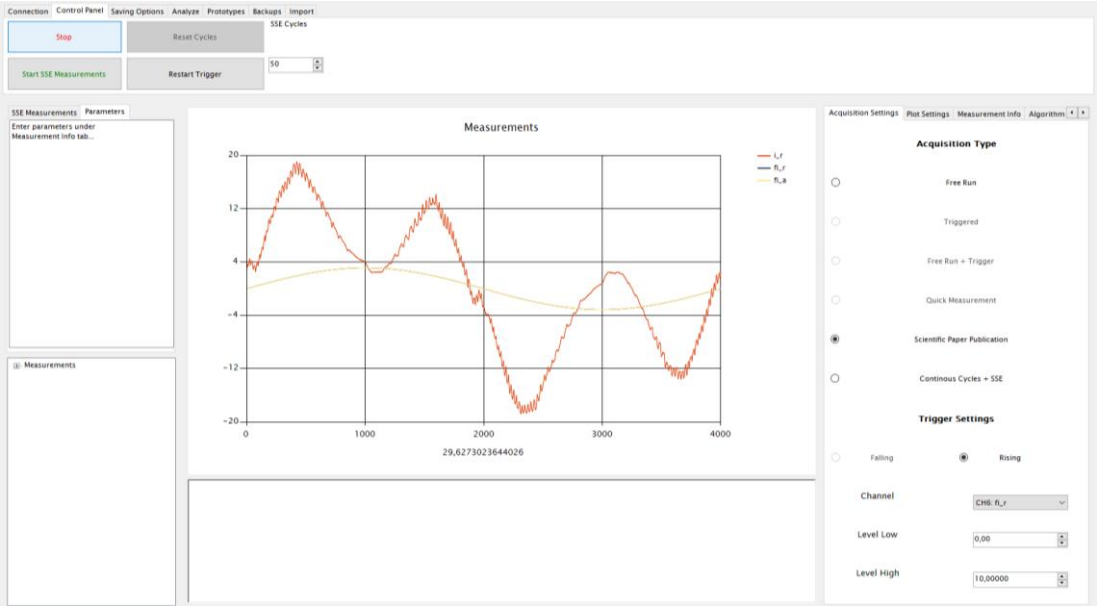

Fig. 9 – Main window of the ‘DP Scope’ interface. Source: own research

Graph occupies a larger portion of the main screen, whereas other settings are docked in the right corner. Console is located beneath the graph and is useful for printouts. Container on the left side is intended for data, which does not require graphing, but represents discrete data (i.e. switch states). Settings are located above the graph and allow the user to run or stop the measuring process. The Fig. 10 shows automatically generated MATLAB plot with data, captured by the ‘DP Scope’.

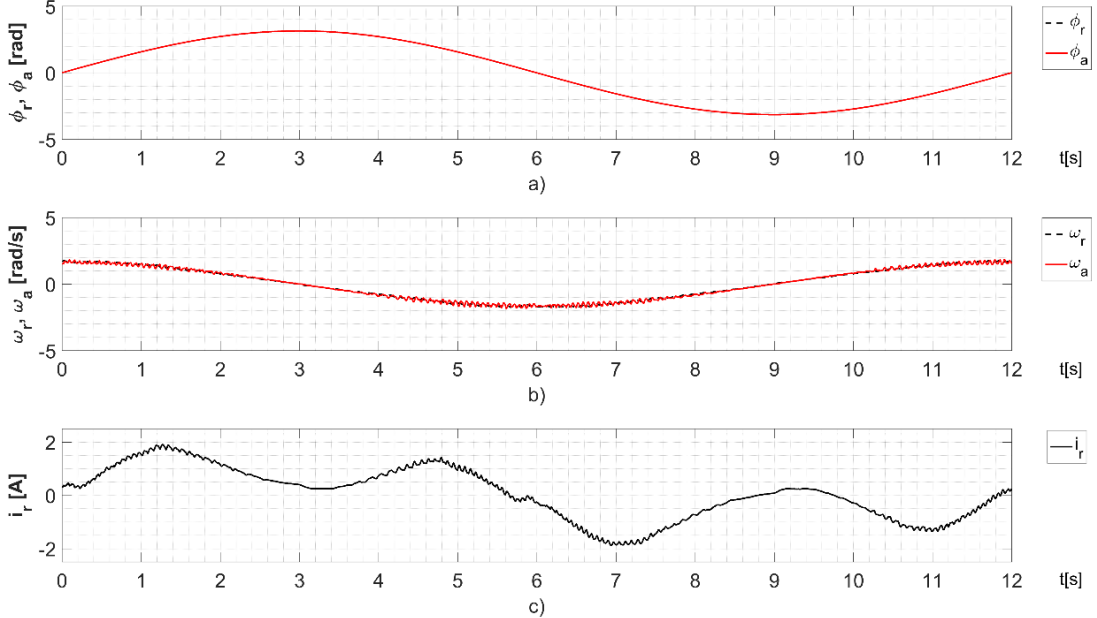

Fig. 10 – MATLAB plot of data captured by ‘DP Scope’ interface. Source: own research

## 5 DISCUSSION

The proposed DAQ behaves as expected. As opposed to the traditional technique of transmitting one byte of data per character (digit), we are saving 53% of data required in our example. By not using the standard library function *sprintf* to convert the data into ASCII format, controller memory savings are also noticeable. The data, however, must be decoded first, so a custom-built interface for decoding the data must be used, else the data is unreadable by a standard serial monitor application. Data transmission is proven to be reliable, as shown in Tab. 5, hence no error correction is needed, although PC lagging occurred occasionally. Despite the slight sacrifice of decimal numbers precision, the total generated error proves, that the precision lost over the encoding process is negligible even at using the lowest possible number of bytes. Additionally, decimal number precision is selectable, and more bytes can be added, if greater resolution is required. The proposed protocol is inadequate if fixed resolution on decimal numbers must be used. Another drawback is the CPU intensive decoding on PC. However, the decoding capabilities vary with data sampling time (time before the new packet of data arrives). In our case, a very demanding diagnostics was performed, since our sample time was 1.5 ms. This could be improved if only one out of multiple measurement would be decoded in real-time and the others at the end of the measurement cycle.

## 6 CONCLUSION

The described system serves as a low-cost diagnostics and logging tool useful in various industrial and educational environments. The proposed DAQ was initially developed for logging and diagnosing simulated robotic mechanism and intelligent control algorithms, shown in Fig. 1. However, the system showed potential as a debugging tool for various sensors. It is easily adaptable to the specific user needs, as it features simple and straight-forward implementation. Although the DSC and the PC interface require advanced programming skills, the available documentation found online is plentiful. The extensive features of the used DSC on the other side offer connectivity with wireless modules, wide range of sensors and possibility to be used in (motor) control applications, which makes it appealing to many different fields. Lastly, CPU time saved by using the proposed protocol could be used for additional user algorithms or decreasing the sample time.

### References

- Alexandria, A. R., Gondim, F. A., Moura, L. F., Teixeira, P. F. S., Albiero, D., & Lima, S. W. S. (2017). Development of a Low-Cost Data Acquisition System for Biodigester. *Journal of Sustainable Bioenergy Systems*, 7(3), 720-726. doi: 10.4236/jsbs.2017.73009
- Codrey Electronics (2018). *UART Communication Protocol – How it works?* Retrieved from <https://www.codrey.com/embedded-systems/uart-serial-communication-rs232/>
- Erraissi, N., Raoufi, M., Aarich, N., Akhsassi, M., & Bennouna, A. (2018). Implementation of a low-cost data acquisition system for “PROPRE.MA” project. *Measurement*, 117, 21-40. doi: 10.1016/j.measurement.2017.11.058
- González, A., Olazagoitia, J. L., & Vinolas, J. (2018). A Low-Cost Data Acquisition System for Automobile Dynamics Applications. *Sensors*, 18(2), 366-386. doi: 10.3390/s18020366
- Haizad, M., Ibrahim, R. B., Adnan, A., Chung, T. D., & Hassan, S. M. (2016). *Development of low-cost real-time data acquisition system for process automation and control*. Paper



presented at 2016 2nd IEEE International Symposium on Robotics and Manufacturing Automation (ROMA), Ipoh, Malaysia. doi: 10.1109/ROMA.2016.7847826

John, M., Joseph, A., & Vasanthi, D. (2017). *Design and implementation of low cost multichannel data acquisition hardware for computer aided measurement*. Paper presented at 2017 Trends in Industrial Measurement and Automation (TIMA), Chennai, India. doi: 10.1109/TIMA.2017.8064805

Microsoft NET (2019). *Programming guide: Asynchronous programming with async and await*. Retrieved from <https://docs.microsoft.com/en-us/dotnet/csharp/programming-guide/concepts/async/>

National Instruments (2019a). *Complete Guide to Building a Measurement System*. Retrieved from [https://download.ni.com/evaluation/daq/Measurement\\_System\\_Build\\_Guide.pdf](https://download.ni.com/evaluation/daq/Measurement_System_Build_Guide.pdf)

National Instruments (2019b). *What Is Data Acquisition?* Retrieved from <http://www.ni.com/data-acquisition/what-is/>

Texas Instruments (2019). *TMS320F2837xD Dual-Core Microcontrollers: Technical Reference Manual*. Retrieved from <http://www.ti.com/lit/ug/spruhm8i/spruhm8i.pdf>

## Contact information

### **Primož Bencak, M.Sc.**

University of Maribor, Faculty of Logistics  
Celje Mariborska cesta 7, 3000 Celje, Republic of Slovenia  
E-mail: [primoz.bencak1@um.si](mailto:primoz.bencak1@um.si)  
ORCID: 0000-0002-8142-4694

### **Dušan Fister, M.Sc.**

University of Maribor, Faculty of Economics and Business  
Razlagova 14, 2000 Maribor, Republic of Slovenia  
E-mail: [dusan.fister1@um.si](mailto:dusan.fister1@um.si)  
ORCID: 0000-0002-9604-0554

### **prof. Tone Lerher, Ph.D.**

University of Maribor, Faculty of Logistics  
Celje Mariborska cesta 7, 3000 Celje, Republic of Slovenia  
E-mail: [tone.lerher@um.si](mailto:tone.lerher@um.si)  
ORCID: 0000-0001-7474-182X

doi: 10.7441/dokbat.2019.008

# MICROFINANCE AND THE MILLENNIUM DEVELOPMENT GOALS

*Marta Paula Bendelová, Artan Qineti, Martina Zaujecová*

## **Abstract**

In the last few decades microfinance has become one of the important tools of world poverty reduction. The paper is focused on analysing the effect of microfinance on the poverty levels in developing countries compared to world countries. As one of the main objectives of the United Nations Millennium development goals was to eradicate the extreme poverty, our paper observes the connection between the achievement of this goal at macroeconomic level and the expansion of microfinance worldwide by using multiple regression analysis. The main aims of the paper are to examine how the microfinance contributed to achievement of the Millennium development goals (mainly eradicating extreme poverty, the health improvement, gender equality and developing universal access of children to education) and to determine how the macroeconomic indicators and volume of microfinance loans influence the level of poverty in the observed developing and world countries. We compared the results of 73 world countries with 53 developing countries. The results of regression analysis show that in case of developing countries there has been proven the significance of relationship between the domestic credit provided by banking sector, gross domestic product, gross loan portfolio and poverty. The lower was the value of this variable the higher was the level of the poverty. However, in analysis of observed world countries only GDP per capita had some effect on poverty.

**Keywords:** *microfinance, developing countries, Millennium development goals, regression analysis*

## **1 INTRODUCTION**

Microfinance has become one of the phenomenon in today's world and is getting more and more popular and spread among the developing countries surprisingly fast. It reaches people who are mostly self-employed, employers with low income from both rural and urban areas. These self-employers are generally small entrepreneurs, farmers or services providers (Ledgerwood, 1999). Therefore, the analysis of the impact of microfinance on the economy of developing countries would be very helpful to be able to predict the possible risks of this phenomenon. As the financial exclusion is simultaneously a cause and a consequence of poverty and social exclusion, it is important to include microfinance in the current research areas (Gloukoviezoff, 2010). Due to the fact that microfinance institutions provide various financial and non-financial services, they can have an effect on participants in a way that goes far beyond the income and consumption patterns (Duvendack et al., 2011; Karlan & Goldberg, 2011; Balkenhol & Guézennec, 2013; Bédécarrats & Lapenu, 2013; Banerjee, Karlan & Zinman, 2015). What is more, the different features and ways in providing the services might also influence the impact on clients. The example of these different features could be the amount lent or the possibility to delay the beginning of the repayment period are the variables that may also have an effect on the clients (Bédécarrats & Lapenu, 2013; Gloukoviezoff & Rebière, 2013; Banerjee, Karlan & Zinman 2015). Copestake (2014) describes the problem: "The underlying problem here is the complexity of the context. By this I mean that the influence of X on Y is confounded by factors Z that are impossible fully to enumerate, of uncertain or highly variable value, difficult to separate, and/or impossible fully to control. Additional complexity arises if the nature and value of X and/or Y is also uncertain". The complexity of the problem, however, is often underestimated and could have led to over-generalization of the positive impact which

was too related to specific context and to specific clients and to “an emphasis on overly standard and simplistic models that are easily scaled up through replication” (Copestake & Williams, 2011). There are therefore controversial studies in studying the effects of microfinance. Duvendack et al. (2011) concluded that the supporting microfinance policies have no empirical basis. Moreover, there are other problems with methodology of these studies which show positive effects of microfinance, in particular the selection bias and unobservable characteristics (Duvendack, 2010). Bateman and Chang (2012) argue that ‘microfinance actually constitutes a powerful institutional and political barrier to sustainable economic and social development, and so also to poverty reduction’. Ghosh (2013) states that microfinance cannot be a biggest tool in development and that microfinance institutions whose primary goal is profit are problematic. On contrary to these research papers, the results of Imai et al. (2012) found that microfinance significantly reduces poverty at macro level, specifically that the country with higher MFIs' gross loan portfolio per capita tends to have lower levels of poverty indices. In this research paper we develop the model of Imai et al. (2012) on the more recent data. As the poverty reduction was one of the Millennium development goals we brought the insight to the role of microfinance in achieving other Millennium development goals which was introduced by Prasad (2017). The main aims of the paper are therefore to examine how the microfinance contributed to achievement of the Millennium development goals (mainly eradicating extreme poverty, the health improvement, and gender equality and developing universal access of children to education) and to determine how the macroeconomic indicators and volume of microfinance loans influence the level of poverty in the observed developing countries.

## **2 THEORETICAL BACKGROUND**

### **2.1 The Contribution of microfinance in Achieving the Millennium Development Goals**

There are eight objectives of Millennium development goals of the United Nations targeting to for example fight the poverty and hunger, empower the women in developing countries as well as to reduce the maternal and child mortality. The all members of UN have committed to specific targets regarding education, health, nutrition, environment, and gender equality. Microfinance is not exclusively about business loans, but it is interconnected with health or education as the microfinance clients use their financial resources not only for business investments but also to meet their greater variety of needs. A study that examined countries from all over the world confirms that when the share of household income controlled by women increases, the more are money spent for benefit of children (World Bank, 2011). Therefore, the access to finance for women is crucial for further social and financial development. The data from Microfinance Information Exchange (MIX, 2018) show that 70% of microfinance clients are women. Finances in hand of women increase their self-confidence and indirectly supports their decision-making ability to have and as a result positive social outcome like improved child mortality, nutrition, education and health (CGAP, 2002). Moreover, when microfinance loans are provided to poor women, they experience the rise in incomes and savings and improved nutrition and health (Dunford, 2006). The experience show, that the clients of microfinance are more likely be able to increase their incomes, reduce their vulnerability to the unexpected life events and subsequently their living standards (Littlefield, Morduch & Hashemi, 2003). For these reasons was MF considered as one of the tools to achieve Millennium development goals in MDG Summit 2010. The important fact that needs to be highlighted is that there are eight different Millennium development goals and microfinance is helpful in at least half of them. In the following part there will be described the studies that found microfinance helpful in achieving the MDGs.

## **Eradicating poverty**

The Millennium development goal of reducing the poverty level was defined as a goal to reduce the proportion of people who suffer from hunger by 50% between 1990 and 2015. Microfinance represents a way for poor people to increase their incomes, to save and subsequently to escape poverty and hunger. The possibility to borrow small amount of money to run the business or to pay for education can be one of the first steps in the way out of poverty. Moreover, the ability to save and collect money for buying assets, inventory or to provide the education for children. Especially savings and insurance services are essential tools to protect the poor from the extreme vulnerability to the unexpected events which are characteristic for the developing countries. The results of the study of Miled and Rejeb (2015) show that a country with higher gross loan portfolio in terms of microfinance loans provided per capita tends to have lower levels of poverty at the macro level. A research of household panel data confirms a positive impact of microfinance on food consumption growth, which is also related to the effects of reduction of poverty in Bangladesh (Imai & Azam, 2012). A case study from Northeastern Mindanao (Philippines) show that microfinance has a positive impact on poverty reduction as the incomes and savings of microfinance clients were found to be higher than those of non-clients (Agbola, Acupan & Mahmood, 2017). MkKelly and Dunford (1999) examined the case study of Bolivia, where the incomes of two-thirds of MFI clients had risen after engaging to the microfinance program. Furthermore, the research shows that the savings of 86% of clients had increased and 78% stated that they did not have savings before joining the program. The other case study from Indonesia shows that incomes of the MFI clients have increased by 112% and 90% of them were able to escape poverty. As a result of enabling access to financial services for the poor women, the living standards of poor families have increased significantly (Drioadisuryo & Cloud, 1999). The World Bank initiated the study from Bangladesh, examining three of the largest microfinance programs, namely Grameen Bank, BRAC and RD-12. The results show that that the household consumption of women clients have increased by 18 takas by each 100 takas that were borrowed. The study highlighted that the clients were able to escape poverty in a sustainable way, which means that the microfinance has a long-term impact on the lives of poor people (Khandker, 1998). The studies listed above indicate that the microfinance could help the developing countries to reach the first millennium development goal as they show a positive effect of microfinance on reducing poverty levels.

## **Developing universal access of children to education**

Another Millennium development goal is to ensure a completion of full course of primary schooling for children everywhere, boys and girls alike, by the year 2015. The results from the recent study from Martinez (2016) show that there are positive effects of microfinance on the rate of secondary education enrolment, mostly in case of females, but it has insignificant effects on primary education enrolment rates. Viswanath (2018) found that microfinance has an impact on the level of interest in education as mediated by wealth effects and status effects. Focus group interviews suggest that the impact of microcredit on the demand for education comes mainly from the greater access to financial resources and, to a lesser degree, from an accompanying appreciation of the value of education. Generally, when poor people experience an increase in their incomes from microenterprises, they use to invest more in their children's education. The studies have shown the similar results, specifically, that the children of the MFI clients more likely enrolled to education and what is more, they are more willing to continue with their studies. To react on this trend, many MFIs are interested in developing new savings products aimed to save on education fees (Littlefield, Morduch & Hashemi, 2003). The other research observing the Grameen bank's impact on education shows that the children of Grameen members experienced higher level of education than those who were not engaged in

microfinance program. The children from Grameen households, especially girls were much more educated than the children of the Grameen non-members (Khandker, 1998).

The effect of microfinance on school enrolment ratios had been proven as well. The case study from Ahmedabad in India stated that the children (especially boys) of microfinance clients were more likely to enrol to secondary school (Chen & Snodgrass, 2001).

### **The health improvement of children and women**

The third goal were the effect of microfinance has been proved is to decrease by a half by 2015 and begun to eradicate the incidence of malaria and other major diseases. One of the biggest problems that poor people have to face is illness. The poverty goes often hand in hand with diseases because they are not able to work and due to the related expenses, such as medicaments. The better nutrition of microfinance clients increases the probability of better health outcomes in comparison to non-clients. The microfinance programs help to ensure stable and higher incomes that significantly contribute to the better living conditions, healthcare and nutrition. Moreover, some of the MFIs provide so called health training where the clients are offered education in terms of safe drinking water or immunization as well as they offer credit products for sanitation, housing and water. The access to health insurance offered by MFIs has also impact on the health outcomes (Littlefield, Morduch & Hashemi, 2003). Findings of Posso and Athukorala (2018) confirm that when the number of MFI clients increased, a country has a lower under-five and infant mortality rates. We conclude that if MFIs' educational and health services have indeed caused improvements in health outcomes at the community level. The study in Ghana shows that one-year-old children of Freedom from Hunger (microfinance programme) clients were healthier than those of non-clients as a result of better health practices such as after birth breast-feeding and providing the therapy of rehydration to children with diarrhoea (MkKelly & Dunford, 1998). As for the BRAC clients in Bangladesh, the study stated that fewer of them suffered from malnutrition as well as they more likely joined the health and nutrition practices (95%) in comparison with the 72% in case of non-members. Furthermore, 32% of BRAC clients engaged in AIDS-prevention practice at least once compared with 18% who were not clients (Barnes, Gaile & Kibombo, 2001).

### **Gender equality and empowerment of women**

From the very beginning, the microfinance institutions are oriented on the women as clients. Generally, women have proven their reputation as those who are more responsible in terms of finance and who have better performance in repaying their debts. Moreover, they invest their money much more likely in family and household than their husbands. Ensuring access to financial services for women helps them to find their confidence and to be able to make their own financial decisions. Microfinance assists them to gain a higher social status in community and to gain the opportunity to fight the gender inequalities. The following studies prove the important role of microfinance in empowering women: the increasing ability to participate more actively in family decisions and higher investments in households and families (Littlefield, Morduch & Hashemi, 2003). The case study from Ethiopia shows that microfinance may enable women to get some extra income and also it diminishes the inequalities and a gender-specific division of labour (Haile, Bock & Folmer, 2012). The trend of rising social position of women who are clients of MFIs are seen in the case study from Nepal. In particular, 68% of the women members increased their influence in family decision-making in terms of property management, children's life decisions (education, marriages, etc.) or decisions related to family itself. In case of Philippines, the women engaged in TSIP program were more likely principal fund managers (51%) than those who were in the control group and did not participate in the program (31%) (Cheston & Kuhn, 2002). Another case study from Bangladesh observing 1300 members and non-members of microfinance programs shows that the involvement in credit program had a

significant impact on empowerment of women-clients than non-clients. They had a higher control over property, and they had increased influence on decision-making. Moreover, they were much more informed about politics and legislative. The longer they stayed in the program the higher was the empowerment of the women-members (Hashemi, Schuler & Riley, 1996).

All of the studies previously mentioned have proved that the microfinance could play an important role in achieving the Millennium development goals. The regression analyses in the following part will analyse this impact and provide the deeper analysis of relationship between the microfinance and achievement of UN Millennium development goals – mainly the goal of reducing the world poverty.

### **3 METHODS**

Data from official websites of institutions, namely, from the World Bank (2011) and Microfinance Information Exchange (MIX, 2018) are used for analysis in this paper. The two groups of countries are analysed: the world and the developing countries. While in the world analysis, there are included 73 countries based on available data, in the developing countries model we excluded the non-developing countries which decreased the number of observations to 53 countries. The developing countries have been chosen in accordance with the UN list where the countries are categorized by their level of development. In analysis there are divided countries into groups according to regions as follows: (1) Africa; (2) Eastern Asia and Pacific; (3) Eastern Europe and Central Asia; (4) Latin America and Caribbean; (5) Middle East and North Africa; and (6) South Asia.

The analysis which studies the effect of GDP per capita, GLP and domestic credit on poverty ratio, the indicators are chosen based on the research from Imai et al. (2012). The data are from the year 2015 because the member states of UN agreed to reach the Millennium development goals by the year 2015 and so we are able to identify the results of the development process.

#### **3.1 Description of variables**

The variables for the analysis are chosen in accordance with the previous study of Imai et al. (2012) where the authors used the same variables, namely:

Domestic credit provided by banking sector – represents all credit that is provided to various sectors of the countries by banks in form of loans or securities as a percentage of GDP.

Gross Loan Portfolio – refers to total loans provided by microfinance institutions to people in millions of USD.

Poverty headcount ratio at \$1.90 a day – is a percentage of population who live at less than \$1.90 a day.

The study of Imai et al. (2012) analysed the relationship between the microfinance and poverty from the macroeconomic point of view. They found out that the countries with higher gross loan portfolio, gross domestic product and domestic credit tends to experience lower poverty level. They tested the hypothesis of microfinance reducing poverty at the macro level. The cross-country and panel data were used which were collected by Microfinance Information Exchange (MIX, 2018) data on Microfinance Institutions (MFIs) and the World Bank data.

Prasad (2017) examined the role of microfinance in achieving the Millennium development goals (MDGs) accepted by United Nations in 2010. The aim of a research was to find how is microfinance and MDGs related to poverty, school enrolment at primary level of female and ratio of girls to boys in primary education. The method of pooled ordinary least square regression was used, three models were separately developed for the chosen MDGs. Results

show that there is linkage between the microfinance and poverty reduction, however, the relation between the education and microfinance programmes was less significant.

As for the evaluation of the microfinance impact on the economy of developing countries we use multiple regression analysis – the same analysis that was chosen also by other studies mentioned above. The aim of regression model is to characterize the relationship between the independent and dependent variables. It seeks the mathematical function that is called regression function or model that would express the relationship the best. After removing the outliers from the model, the regression analysis was applied. We analyse the relationship between dependent (GLP, GDP, Domestic Crd) and independent (Poverty) variables. The estimation of the linear model could be expressed by the following formula:

$$Pov_i = \beta_0 + \beta_1 GLP_i + \beta_2 GDP_i + \beta_3 Domestic\ Crd_i + \varepsilon \tag{1}$$

In the formula above the “Pov” represents a poverty headcount ratio at \$1.90 a day; “GLP” is for the gross loan portfolio and “Domestic crd” indicates the domestic credit provided by banking sector (as a percentage of GDP). In the analysis, we transformed the data to Lin-Log model as we wanted to interpret the results in percentage and reduce the heteroscedasticity of the model.

The hypotheses for our regression analyses are stated as follows:

*H0 – there is no significant relationship between the variables*

*H1 – there is a significant relationship between the dependent and independent variables*

The hypotheses were accepted or rejected by using the test where we compared the p-value with significance level  $\alpha = 0.05$ . When the p-value was lower than alpha, we accepted the H1 hypothesis and reject the null hypothesis. On the other hand, when the p-value was higher than 0.05, we rejected the H1 hypothesis and accept the H0 hypothesis.

## 4 RESULTS

In the paper we analyse the relationship between volume of microfinance, GDP per capita, domestic credit provided by banking sector and poverty in the chosen countries.

### 4.1 Descriptive statistics

In the regression analysis we examined dataset of 73 world countries and 53 developing countries that included information about GDP per capita, Domestic credit provided by banking sector, Gross loan portfolio (GLP) and poverty from the following regions.

Tab. 1 – Observed Regions and Number of Countries. Source: own research

Region	N. of countries (World analysis)	N. of countries (Developing countries analysis)
Africa (A)	19	19
East Asia and Pacific (EAP)	6	5
Eastern Europe and Central Asia (EECA)	18	0
Latin America and Caribbean (LAC)	17	17
Middle East and North Africa (MENA)	7	7
South Asia (SA)	6	5
Together	73	53

As we mentioned before, the world-oriented analysis was chosen for better illustration of differences between the developing countries and world in terms of microfinance impact. In the table above we can see how many countries were used in regression analysis by region. Basically, we have chosen countries where microfinance is used as an economic and poverty

reduction tool as the microfinance is still not spread in many countries in the world. The difference is seen in the region of Eastern Europe and Central Asia region (EECA) where none of these countries are developing countries and therefore this particular region couldn't be included in the second analysis of developing countries. Before the analysis itself, we need to describe the dataset which were used as an input data for the regression model. From the Tab. 2 we can see that there are only slight differences between the mean values of world countries and developing countries. The only case of more significant difference is the Poverty headcount ratio where we can see that in developing countries is this ratio higher by 5% when compared to world mean.

Tab. 2 – Descriptive Statistics of Observed Dataset. Source: own research

Indicator		Mean	Median	Stand. deviation	Min	Max	Measure
Domestic crd	World	55.4	48.3	38.3	-0.4	196.2	% of GDP
	Developing countries	57.6	46.8	43.1	8.70	196.2	% of GDP
GDP	World	4,142.3	3,077.0	3,707.8	362.6	13,750.2	USD
	Developing countries	3,845.5	2,457.4	3,822.8	362.6	13,750.2	USD
GLP	World	1,204.9	239.0	2,287.5	0.7	11,640.8	million USD
	Developing countries	1,483.0	250.6	2,604.0	12.1	11,640.8	million USD
Poverty headcount	World	15.8	5.0	19.7	0.0	65.7	% of population
	Developing countries	20.5	12.6	20.6	0.0	65.7	% of population

However, mean is affected by outliers and therefore it could be more representative to compare the medians. The table shows that the median value for the poverty headcount ratio of developing countries is more than two times higher than the median of the world countries. It means that the developing countries struggle with significantly higher poverty rates than in case of world countries. The other interesting point which comes out from the table is that the volume of microfinance loans (GLP) has a wide range from the minimum value to maximum. It means, that the countries differ significantly in their engagement in microfinance services.

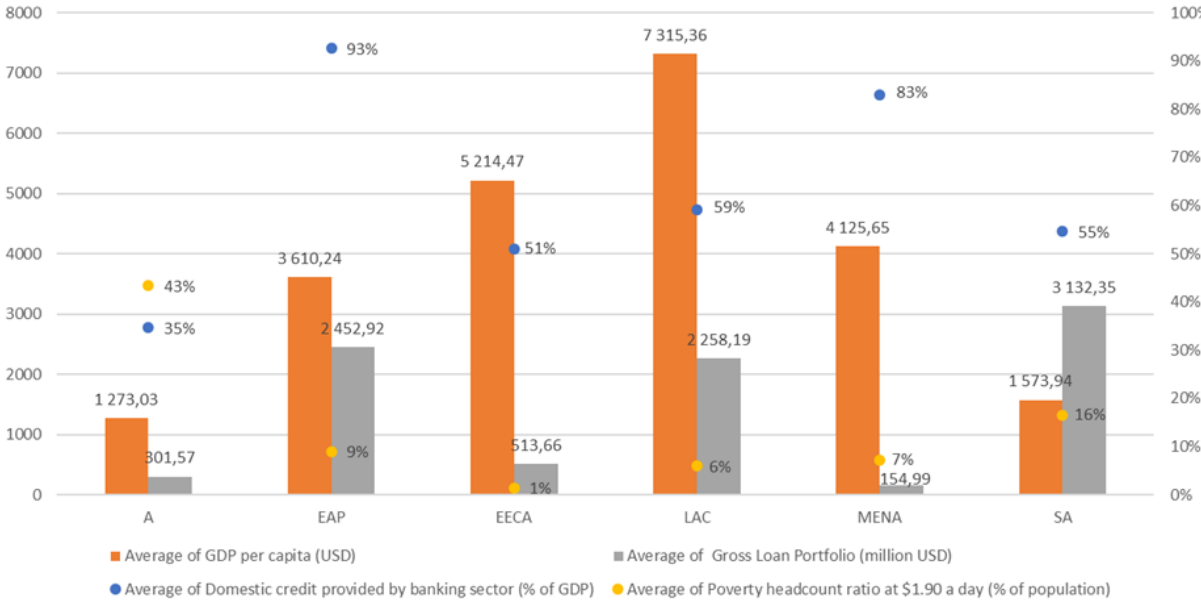

Fig. 1 – Average Values of Indicators Based on Regions – World countries Analysis. Source: own research

Since we described the database only from the world and developing countries perspective, the more detailed illustration of average values by region analysing the world countries is provided



in the Fig. 1 above. With this more complex figure we can better understand and explain the great variety of regions used in the analysis. For instance, the regions with the highest volume of microfinance loans are South Asia, East Asia and Pacific and Latin America and Caribbean. On the other hand, the microfinance services are not so common in the regions of Eastern Europe and Central Asia, Africa or Middle East. From this information we can summarize, that the microfinance is an important tool for reaching the poor mostly in Asia and Latin America while in Africa, Middle East and Europe it is still a new type of finance which can be improved. The other interesting point that emerges from the figure is that the regions with the highest poverty rate are Africa and South Asia. As we mentioned before the South Asia region is a pioneer region in terms of microfinance as well as a leader in using microfinance services as a tool to reduce poverty.

In the Fig. 2 we provide exclusively a closer look at developing countries to highlight the differences when compared to world countries. In the figure above we can see that when we moved from world analysis to developing countries the average of gross loan portfolio in some regions has increased in value. Namely, in case of South Asia and East Asia the average of microfinance loans volume is higher when compared with the previous Fig. 1. It is caused by precisely two countries which were excluded from the list of developing countries: Pakistan and Samoa. These countries, when included (as in the world analysis showed in the Fig. 1) are decreasing the average of Gross Loan Portfolio.

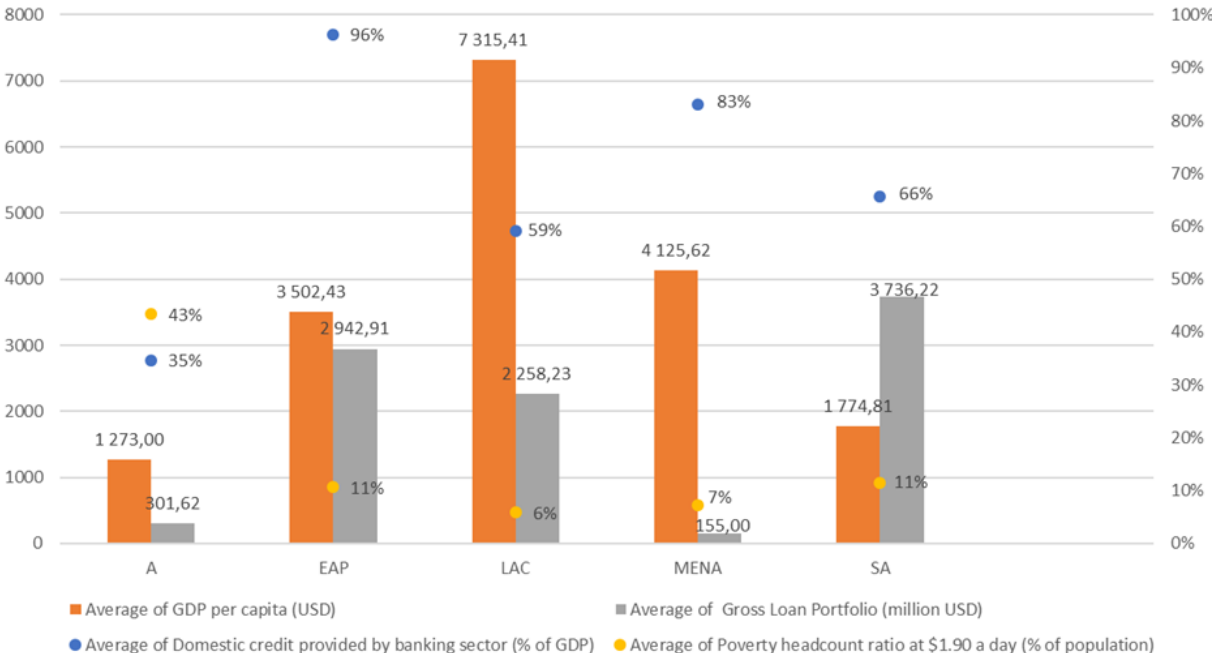

Fig. 2 – Average Values of Indicators Based on Regions – Developing Countries Analysis. Source: own research

Other indicators are not significantly changed in comparison with world averages, however, one of the regions (Eastern Europe and Central Asia) is excluded from the developing countries model as well because there are no developing countries.

**4.2 Preparation of data for analysis**

Before we start with regression analysis, we need to prepare our data and exclude the outliers from the model. In our model we found two outliers, namely India and Cambodia. These countries are outliers in terms of their values of Gross Loan Portfolio and therefore must be excluded.

### 4.3 Regression Analysis Output

The Multiple R or coefficient of correlation shown in the Tab. 3 represents the strength of relationship between the dependent (Poverty) and independent (GLP, GDP and Domestic Crd) variables. In fact, it shows that the strength of relationship is higher in case of developing countries (81.99%) compared to 75.97% of world countries.

Tab. 3 – Regression Statistics – Summary Output. Source: own research

Regression statistics		
<b>Multiple R</b>	World	0.75969479
	Developing countries	0.81993589
<b>R Square</b>	World	0.57713618
	Developing countries	0.67229486
<b>Adjusted R square</b>	World	0.5587508
	Developing countries	0.65137751
<b>Standard Error</b>	World	13.1133506
	Developing countries	12.3925582
<b>Observations</b>	World	73
	Developing countries	51

The coefficient of determination or R Square shows that in the model of world countries, 57.71% of variation of dependent variable around the mean is explained by independent variables the used linear model. In developing countries regression model is this value higher – 67.23% of variation of dependent variable is explained by the Domestic credit provided by banking sector, GDP per capita and gross loan portfolio. Standard Error explains how the data points are distributed above and below the regression trend line. Average distance of the observed values that do not fit the regression line is in case of developing countries 12.39, which is closer when compared to world countries where standard error is 13.11. The number of Observations is higher in world analysis as there are more countries included in observation than that in analysis of developing countries. According to the P-value which is seen in the Tab. 4 we can categorize the variables to those which have an impact on poverty and those which have no significant impact. When the P-value is lower than the alpha (0.05), the variable has a significant influence on dependent variable (Poverty). So, we reject the null hypothesis. In this regression model, the world analysis show that there is a significant relationship between GDP per capita and poverty. When we compare it with the model using data exclusively from developing countries, we found out that from the analysis comes out that all variables have an effect on the poverty level. These results show that although the GLP has no significant impact on poverty on the world level, there is a significant relationship between gross loan portfolio and poverty in developing countries.

Tab. 4 – ANOVA output in Regression Analysis. Source: own research

		<b>Coefficients</b>	<b>Standard Error</b>	<b>t Stat</b>	<b>P-value</b>
<b>Intercept</b>	World	136.1038	12.8508	10.5911	4.14E-16
	Developing countries	154.2118	13.7899	11.1829	7.68E-15
<b>Domestic crd</b>	World	-3.8626	2.1520	-1.7948	0.0770
	Developing countries	-7.8214	2.9935	-2.6127	0.0120
<b>GDP</b>	World	-13.1604	1.8028	-7.2990	3.79E-10
	Developing countries	-12.0560	2.0233	-5.9584	3.11E-07
<b>GLP</b>	World	-0.3235	0.7778	-0.4159	0.6788
	Developing countries	-1.7794	1.0664	-1.6686	0.0264

Generally, the impact of GDP per capita, GLP or Domestic credit on Poverty is significantly higher in developing countries than in world countries. Basically, the results show the following trend: the countries with higher GDP, GLP and domestic credit values tend to be countries with

lower poverty levels. Moreover, it denotes that the microfinance is an effective tool for poverty reduction in developing countries.

## 5 DISCUSSION AND CONCLUSIONS

Proving the impact of microfinance on the economy of developing countries is a very complicated task. Mainly, it is caused by the difficulty of data collection and because of the different other factors influencing each country's economic growth. However, the majority of recent studies focused on analysis of the microfinance effect on the macroeconomic development came to the conclusion that the microfinance influences mainly the poverty level of the developing countries as well as it played an important role in achieving other UN Millennium development goals. The results from the regression analysis used in the paper go along with the conclusions of these studies. To examine the contribution of microfinance to achievement of Millennium development goals we compared the results of various studies analysing the impact of microfinance on poverty, access of children to education, the improvement of the health of children and women and empowerment of women. The regional studies proved that there is certain connection between the microfinance and improvement in these areas. By enabling the access to financial services for the poor microfinance has earned the position of an important tool of reaching the Millennium development goals by the year 2015. Analysing the impact of the volume of microfinance loans and macroeconomic indicators on poverty was another aim of our paper. We observed 73 world countries and 53 developing countries, and we proved that there is a significant relationship between the variables. In case of the regression model of the world countries we found out that the countries with higher values of the domestic credit provided by banking sector and GDP tends to have lower poverty levels. However, in the developing countries model in addition to these variables there was proven an impact of gross loan portfolio on the poverty ratio where the countries with lower GLP values tend to struggle with higher poverty ratios. These results correspond with the conclusions of the recent study authored by Imai et al. (2012) and Prasad (2017). To determine the real level of microfinance impact on poverty is very difficult due to deficiency of relevant data and because the all other factors influencing the poverty level in developing countries that are hard to be included into analysis. Therefore, the results cannot be accurate rather it shows the overall trend of relationship between the microfinance and poverty. In the times of rapid increase of microfinance institutions in developing countries it is crucial to do more research that would reflect the real impact of microfinance activities in the long run and reduce its risks. To sum up, from the results of our regression analyses as well as from the conclusions of studies reported in the paper we can proclaim that the microfinance has a big potential in reaching the developing goals of the third countries such as poverty reduction, improvement of health or empowerment of women.

### References

- Agbola, F. W., Acupan, A., & Mahmood, A. (2017). Does microfinance reduce poverty? New evidence from Northeastern Mindanao, the Philippines. *Journal of Rural Studies*, 50, 159-171. doi: 10.1016/j.jrurs+tud.2016.11.005
- Balkenhol, B., & Guézennec, C. (2013). *Le microcrédit professionnel en France: quels effets sur l'emploi?* Paris: Centre d'Analyse Stratégique.
- Banerjee, A., Karlan, D., & Zinman, J. (2015). Six Randomized Evaluations of Microcredit: Introduction and Further Steps. *American Economic Journal: Applied Economics*, 7(1), 1-21. doi: 10.1257/app.20140287

- Barnes, C., Gaile, G., & Kibombo, R. (2001). *The Impact of Three Microfinance Programs in Uganda*. Retrieved from [https://pdf.usaid.gov/pdf\\_docs/PNACL035.pdf](https://pdf.usaid.gov/pdf_docs/PNACL035.pdf)
- Bateman, M., & Chang, H. J. (2014). The Microfinance Illusion. *SSRN Electronic Journal*. doi: 10.2139/ssrn.2385174
- Bédécarrats, F., & Lapenu, C. (2013). Assessing Microfinance: Striking the Balance between Social Utility and Financial Performance. In J. P. Gueyie, R. Manos & J. Yaron (Eds.) *Microfinance in Developing Countries*. London: Palgrave Macmillan. doi: 10.1057/9781137301925\_4
- CGAP (2002). Microfinance and the Millennium Development Goals. *Donors Brief No. 9*. Washington: Consultative Group to Assist the Poor. Retrieved from <https://www.cgap.org/sites/default/files/researches/documents/CGAP-Donor-Brief-Microfinance-and-the-Millennium-Development-Goals-Dec-2002.pdf>
- Chen, M., & Snodgrass, D. (2001). *Managing Resources, Activities, and Risk in Urban India*. Washington: Assessing the Impact of Microenterprise Services Retrieved from <http://citeseerx.ist.psu.edu/viewdoc/download?doi=10.1.1.464.3905&rep=rep1&type=pdf>
- Cheston, S., & Kuhn, L. (2002). *Empowering Women through Microfinance*. Retrieved from <http://www.academia.edu/download/5353418/empowerment.pdf>
- Copestake, J. (2014). Credible impact evaluation in complex contexts: Confirmatory and exploratory approaches. *Evaluation*, 20(4), 412-427. doi: 10.1177/1356389014550559
- Copestake, J., & Williams, R. (2011). *What is the impact of microfinance, and what does this imply for microfinance policy and for future impact studies?* Oxford: Oxford Policy Management.
- Drioadisuryo, R., & Cloud, K. (1999). Gender, Self-employment and Microcredit Programs: An Indonesian Case Study. *The Quarterly Review of Economics and Finance*, 39(5), 769-779. doi: 10.1016/S1062-9769(99)00028-9
- Dunford, C. (2006). *Evidence of Microfinance's Contribution to Achieving the Millennium Development Goals*. Paper presented at the Global Microcredit Summit, Halifax, Canada. Retrieved from <https://community-wealth.org/sites/clone.community-wealth.org/files/downloads/paper-dunford.pdf>
- Duvendack, M. (2010). Smoke and Mirrors: Evidence of Microfinance Impact from an Evaluation of SEWA Bank in India. *DEV Working Paper 24*. Retrieved from <http://citeseerx.ist.psu.edu/viewdoc/download?doi=10.1.1.175.988&rep=rep1&type=pdf>
- Duvendack, M., Palmer-Jones, R., Copestake, J. G., Hooper, L., Loke, Y., & Rao, N. (2011). *What is the evidence of the impact of microfinance on the well-being of poor people?* London: EPPi-Centre. Retrieved from [http://opus.bath.ac.uk/26940/1/Microfinance\\_2011Duvendack\\_report.pdf](http://opus.bath.ac.uk/26940/1/Microfinance_2011Duvendack_report.pdf)
- Ghosh, J. (2013). Microfinance and the challenge of financial inclusion for development. *Cambridge Journal of Economics*, 37(6), 1203-1219. doi: 10.1093/cje/bet042
- Gloukoviezoff, G. (2010). *L'exclusion bancaire. Le lien social à l'épreuve de la rentabilité, Le lien social*. Paris: Presses Universitaires de France.
- Gloukoviezoff, G., & Rebière, N. (2013). *Etude d'impacts des microcrédits personnels garantis*. Paris: 2G Recherche.

- Haile, H. B., Bock, B., & Folmer, H. (2012). Microfinance and female empowerment: Do institutions matter? *Women's Studies International Forum*, 35(4), 256-265. doi: 10.1016/j.wsif.2012.04.001
- Hashemi, S. M., Schuler, S. R., & Riley, A. P. (1996). Rural Credit Programs and Women's Empowerment in Bangladesh. *World Development*, 24(4), 635-653. doi: 10.1016/0305-750X(95)00159-A
- Imai, K. S., Gaiha, R., Thapa, G., & Annim, S. K. (2012). Microfinance and Poverty: A Macro Perspective. *World Development*, 40(8), 1675-1689. doi: 10.1016/j.worlddev.2012.04.013
- Imai, K. S., & Azam, M. S. (2012). Does Microfinance Reduce Poverty in Bangladesh? New Evidence from Household Panel Data. *Journal of Development Studies*, 48(5), 633-653. doi: 10.1080/00220388.2012.661853
- Karlan, D., & Goldberg, N. (2011). Microfinance evaluation strategies: Notes on methodology and findings. In B Armendáriz & M. Labie (Eds.), *The Handbook of Microfinance*. New Jersey: World Scientific. doi: 10.1142/9789814295666\_0002
- Khandker, S. (1998). *Fighting Poverty with Microcredit: Experience in Bangladesh*. New York: Oxford University Press. Retrieved from <http://documents.worldbank.org/curated/en/549951468768619206/pdf/multi-page.pdf>
- Littlefield, E., Morduch, J., & Hashemi, S. (2003). *Is Microfinance an Effective Strategy to Reach the Millennium Development Goals?* Washington: World Bank. Retrieved from <http://documents.worldbank.org/curated/en/982761468319745482/Is-microfinance-an-effective-strategy-to-reach-the-Millennium-Development-Goals>
- Ledgerwood, J. (1998) *Microfinance handbook: An institutional and financial perspective*. Washington: World Bank. doi: 10.1596/978-0-8213-4306-7
- Martinez, S. W. (2016). Effects of Microfinance Penetration Rates on Education Participation. *WWU Honors Program Senior Projects*. 21. Retrieved from [https://cedar.wvu.edu/wvu\\_honors/21](https://cedar.wvu.edu/wvu_honors/21)
- Miled, K. B. H., & Rejeb, J. E. B. (2015). Microfinance and Poverty Reduction: A Review and Synthesis of Empirical Evidence. *Procedia - Social and Behavioral Sciences*, 195, 705-712. doi: 10.1016/j.sbspro.2015.06.339
- MIX (2018). *Microfinance Information Exchange*. Retrieved from <https://www.themix.org/>
- MkKelly, B., & Dunford, C. (1999). Impact of Credit with Education on Mothers and Their Young Children's Nutrition: CRECER Credit with Education Program in Bolivia. *Freedom from Hunger Paper no. 5*. Retrieved from <http://www.microfinancegateway.org/sites/default/files/mfg-en-paper-impact-of-credit-with-education-on-mothers-and-their-young-childrens-nutrition-crecer-credit-with-education-program-in-bolivia-1999.pdf>
- MkKelly, B., & Dunford, C. (1998). Impact of Credit with Education on Mothers and Their Young Children's Nutrition: Lower Pra Rural Bank Credit with Education Program in Ghana. *Freedom from Hunger Paper no. 4*. Retrieved from [https://www.freedomfromhunger.org/sites/default/files/Ghana\\_Nutrition\\_Impact\\_Study\\_3-98-eng.pdf](https://www.freedomfromhunger.org/sites/default/files/Ghana_Nutrition_Impact_Study_3-98-eng.pdf)
- Prasad, A. (2017). Contribution of Microfinance in Achieving Millennium Development Goals: Evidences from Global Pool Data. *International Journal of Rural Management*, 13(2), 182-198. doi: 10.1177/0973005217725412

- Posso, A., & Athukorala, P. (2018). Microfinance and child mortality. *Applied Economics*, 50(21), 2313-2324. doi: 10.1080/00036846.2017.1394976
- Viswanath, P. (2018). Microfinance and the Decision to Invest in Children's Education. *International Journal of Financial Studies*, 6(1), Article 16. doi: 10.3390/ijfs6010016
- World Bank (2011). *World Development Report 2012: Gender Equality and Development*. Washington: World Bank. Retrieved from <https://siteresources.worldbank.org/INTWDR2012/Resources/7778105-1299699968583/7786210-1315936222006/Complete-Report.pdf>

### Contact information

#### **Ing. Marta Paula Bendelová**

Slovak University of Agriculture in Nitra, Faculty of Economics and Management  
Tr. A. Hlinku 2, 94976, Nitra, Slovak Republic  
E-mail: [xbendelovam@is.uniag.sk](mailto:xbendelovam@is.uniag.sk)  
ORCID: 0000-0003-0728-2816

#### **doc. Ing. Artan Qineti, Ph.D.**

Slovak University of Agriculture in Nitra, Faculty of Economics and Management  
Tr. A. Hlinku 2, 94976, Nitra, Slovak Republic  
E-mail: [artan.qineti@uniag.sk](mailto:artan.qineti@uniag.sk)  
ORCID: 0000-0003-4766-9601

#### **Ing. Martina Zaujecová**

Slovak University of Agriculture in Nitra, Faculty of Economics and Management  
Tr. A. Hlinku 2, 94976, Nitra, Slovak Republic  
E-mail: [xsoporova@is.uniag.sk](mailto:xsoporova@is.uniag.sk)  
ORCID: 0000-0001-8726-5009

doi: 10.7441/dokbat.2019.009

# THE EFFECT OF MFI PERFORMANCE INDICATORS ON POVERTY

*Marta Paula Bendelová, Artan Qineti, Martina Zaujecová*

## **Abstract**

In recent years, microfinance has become one of the commonly used word in academic research. Mainly it is caused by the fact microfinance has been set as an official development tool to reduce poverty by the United Nations and it has spread all over the world. However, the academic opinions on the effect of microfinance on the poor are still uncertain. In this paper we examined the performance of MFIs in 73 world countries and 53 developing countries. The regression analysis was used to find the effect of MFIs performance and sustainability indicators like ability to fund the loans by deposits, the cost per borrower, portfolios in risk or profitability on poverty. Moreover, we compared the results from the year 2009 with the year 2015. The results proved that the countries with higher values of growth in borrowers and cost per borrower tend to be the countries with the higher poverty ratios. On the other hand, the higher the profit over loan portfolio the lower the poverty level of the country. In other words, the microfinance is more attractive to the poor countries and therefore they experience higher growth in microfinance borrowers. Moreover, in 2015 they were able to mobilize more deposits and be less dependent on external funders both in world countries analysis and developing countries analysis. The countries where the MFIs are more profitable, the poverty level tends to be lower as the risk of serving the clients is lower.

*Keywords: microfinance, developing countries, microfinance institutions, regression analysis*

## **1 INTRODUCTION**

Generally, microfinance was set as an appropriate tool to reduce poverty by the United Nations. There are several studies that examined the effect of microfinance on poverty levels in developing countries. However, they often examined this relationship between microfinance and poverty from the quantitative point of view not qualitative. It means that they analysed how many MFIs operate in the developing countries and how many microfinance loans were provided and how it influenced the poverty levels in those countries. Performance and sustainability of banks studies are common in banking research (Freixas & Rochet, 2008). Since microfinance is type of banking (in small amounts), there is no doubt that efficiency and performance studies are now becoming one of the most analysed issue in Microfinance research (Mersland & Strøm, 2009). However, a main feature that distinguishes microfinance from ordinary banking services is that MFIs normally claim to have two basements – they want to serve poor clients (outreach) and in the same time they want to be financially sustainable. This was called by Morduch (2000) as the schism debate where the main question is if the providers of microfinance services are able to reach the poor customers and in the same time be financially sustainable. This debate has caught the attention of many researchers (Hermes, Lensink, & Meesters, 2011; Mersland & Strøm, 2010) and that is the reason why microfinance has become an interesting research area not only for researchers who are interested in microfinance, but for researchers and policy makers who are attracted by “hybrid organizations” and “social entrepreneurship” as well. Despite there are some scientific studies about microfinance performance that are already available, the research on MFI performance is still considered as a new field of research. There are many reasons why the performance research of MFIs is needed. Firstly, the fact that the target group for microfinance are poor and vulnerable people means that this market will soon become the world’s largest banking market in terms of number

of potential clients. Moreover, this number is expected to continue to increase (Mersland, 2013). Second, the microfinance institutions are hard to define. Nowadays, a lot of different organizations are providing microfinance services. What is considered as a good performance differs across different types of organizations (Mersland, 2009). Third, the microfinance institutions are changing – they offer today various types of banking services like insurance, savings, money transfers, etc. These changes make risk as one of the important performance indicators for MFIs. However, the MFIs has not changed only in terms of banking services provided - in the 1970s and 1980s were MFIs mostly financed by donors, today they are funded also by local depositors, stockholders, international lenders and bondholders. Due to this fact now, MFIs have to be careful also about so called lending margins which is a performance indicator that is not usually discussed in microfinance research. Today, when the more critical attitude to MFIs is applied, there is a higher demand for MFIs that could demonstrate a good performance. (Beisland et al., 2014).

## **2 THEORETICAL BACKGROUND**

### **2.1 Definition and history of microfinance**

Microfinance is defined as a tool for economic development whose target group are people with low income. This term is connected with providing of financial services to low-income people including those who are self-employed. These services usually consist of credit and savings, but sometimes there are also included payment services and insurance. Moreover, some microfinance institutions provide social development services like group formation, improvement of self-confidence and financial literacy and management skills training. Therefore, in the definition of microfinance is added both financial and social intermediation.

Microfinance is trying to reach people who are mostly self-employed, employers with low income from both rural and urban areas. These self-employers are generally vendors, traders, farmers or providers of some services (for example hairdressers). (Ledgerwood, 1999) Development Microfinance has its roots in the year 1974, when the professor at the university in Bangladesh lent \$27 to a group of poor people from rural areas. After that in 1983, this professor whose name is Muhammad Yunus founded the Grameen Bank to offer micro loans to low-income people. Despite the fact that Grameen Bank is reaching now people without any income, in the past their target group weren't the poorest people but those who were trying to run their own businesses lacking the required capital so that the bank could help them to get sustainable incomes. However, it was a long process where only 5% of poor people improved their income and escaped poverty. The lack of capital is only the one side of the problem. Poor health, education and natural disasters were serious issues to cope with. The offer of basic medical care and education of adults were the possible solutions for these problems. Regarding natural disasters, they began to find ways of helping their clients to survive the unexpected events. (Perkins, 2008) The microfinance has expanded so quickly that the year 2005 was dedicated to microcredit by UN which was expected to accelerate the effort to reduce the world poverty. This international year of microfinance was oriented on goals mainly to: (a) Promote the microfinance as an important contribution to the MFIs; (b) Increase the people's awareness and to reach better understanding of microfinance; (c) Create a system for access to financial services which is sustainable; and (d) Improve and build strategic partnerships and to support innovation.

In 2006, the founder of the Grameen Bank in Bangladesh, Mohammad Yunus, got the Nobel Prize for his efforts and the microfinance or microcredit expanded even more among the countries. It is now very popular tool to help low-income people not only in developing countries but also in countries in Europe. (Microfinanceinfo, 2005)



## **2.2 Risks of MFIs**

In general, for MFIs it is crucial to know the possible risks related to microfinance in order to avoid them. The institutions need to be aware of these risks, to analyse them and then to initiate arrangements to reduce them. There are four main areas of risk that are specific to MFIs: portfolio risk, ownership and governance, management, and “new industry.” (Berenbach & Churchill, 1997)

### **Risk from Supervision**

Generally, regulation and supervision done externally is essential for the financial system, however, none of these can do these activities as effectively as the financial institutions owners themselves. Therefore, there can possibly arise issues related to this control of performance. The problem is, that the MFI investors often do not behave in the same way as in the case of their usual investments because they are more oriented on the social objectives and it results in different standards applied. The regulators should encourage other institutions whose primal focus is on development to invest in activities of MFIs. In case of social organization that is considered as financial intermediary social objectives can become more prioritized than financial objectives. As a result, the real performance of intermediary is hardly determined and subsequently the work of regulators is made more difficult as the financial profile is not accurate. To success in arrangement between the MFI and social organization, the operations, MFI management and financial services supervision must be independent. Usually, the MFI is able to raise fund for the initial capital needs from the shareholders who are also founders of the institution. On the other hand, they may not be willing to additionally invest in the institution when necessary. Moreover, return of the investment can be a long process as the approval process takes often a long time. (Ledgerwood & White, 2006)

### **Risk from Management**

The management risks arise from the different management approaches that have effect on the way of providing financial products and services. The structure of a microfinance institution in developing countries is often decentralized and because of that, it allows the access to financial services directly at the location of providers and clients. As a result, the senior management must ensure the proper education, training and supervision over the lower management. The communication between the higher management and the lower one is crucial in order to achieve adoption of unified policies and actions. Moreover, the decentralization creates an environment where frauds can easily take place. Therefore, the regulators should require the high-quality management to reach better performance of the MFIs. (Goldberg & Palladini, 2010)

### **The risk resulting from the new industry**

The little competition of microfinance institutions in new markets can result in significant growth in their first years of operations. Therefore, the regulators should be precise in their supervisory activities and monitor the growth predictions carefully. Although, the microfinance industry is a new field, the design of financial products and services has been improving dramatically. However, sometimes the financial products and services are some kind of deviation from the original ones and they are not tested enough to be able to label them as safe option. Instead, the regulators should limit the new products and services accessible for the consumers. Moreover, the high amount of small transactions remains the main challenge of microfinance. Thus, the MFIs should be limited to quite simple financial products and services in order to be understood easily. (Berenbach & Churchill, 1997)

### 3 METHODS

Data for analysis were retrieved from official websites of institutions, namely, from the World Bank and Microfinance Information Exchange. Basically, we observed data from the year 2009 and 2015. The members of United Nations had committed to reach the goal of reducing poverty by the year 2015 and therefore we used this year to reflect the situation in the end of the period designated for reaching these goals. The year 2009 was used in order to provide an analysis from the year in the middle of the period to compare the results with the year 2015 and see the difference. The problem of inaccessibility of poverty data of some developing countries has been solved by using the most recent figure available to involve it into the 2015 analysis and in case of the year 2009 by choosing the data from the time period of 2005 to 2009. In the paper, the two groups of countries were analysed: the world and the developing countries. While in the world analysis, there were included 73 countries based on available data, in the developing countries model we excluded the non-developing countries which decreased the number of observations to 53 countries. The developing countries have been chosen in accordance with the UN list where the countries are categorized by their level of development. In both analyses we have divided the countries into groups according to regions as follows: (1) Africa; (2) Eastern Asia and Pacific; (3) Eastern Europe and Central Asia; (4) Latin America and Caribbean; (5) Middle East and North Africa; and (6) South Asia.

We have chosen the microfinance indicators which reflect not only the increasing trend of microfinance but also the performance of the microfinance institutions to ensure the deeper analysis of the “health” of the MFIs in different developing countries and the impact of these indicators on poverty. In particular, the following indicators were chosen in analyses: (a) **Poverty headcount ratio at \$1.90 a day** – is a percentage of population who live at less than \$1.90 a day; (b) **Growth in Borrowers** – measures the expansion of microfinance services as a percentage change in borrowers compared to the previous year; (c) **Deposits/Loan Portfolio** – represents the measure that shows the ability of microfinance institutions to fund provided loans from the deposits of clients. It is calculated as the voluntary deposits over gross loan portfolio; (d) **Cost per Borrower/GNI per capita** – is a ratio that measures the cost of serving the clients adjusted to the country’s income level. Basically, it is the operating costs per borrower over the gross national income per capita; (e) **Profit/Loan Portfolio** – refers to profit margin of microfinance institution calculated as a net income over the average loan portfolio and is similar to return on assets indicator; (f) **Portfolio at risk > 30 days** – measures the on-going quality of portfolio as a portfolio overdue for more than 30 days plus renegotiated portfolio divided by gross loan portfolio; and (g) **Borrowers/ Population** – represents the number of microfinance borrowers over population which express the share of microfinance clients as a percentage of country’s population.

For the evaluation of the performance of MFIs on the poverty levels of developing countries we used regression analysis. The aim of regression model is to characterize the relationship between the independent and dependent variables. It seeks the mathematical function that is called regression function or model that would express the relationship the best. We estimated following linear model:

$$Pov_i = \beta_0 + \beta_1 GiB_i + \beta_2 D/L_i + \beta_3 CpB/GNI_i + \beta_4 P/L_i + \beta_5 PAR_i + \beta_6 B/P_i \quad (1)$$

The formula represents linear relationship between the variables where the “Pov” means a poverty headcount ratio at \$1.90 a day; “GiB” is for the Growth in borrowers, “D/L” is Deposits/Loan portfolio indicator, “CpB/GNI” represents Cost per borrower/Gross national income, “P/L” is for Profit/Loan portfolio, “PAR” is Portfolio at risk for more than 30 days and “B/P” indicates the Borrowers over Population. We used similar variables as Mersland and Strøm (2014).

The hypotheses for our regression analyses were stated as follows:

H0 – there is no significant relationship between the variables

H1 – there is a significant relationship between the dependent and independent variables

The hypotheses were accepted or rejected by using the test where we compared the p-value with significance level  $\alpha = 0.05$ . When the p-value was lower than alpha, we accepted the H1 hypothesis and reject the null hypothesis. On the other hand, when the p-value was higher than 0.05, we rejected the H1 hypothesis and accept the H0 hypothesis.

## 4 RESULTS

### 4.1 The Effect of Microfinance Indicators on Poverty in 2009

#### Descriptive statistics for the Year 2009

In case of analysing the developing countries, we have skipped the Eastern Europe and Central Asia as there were no developing countries involved in the database. Moreover, from the EAP and SA regions were left out two countries, namely Samoa and Pakistan as they are not involved in the list of developing countries as well. Basically, we have chosen countries where microfinance institutions operate and report their performance to Microfinance Exchange Information (MIX) organization so that we could get the relevant data for our analysis.

Tab. 1 – Regions and number of countries. Source: own research

Region	N. of countries (World analysis)	N. of countries (Developing countries analysis)
Africa (A)	19	19
East Asia and Pacific (EAP)	6	5
Eastern Europe and Central Asia (EECA)	18	0
Latin America and Carribean (LAC)	17	17
Middle East and North Africa (MENA)	7	7
South Asia (SA)	6	5
Together	73	53

Tab. 2 describes the basic descriptive statistics of the dataset such as mean, median, standard deviation, minimum and maximum of each indicator used in our study. The median value of the indicators such as growth of borrowers and deposits over loan portfolio is higher in case of developing countries than in world countries in the year 2009.

Tab. 2 – Descriptive statistics for the year 2009. Source: MIX (2019)

Indicator		Mean	Median	Stand. deviation	Min	Max
Growth in Borrowers	World	30.39	19.84	35.88	-12.86	186.06
	Developing countries	32.47	20.17	38.45	-12.86	186.06
Deposits/Loan Portfolio	World	26.72	22.78	24.41	0.00	120.30
	Developing countries	28.55	24.56	25.14	0.00	120.30
CPB/GNI	World	17.66	11.88	17.24	1.73	73.33
	Developing countries	17.26	10.27	18.02	1.73	73.33
Profit/Loan Portfolio	World	-0.56	1.69	9.91	-33.26	24.23
	Developing countries	-1.53	1.24	10.92	-33.26	24.23
PAR>30 days	World	5.90	5.47	3.42	0.04	15.51
	Developing countries	6.58	5.97	3.54	0.04	15.51
Borrowers/ Population	World	2.36	1.31	3.08	0.00	14.70
	Developing countries	2.21	1.30	2.86	0.00	13.37
Poverty	World	18.93	9.2	21.68	0	72
	Developing countries	25.18	15	22.35	0.1	72

However, the performance of the MFIs in developing countries is worse than in the world countries as is seen in the median values of the profitability (Profit/Loan Portfolio) and risk measure (PAR>30 days). The ratio of borrowers over population is quite similar in both cases. What is more, the relatively high values of standard deviations and big differences between minimum and maximum show that we used a dataset with great variety of countries from different regions. The Fig. 1 shows the average performance of microfinance institutions by regions in world analysis. The highest deposits over loan portfolio ratio were in Africa region (41%) which means that in this region there are enough deposits to cover the loans of the borrowers. Therefore, in this region the MFIs are least dependent on the external sources of funding because deposits can cover the loans of borrowers.

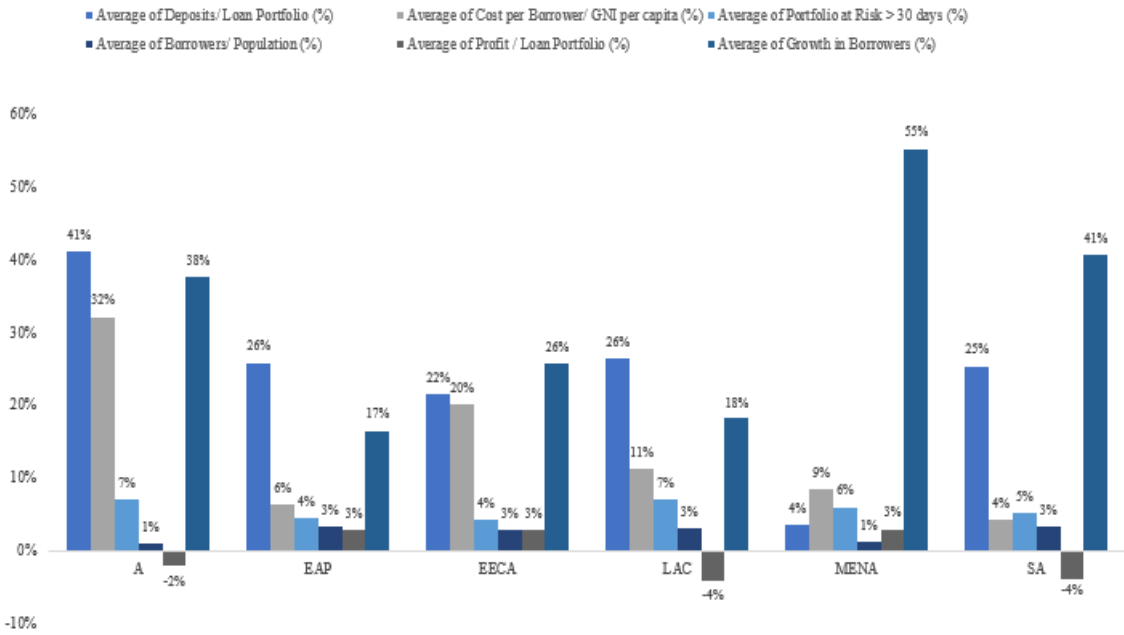

Fig. 1 – MFIs performance indicators by region - World countries. Source: MIX (2019)

On the other hand, in Africa region there is also the highest cost per borrower compared to their incomes (GNIs) and the clients are most likely to have their portfolio at risk more than 30 days. It follows, that although in this region there are enough depositors that can cover the loans of the borrowers, the efficiency indicators show that the MFIs in Africa region are struggling with the high cost and risk that arise from microfinance activities. The biggest average share of population involved in microfinance are in EAP, EECA, LAC and SA regions with the same average value of 3%. The regions whose MFIs were profitable in the year 2009 are EAP, EECA and MENA with 3% on average. In other regions were detected negative values in terms of their profitability, especially in LAC and SA region with -4 per cent. The biggest average growth of clients experiences mostly MENA (55%), SA (41%) and A (38%) regions.

**Preparation of Data for Analysis**

The data used for analysis must be freed from the outliers that affect the results undesirably because they are so different from the rest of the countries that they do not represent the sample. The main outliers were the following five countries: Cameroon, Venezuela, Montenegro, Uzbekistan and Jordan. In terms of developing countries, only Jordan and Venezuela were excluded from the dataset. The outliers could be explained by other factors that influence the variables such as political, economic or social that can have a strong impact on the different relationship values.

## Regression Output

In the Tab. 3 we can see the summary regression output expressing the significance of relationship between the microfinance indicators and poverty in 2009. The Multiple R or coefficient of correlation shows higher value in case of developing countries model (78.52%) compared to world model (67.69%) where the percentage represents the strength of relationship between the variables. The R Square or the coefficient of determination reflects that in case of world countries, 45.82% of variation of dependent variable (Poverty) around the mean is explained by independent variables (Microfinance indicators). However, the developing countries regression model has higher R Square, where the percentage is interpreted as 56.55% of variation of dependent variable is explained by microfinance indicators.

Tab. 3 – Regression statistics for poverty in relation with MFIs performance indicators. Source: own research

Regression statistics		
Multiple R	World	0.6769
	Developing countries	0.7852
R Square	World	0.4582
	Developing countries	0.6166
Adjusted R square	World	0.4049
	Developing countries	0.5655
Standard Error	World	17.0113
	Developing countries	14.6903
Observations	World	68
	Developing countries	52

Standard Error or average distance of the values that are not at the regression line is shorter in case of developing countries (14.69) compared to world model where standard error is 17.01. The P-values from the Tab. 4 express which variables have an impact on poverty.

Tab. 4 – ANOVA output in regression analysis. Source: own research

Indicators		Coefficients	Standard Error	t Stat	P-value
Intercept	World	-0.0528	5.7926	-0.0091	0.9928
	Developing countries	9.3802	5.7822	1.6223	0.1117
Growth in Borrowers	World	15.0745	6.6333	2.2726	0.0266
	Developing countries	14.6909	5.9800	2.4567	0.0179
Deposits/Loan Portfolio	World	22.6824	11.1639	2.0318	0.0465
	Developing countries	3.9635	89752	0.4416	0.2509
CpB/GNI	World	59.6088	12.4187	4.7999	0.0000
	Developing countries	85.4899	12.2871	6.9577	0.0000
Profit/Loan Portfolio	World	-19.4269	21.9424	-0.8854	0.3794
	Developing countries	-9.9431	20.2605	-0.4908	0.6260
PAR>30 days	World	21.5219	70.0154	0.3074	0.7596
	Developing countries	-46.8995	65.2341	-0.7189	0.4759
Borrowers/Population	World	-78.4966	70.9541	-1.1063	0.2729
	Developing countries	-58.3874	75.8882	-0.7694	0.4457

Whether the hypothesis that there is a relationship between the variable is true can be assessed by comparing the P-value with alpha (0.05). The regression output shows that the variables that have significant impact on poverty are Growth in borrowers and Cost per borrowers over GNI. In case of the world analysis there is a relationship between poverty and Deposits/Loan portfolio as well. Normally, we would expect the negative correlation between growth in borrowers and poverty. However, the results make sense when we take into account the reality that countries that experience higher growth of clients are usually poor countries where people need the access to financial services at most. Therefore, the higher the growth in borrowers the higher poverty

in the country. Another relationship could be interpreted as the higher the cost per borrower the higher poverty the countries experience. We can notice that in case of developing countries, the Cost per Borrower over GNI makes a higher increase in poverty than in case of world model. This could be a consequence of lack of access to financial services in developing countries and subsequently it means the higher costs for clients for these services. To interpret the results correctly we need to keep in mind that the regression model reflects the situation only in the year 2009 and so we cannot analyse the impact of growth in borrowers on poverty during a certain period of time. Moreover, the results may be affected by imperfection of the model used.

#### 4.2 The Effect of Microfinance Indicators on Poverty in 2015

To have a bigger picture of how the performance of microfinance institutions contributed to poverty reduction, we need to analyse the year by which the poverty goal should have been reached – the year 2015.

##### Descriptive Statistics of Data from the Year 2015

Before the application of regression model itself, we have to briefly describe the data from the year 2015 and how the situation has changed in comparison with the year 2009. The table below shows the basic functions that characterize the data used in analysis such as mean, median, standard deviation, minimum and maximum. As in the year 2009, we can see big differences between maximum and minimum in 2015 because we have chosen the same countries as in the previous case and therefore there remains the same great variety of countries from different regions. These countries vary in many ways, whether economically, politically or culturally and last but not least in their involvement in microfinance activities and thus it is reflected in average distance from the mean (standard deviation) as well as in difference between maximum and minimum.

Tab. 5 – Descriptive statistics for the year 2015. Source: MIX (2019)

Indicator		Mean	Median	Stand. deviation	Min	Max
Growth in Borrowers	World	0.40	0.04	2.53	-0.89	21.05
	Developing countries	0.60	0.06	2.94	-0.67	21.05
Deposits/Loan Portfolio	World	0.74	0.48	1.87	0.00	16.02
	Developing countries	0.87	0.59	2.17	0.00	16.02
CPB/GNI	World	4.82	2.54	5.19	0.26	26.72
	Developing countries	5.19	2.61	5.69	0.26	26.72
Profit/Loan Portfolio	World	0.62	1.70	6.19	-33.10	9.20
	Developing countries	0.46	1.90	7.09	-33.10	9.20
PAR>30 days	World	6.71	4.60	8.45	0.10	62.70
	Developing countries	6.48	4.20	9.12	0.10	62.70
Borrowers/Population	World	2.96	1.07	4.02	0.00	16.04
	Developing countries	2.93	1.02	4.01	0.02	14.87
Poverty	World	15.40	4.80	19.62	0.00	65.70
	Developing countries	20.59	12.60	20.75	0.00	65.70

In the Fig. 2 are compared the medians of microfinance indicators in 2009 and 2015 for better illustration of the differences between these two years. The borrower's growth has declined both in case of world and developing countries analysis. The reason for this decrease in client's growth could be that the initial growth of microfinance has been stabilized. However, the deposits over loan portfolio ratio has increased significantly and so we can say that the MFIs have become more sustainable and less dependent on external funds. In other words, they are more able to mobilize deposits in order to cover the loans. The other important change between the years 2009 and 2015 is the rapid decrease of costs of serving the borrowers (cost per borrower/GNI per capita). This trend reflects the increased ability of MFIs to decrease their cost and subsequently to reach more poor people in the regions.

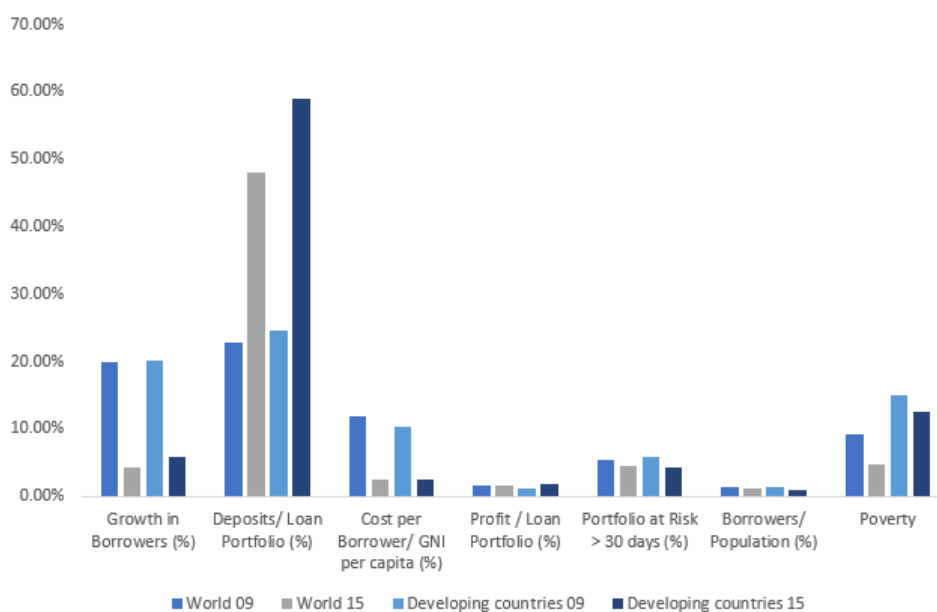

Fig. 2 – Comparison of medians 2009 and 2015. Source: MIX (2019)

Moreover, it encourages the rise of number of MFIs as it becomes more attractive for investors. The share of portfolios at risk for more than 30 years has decreased as well proving that the quality of loan portfolios has increased from the year 2009 to 2015. Furthermore, the significant decrease in poverty ratio only confirms the successful achievement of millennium development goals which were committed to be reached by the year 2015. The other indicators did not change significantly during the period.

### Preparation of Data for Regression Analysis

The regression analysis requires the data to be freed from outliers. These outliers affect the reliability of the model because of significantly different relationship between the dependent and independent variables compared to other countries. In this case, the countries which had too different values of growth in borrowers, deposits over loan portfolio or profit over loan portfolio that they had to be excluded are Mali, Yemen and Syrian Arab Republic. The differences in values could be explained by other factors that may have influence on diverse relationship between the variables such as political, economic or social. In addition, these countries are not politically stable and are often in war conflicts and therefore they do not represent accurately our sample group of countries.

### Regression model

After excluding the outliers from the model, the regression analysis could be applied. In the Tab. 10 we can see the output of regression statistics which is divided into two models: world and development countries model. Multiple R is higher in developing countries analysis (80.35%) compared to world analysis (72.84%) which indicates the stronger relationship between the variables. The R Square shows that in case of developing countries, 64.57% of variation of Poverty headcount ratio around the mean is explained by Microfinance indicators compared to 53.07% in world model. The Adjusted R Square explains that in case of world countries, 48.6% of variation of dependent variable is explained by the independent variables. In developing countries model is this percentage higher, namely 59.51%. Standard Error represents the average distance of the values that do not fit the regression line is lower in developing countries model (13.2) compared to world regression model where the value is 14.0.

Tab. 6 – Regression statistics for the year 2015. Source: World Bank (2015)

Regression statistics		
<b>Multiple R</b>	World	0.7284
	Developing countries	0.8035
<b>R Square</b>	World	0.5307
	Developing countries	0.6457
<b>Adjusted R square</b>	World	0.4860
	Developing countries	0.5951
<b>Standard Error</b>	World	13.9792
	Developing countries	13.1962
<b>Observations</b>	World	70
	Developing countries	49

In the ANOVA output shown in the Tab. 7 we can see the P-values from which we can analyse whether the variables have or have no impact on poverty. When the P-value is lower than alpha level (0.05), the relationship between the dependent (Poverty) and independent variables (Microfinance performance indicators) is significant. This regression output revealed that the variables which have significant effect on poverty are Growth in borrowers, Deposits/Loan portfolio, Profit/Loan portfolio and Cost per borrowers over GNI in both world and developing countries model.

Tab. 7 – ANOVA output for the year 2015. Source: own research

Indicators		Coefficients	Standard Error	t Stat	P-value
Intercept	World	3.0667	3.6023	0.8512	0.3978
	Developing countries	7.2603	4.0285	1.8022	0.0787
Growth in Borrowers	World	9.4003	2.8295	3.3222	0.0015
	Developing countries	12.0588	3.9914	3.0212	0.0043
Deposits/Loan Portfolio	World	14.1935	4.9366	2.8751	0.0055
	Developing countries	13.6044	6.0063	2.2650	0.0287
CPB/GNI	World	179.9014	44.5309	4.0399	0.0001
	Developing countries	194.1312	48.5845	3.9957	0.0003
Profit/Loan Portfolio	World	-82.3148	38.9921	-2.1111	0.0387
	Developing countries	-86.8040	40.1234	-2.1634	0.0362
PAR>30 days	World	-40.3306	34.8014	-1.1589	0.2509
	Developing countries	-39.8254	47.1031	-0.8455	0.4026
Borrowers/ Population	World	-38.5299	45.9800	-0.8380	0.4052
	Developing countries	-71.9391	53.1028	-1.3547	0.1828

Although, the positive correlation between the growth in microfinance clients and poverty was reduced comparing the years 2009 and 2015, it is still true that the higher the growth in borrowers the higher the poverty as the countries which are struggling with poverty are more likely to engage in microfinancing. The relationship between the ratio of Deposits/Loan portfolio and Poverty shows that the countries with higher poverty rates are better at mobilizing the deposits and are less dependent on funding from external parties. Furthermore, the results reflect the influence of Cost per borrower on Poverty ratio. Usually, the countries with higher cost of serving borrower are the countries with higher poverty rates. Furthermore, in the regression models from the year 2015 comes up another significant influencer of poverty rate – the profit over loan portfolio which had no significant effect on poverty in 2009. The results show that the countries with the higher MFI profit margin are the countries where the poverty ratio is smaller.



## 5 DISCUSSION AND CONCLUSIONS

The paper was focused on analysing of the impact of MFI performance indicators on the poverty levels of both developing and world countries in order to highlight the differences between them. Moreover, the paper includes analyses from the year 2009 as well as 2015 to compare the different years in the time period during which the countries worked on the achievement of Millennium development goals – where one of the goals was to reduce poverty. We have chosen the most relevant microfinance indicators, namely, the growth in borrowers, deposits over loan portfolio, profit over loan portfolio, borrowers as a percentage of population, cost per borrower adjusted to the national incomes and the percentage of portfolios at risk for more than 30 days. As dependent variable we have chosen poverty. By using regression analysis, it was proven that some of the microfinance performance indicators have a significant effect on poverty ratio in developing countries. Moreover, the effect of the microfinance indicators was stronger in the year 2015 than in 2009. The regression model from the year 2009 proved that the higher the growth of borrowers and cost per borrower the higher the poverty level of observed countries. In other words, the countries with the highest growth of borrowers are the poorest countries. Furthermore, this fact points out that the target market of microfinance are poor people that would not have otherwise the access to financial services. The results of the regression analysis from the year 2015 has shown that the number of microfinance performance indicators that have an impact on poverty has increased. The significant relationship between the variables was proven for the growth in borrowers, deposits over loan portfolio, cost per borrower and profit over loan portfolio.

### References

- Beisland, L. A., Mersland, R., & Randøy, T. (2014). Transparency and disclosure in the global microfinance industry: Implications for practice and policy makers. In J. Forssbaeck and L. Oxelheim (Eds), *The Oxford Handbook of Economic and Institutional Transparency*. New York: Oxford University Press.
- Berenbach, S., & Churchill, C. (1997). *Regulation and Supervision of Microfinance Institutions: Experiences from Latin America, Asia and Africa*. Retrieved from <https://www.microfinancegateway.org/library/regulation-and-supervision-microfinance-institutions-experiences-latin-america-asia-and>
- Cull, R., Demigüç-Kunt, A., & Morduch, J. (2007). Financial performance and outreach: A global analysis of leading microbanks. *The Economic Journal*, 117(517), 107-133. doi: 10.1111/j.1468-0297.2007.02017.x
- Freixas, X., & Rochet, J. C. (2008). *Microeconomics of Banking*. London: MIT Press.
- Goldberg, M., & Palladini, E. (2010). *Managing Risk and Creating Value with Microfinance*. Washington D.C.: The World Bank.
- Hermes, N., Lensink, R., & Meesters, A. (2011). Outreach and efficiency of microfinance institutions. *World Development*, 39(6), 938-948. doi: 10.1016/j.worlddev.2009.10.018
- Ledgerwood, J. (1999). *Microfinance Handbook: An Institutional and Financial Perspective*. Washington D.C.: The World Bank.
- Ledgerwood, J., & White, V. (2006). *Transforming Microfinance Institutions: Providing Full Financial Services to the Poor*. Washington D.C.: The World Bank.
- Mersland, R. (2009). The cost of ownership in micro-finance organizations. *World Development*, 37(2), 469-478. doi: 10.1016/j.worlddev.2008.03.006

- Mersland, R. (2013). Market opportunities for microfinance institutions. *Enterprise Development & Microfinance*, 24(4), 282-294. doi: 10.3362/1755-1986.2013.027
- Mersland, R., & Strøm, R. Ø. (2008). Performance and trade-offs in microfinance organizations: Does ownership matter? *Journal of International Development*, 20(4), 598-612. doi: 10.1002/jid.1432
- Mersland, R., & Strøm, R. Ø. (2009). Performance and governance in microfinance institutions. *Journal of Banking & Finance*, 33(4), 662-669. doi: 10.1016/j.jbankfin.2008.11.009
- Mersland, R., & Strøm, R. Ø. (2010). Microfinance mission drift? *World Development*, 38(1), 28-36. doi: 10.1016/j.worlddev.2009.05.006
- Mersland, R., & Strøm, R. Ø. (2014). *Microfinance Institutions: Financial and Social performance*. Hampshire: Palgrave Macmillan.
- Microfinanceinfo. (2005). *History of Microfinance*. Retrieved from <http://www.microfinanceinfo.com/history-of-microfinance/>
- MIX (2019). *Microfinance Information Exchange database*. Retrieved from <https://www.themix.org/>
- Perkins, A. (2008, June 3). A Short History of Microfinance. *The Guardian*. Retrieved from <https://www.theguardian.com/katine/2008/jun/03/livelihoods.projectgoals1>
- World Bank (2019). *The World Bank database*. Retrieved from <https://www.worldbank.org/>

## Contact information

### **Ing. Marta Paula Bendelová**

Slovak Agricultural University in Nitra, Faculty of Economics and Management  
Tr. A. Hlinku 2, 94976, Nitra, Slovak Republic  
E-mail: [xbendelovam@is.uniag.sk](mailto:xbendelovam@is.uniag.sk)  
ORCID: 0000-0003-0728-2816

### **doc. Ing. Artan Qineti, Ph.D.**

Slovak Agricultural University in Nitra, Faculty of Economics and Management  
Tr. A. Hlinku 2, 94976, Nitra, Slovak Republic  
E-mail: [artan.qineti@uniag.sk](mailto:artan.qineti@uniag.sk)  
ORCID: 0000-0003-4766-9601

### **Ing. Martina Zaujecová**

Slovak Agricultural University in Nitra, Faculty of Economics and Management  
Tr. A. Hlinku 2, 94976, Nitra, Slovak Republic  
E-mail: [xsoporova@is.uniag.sk](mailto:xsoporova@is.uniag.sk)  
ORCID: 0000-0001-8726-5009

doi: 10.7441/dokbat.2019.010

# DEFINING FINANCIAL RISK: A REVIEW OF APPROACHES

*Lucie Brabcová*

## **Abstract**

Despite numerous researches and publications being focused on financial risk management, by now there is no generally accepted definition of financial risk nor its taxonomy. The aim of this paper is to suggest upon a discussion the definition of financial risk along with its taxonomy. The methodology used in this paper is a method of induction over literature analysis and empirical data quantitative research. The literature and empirical review are placed on the same level as two complementary parts of the research, providing different views to the discussion. A literature review is performed on two research questions asking how authors define financial risk and how they classify its different types. The third research question, answered by empirical review, asks how companies classify financial risk by analysis of financial statements. As a first result, financial risk is defined as a risk of a loss caused by unfavourable change on financial markets as well as poor management of financial assets and liabilities. As a second result, the accepted financial risk taxonomy is determined as follows: interest rate risk, foreign exchange risk, commodity risk, stock risk, credit risk and liquidity risk, while the first four risk classes shall be considered as sub-categories of market risk and the last two classes as results of poor financial management. The results of this paper are intended to open expert discussion on financial risk definition and taxonomy, as well as to build a framework for further research on risk, solvency and liquidity management.

*Keywords:* risk, financial risk, risk management, market risk, credit risk, liquidity risk

## **1 INTRODUCTION**

In the business world there are wide ranges of risks that influence the company performance. Companies are supposed to manage these risks effectively to prevent or at least decrease their impact. The first step to successful risk management is identifying the risk types the company is facing. However, by now there is no generally accepted definition of financial risk, not even any taxonomy clearly distinguishing which risks shall be considered as financial and which not. The opinions of multiple authors vary significantly which is why a further research is necessary.

The aim of this paper is to suggest upon a discussion the definition of financial risk along with its taxonomy. The result of this research is intended to be a prerequisite part of a further research project (a dissertation) regarding financial risk, solvency and liquidity management.

## **2 METHODOLOGY**

The methodology used in this paper places literature review and empirical research side by side in a method of induction over literature analysis and empirical data quantitative research.

Firstly, a literature review is performed on two research questions: (1) How do authors define financial risk?; and (2) How do authors classify different types of financial risk? Each research question builds a separate chapter of this paper. At the end of every chapter there is a discussion over the other authors' opinions, evaluating the presented approaches and formulating own definition and classification, or agreeing with a previously presented opinion. The outcome of this discussion is also presented by a matching review in a tabular form where the suggested risk taxonomy is presented and compared to the previously analysed literature.

The literature review and related discussion is followed by analysis of financial statements of a selected companies' sample. The purpose of this analysis is to obtain understanding of which types of risk companies themselves consider being facing to. The third research question is therefore: (3) How do companies classify financial risk?

A potentially expected research question "How do companies define financial risk?" is not set as the companies are not requested by the International Financial Reporting Standards to define financial risk as a term. The findings of empirical review are again compared with the author's suggested financial risk definition and taxonomy and commented.

### **3 FINANCIAL RISK**

Despite ongoing discussions of researchers, the general concept and definition of risk itself is not yet defined in a generally accepted way (Sweeting, 2011; Marek, 2010; Hubbard, 2014; Malz, 2011). Marek (2010) presents five research questions for the general research of risk questioning the connection of risk and uncertainty, risk outcome situations (both positive and negative or solely negative), etc. However, this research direction is not in scope of this paper. The definition supported by the author and accepted for use in this paper is Hubbard's (2014) definition of risk, which is "a state of uncertainty where some of the possibilities involve a loss, catastrophe, or other undesirable outcome". This definition comprises the phenomenon of uncertainty, which is according to Hubbard (2014) "the lack of complete certainty, that is, the existence of more than one possibility. (...)" Descending one level down, the range of risks touches all the spheres of business and therefore they can be classified into different classes, such as enterprise risk, financial risk, operational risk and many others. This paper concentrates primarily on financial risk.

The question is, what is a financial risk? Where is the thin line between "pure" financial risk and general business risk with financial consequences? Is financial risk only the risk that arises from changes on capital markets, or any kind of risk that impacts the financial position of the company? And finally, is it really a risk by itself, or just a consequence of any other risk?

#### **3.1 Literature Review: Financial Risk**

The first part of the discussion concerns financial risk as such and its definition. A literature review has been performed and the most relevant findings were critically assessed.

Surprisingly, not many authors work with the definition of financial risk. In numerous publications there can be found definitions and opinions on general understanding of risk, but only very few authors step one level down to set a definition of financial risk as well.

Although Malz (2011) does not define financial risk directly, he formulates a difference between risk management and financial risk management by means of narrowing its context to financial assets and liabilities.

Horcher (2005) does not define financial risk either, but he describes how it arises. In his opinion, it is via "transactions of a financial nature, including sales and purchases, investments and loans, and various other business activities, legal transactions, new projects, competitors", or weather. In contrary, his definition of financial risk management is "a process to deal with the uncertainties resulting from financial markets". This is in line with his further financial risk taxonomy (discussed later in the paper) where he classifies the types of "major market risk" under chapter header "Identifying major financial risks". This discrepancy allows us to summarize that financial risk = market risk.

Not even Allen (2012) defines financial risk. The definition can yet be derived from his approach to financial risk management which “makes active use of trading in liquid markets to control risk”. In addition, he clearly concludes that operational risk does not fall into the financial risk category as the “operational risk is virtually all risk that cannot be managed through the use of liquid markets”.

Cooper (2004) presents a full definition of financial risk. As a financial risk can be considered “an unfavourable trend or change on an individual financial market (e.g. foreign exchange rates or interest rates movements) or a general unfavourable financial market development”.

### **3.2 Discussion: Financial Risk**

At the end, all the above presented opinions turn on the financial market in diverse ways. Malz (2011), Allen (2012) and Cooper (2004) mention solely financial markets while elaborating the financial risk or its management, Horcher (2005) though adds a supplementary risk base by including also factors outside of financial market. These factors are based on both company decisions and activities, and external factors. Opening a discussion with this opinion and Allen’s opinion, that clearly concludes these risk types could not be managed on liquid markets and thus they are operational, the author agrees with strict separation of financial and operational risk, although both risks have impact to financial performance of the entity (Allen, 2012). The financial risk is expected to be managed by the finance, or specifically, treasury department of the company, while the operational risk shall be managed by the relevant departments such as supply chain, legal etc. Another view to support this point is the generally accepted division of the Profit and Loss statement, being divided into result from operations, including outcomes from operational risk exposure, and financial result, including interest, FX gains and losses etc., resulting from financial risk exposure. This practical view is however debatable when credit risk is in question.

Cooper’s (2004) financial risk definition is in agreement with the previously accepted general risk definition by eliminating the positive outcomes of the risk. To conclude, the financial risk definition further used in this paper is as follows: Financial risk is risk of a loss caused by unfavourable change on financial markets as well as poor management of financial assets and liabilities.

## **4 FINANCIAL RISK TAXONOMY**

As there is yet no rigid taxonomy of financial risk, the authors classify them in various ways. It is evident that each author has a subjective feeling for the risk as some of the risk types are not considered as financial and vice versa. Below is an illustration of different opinions on the financial risk categorization.

### **4.1 Literature Review: Financial Risk Taxonomy**

Malz (2011) considers as financial risks the following: market risk, credit risk, liquidity risk, model risk, operational risk, legal risk, reputational risk and systemic risk. Most of these risks are further divided into subcategories. Although the whole taxonomy is very complex, it does not mention changes in interest rates nor foreign exchange rates, however, they are probably intended to be part of market risk. An interesting point is made by dividing the liquidity risk into two parts – market liquidity risk and funding liquidity risk; while the first covers the current market situation, the latter describes the entity’s own credit situation. The difference between market risk and market liquidity risk arises from the changes in market prices (market risk) on one side and the market depth (market liquidity risk) on the other side.

Sweeting's (2011) taxonomy concerns all the risks and not just financial risks that are not defined either. His only comment, which can be understood as a definition of financial risk, is relevant to financial institutions, which are the main point of interest of his publication. He notes that "market risk tends to affect the assets and financial risk the liabilities". The focus on financial institutions also transfers to the risk taxonomy. These risks are: market and economic risk, interest rate risk, foreign exchange risk, credit risk, liquidity risk, systemic risk (further divided), demographic risk, non-life-insurance risk and operational risks (further divided into business continuity risk, regulatory risk, technology risk, legal risk, model risk, reputational risk and more).

Horcher (2005) classifies the market / financial (referring to above discussed wording) risk into the following groups: foreign exchange risk, interest rate risk, commodity price risk, equity price risk (major market risks), credit risk, operational risk, liquidity risk, systemic risk (other financial risks). Schönborn (2010) divides financial risk into default risk, market risk, liquidity risk and operational risk, while market risk is further divided into interest rate risk, equity risk, currency risk and commodity risk. Allen (2012) does not directly classify the financial risk types, but from the structure of his book and chapters labeling is evident the connection to the financial market. His financial risk taxonomy is as follows: model risk, spot risk, forward risk, vanilla options risk, exotic options risk, credit risk and counterparty credit risk. Although liquidity risk is declared as one theme of the book, it is mentioned throughout the book, but not elaborated as a separate topic. In Hampton's (2011) opinion the financial risks are linked to production, marketing, cash flows, compliance, and technology and business disruption. The detailed division of risks related to cash flows contains organizational cash flows, key initiative cash flows, capital structure cash flows, credit cash flows and investment cash flows.

Christoffersen (2003) classifies financial risk as: market risk, liquidity risk, operational risk, credit risk and business risk. In his view, market risk is "a risk to a financial portfolio from movements in market prices such as equity prices, foreign exchange rates, interest rates, and commodity prices", whereas business risk covers the changes in business plan variables. Skoglund and Chen (2015) challenge the traditional view on financial risk (categorised as market risk, credit risk, liquidity risk and other risks). They prefer following the trend of overall analysing all the potential risks affecting the business line without any artificial classification to elementary risk types. They also present an idea that some risks have their prerequisites, typically liquidity risk, being a consequential one. Cooper's (2004) understanding of financial risk classification is: financing risk, liquidity risk, foreign exchange risk, interest rate risk, commodity risk, counterparty risk, equity risk and other. He labels these risks as treasury-related.

The taxonomy of typical financial risk types is also part of International Financial Reporting Standards. In paragraph 32 of IFRS 7 (2005) are suggested the risk categories that are expected to be reported: "These risks typically include, but are not limited to, credit risk, liquidity risk and market risk". The individual risk categories are defined in Appendix A (Defined terms) of IFRS 7 as follows: (a) **Credit risk**: The risk that one party to a financial instrument will cause a financial loss for the other party by failing to discharge an obligation; (b) **Liquidity risk**: The risk that an entity will encounter difficulty in meeting obligations associated with financial liabilities that are settled by delivering cash or another financial asset; (c) **Market risk**: The risk that the fair value or future cash flows of a financial instrument will fluctuate because of changes in market prices. Market risk comprises three types of risk: currency risk, interest rate risk and other price risk; (d) **Currency risk**: The risk that the fair value or future cash flows of a financial instrument will fluctuate because of changes in foreign exchange rates; (e) **Interest rate risk**: The risk that the fair value or future cash flows of a financial instrument will fluctuate because of changes in market interest rates; and (f) **Other price risk**: The risk that the fair value

or future cash flows of a financial instrument will fluctuate because of changes in market prices (other than those arising from interest rate risk or currency risk), whether those changes are caused by factors specific to the individual financial instrument or its issuer or by factors affecting all similar financial instruments traded in the market. The illustration of expected risk disclosure in accordance with IFRS 7 is presented in Fig. 1 below.

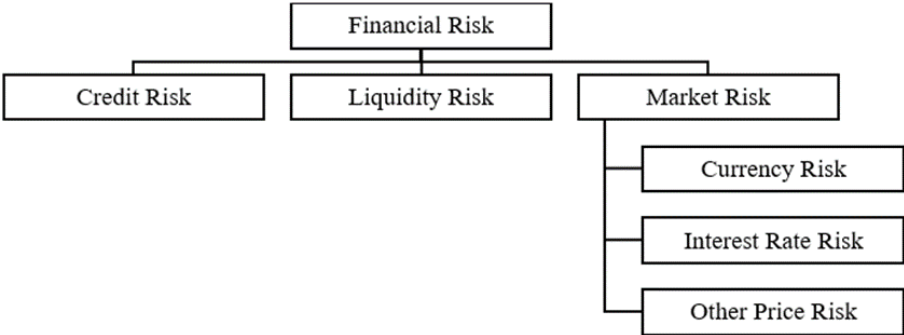

Fig. 1 – Financial risk taxonomy. Source: IFRS 7 (2005)

**4.2 Discussion: Financial Risk Taxonomy**

The collected literature review presents very different opinions on the financial risk classification, partly because some of the authors include the risk types which are by the above stated financial risk definition considered as operational risks. As decided in Chapter 3, the operational risk subcategories shall be eliminated from further research. The financial risk taxonomy used in the next research is derived from the above accepted financial risk definition.

**Risk of a loss caused by unfavourable change on financial markets is represented by the risk of changes in market interest rates, foreign exchange rates and commodity prices.**

Changes in commodity prices are debatable and by taking different point of view they could be classified as operational risk. However, the author shares the above cited Allen’s approach of controlling the financial risk by trading on liquid markets (Allen, 2012). Commodities are often hedged by commodity derivatives, which is also why the commodity risk is classified as financial risk in this paper.

**Poor management of financial assets and liabilities is represented by liquidity risk and credit risk.**

This classification is then compared with the literature review. The innovative approaches of Allen (2012), Hampton (2011) and Skoglund and Chen (2015) are not included in the below table (Tab. 1) as their categories are based on entirely different approaches.

All the authors, whose approaches are summarised in the table, agree on credit risk and liquidity risk. This is a surprising result as credit risk does not fully conform with the approach of financial risk being connected to the financial market, which looked to be prevailing in Chapter 3. The controversy in liquidity risk is noted by Skoglund and Chen (2015) who call this risk consequential. The author fully agrees with this objection and although the liquidity risk is a part of the classification, it requires a further research of its causes and triggers. The interest rate, foreign exchange and commodity risk is in publications of some authors hidden in the term “market risk”. In Tab. 1, the “x” sign is used in case the author clearly classifies the respective risk as financial. The “market” comment is used when the author mentions the specific risk as financial, but at the same time he categorizes it as market risk subcategory of financial risk. If there are brackets used in “(market)”, the author mentions market risk only, but from the context it can be understood the individual risk is part of the market risk subcategory.

Tab. 1 – Literature review summary. Source: own research

Author, year	Interest Rate risk	Foreign Exchange risk	Commodity risk	Credit risk	Liquidity risk
Malz (2011)		(market)		x	x
Sweeting (2011)	x	x		x	x
Horcher (2005)	x	x	x	x	x
Schönborn (2010)	market	market	market	x	x
Christoffersen (2003)	market	market	market	x	x
Skoglund, Chen (2015)		(market)		x	x
Cooper (2004)	x	x	x	x	x
IFRS 7 (2005)	market	market	(market)	x	x

For this stage of research, it can be concluded that the classification of financial risks is: interest rate risk, foreign exchange risk, commodity risk, credit risk and liquidity risk.

## 5 EMPIRICAL REVIEW: FINANCIAL RISK TAXONOMY

To supplement the theoretical review with another point of view, the empirical review follows. The purpose of this empirical review is not to confirm or disprove the results of literature review, but to present an additional sight.

### 5.1 Empirical Review Methodology

The financial risk taxonomy will be studied on a sample of Czech consolidated companies reporting in accordance with International Financial Reporting Standards. The sample selection methodology is as follows: **(1) Downloading a list of entities that are expected to report under IFRS.** Selecting a single reporting base is important to eliminate discrepancies caused by different requirements imposed by different reporting systems. According to the Czech regulation, these are (not limited to) issuers whose securities are admitted to trading on a regulated market. The list is available on the Czech National Bank website ([www.cnb.cz](http://www.cnb.cz)). This sample contained 122 records as of 2nd August 2019; **(2) Selecting the companies with company number available.** This number is a legal identificatory and allows downloading the financial statements online from the official Czech Ministry of Justice website that includes Czech business register. This sample contains 102 records. **(3) Selecting the companies with consolidated financial statements available from the Justice website.** The choice of selecting consolidated financial statements only is driven by a wider research context focusing on international holdings as well as the fact that risks are usually managed centrally on a group level. Finally, individual companies of a group can be operating in different fields facing different risks and analysing only one part would not give a complete picture. This sample contained 40 records as of 2nd August 2019; and **(4) Selecting the companies whose consolidated financial statements are prepared in accordance with IFRS.** This sample contains 40 records (all the above filtered consolidated statements are prepared in accordance with IFRS as assumed in step 1).

Out of the sample of 40 financial statements, 31 are relevant to year 2018 and 9 to year 2017. The sample contains varied range of business segments, with highest proportion of banks, investment funds and other financial institutions (37.5%, 15 companies), followed by energetics (22.5%, 9 companies). The rest of the sample is represented by railway, machine manufacturing, telecommunication, food manufacturing, accommodation and more, always with the proportion equal to or less than 10% of the sample. No elimination based on company type was made. The reason for not doing so was the fact that the financial risk is general enough term for all the business sectors; for example, manufacturing companies can face interest rates risk as well as banks. As Van Deventer, Imai and Mesler (2013) mentioned in their publication,



“This [risk management] definition knows no boundaries in terms of the nature of the institution”. However, for research aimed to quantify the risk impact, alternatively research focused on a specific risk, it would be desirable to consider differences in business sectors (banks and financial institutions at a minimum). On the selected sample is performed examining the financial risk categories reported by the companies. The information about financial risk classification was extracted from the financial statements. Frequency of financial risk types was examined with further split to financial risks identified in Chapter 3 and additional financial risks.

**5.2 IFRS 7 Disclosure Requirements**

Paragraph 31 of IFRS 7 (2005) requires the entities to “disclose information that enables users of its financial statements to evaluate the nature and extent of risks arising from financial instruments to which the entity is exposed at the end of the reporting period”. For definition of financial instrument, the IFRS 7 standard refers to the previous standard IAS 32 (2003). As a financial instrument, IAS 32 (2003) defines “any contract that gives rise to a financial asset of one entity and a financial liability or equity instrument of another entity”. However, the purpose of this paper is not to assess compliance with IFRS 7. The purpose of comparing the theoretical approach with the empirical part is to observe the financial risks as understood by companies.

**5.3 Empirical Review Findings and Discussion**

From the financial statements of studied companies was extracted the classification of financial risks and their distribution was reviewed. In Tab. 2 is summarised the distribution of the risk types classified as financial in Chapter 3 to answer the question how many companies (absolutely and relatively) agrees with the suggested financial risk classification.

Tab. 2 – Level of empirical accordance with pre-classified financial risks. Source: own research

Risk Type	Interest Rate risk	Foreign Exchange risk	Commodity risk	Credit risk	Liquidity risk
Reported in companies	38	39	10	37	38
	95 %	98 %	25%	93 %	95 %

Tab. 2 provides an empirical agreement with the pre-classified categories as the percentages rise above 90 % with an exception of commodity risk. However, this type of risk is relevant only for specific business sectors where is an excessive need for commodities such as electricity, gas, sugar etc. In line with the defined financial risk classification, it is expected the commodity risk is hedged on a financial market to be considered financial.

The conclusion supported by Tab. 2 is not to remove any risk type from the pre-defined financial risk classification.

However, as stated before, the aim of the analytical review was not to confirm the literature review findings, but to prepare a base for further adjustments to the pre-set classification. In Tab. 3 are mentioned the examples of another risks the companies reported. The list is not complete as in many cases the companies did not define the risks as financial and were reporting the risks that should in the author’s opinion be classified as sub-category of operational risk.

Tab. 3 – Additional risks identified from the empirical review. Source: own research

Price risk	Market risk (parent category)	Market risk (separate)	Operational risk	Compliance risk	Stock risk
7	25	8	9	6	12
18%	63%	20%	23%	15%	30%

In Tab. 3, there is doubled the class of market risk, once as a parent category and in another case as a separate category. This split is to illustrate the number of companies who specified

market risk and its sub-classification (i.e. interest rate risk) and companies who specified market risk only without providing any additional split. The market risk is not further discussed as it is understood as parent category of the previously discussed (relevant) risks from Tab. 2.

Tab. 3 provides the desired additional view to the financial risk classification possibilities. When disregarding the market risk, the highest percentage of occurrence has the stock risk. Stock risk represents the changes in market value of stocks the company has invested to in purpose of further trading (thus not creating a business combination). As long as the company does not sell these stocks, this risk results in unrealized gains and losses, which are anyway considered as a financial result. The price risk is very similar to previously discussed commodity risk. The difference in these two risk types is understood as the factor of mitigating the risk by trading on financial markets. The conclusion supported by Tab. 3 is to add the stock risk into the pre-defined financial risk classification.

Adding the empirical review results to the preliminary concluded financial risk classification, the accepted financial risk taxonomy is as follows: interest rate risk, foreign exchange risk, commodity risk, stock risk, credit risk and liquidity risk, while the first four risk classes shall be considered as sub-categories of market risk and the last two classes as results of poor financial management.

## 6 CONCLUSION

Despite numerous researches and publications being focused on financial risk management, by now there is no generally accepted definition of financial risk nor its taxonomy. The aim of this paper was to suggest upon a discussion the definition of financial risk along with its taxonomy.

The methodology used in this paper placed literature review and empirical research side by side in a method of induction over literature analysis and empirical data quantitative research. A literature review was performed on two research questions asking how authors defined financial risk and how they classified its different types. The literature review and related discussion was followed by analysis of financial statements of a selected companies' sample in order to obtain understanding of which types of risk companies themselves consider being facing to. The third research question therefore asked how companies classified financial risk.

The first part of literature review focused on financial risk definition. The subsequent discussion resulted in respecting the influence of changes in financial markets, combined with preference of a strict separation of financial and operational risk, and eliminating the possible positive outcomes of the risk. Financial risk was defined as a risk of a loss caused by unfavourable change on financial markets as well as poor management of financial assets and liabilities.

The second part of literature review focused on financial risk taxonomy. The subsequent discussion resulted in a financial risk taxonomy which was further used in the research. It was concluded that the classification of financial risks was: interest rate risk, foreign exchange risk, commodity risk, credit risk and liquidity risk. In line with the financial risk definition, risk of a loss caused by unfavourable change on financial markets was represented by the risk of changes in market interest rates, foreign exchange rates and commodity prices. Poor management of financial assets and liabilities was represented by liquidity risk and credit risk.

The outcome of the empirical review was presented in two stages. In the first one were compared the above pre-defined categories with risks reported by the companies. The comparison provided an empirical agreement as the percentages rose above 90% with an exception of commodity risk. The first point of conclusion was not to remove any risk type from the pre-defined financial risk classification. In the second stage were identified other risks from the empirical review (price risk, market risk, operational risk, compliance risk and stock

risk). Upon a discussion, the second point of conclusion was to add the stock risk into the pre-defined financial risk classification.

Adding the empirical review results into the preliminary concluded financial risk classification, the accepted financial risk taxonomy was determined as follows: interest rate risk, foreign exchange risk, commodity risk, stock risk, credit risk and liquidity risk, while the first four risk classes shall be considered as sub-categories of market risk and the last two classes as results of poor financial management.

The results of this paper are intended to open expert discussion on financial risk definition and taxonomy, as well as to build a framework for further research on risk, solvency and liquidity management.

## **6.1 Future Research Directions**

Due to the limited topic of this paper, some of the related areas have not been discussed to the full extent. Discussed were only selected types of financial risk although some of the risks with an impact to the financial situation and position of the company were not mentioned or stressed enough. Some of the next research initiatives are suggested below.

The next research step is to continue with the research on financial risk and to discuss the individual types of business and financial risks to depth. There are additional, very practical, risks arising from decision support, such as model risk (Allen, 2012) or spreadsheet risk (PwC, 2011), that shall be further elaborated.

The financial risk management direction allows focusing on different business types and role of the business segment in financial risk management; alternatively comparing the financial risks reported by individual companies to business groups. Another topic relevant to financial risk management is an empirical study assessing how companies mitigate the financial risk they are facing to.

A research idea tending to financial accounting direction is to evaluate the compliance of reported disclosures with IFRS 7 and their quality. Finally, authors can also continue in the theoretical research and discussion of meaning of risk and uncertainty and their connection.

## **References**

- Allen, S. L. (2012). *Financial risk management: A practitioner's guide to managing market and credit risk*. Hoboken: Wiley.
- Christoffersen, P. (2003). *Elements of financial risk management*. Boston: Academic Press.
- Cooper, R. (2004). *Corporate treasury and cash management*. New York: Palgrave Macmillan.
- Hampton, J. J. (2011). *AMA Handbook of financial risk management*. New York: American Management Association.
- Horcher, K. A. (2005). *Essentials of financial risk management*. Hoboken: Wiley.
- Hubbard, D. W. (2014). *How to measure anything: Finding the value of intangibles in business*. Hoboken: Wiley.
- IAS 32 (2003). *Financial Instruments: Presentation*. International Accounting Standards Board.
- IFRS 7 (2005). *Financial Instruments: Disclosures*. International Accounting Standards Board.

- Malz, A. M. (2011). *Financial risk management: Models, history, and institutions*. Hoboken: Wiley.
- Marek, P. (2010). *Riziko – přístupy k jeho vymezení*. Paper presented at 5. Mezinárodní konference Řízení a modelování finančních rizik, Ostrava. Ostrava: VŠB-TU Ostrava.
- PwC. (2011). *Managing spreadsheet risks*. Retrieved from <https://www.pwc.com/gx/en/insurance/solvency-ii/pdf/pwc-countdown-june-11-managing-spreadsheet-risks.pdf>
- Schönborn, J. (2010). *Financial risk management: Management of interest risk from a corporate treasury perspective in a service enterprise*. Hamburg: Diplomica Verlag.
- Skoglund, J., & Chen, W. (2015). *Financial risk management applications in market, credit, asset and liability management, and firmwide risk: Applications in market, credit, asset and liability management and firmwide risk*. Hoboken, N.J.: Wiley.
- Sweeting, P. (2011). *Financial enterprise risk management*. New York: Cambridge University Press.
- Van Deventer, D. R., Imai, K., & Mesler, M. (2013). *Advanced financial risk management: Tools and techniques for integrated credit risk and interest rate risk management*. Hoboken: Wiley.

## Contact information

### Ing. Lucie Brabcová

University of Economics in Prague, Faculty of Finance and Accounting  
W. Churchill Sq. 1938/4, 13067, Prague 3, Czech Republic  
E-mail: [lucie.brabcova@vse.cz](mailto:lucie.brabcova@vse.cz)  
ORCID: 0000-0003-0301-921X

doi: 10.7441/dokbat.2019.011

# ECO LABELS, CRADLE TO CRADLE CERTIFICATE AND THEIR CONNECTION TO THE SUPPLY CHAIN

*Kristijan Brglez, Žiga Korent, Matevž Obrecht*

## Abstract

The concept of eco-labels and their recent development in the past few decades is a good example of improvement in departments of manufacturing, logistics, sustainable supply chains, etc. Especially the latter one has the most significance to the impact of logistics the in environment. However, what are eco-labels and what are they meant for? Because there are still companies even today, that do not understand the advantages of having an eco-label and the positive impact it can have on the environment, we decided to explain the meaning of them through a short description. Furthermore, we will try to present one of those eco-labels, namely “cradle to cradle” certificate, and how was it implemented into some companies in real life. Such labels are also a starting point in establishing a successful supply chain. In the end, the true purpose of this paper is to spread recognition of eco-labels and their purpose, while at the same time explain the concept of one such eco-labels and their connections to the supply chain, in hope of encouraging companies to start thinking “out of the box”.

*Keywords: ISO 14000, cradle certificate, eco-labels, environment, supply chain*

## 1 INTRODUCTION

With every year, there is more and more development in the department of logistics. This compliments the department and shows that logistics is gaining more and more value with every year in all other departments, either as a main player or a support player. One of such developments, which we will particularly focus in this paper, are the introduction and implementation of eco-labels or so called “Green Stickers”, which are mostly, if not all, based on the series of ISO standards 14000. This series of standards are focused mostly on the management of activities of companies, rather than environment as whole. In practice this means, that they are not obligatory, as other are, but instead help a company to develop its own environmental policy and in process also implement it into its own processes, which a company has (Praznik & Novak, 2000). All this helps the company in a long-term development, as it can lower its impact on the surrounding environment, become more competitive on the market, boost its own brand and image, as well as fulfil the environmental obligations, given either by European Union (EU), or the country of its origin (Praznik & Novak, 2000). This series of standards lead to another interesting series of standards, namely ISO standards 14020 to 14025. This ones in particularly are much more interesting for us, since they focus on our eco-labels, which we mentioned and which we will further explain down the road. If we focus back on the eco-labels, we have quite a lot of them all around the world, all developed by different companies, organizations, as well as countries. This can lead to quite a confusion around them, but in short most of them are quite recognized, and as mentioned by ISO standard 14000, can help boost a company’s reputation in the world market by a lot. As such, they are getting progressively vital for a successful or failed “market penetration”. Because of that, more and more companies are in progress of obtaining them, or in the process of implementation into their processes. One of these eco-labels or in our case more like “eco-certificate”, is also the “Cradle to cradle” certificate or in short “C2C”. Unlike the other, more commonly known eco-labels, the picked certificate is much less known, but as such it is not less developed or complicated as the others. Because of its lesser recognition in the World, we decided to research

the before mentioned certificate, or better yet what the certificate is all about, as well as try to find some successful implementation of this mentioned certificate into company's processes. The end goal of our paper is mostly focused on gaining better recognition of this certificate, as well as the recognition and importance of eco-labels as whole.

This paper is structured as follows: In Section 2, a literature overview about eco labels and ISO standards is given, especially focused on the standards in connection to our own certificate. Methodology used in the process is mentioned in Section 3. In Section 4.1, an overview of the mentioned certificate is given, motivating an example/s of good practice in real life given in Section 4.2, as well as motivating potential improvements and implementations given in Section 4.3. In Section 5 a commentary of current progress of picked certificate is given. This paper closes with a conclusion and potential future development of paper in Section 6.

## **2 LITERATURE REVIEW**

Since we are not the first ones focusing on eco-labels and ISO standards connected with them, we decided to first make a quick review of already published articles and manuscripts on this thematic. Firstly, we will focus on explanation of ISO standards 14020 to 14025, which are more detailed described in the brochure from ISO organization itself. The ISO 14020 series of standards is a globally recognized and credible set of benchmarks, which are mostly focused on preparing businesses with their environmental labelling, which is getting increasingly used on products, as an answer on the increasing demands of their customers. (ISO, 2012)

With the current focus being mostly directed at environmental changes of climate and health, the demands of customers for greener and environmentally friendlier products is rapidly increasing. This on the other hand forces the manufacturers, to start thinking out of the box and start to show the customers, that their products fit their demands. One of such way is also with eco labels.

Eco labels as such were created as a necessity to appeal the customer demands, but on the other hand are also a good indication of current policy of a company or manufacturer, who wants to show what he is trying to improve, to make his companies processes environmentally friendlier. ISO itself noticed the lack of standardized sustainable development agenda and as such worked hard to implement a unified standard for this emerging agenda. The ISO 14020 series are the answer of the ISO on these occurring problems. These series of standards deal specifically with aspects of environmental labels and declarations. (ISO, 2012)

At the start, there were only two majorly visible types of standards, but with time, there was also a third type recognized and which is now more or less incorporated into the existing standards. These types of standards are (ISO, 2012): (I) environmental labelling, which are the "classic" eco-labelling schemes, (II) self-declared environmental claims, which are made by manufacturers and businesses, (III) environmental declarations, which mostly focus on describing the environmental aspects of product.

Since C2C is Type III environmental declarations, we will focus on the standard which covers this declaration, namely the ISO 14025 standard. The ISO 14025 standard establishes principles and specifies procedures, which are used for issuing quantified environmental information about products, mostly focused on life-cycle data, and which are referred to as environmental declarations. The standard is special, since it is not entirely based on the parameters of the ISO 14040 series of standards, but includes additional environmental information, which others lacks. Type III environmental declarations as such present the environmental performance of a product and enable a comparison between products fulfilling the same function. (ISO, 2012)

Such declarations are (ISO, 2012): (a) based on independently verified life-cycle assessment (LCA) data, life-cycle inventory analysis (LCI) data, converted LCI data to reflect the life-cycle impact assessment (LCIA) of a product or information modules in accordance with the ISO 14040 series of standards and, where relevant, additional environmental information; (b) developed using predetermined parameters; and (c) subject to the administration of a programme operator, such as a company or a group of companies, industrial sector or trade association, public authorities or agencies, or an independent scientific body or other organization.

In such Type III environmental declarations have the advantage of public comparison of products and as such grant a consistency within industry, available to the whole public. As such these environmental declarations, according to ISO 14025, are probably the only internationally recognized tool, which enables such comparisons to be carried out. This in the end is exactly what is needed, from a view of potential customers, in making fair selection among different bids. (ISO, 2012)

In the end Type III environmental declarations are one of the most complicated declarations, mainly because of the range of environmental impacts (mostly perspective of the life cycle of a product) covered in them. This makes the declarations in some cases way to specific and detailed, and in the end deny the adaption to specific user need and market applications. As such there are many approaches developed, one is the concept of so-called single-issue Type III environmental declarations. These declarations, can extract the information in a Type III environmental declarations, related to a specific environmental aspect; for example house gas emissions, which makes the declaration a climate declaration. There are many other concepts like the one before, but these are mostly used on the type of products we want to evaluate. (ISO, 2012)

### **3 METHODOLOGY**

In our research we mostly focused on obtaining the needed information for our paper. As such, we conducted a qualitative research, meaning that we were collecting, analysing and interpreting data, which was already beforehand researched and written. As such, we firstly gathered information on the necessary ISO standards, which we already mentioned, with the help of internet. The information on these standards was mostly gained through the information brochures of ISO itself. Following the standards, we focused on our own certificate, for which the information was used from the official site of institute, which grants the certificates, as well as searched for information, about the development of the concept, which the certificate uses as its main purpose. Following the analysis of the gathered information, we compiled the gain knowledge about the matter in this paper, I a manner that can be read for everyone to understand.

### **4 CERTIFICATE CRADLE TO CRADLE**

The certificate cradle to cradle is a good example of a Type III environmental declarations, since it is primarily focused on the Life-cycle of products, in this case from the beginning of the product all to its end. What makes this certificate more specific or different from others, is the fact that it wants to implement an enclosed life-cycle, meaning that that the product is not entirely discarded at the end of its lifetime, but is instead again incorporated into another product. To understand more about the certificate, we will now try to focus on its development, idea, as well as represent this idea in real life in the next sections.

## 4.1 Development and idea

To understand the whole meaning and purpose of the certificate, we have to explain firstly the concept or the idea on which the certificate is based on. Cradle to cradle concept was first mentioned in a research report to the European Commission in Brussels in the year 1976, by Walter Stahel and Genevieve Reday-Mulvey. Their research “The potential for substituting manpower for energy“ presented a vision of an economy in loops or later called circular economy. It was primarily focused how such economy could have an impact on job creation, economic competitiveness, etc. The research was later published in a book “Jobs for Tomorrow: The potential for substituting manpower for energy“, and the factors mentioned in the book, are today referred to as the three pillars of sustainable development: ecologic, economic and social capability. Stahel then continued with the ideas and wrote a paper “The Product-Life Factor“, where he discovered or better yet identified that selling utilization instead of goods is much more profitable and can lead to a better business model of a loop economy; in short selling utilization creates sustainable profits and removes the costs and risks that were connected with waste. (Product-Life Institute, n.d.)

The next step was the denial of the newly developed concept, namely “cradle to grave“. Although the concept was widely recognized and already started to be implemented, one of the main reasons being rather compatible with the existing linear economic model, Stahel refused the idea, because it was still only an upgrade for gravediggers, who wanted to get rich with waste, and the whole concept was more or less just an advanced upgrade which relied on end-of-pipe solutions. Rather than the concept presented by other experts, he promoted another concept, namely “cradle back to cradle“, which would use durable goods in a loop and as such be much more sustainable. At the same time another expert by the name Michael Braungart, promoted the same concept, mostly as a response to the rise of the “cradle to grave“ concept, which was according to him, still relying too much on the end of the pipe solutions. The two men soon met and started to co-work on the newly established concept. (Product-Life Institute, n.d.)

Following the collaboration, Braungart linked with another expert, namely William McDonough and the two men published a manifesto in year 2002, called “Cradle to Cradle : Remaking the Way We Make Things“, in which the whole design was described in detail. Following this published manifesto, a number of companies decided to implement it, although soon criticism fall on both authors, mostly for the lack of granting the certificate to other companies, other than those in the inner circle (Sacks, 2009). Following this pressure, the two decided to establish a special institute, called “Cradle to Cradle Products Innovation Institute“, with which they enabled for the certificate to be publicly obtainable for every company, that is prepared to implement the certificate and its demands.

If we now focus more on the certificate itself and the process behind it. Rather than being forced to pay for obtaining the certificate, as it is with other recognizable eco-labels, the C2C is free to get and works mostly on a donation system, meaning that the companies donate how much they want. This in a way is also much more appealing to the companies, who want to improve their processes. The whole process of gaining the certificate begins with the company reviewing its products and its capability with the demands of gaining the certificate. If the product is appropriate for the certification, the company needs to select an Accredited Assessment Body, which then conducts a careful analysis. The data, which is then collected with the help of assessor, is send to the institute, which decides if everything is according to the rules. If it turns out everything is all right, the company receives the certificate, after which it works with the institute in promoting the product, as well as improving its processes. After that, on every two



years a new re-certification is fired, with the intention to review the reported progress (Cradle to Cradle Products Innovation Institute, 2018).

The main idea of the certificate itself, lies in a continual improvement process that looks at a product in five quality categories (Cradle to Cradle Products Innovation Institute, 2018): (a) Material Health (chemical ingredients of every material in a product), (b) Material Reutilization (designing products with materials that can safely be returned to nature or industry), (c) Renewable Energy & Carbon Management (manufacturing powered mostly by renewable energy), (d) Water Stewardship (manage clean water), (e) Social Fairness (design operations to honour all people and natural systems which are affected by the product through its life cycle).

The product, which the company certified, gets achievement in each of the previously mentioned categories. These achievements are Basic, Bronze, Silver, Gold and Platinum. Unlike others, the product gets its overall scoring based on the lowest achievement level he achieved (ex. if the Product has 4 Gold marks and 1 Silver mark, the overall certification level of the product is Silver). Of course this can be always improved and perfected with continuous improvement of the processes connected with the product, as well as guideline for the company, what is needed to be done or which category needs further improvement for the product to become better.

If we conclude all what was described in a simple example of a product such as a shoe; Shoes are being made in a factory, where the sole is made from »biodegradable materials«, while the upper parts are made out of »industrially made materials«, with which they complement the material health category. The factory uses for example off-cuts of rubber soles for the development of new soles, with which it drastically lowers its waste and complements material reutilization category. After the finished production, the shoes are sent to retailers, where the buyer pays for the shoe significantly less than for a comparable shoe. That is because the buyer pays only for the usage of the materials, for the period of time he will be using the shoe, with which they complement the social fairness category. After the shoe is for certain reason unusable, it is returned to the factory, where the soles and upper parts are divided. The soles are then returned into nature, where they biodegrade, while upper parts are again used in factory for creation of new shoes. Although this is a simplified example, it clearly shows the difference between other concepts, where the whole cycle of a product is in many ways incomplete. To improve furthermore the understanding of this concept, we prepared in the next section, few examples of this concept in real life.

## **4.2 Examples of good practices**

If we look at some good examples of good practices. That means companies that have achieved the eco-label of cradle to cradle. To begin to understand the value and importance of such a label for a company. As such, we are going to look at two examples of companies that have achieved the eco label of cradle to cradle. To get really a perspective of how it the label is not depended on resources, we will be looking at two companies. The first one is Philadelphia Commercial and the second one is Ecosnythetix.

Let's look at the first company Philadelphia Commercial is a company located in as the name suggest Philadelphia and is specializes in the production of carpets and other floor surfaces. The company itself is part of Shaw Industries, one of the biggest companies on the south coast of the USA. How they produce their products is as important as the way they design them. That's why they employ sustainable manufacturing practices by making efficient use of materials and natural resources, using alternative and renewable energy sources when possible (including a roof mounted solar array), and designing and operating facilities and manufacturing processes in accordance with widely recognized sustainability and safety

standards. Providing environmentally responsible solutions for reclaiming and recycling carpet is a big part of their commitment to sustainability. They have a commercial take-back program and reclamation partners serving major US cities - making it easy to make sure the carpet you no longer need stays out of the landfill. Once their carpet products have reached the end of their useful life, the options include being converted back into carpet, into raw materials for other industries, or into energy to power of their manufacturing operations. They have come to realize that every choice made inside the organization has a ripple effect that influences far beyond operations. Which in turns means, they must take great care to make decisions at each step along the way that focus on creating a better future for environment. Philadelphia Commercial is as stated before a part of Shaw Industries a leading company in environmental and corporate social responsibility. Shaw industries is a leader in carpet reclamation and has recycled more than 800 million pounds of carpet and counting since 2006. (Philadelphia Commercial)

The second company is a smaller one and not a part of a huge conglomerate like Shaw Industries, it is a smaller company located in Canada called EcoSynthetix. It is a renewable chemicals company specializing in bio-based materials that are used as inputs in a wide range of products. Their products are cost-competitive and exhibit similar performance characteristics compared to the non-renewable products they replace. Such sustainable products allow customers to reduce their use of harmful materials, such as formaldehyde and styrene-based chemicals. Supplying better, greener materials from extraction to delivery and are their commitment to helping reduce their environmental impact. With low waste and almost zero by-products, biopolymer manufacturing processes are up to 99% efficient and adhere to all 12 Principles of Green Chemistry. From improving product recyclability to lowering manufacturing and supply chain emissions, choosing our biopolymers will not only a company reach its sustainability objectives, but also their products can help other achieve their goals as well of improving product recyclability to lowering manufacturing and supply chain emissions. Their two most important products are EcoSphere, Biolatex and DuraBind. EcoSphere is in the commercial use around the world in the paper and paperboard packaging industries. It is used as a replacement for petroleum-based Styrene Butadiene (SB) used in magazines, books and packaging like cereal boxes). DuraBind™ biopolymers are a no added formaldehyde binder system used in the production of wood composite panels. Their main selling point are environmentally sustainable products can be used in the manufacturing process for a range of applications in the paper, paperboard, building products, adhesives and personal care markets. EcoSynthetix products allow customers to reduce significantly their carbon footprint, while offering equal or superior performance, often at a reduced cost relative to incumbent petroleum-based products. (EcoShynthetix Incorporate, 2017)

### **4.3 Potential future improvements**

Today's industry and economy needs a positive agenda to define its future. We need real innovation, intelligent product design and quality, and that means we have to stop using sustainability concepts, which are only trying to correct unfixable errors in our old system. Sustainability is not innovative by definition. Innovations are disruptive and change the status quo, whereas sustainability preserves it. Efficiency rhetoric is not getting us anywhere, and for us to aspire only to become less bad at what we do is simply not good enough. We have no other choice than to leave that linear economy behind. We are capable of thinking in a circular way and creating high-quality alternatives that are beneficial for people and nature. This would be a 'Cradle to Cradle' economy in which material flows, products, buildings and cities support a symbiotic relationship between ecological systems and economic growth. All materials would maintain their status as resources and could then be used repeatedly. New business models will enhance the transition in which we will pay for the use of a particular service, and not the

ownership. The Cradle to Cradle design frees us from our current responsibility to reduce any negative environmental effects from our behaviour. (Braungart, 2015)

## **5 COMMENTS AND DISCUSSION**

To simplify all the text above instead of focusing on reducing resource consumption we should focus on a regenerative approach to sustainable development based on these central principles. Value materials as nutrients for safe, continuous cycling from these facts we can deduce these main principles: (a) All operations are to be ran with 100% renewable energy, (b) Water is precious resource, (c) Promote diversity in all systems.

The C2C paradigm is a new approach to business development. This approach is also known as Circular Economy. Circular Economy is different from conventional business models by focusing on the supply chain economy and the possible business opportunities that arise when broadening the horizon from gate-to-gate to cradle-to-cradle. The reason for this new horizon is the fact that current and future businesses need to ensure a closed or semi-closed loop in their material cycles due to ever less resource availability. Another benefit of the C2C product certification is the identification of substitute materials in the material supply chain in order to dangerous parts from the raw materials used in production. Because of their change of horizons, businesses are now changing their business models towards with the entire material loop in their product. This also influences how we design new products or new buildings because products and building elements become part of a different business model with a different scope than the conventional business models - especially when it comes to buildings. In other words, the Cradle to Cradle paradigm teaches us to think in a whole new way. When it comes to building design, it teaches us to design recyclable and adaptive solutions corresponding with the technical or expected lifespan of building components. It also challenges us because our waste management systems and waste-to-energy systems are based on a completely different approach to sustainability. (Ring Hansen, 2015)

Another aspect of this involves making products to work with nature. A good example are companies like Philadelphia Commercial. Their main mantra is to work well with nature future designs can also follow the example of nature. Natural systems do not have waste products. Instead, materials become food for other organisms. In this sense, ecosystems are the original cradle to cradle system, where no materials are thrown away and taken out of circulation. Nutrients are materials that can safely decompose to feed biological cycles. Technical nutrients are materials such as the book paper, which can safely be recycled and used again to make more products. It is important that a product can be easily disassembled, so its parts can contain biological nutrients and parts that will become technical nutrients. For example, a small part of a company can be easily separated into its components at the end of its cycle can be separated into components to be composted and rubber components that can be recycled to make new and useful components. Currently, however, many procedures are what some authors call “monstrous hybrids” that can neither decompose to feed biological cycles nor be properly reused in industrial cycles and so become toxic refuse dumped in landfills or are just taking space and resources in companies. Another important way of following nature is making decisions that are appropriate to local environments rather than just the most simple and profitable solution. Designing plans to be in line with the local environments makes them more efficient and more effective, especially if the production process employs local energy sources and materials. (McDonough & Braungart, 2010)

## 6 CONCLUSION

From the contest in this paper we can plainly see that regardless of the product you are manufacturing, keeping your operating costs down is the name of the game. The idea of making product or services more environmentally friendly typically means higher costs for manufacturers and ultimately a higher price for the consumer. However, this is no longer the case. The journey to a fully sustainable product and services does not have to happen overnight. The process of making the transition over time to a product that not only uses renewable ingredients, but also improves your overall manufacturing performance, delivering a superior product.

If we look at the two companies presented, we conclude that because of their use of C2C they will have opportunities for success. Philadelphia Commercial has a solid foundation and many opportunities for growth. In addition, with the frequency with which companies will encounter unexpected changes in their business will increase leading to a paradigm shift in the way they consume real estate. Interestingly, the increase in sublet space only reflects a fraction of the underlying efficiency problems faced by businesses. Sublets are only viable if the tenant can break off and market a discrete piece of their premises. However, there are many companies realize potential space efficiencies without significantly renovating their entire premises. As for EcoSynthetix is working to deliver bio-based products to customers in a number of industries. Our commercial bio-based products are designed to deliver improved performance characteristics compared to petroleum-based products and other bio-based materials – often at a reduced cost. In a society depended on fuel consumption that will be a big advantage.

Although it is difficult to step out of common and regulated zones and to question the fundamental errors causing the latest crises, we need to counter tradition of only finding profit with new sustainable approaches. Economies, cultures, social relations and political systems are so intensively intertwined that no countries and citizens can exist without each other. Every day, now and in the future, there more and more ever changing conditions. People are capable of doing this without losing their sense of having an identity or taking on a burden. We celebrate our individuality and freedom but it remains a challenge to think differently. With the ongoing unification of educational systems, individuals have freedom but are taught to think within standardised concepts. We need to respect people, and look at what they, as individuals can do instead what they cannot. New social models such as C2C can make it possible for people to extend their contribution to society and increase their dignity at the same time.

### References

- Braungart, M. (2015). *A 'Cradle to Cradle' economy is Europe's only future*. Retrieved from <https://www.friendsofeurope.org/insights/a-cradle-to-cradle-economy-is-europes-only-future/>
- Cradle to Cradle Products Innovation Institute. (2018). *Get Certified*. Retrieved from <https://www.c2ccertified.org/get-certified>
- EcoShynthetix Incorporate. (2017). *EcoShynthetix Incorporate*. Retrieved from <http://ecosynthetix.com/>
- ISO. (2012). *Environmental labels and declarations: How ISO standards help*. Retrieved from <https://www.sfs.fi/files/2480/environmental-labelling.pdf>
- McDonough, M., & Braungart, M. (2010). *Cradle to Cradle: Remaking the Way We Make Things*. New York: North Point Press.

- Philadelphia Commercial. (2015). *Philadelphia Commercial*. Retrieved from <http://www.phillyqueencommercial.com/>
- Praznik, M., & Novak, P. (2000). ISO 14000 - Namen okoljskega standarda in njegove posledice. *Strojniški Vestnik*, 1(46), 35-43. Retrieved from <https://www.dlib.si/details/URN:NBN:SI:doc-I0BN1T3W>.
- Product-Life Institute. (n.d.). *Cradle to cradle*. Retrieved from <http://www.product-life.org/en/cradle-to-cradle>
- Ring Hansen, H. (2015). *What Cradle to Cradle Teaches Us About Sustainable Development*. Retrieved from <https://www.linkedin.com/pulse/what-cradle-teaches-us-sustainable-development-hanne-tine-ring-hansen>
- Sacks, D. (2009). *Green Guru William McDonough Must Change, Demand His Biggest Fans*. Retrieved from <https://www.fastcompany.com/1186727/green-guru-william-mcdonough-must-change-demand-his-biggest-fans>

## Contact information

### **Kristijan Brglez**

University of Maribor, Faculty of Logistics  
Mariborska cesta 7, 3000 Celje, Slovenia  
E-mail: [kristijan.brglez@student.um.si](mailto:kristijan.brglez@student.um.si)  
ORCID: 0000-0002-3882-0958

### **Žiga Korent**

University of Maribor, Faculty of Logistics  
Mariborska cesta 7, 3000 Celje, Slovenia  
E-mail: [ziga.korent@student.um.si](mailto:ziga.korent@student.um.si)  
ORCID: 0000-0003-3985-4524

### **Matevž Obrecht**

University of Maribor, Faculty of Logistics  
Mariborska cesta 7, 3000 Celje, Slovenia  
E-mail: [matevz.obrecht@um.si](mailto:matevz.obrecht@um.si)  
ORCID: 0000-0001-8301-7382

doi: 10.7441/dokbat.2019.012

# PACKAGE-FREE FOOD SALES AS A NEW TREND IN SLOVAK REPUBLIC COMPANIES

*Rebecca Brodňanová, Marek Plachý*

## **Abstract**

The aim of the paper is to evaluate new trends in food sales in the Slovak Republic. Specifically, we have focused on package-free sales of the food. Package-free sales of the food are one of the new trends in our market that are gradually being applied in our market. Its main essence is the ecological shopping of food and supplementary assortment into the household. Consumer attitude towards package-free shopping of food was the main finding of the research. In the first chapter we dealt with theoretical knowledge about agriculture, agrarian marketing, distribution, sales and packaging as such. In our own work, we evaluated the situation using a questionnaire survey and SWOT analysis of the selected company. Respondents responded to their purchasing experience in a package-free store. With the help of SWOT analysis, we were able to match his strengths and weaknesses in Žilina, as well as his opportunities and threats.

*Keywords: agrarian marketing, food sales, new trends, package-free sales*

## **1 INTRODUCTION**

The aim of agrarian marketing is to support the sale of domestic agricultural and food products on the domestic and foreign markets through modern activities. When developing marketing concepts, it is necessary to take into account important characteristics of the agrarian market in relation to land management.

Nowadays, the consumer is different from a few years ago. Today's consumer is much more connected to technology, watching brands and what is happening on the market. He is much more aware of the environment and the social responsibility of brands. It recognizes the importance of maintaining a good environment. That is why it is searching for shops, respectively brands that are related to this philosophy.

One of the latest trends to attract a customer is through the environmental aspect of the business. Nowadays businesses are overtaking which is more or less ecological. A customer who is fascinated by this trend first learns about the company, their philosophy, and what they do for the environment. New sales trends are new ways to reach potential customers in a different way.

One of the alternatives is the package-free sale, which we discussed in the article. Package-free stores offer the consumer the ecological purchase of food and other products offered by a particular store. Package-free sales are a sales concept where the consumer brings his own containers for the whole range of products the shop has. The food or other assortment is weighed into the container, and the customer pays for what he has taken into the container. It must be argued that, for such a type of consumer, packaging has no role. All important information can be found on the label that is next to the containers.

## **2 THEORETICAL BACKGROUND**

Rovný et al. (2007) notes that the agri-food sector will decline. This is the cause of inefficient but also poor quality production of domestic producers. The different economic focus causes

them a disadvantage compared to their competitors. He also says that the market and trade are more capital-intensive than the nature of primary production and processors of the food industry. Kárpáti and Lehota (2007) talking about marketing in a narrow sense includes consumer orientation. In the last decade, the competitive orientation has become a very important part in continuous monitoring of the marketing environment. Baco (2010) says that even when developing marketing concepts, it is important to take into account the important peculiarities of the agrarian market in relation to land management. The most noticeable peculiarities of breeding and cultivation processes include the biological nature of business, seasonality, coherence and urgency of production, the impact of natural factors on production processes, the shelf life of products and others.

As Dalíková (2013) new marketing opportunities will depend on the ability to innovate their solutions and exploit in a socially responsible way, which is a way of maintaining business prosperity. Marketing requires managers to have greater mobility, imagination and knowledge of target group habits. They must therefore take into account: (a) Tendencies to harmonize European consumers' consumption and take into account environmental impacts; (b) Ethics in marketing; (c) Euromarketing; (d) International aspects in marketing; (e) New trends in marketing; (f) The relation of the Internet to the development of marketing; (g) Application of more holistic marketing - mutual beneficial relationships of all interest groups; and (h) The need to integrate sustainable marketing development.

## **2.1 Sales**

Before selling it is important to define the target market as well as its specifics. The segmentation criteria are the market selection tool. These should ensure identification of customer needs, facilitate customer relations, market compliance with business competencies. The requirements of the company and the context in which it operates depend on the nature of the company. Therefore, if the company wants to attract long-term customers should use value segmentation. The definition of the target market can be based on the following aspects: (a) Customer life cycle; (b) Profitability of customer contacts; (c) Customer potential; (d) The importance of customers in the customer portfolio; (e) Customer loyalty; and (f) Penetrating (Kita, 2017).

According to Vicen (2010) is the essence of sales to satisfy consumers' needs and expectations. It is a challenging activity that involves complex coordination efforts. In their business, they consider sales to be the most important strategic element. If a business wants to commercialize goods, it must know what the attitude of consumers is to the price level, the goods themselves, channels and forms of distribution. Vaňák (2011) says that for market organizations to succeed in the strong competitive environment and constant market changes, it is essential to focus on product price levels, the degree of variability in the product range, and how products are offered at a given time.

## **2.2 Container**

Nagyová et al. (2018) said that packaging is mainly used to protect the product from climatic, mechanical and biological effects. They also help to move goods reasonably. In the end, he carries important information about the product that is packaged therein. Among their negative aspects are mainly that they pollute the environment. They are often made of plastics, paper or other materials. Packaging functions are divided into 6 groups as protective, handling, information, promotional, ecological, economic functions. According to an article on the website [interez.sk](http://interez.sk), the Ministry of the Environment: "Envirorezort wants to promote the generation of packaging waste by developing a methodological tool for the introduction of packaging and the use of reusable packaging."

### 2.3 Trends in sales

Goel (2017) there are several trends: (a) 1 + 1 - This is a trend where the customer gets one when buying one piece for free; (b) Customer Relationship Management - focuses on customers rather than the technology it manages. Examples of incentives are bonus points; (c) New media - it is a result of science and technology. This is why new media such as e-commerce, online shopping, mobile applications, vending machines are entering the market; and (d) Customer expectations - the customer is educated nowadays and therefore expects certain activities on the part of the seller and can avoid them.

New trend according Beňová (2019) is once used to buy food in glass or cloth packaging, but the current supermarkets are not adapted to it. However, packaging-free shops arise, where it goes without saying.

According to Nagyová (2017), the concept in Slovakia is expanding, with a new goal to save the environment. The owners of such packing-free stores try to produce zero waste. They adhere to the worldwide known concept of zero waste.

## 3 AIM AND METHODOLOGY

The main aim of the article is to evaluate new trends in food sales in the Slovak Republic. Specifically, we focused on package-free food sales. In our conditions, packaging-free food sales is one of the new trends that are gradually finding use in our market. In order to be able to achieve the main goal, we have set partial goals, namely: (1) Summarize theoretical knowledge that focuses on new trends in food distribution and sale in Slovakia; (2) Characterize the new trend chosen by us: “packaging-free”; (3) Conduct a questionnaire survey to identify primary data and then evaluate the purchase in this type of retail; and (4) Make suggestions to improve purchasing in this type of store, which we have demonstrated from the information gathered and the analysis of the survey results.

In the first chapter of the article we focused on the definition of basic terms for marketing, agrarian marketing, food sales or new trends in food sales and last but not least also packaging as such. The information obtained from secondary sources helped us to work out the theoretical part. Using the literature of Slovak and foreign authors dealing with the mentioned areas. In addition to book publications, we used information from Internet publications, proceedings, scientific journals or laws. We were assisted in the compilation of information by various working methods, namely analysis, synthesis, data collection, induction and deduction and directed interview.

The information and data mentioned in this paper have been obtained from questionnaire. The questionnaire was conducted in March in 2019. We tried to have the widest possible spectrum of respondents or gender, but also regional. The questionnaire has been published on several Facebook and Instagram pages. With the publication of our questionnaire survey we were helped by the packaging-free weighing Váž si and Zero Waste Slovakia. A few respondents were approached randomly in a packaging-free shop directly in Žilina.

The questionnaire consisted of 21 questions, and at the beginning of the questionnaire we informed the interviewees about the aim of our survey. The first 15 questions in the questionnaire were merit. The other 6 questions were focused on the identification of basic identification data. Based on our questionnaire survey, we obtained information from 208 respondents from all regions of Slovakia. Out of 208 respondents, 102 said they were already shopping in a packaging shop. These respondents responded quickly to questions about the shopping experience. 170 women and 38 men participated in our survey.



### 3.1 Methods

**Questionnaire survey** - the frequency of use of this method has increased in particular through the expansion of information technology. The success of this method is conditioned by correctly worded questions, willingness of respondents as well as truthful answers. This method is used mainly for the detection of data of a qualitative nature, but occasionally also when collecting factual data of quantitative nature. Responses processed in Excel. We also expressed the data graphically in the form of graphs and tables with absolute or relative values. We used to close, open, multi-select and scaling questions. Where the respondent had to accurately determine their attitudes and perceptions.

**Guided interview** - is one of the techniques of data collection in social research. The interviewer proceeds question by question by the respondent. He answers the questions. The advantage is that the respondent must answer every question asked. We used this method at the owner of the Váž si store in Žilina. This gives us a better understanding of the whole concept and also the initial impressions of the shop owner from the customers. In addition to the questionnaire survey, we also used a controlled interview with the owner of the packaging company in Žilina, namely Veronika Kormancová. In this interview, we obtained primary information from the owner. We used these primary sources to process the swot analysis.

**SWOT analysis** - the aim of the SWOT analysis is to evaluate the internal prerequisites of the company to achieve a certain business goal and to subject the analysis to external opportunities and limitations determined by the market. It is the primary tool used to assess the status quo from different perspectives, from the approach of strengths, weaknesses, opportunities and threats. At the same time, it outlines possible alternatives of future development, possibilities for their use or their solution.

In addition to the methods mentioned above, we also used contention tables in this work and the Chi square test method ( $\chi^2$  test). For the purposes of testing statistical hypotheses, we chose the  $\chi^2$  square contingency test. This test should be used when quantitative quantities are compared. It is used in determining whether the frequencies in each category are randomly, naturally or whether the distribution of the frequencies in each category has been triggered by a particular incentive. On the basis of this test, the frequency of occurrence, as well as the dependence between variables, are tested and determined. For all six hypothesis tests, the same procedure was followed: (1) We have determined a dependent and independent variable; (2) We formulated hypotheses H0 (There is no statistically significant link) and H1 (There is a statistically significant association); (3) We compiled pivot tables for observed ( $E_i$ ) and expected ( $T_i$ ) frequencies; (4) We calculated the Chi-square value; (6) We calculated a table critical value; and (6) We set the conclusion of the findings.

We calculated the expected frequencies ( $T_i$ ) using the following formula:

$$\left( T_i = \frac{\sum \text{relevant column} * \sum \text{relevant line}}{\sum \text{total amount}} \right) \quad (1)$$

We calculated the Chi-square value according to the following formula:

$$\left( \chi^2 = \sum_{i=1}^m \sum_{j=1}^k \frac{(E_{ij} - T_{ij})^2}{T_{ij}} \right) \quad (2)$$

where:  $E$  - empirical abundance;  $T$  - theoretical abundance;  $m$  - number of rows;  $k$  - number of columns;  $n$  - total number of measurements; and  $\chi^2$  - calculated test criterion - test characteristic (TCH).

Using the CHINV function (the function is used to compare the recorded results to determine if the original hypothesis is valid.), we calculated a table critical value in Excel:

$$\chi^2_{tab} = (\alpha, (m-1)(k-1)) \quad (3)$$

where:  $\chi^2_{tab}$  - tabular (critical) value of  $\chi^2$  distribution at degrees of freedom; and  $\alpha$  - alpha at the significance level of 0.05.

We set the conclusion of the findings: (a) As long as  $\chi^2_{tab} > \chi^2$ , we accept the hypothesis H0 and reject the hypothesis H1; or (b) If  $\chi^2_{tab} < \chi^2$  holds, we accept hypothesis H1 and reject hypothesis H0.

If fact (b) occurs, we investigate the strength of dependence by Pearson coefficient:

$$c = \sqrt{\frac{x^2}{n + x^2}} \quad (4)$$

where:  $C$  - Pearson coefficient;  $x^2$  - test characteristic; and  $n$  - number of observations examined. The Pearson coefficient reaches a value in the range  $<0,1>$ , applies the rule, that the higher the value is, the higher is the dependency strength between the variables which are investigated.

### Hypothesis No.1

*H0: There is no difference in respondents' preferences when purchasing in packaging-free shop.*

*H1: There is difference in respondents' preferences when purchasing in packaging-free shop.*

## 4 THE RESULTS

We can summarize the results of our survey as follows.

Tab. 1 – SWOT analysis shop Váž si in Žilina. Source: own research

Strengths	weight	value	weighted value	Weaknesses	weight	value	weighted value
•bio quality products	0,2	3	0,6	•only 50% of Slovak food	0,2	2	0,4
• socially / environmentally responsible company	0,5	4	2	• consumers' ignorance of this type of sales	0,3	3	0,9
• good location	0,3	2	0,6	• incomplete product range coverage	0,5	4	2
<b>sum</b>	1		3,2	<b>sum</b>	1		3,3
<b>Opportunities</b>				<b>Threats</b>			
•sale also outside stores such as: festivals, events, etc.	0,15	1	0,15	• competition (Do vrecúška)	0,5	4	2
•business development	0,25	2	0,5	•legislative restrictions	0,3	2	0,6
•the use of a "hole" in the market	0,3	4	1,2	• new company on the market	0,2	3	0,6
• possible segment growth	0,3	3	0,9				
<b>sum</b>	1		2,75	<b>sum</b>	1		3,2

The SWOT analysis of the retail sector in accordance with Table 1 provides information on its strengths, weaknesses and opportunities, respectively threats. As strengths we consider it to be ecologically oriented retail, organic products and good location. Until recently, there was no other packaging business in the Žilina region. As weaknesses, on the other hand, we consider

the incomplete coverage of the assortment compared to the normal trade, only about 50% of Slovak food. We also consider the disadvantage of consumers' ignorance of this type of sales. She sees her opportunities as business development, improvement and presentation of her shop at festivals or other local and non-local events. Also the use of a “hole” on the market or a possible increase in the overall segment. The biggest threat we consider is the newly opened wrapping shop in Žilina called Do vrecúška. Another threat is legislation, which is gradually being amended and should be a minor threat for the future. And as a final threat, we consider it to be a new sales concept that not all consumers may have to accept positively. According to SWOT analysis we have developed a defensive strategy. This means that it is a strong enterprise in an unfavourable environment. It should use this strong position to block dangers such as intimidating competitors.

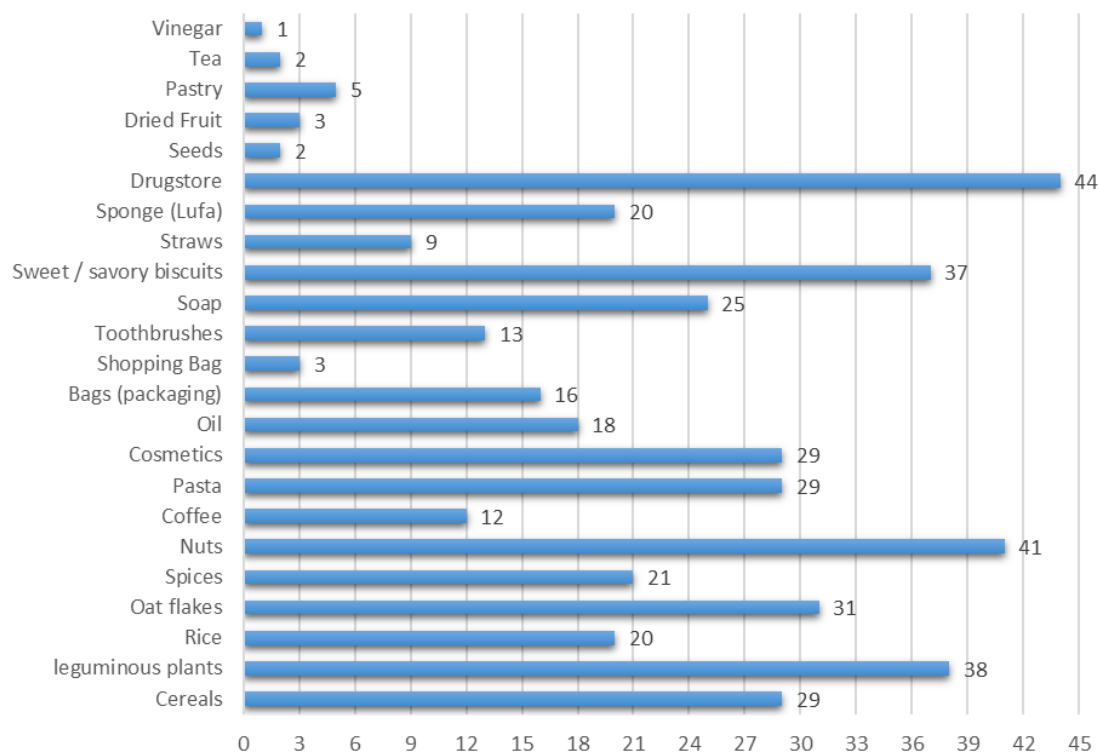

Fig. 1 – Purchased goods by respondents. Source: own research

As this type of shop is still not extensive in terms of product range, we wanted to know what was missing there. From Figure 2 we know that up to 40 respondents said they would welcome fresh fruit or vegetables. 12 stated that vegetables, respectively fruit was welcomed at least in dried form. Dairy products, vegan products, or gluten-free products to satisfy customer specificities would also be welcome to satisfy the customer in a packaging-free shop. What is positive is that up to 36 respondents said they were satisfied with the assortment in the shop they visited.

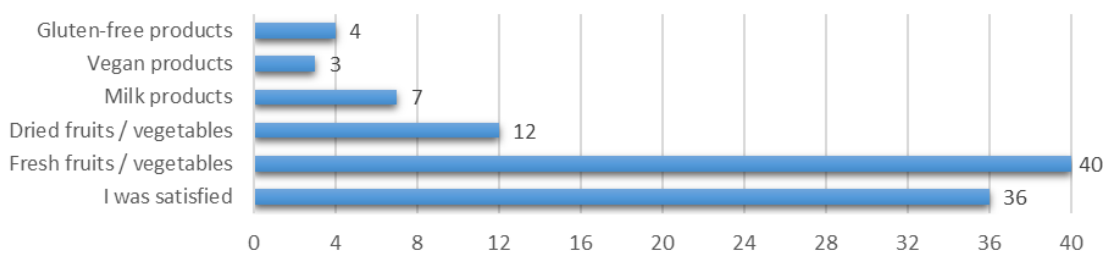

Fig. 2 – What was missing from the respondent in the packaging business. Source: own research

In order to know what is the strongest factor that can influence a customer when buying in a packaging shop, we asked about 6 different factors. From Figure 3 we know that the most important was the ecological aspect that up to 75 respondents placed first. The second most important factor was the origin of the products in the shop, and this was stated by up to 35 respondents. The third most important factor was the quality of the products, which was reported by up to 43 respondents. The less influential factor was the price, which was in 4 place. This was led by 25 respondents. The penultimate factor was curiosity, which was answered by 43 respondents that it would affect it for purchases in a packaging shop. Ad placed last. This was the least influencing factor of all. Up to 68 respondents stated that advertising could not influence them enough to buy into a packaging shop.

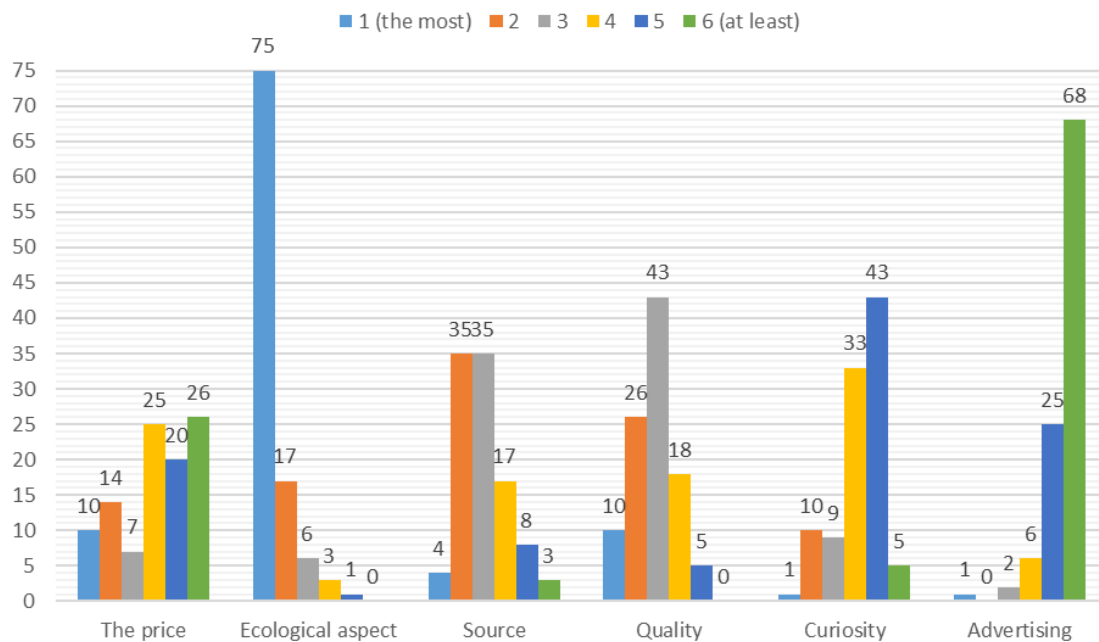

Fig. 3 – Factors affecting buying in a packaging shop. Source: own research

In order to know what is the strongest factor that can influence a customer when buying in a packaging shop, we asked about 6 different factors. From Figure 3 we know that the most important was the ecological aspect that up to 75 respondents placed first. Ad placed last. This was the least influencing factor of all. Up to 68 respondents stated that advertising could not influence them enough to buy into a packaging shop.

### Hypothesis No.1

*H0: There is no difference in respondents' preferences when purchasing in packaging-free shop.*

*H1: There is difference in respondents' preferences when purchasing in packaging-free shop.*

According to the calculations:

Tabular Value (TAB) - 11.07049769

Test Characteristics (F) - 2411.778711

According to Friedman's test, if  $F > TAB \Rightarrow H_0$  is rejected and we accept  $H_1$ , so there is difference in respondents' preferences when purchasing in packaging-free shop.

**Based on statistical testing of hypotheses, we found the following facts:** (a) Fresh fruit / vegetables - the survey shows us that consumers want these products the most; (b) Milk / dairy products - the survey shows us that consumers want these products the most; (c) Raising

awareness of this type of sales and attracting customers - viewed as a form of shopping experience that has been modern in recent times and is sought by consumers. Keeping them aware that by purchasing food and other products in a packaging-free shop, they contribute to sustaining the environment; (d) Workshops on zero waste topics for the environment - to spread awareness to the wider public through other activities; (e) Own blog - where the owner of an unpackaged store would introduce new products and her own advice, and the types of products she offers; and (f) Increase the % of Slovak products to the maximum - for example beans and other foodstuffs that can be grown in the SR not to be imported.

**Based on the questionnaire survey we learned the following basic information about the consumer's attitude towards packaging-free sales:** We asked question to find out what the respondents bought in the given time. From Figure 1 we see that 44 respondents reported buying drugstores and 29 cosmetics. Nuts are also very popular, 41 respondents said they bought them there. The least sold assortment was vinegar, tea, bread, shopping bag, seeds or dried fruit. It is very popular to buy various sponges, nicknamed "loofah", straws or bags, which are then used to buy. Also salty, respectively sweet biscuits reported by up to 37 respondents. Spices are a very interesting assortment. They bought up to 29 people in the packaging shop as well as pasta. Oil was bought by 18 respondents, and coffee by 12 respondents. Rice was bought by 20 respondents and oatmeal by 11 more.

## 5 CONCLUSION AND DISCUSSION

Unattended sale of medicines in our conditions is possible from new trends that allow the application of the application at market risk. One of the goals for paper was to summarize theoretical knowledge, which focuses on new trends in the distribution and sale of food in Slovakia. Subsequently, we characterized a new trend chosen by us: "packaging-free sales". Using a questionnaire survey that was designed to identify primary data and then evaluate the purchase in this type of retail. We found out what respondents are buying, what they miss and which factors would influence them to buy in this type of business.

From the questionnaire survey, we know that the ecological factor is the most influential for customers to buy in this type of store and least of all advertising. We also know that most lacked fresh and dried fruits / vegetables, gluten-free products or dairy products. However, consumers buy most drugstore, nuts, leguminous plants, sweet / salty cookies.

So our next step will be to improve the questionnaire survey, find another packaging shop that will work with us and compare it to ours, which we had the opportunity to explore. We recommend further exploring this issue from different perspectives such as: ecological footprint, respondents' opinions from other countries, legislative barriers, state support in this type of sales, consumers' willingness to shop in this way and so on.

### References

- Baco, P. (2010). *Podnikanie v poľnohospodárstve: zborník z odbornej celoslovenskej konferencie*, Nitra. Nitra: Agroinštitút.
- Beňová, M. (2019). *Môžeš si zobrať vlastné obaly do supermarketu? Známe reťazce predstavili ekologické kroky*. Bratislava: Ringier Axel Springer SK. Retrieved from <https://noizz.aktuality.sk/enviro/supermarkety-a-eko-iniciativy/1qy0csb>
- Dalíková, D. (2013). *Společenská odpovědnost podniku a vytváření sdílené hodnoty*. Paper presented at INPROFORUM 2013: Zdroje a limity ekonomického růstu a předpoklady

vývoje české ekonomiky, České Budějovice. České Budějovice: Jihočeská univerzita v Českých Budějovicích.

Goel, R. (2017). Emerging Trends in Sales Promotion in FMCG Sector in India. *International Journal of Business Administration and Management*, 7(1), 141-149. Retrieved from [https://www.ripublication.com/ijbamspl17/ijbamv7n2spl\\_13.pdf](https://www.ripublication.com/ijbamspl17/ijbamv7n2spl_13.pdf)

Kárpáti, L., & Lehota, J. (2007). *Agrármarketing*. Debrecen: DE AMTC AVK.

Kita, J. et al (2017). *Marketing*. Bratislava: Wolters Kluwer.

Nagyová, L. et al. (2018). *Marketing II*. Nitra: SPU Nitra.

Nagyová, P. (2017). *Drogeriu Vám načapujú, múku nasypú do vrecka, obchodom bez obalov sa aj u nás začína dariť*. Bratislava: N Press. Retrieved from <https://dennikn.sk/846794/drogeriu-vam-nacapuju-muku-nasypu-do-vrecka-obchodom-bez-obalov-sa-aj-u-nas-zacina-darit/>

Rovný, P., Nagyová, L., Stávková, J., Hes, A., Hesková, M., Čerkav, J., Skopřeva, L., Kretter, A., & Tlčík, V. (2007). *Zborník z medzinárodnej vedeckej konferencie: Marketing v teórii, výskume a praxi*, Nitra. Nitra: SPU Nitra.

TASR (2019). *Konečne. Vláda chce podporovať bezobalové obchody a tak predchádzať zbytočnému odpadu*. Banská Bystrica: INTEREZ MEDIA. Retrieved from <https://www.interez.sk/konecne-vlada-chce-podporovat-bezobalove-obchody-a-tak-predchadzat-zbytocnemu-odpadu/>

Vaňák, M. (2011). *Základy marketingu*. Praha: Vysoká škola finanční a správní.

## Contact information

### **Ing. Rebecca Brodňanová**

Slovak University of Agriculture in Nitra, Faculty of Economics and Management

Tr. A. Hlinku 2, 94976, Nitra, Slovak Republic

E-mail: [rebecca.brodnanova@gmail.com](mailto:rebecca.brodnanova@gmail.com)

ORCID: 0000-0003-0974-8173

### **Ing. Marek Plachý**

Slovak University of Agriculture in Nitra, Faculty of Economics and Management

Tr. A. Hlinku 2, 94976, Nitra, Slovak Republic

E-mail: [xplachym@uniag.sk](mailto:xplachym@uniag.sk)

ORCID: 0000-0001-7457-4451

doi: 10.7441/dokbat.2019.013

# CONVERGENCE OF EMPLOYMENT AND UNEMPLOYMENT RATES OF TERTIARY EDUCATED IN NUTS 3 REGIONS OF THE CZECH AND SLOVAK REPUBLIC

*Patrik Bulko, Katarína Škrovánková, Júlia Kostrová*

## Abstract

The employment and also unemployment of tertiary educated graduates is an object of interest and also research of many social groups across the national and also international spectrum. In this study, we focus on employment and unemployment of tertiary educated graduates in individual NUTS 3 regions of the Slovak and Czech Republic. The data obtained from Statistical Office of the Slovak Republic and also Czech Statistical Office were compared and used by method of Beta convergence, where all the regions were divided into four quadrants, through which we observed their mutual convergence. The correlation diagrams point to the location of the region Prešovský, Banskobystrický, Bratislavský, Košický (Slovakia) and Moravskoslezský, Olomoucký, Jihomoravský, Zlínský and Hl. město Praha (Czechia) in the first quadrant – with above-average initial value and above-average growth value related to unemployment of tertiary educated graduates. On the other hand, related to employment of tertiary educated graduates, the first quadrant was represented by Slovak regions Bratislavský and Prešovský, in conditions of the Czech Republic by Středočeský, Hl. město Praha, Jihomoravský and Moravskoslezský. The third quadrant – with below-average value and below-average growth value was represented in both measurements by Trnavský and Nitriansky region (Slovakia) and by Liberecký, Pardubický, Královéhradecký and Karlovarský region (Czechia).

*Keywords:* Higher education institutions, employment, unemployment, convergence, tertiary education

## 1 INTRODUCTION

Graduates (in our case tertiary educated) employability, as well as their un-employability is an object of investigation by many authors, as well as many scientific studies around the world. Gottlichova (2016) writes, that the high youth unemployment rate is really becoming a serious problem of the European Union as the population keeps aging. On the other hand, we have to say, that an increasing demand occurs for employees with higher qualifications ensuring a certain level of the key competencies to university graduates from the side of employers.

Adámek and Dobrylovský (2018) write, that in the Czech Republic and also in the European Union, can be seen a direct proportion between the education and ability to find employment. On the other hand, authors have found also opposite situation – in the south of Europe, the unemployment of the youthful (15-24) is above 50% (mainly in Spain), where this percentage makes more than 30% of the total unemployment – so, tertiary education increases employment rate of youthful, but not in the same range (differences can be seen among economical, technical, medical and art specialization).

Tertiary education in the Czech Republic (also in the Slovak Republic) is traditionally offered by Higher Education Institutions (HEI) – on the ISCED 5A and also 6 levels (these may either be of university or non-uni institutions). In 2009, the Czech government negotiated the White Book of tertiary education and provide a conception basis for the legislative changes in the tertiary education (Prokop, 2011).

A national concept for European Union countries can be fully found in the strategy of Europe 2020, which indicates the priorities for the future – related to European higher education system. The target is clear – 40% of people aged 30-34 in the European Union with higher education qualification by 2020. Matěju and Večerník (2015) mention that success depends mostly on graduates' competencies, including professional qualifications and skills.

Hahm and Kluge (2019) point out the importance of EU member states meeting in Bologna (Italy). They agree upon the creation of a common higher education area. The main intention was to initiate a harmonization process, with the objectives to improve international competitiveness of the European higher education system, to increase mobility among university staff and students, and also to enhance student's employability.

## **2 LITERATURE REVIEW**

Gottlichova (2016) deals with an idea, that the tertiary education becomes the fundamental source of the workforce for research, as well as for innovations and development. It is necessary – mainly for university graduates – to be able to positively present the essential knowledge and skills. Today's graduates will need to understand that their attitude to work is really important (as the work itself). Furthermore, their willingness and also ability to undertake professional development and hard training throughout their professional working life will be a pre-requisite for lifelong work (Aida, Norailis and Rozaini, 2015).

Sumanasiri, Yajid and Khatibi (2015) discuss about the most important graduates employability skills model, which was presented by Cotton in 1993. This model identifies a collection of basic, higher order and effective employability skills required by employers. These skills were categorized into three types – basic skills, higher skills, higher order thinking skills, traits and affective skills. This model is considered by many as one of the earliest models of employability – based on the notion, that employability depends on the skill levels of the individual, without any mention of factors such as behaviour, attitude etc.

In the labour market, employers mainly look for a range of skills in graduates' applicants – many of which are quite common to a number of different areas. Communication, team working, leadership, problem-solving, flexibility and also enthusiasm are the most frequently mentioned, as well. Many of these skills overlap with one another which is also known as context per se, mentioned Aida, Norailis and Rozaini (2015).

The connection between universities and the world of works is becoming ever more important. If employers can trust graduates – that their skills learned at universities are transferable from one university to another and from one country to another country, they have a bigger pool of graduates to recruit from (Puhakka, Rautopuro, Tuominen; 2010).

Gottlichova (2016) thinks, that the young generation, entering the labour market with a very low degree of education have to facing the greatest unemployment risk. In today's world - success in the competitive environment of the world market means high-quality workforce. Aida, Norailis and Rozaini (2015) also think, that the lack of soft skills and durability besides the attitudinal selective jobs tend to turndown employers of taking the graduates into their workplace. It is also important to say, that graduate employability program has become an increasingly important platform to produce quality employees for the competitive labour market. On the other hand, Maršíková (2015) points out of key role of higher education in maintaining economic growth via common governmental policies in countries that encourage participation in tertiary education. Many countries allocate a considerable budgeted for education from public resources.



A significant increasing number of university graduates brings a lot – but not only positive effects. For example, a lot of people in the labour market have to face a big problems with educational and skills mismatches, as same as on lower returns on investment for their education. At the end is needed to write, that university degree has become a very serious issue that needs to be solved as soon as possible, but not only by politicians – also by the complexity of the entire system of public and private higher education.

As many authors debate, the Bologna process has required universities to concentrate even more and more on employability. This concept of employability can be found in all main documents of the Bologna process. Higher education institutions were given very clear guidelines to pay more attention to the all needs of the labour market, write Puhaka, Rautopuro, Tuominen (2010).

What is also important, due to studies of many authors is two phenomena – over-education and job mismatches (one of the main reasons of unemployment). Over-education could be defined as a situation in which an individual has more education that the current job requires (CEDEFOP). On the other hand, under-education is a situation in which an individual has less education than the current job requires. Maršíková (2015) is sure, that the importance of a tertiary education in developed countries – in her opinion is a crucial topic for governments, individuals and also employers. Literature in the past proved the high importance of investing into education for all these subjects pointing out positive effects on them.

### 3 DATA AND METHODOLOGY

The main aim of this study is to characterize convergence of employment and unemployment rates of tertiary educated in NUTS 3 regions of the Czech and Slovak Republic, as same as pointing out of tertiary educated graduates rates (in general). For the purpose of our study, we will use data from Statistical Office of the Slovak Republic (SOSR) and also Czech Statistical Office (CZSO).

Due to SOSR and CSO - NUTS 3 (Nomenclature of Territorial Units for Statistics) are a codes of the regions. Czech Republic is divided into 14 regions: Prague (Hlavné město Praha), Southwest/Southeast (Jihočeský/Jihomoravský), Karlovy Vary (Karlovarský), Hradec Králové (Královohradecký), Liberec (Liberecký), Moravian-Silesian (Moravskoslezský), Olomouc (Olomoucký), Pardubice (Pardubický), Plzeň (Plzeňský), Central Bohemian (Středočeský), Ústí nad Labem (Ústecký), Vysočina (Vysočina), Zlínský (Zlín). Slovak Republic is divided into 8 regions: Bratislavský, Trnavský, Trenčiansky, Nitriansky, Žilinský, Banskobystrický, Prešovský, Košický.

For the calculation of the convergence of regions, we used  $\beta$  convergence method.

$$\frac{1}{T} \log \left( \frac{y_{i,t_0+T}}{y_{i,t_0}} \right) = \alpha - \left( \frac{1-\epsilon^{-\beta T}}{T} \right) \log(y_{i,t_0}) + u_{i,t_0,t_0+T} \quad (1)$$

where:  $\alpha$  – Constant;  $t$  – Lower index (year);  $i$  – Lower index (Region);  $y_{it}$  – (Income) in Reg. at the beginning of the year;  $y_{it+T}$  – (Income) in Reg. at the end of the year;  $u_{it}$  – Variation

The correlation diagram divides the monitored regions into four quadrants using two lines. The quadrants run through average values. Characterization of the individual quadrants: (1) Regions with above-average initial value and above-average growth value; (2) Regions with below-average initial value and above-average growth rate; (3) Regions with below-average initial value and below-average growth rate; and (4) Regions with above-average initial value and below – average growth rate.

## 4 RESULTS AND DISCUSSION

In this part of our study, we will primarily refer to the general level of tertiary education in both countries, as same as on the rates of unemployment and employment of HEI graduates.

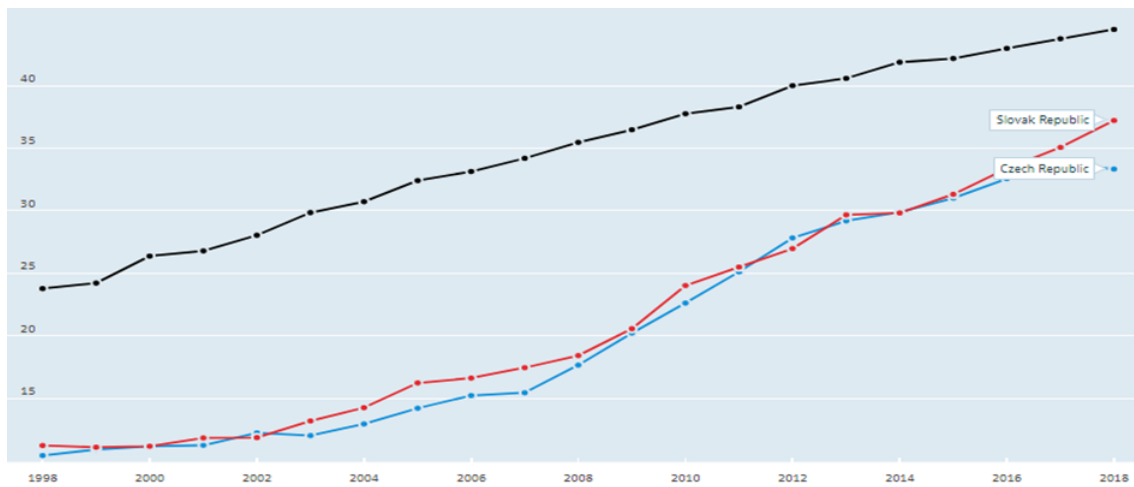

Fig. 1 – Tertiary educated (1998-2017). Source: OECD (2019)

Figure 1 shows the development of tertiary education rates in the Czech and Slovak Republic. This figure also includes the OECD average of the tertiary education level of the population. In relation to the monitored and measured values between 1998 and 2018, we can observe a significant increase in the education level of graduates of both countries (including also OECD values). In the Czech Republic, the share of tertiary educated in the first reference year was 10.5%, in the Slovak Republic this percentage was higher – 11.3%. However, the OECD average was significantly higher – 23.8%. At the end of the period under review, the ratio of monitored indicator is incomparably higher – the Czech Republic = 33.3%, the Slovak Republic = 37.2 %, the average of OECD countries = 44.5%.

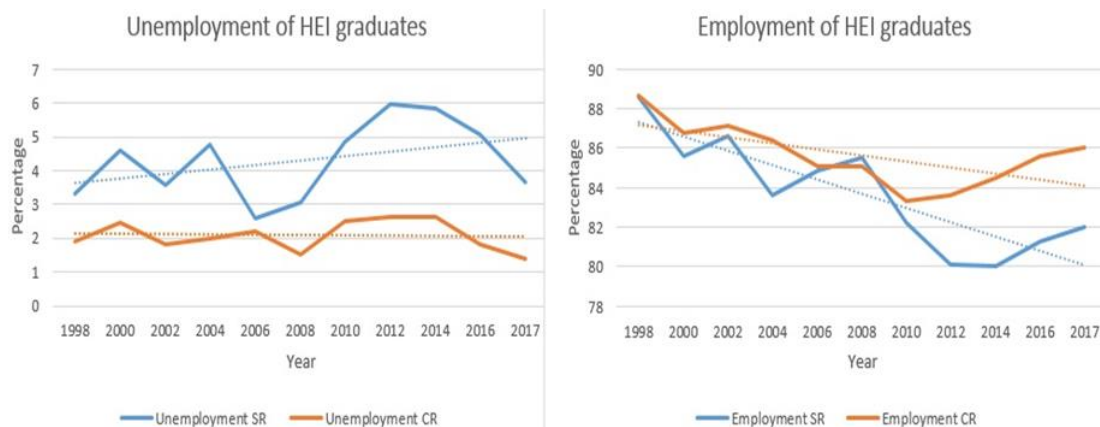

Fig. 2 – Unemployment and employment rates of HEI graduates. Source: CZSO (2019), SOSR (2019)

Figure 2 shows, in two-year cycles, the unemployment rate as well as the employment rate of HEI graduates. In both views, we compare the data in the Slovak and Czech Republic. In relation to the unemployment rate of tertiary educated, we can observe non-constant values, which differ significantly in comparison with both countries (as indicated by the increasing or stagnating linear trend). The data presented in this figure is a basic prerequisite for the calculation of convergence (divergence) of individual regions in relation to the subject of our study.

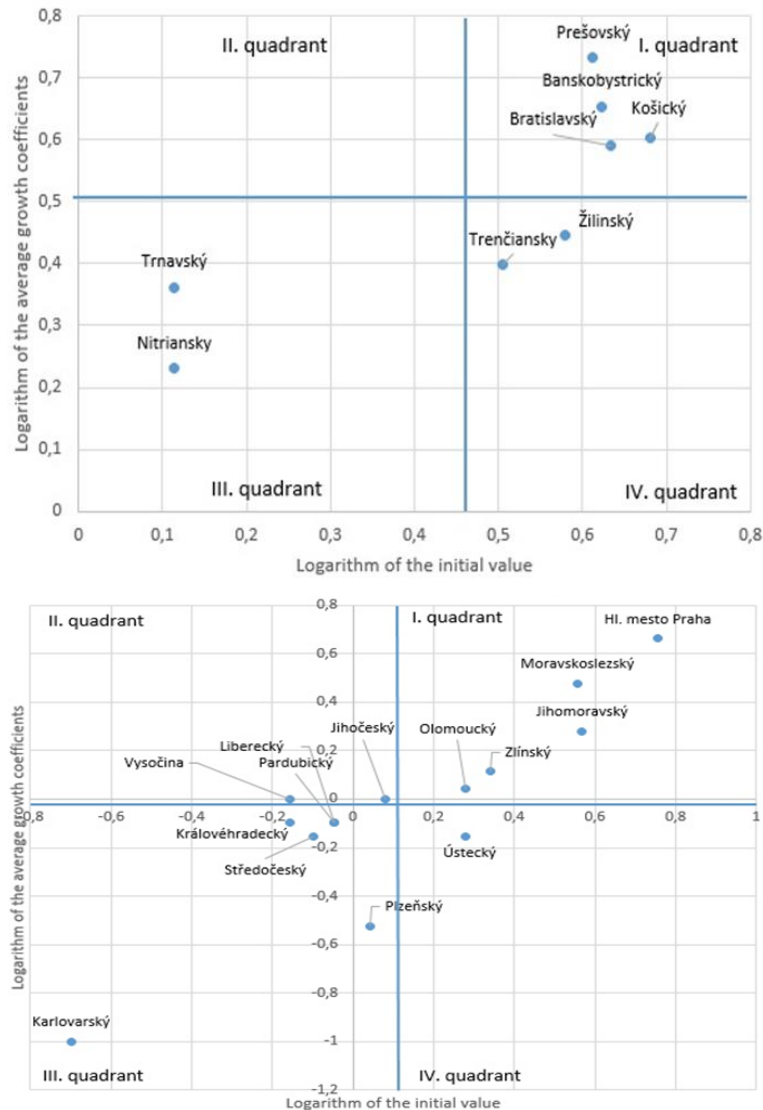

Fig. 3 – Correlation diagrams – unemployed HEI graduates. Source: CZSO (2019), SOSR (2019)

As shown in a previous Figure 3 – correlation diagram of Slovak and also Czech Republic, the regions are divided into 4 quadrants (regarding to unemployed HEI graduates). In the first quadrant are Slovak regions Prešovský, Banskobystrický, Bratislavský and Košický. These regions are with an excessive initial value of unemployed graduates. These regions, as same as Czech regions in 1. quadrant (HI. mesto Praha, Moravskoslezský, Jihomoravský Olomoucký and Zlínský) have tend to move away from others. They showing above average logarithm of initial values, but also above average logarithm of average graduate growth rate.

In the second quadrant are regions with below average beginning value and with above average growth rate. They have tend to move into the space of the first quadrant. There are only Czech regions – Jihočeský and Vysočina. Third quadrant is represented by regions with lower average growth rate (Trnavský and Nitriansky in Slovakia and Královéhradecký, Středočeský, Liberecký, Plzeňský, Karlovarský and Pardubický in Czechia). These regions have tend to stagnate, as they show a below-average logarithm of the initial value, but also a below-average logarithm of the average growth factor. Generally, these regions should have the greatest need to correct an unsatisfactory condition. In the fourth quadrant regions shows above average initial values, but also a below-average growth rate (Trenčiansky and Žilinský in Slovakia and Ústecký in Czechia).

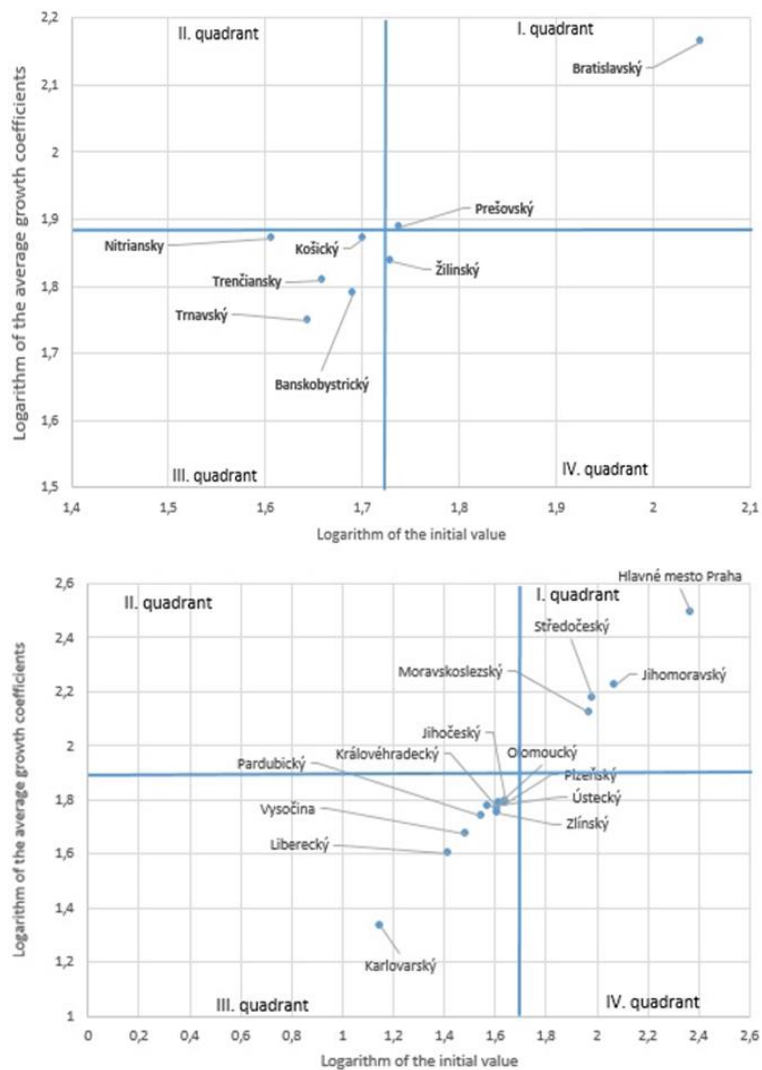

Fig. 4 – Correlation diagrams – employed HEI graduates. Source: CZSO (2019), SOSR (2019)

Figure 4 represents a convergence chart of Slovak and also Czech Republic, where the regions are also divided into 4 basic quadrants (regarding to employed HEI graduates). In the first chart quadrant are Slovak regions Prešovský and Bratislavský. These regions are with an excessive initial value of employed graduates. These regions, as same as Czech regions in 1. quadrant (Hl. mesto Praha, Moravskoslezský, Jihomoravský and Středočeský) have tend to move away from others. They showing above average logarithm of initial values, but also above average logarithm of average graduate growth rate.

In the second quadrant are regions with below average beginning value and with above average growth rate. They have tend to move into the space of the first quadrant. In our case, none of the regions surveyed is in the third quadrant. Third quadrant is represented by regions with lower average growth rate (Košický, Nitriansky, Trenčiansky, Trnavský and Banskobystrický in Slovakia and Zlínský, Ústecký, Plzeňský, Olomoucký, Jihočeský, Královéhradecký, Pardubický, Vysočina, Liberecký and Karlovarský in Czechia). These regions have tend to stagnate, as they show a below-average logarithm of the initial value, but also a below-average logarithm of the average growth factor. In the fourth quadrant regions shows above average initial values, but also a below-average growth rate. This quadrant is represented only by Žilinský region.

## 5 CONCLUSION

Jonck (2014) write about global trends – such as increasing vocationalism, marketization and mainly mass education between universities. Higher education is consequently under increasing pressure to validate its expenditure on the development of graduates' skill and to show its relevance in the knowledge economy. It is easy to fully understand, why employability of tertiary graduates has been lifted among the core concepts (main role) in the professional debate among authors and also population, as well. As the labour market changing – and also is flexible, tertiary graduates employability means, that they have to have skills that are transferable from one occupation to another (and also vice versa – related to graduates un-employability).

Sumanasiri, Yajid and Khatibi (2015) discuss, that employability and un-employability of tertiary graduates depends not only on the attributes of the individual graduates such as experience, skills, subject knowledge, personality traits – but also on the curriculum, faculty, pedagogy in university system, finally on the employers who hire the graduates and their expectations. The main purpose of contemporary tertiary education is to ensure graduates gain a comprehensive education that increase the likelihood of gaining and sustaining employment, with benefits to all stakeholders including the economy (Jonck, 2014).

In our study, we pointed out of convergence of employment and unemployment rates of tertiary educated in NUTS 3 regions of the Czech and Slovak Republic. Related to correlation diagram of regional unemployment of HEI graduates in conditions of both countries – Prešovský, Banskobystrický, Bratislavský and Košický region/ Moravskoslezský, Hl. město Praha, Jihomoravský, Zlínský, Olomoucký (regions located in first quadrant) – have tend to diverging from other regions. Regions located in second quadrant – Jihočeský and Vysočina (none in Slovakia) have tend to move into the first quadrant. Third quadrant is represented by Trnavský, Nitriansky and Královéhradecký, Středočeský, Liberecký, Pardubický, Plzeňský and Karlovarský region. These regions have tend to lag behind other regions. Fourth quadrant, represented by Žilinský, Trenčiansky and Ústecký region have tend to move into the third quadrant. On the other hand, due to correlation diagram of regional employment of HEI graduates in conditions of both countries, we can conclude that the most represented is third quadrant, where fifteen out of twenty-two regions are situated here.

### References

- Adámek, P., & Dobrylovský, J. (2018). *Tertiary education as the prevention of youthful unemployment in the Czech Republic*. Paper presented at 12th International days of statistics and economics, Prague. Prague: University of Economics, Prague.
- Aida, B., Norailis, A. W., & Rozaini, R. (2015). Critical Success Factor of Graduate Employability Programs. *Journal of Economics, Business and Management*, 3(8), 767-771. doi: 10.7763/JOEBM.2015.V3.283
- Cedefop (2010). *The skill matching challenge: Analysing skill mismatch and policy implications*. Luxembourg: European Union.
- CZSO (2019). *Czech Statistical Office database*. Retrieved from <https://www.czso.cz>
- Gottlichova, M. (2016). *The cohesion and competitiveness of the European Union in the area of the tertiary education: The qualification – The innovation – The Employment*. Paper presented at 9th International conference of education, research and innovation, Seville. doi: 10.21125/iceri.2016.1128

- Hahm, S., & Kluve, J. (2019). Better with Bologna? Tertiary education reform and student outcomes. *Educational Economics*, 27(4), 425-449. doi: 10.1080/09645292.2019.1616280
- Jonck, P. (2014). A Human Capital Evaluation of Graduates from the Faculty of Management Sciences Employability Skills in South Africa. *Academic Journal of Interdisciplinary Studies*, 3(6), 265-274. doi: 10.5901/ajis.2014.v3n6p265
- Maršíková, K. (2015). The value of a university degree in the European context: The case of part-time students in the Czech Republic. *Economics and Sociology*, 8(3), 260-271. doi: 10.14254/2071-789X.2015/8-3/18
- Matěju, P., & Večerník, J. (2015). Kompetence, vzdělání a lidský kapitál v České republice ve světle dat OECD. *Politická ekonomie*, 63(2), 185-203. doi: 10.18267/j.polek.996
- OECD (2019). Population with tertiary education. Retrieved from <https://data.oecd.org/eduatt/population-with-tertiary-education.htm>
- Prokop, J. (2011). *Tertiary education in the Czech Republic – trends and reform*. Paper presented at 4th International conference of education, research and innovation, Madrid. Retrieved from <https://library.iated.org/view/PROKOP2011TER>
- Puhakka, A., Rautopuro, J., & Tuominen, V. (2010). Employability and Finnish University Graduates. *European Educational Research Journal*, 9(1), 45-55. doi: 10.2304/eerj.2010.9.1.45
- SOSR (2019). *Statistical Office of the Slovak Republic database*. Retrieved from <http://datacube.statistics.sk>
- Sumanasiri, E. G. T., Yajid, M. S. A., & Khatibi, A. (2015). Review of Literature on Graduate Employability. *Journal of Studies in Education*, 5(3), 75-88. doi: 10.5296/jse.v5i3.7983

## Contact information

### Ing. Patrik Bulko

Alexander Dubček University in Trenčín, Faculty of Social and Economic Relations  
 Študentská 3, 91150, Trenčín, Slovak Republic  
 E-mail: Patrik.bulko@tnuni.sk  
 ORCID: 0000-0002-6910-7434

### Ing. Katarína Škrovánková

Alexander Dubček University in Trenčín, Faculty of Social and Economic Relations  
 Študentská 3, 91150, Trenčín, Slovak Republic  
 E-mail: katarina.skrovankova@tnuni.sk  
 ORCID: 0000-0002-8295-9666

### Ing. Júlia Kostrová

Alexander Dubček University in Trenčín, Faculty of Social and Economic Relations  
 Študentská 3, 91150, Trenčín, Slovak Republic  
 E-mail: Julia.kostrova@tnuni.sk  
 ORCID: 0000-0002-0536-0318

doi: 10.7441/dokbat.2019.014

# LONG-TERM IMPACT OF BREXIT ON AUSTRIAN ECONOMY – SINGLE COUNTRY CGE MODEL

*Lukáš Burian*

## **Abstract**

Brexit is unprecedented case of a country which wants to leave European Union. No one really knows how Brexit will look like in reality or how will it affect both United Kingdom and countries of European Union. In this paper we simulated possible long-term impact of the Brexit on Austrian economy. UK officials try to bargain better deal with the EU and they repeatedly mention that the impact of the Brexit will be stronger on the countries inside EU than on the UK itself. We used ORANI-G CGE (computable general equilibrium) model where we simulated the effect of increased tariff rates with the UK. ORANI is a simple single county model where we were able to simulate increased tariffs on the UK's imports to Austria and also to simulate shift in demand for Austria's export (due to change in UK tariff rates). We determined that the impact of Brexit on Austrian economy would be insignificant in the long-run. Following macro-effects are visible: GDP, consumption and government spending drop about 0.1%, and real investment around 0.24%. Austria's tariff revenue increased in this scenario by around 79 million euros. The biggest impact on the Austrian economy come from drop in the export demand.

*Keywords: Brexit, CGE model, macroeconomics, European Union, United Kingdom, Austria*

## **1 INTRODUCTION**

From the referendum in 2016 United Kingdom is on its path to leave European Union and the common market. This is historic moment as the UK is the first country to ask to leave the EU. Since 2016 EU and UK are negotiating on what the so-called Brexit should look like and how would trade between the UK and countries inside the EU continue after the Brexit. According to the Ministry of Foreign and European Affairs of the Slovak Republic there are two possible scenarios: (1) Deal – the UK will respect the norms and regulations imposed by the EU, but the UK can use the single market within EU and its Customs union with third countries; or (2) No deal (Hard Brexit) – the UK will no longer respect EU norms and regulations, The UK will no longer be part of a single market with its four freedoms (freedom of movement of goods, persons, services and capital) and of the Customs union. As a part of the negotiations UK officials are stating that the impact of Brexit will be more severe for individual countries within EU than for the UK itself. Of course, there is no definite understanding on what Brexit entails.

Brexit is a unique event with no precedent it is not possible to do a normal forecast in which a few assumptions are made about a limited range of exogenous variables. The best that can be done is to construct scenarios (Gudgin, Coutts & Gibson, 2016). In this paper we will try to simulate impact of hard Brexit on Austrian economy in long-run and analyse if the impact will be so shocking for single economy. In our simulation we presume that the only change is that the UK will raise its tariffs on imports from the EU to be consistent with the EU's MFN applied duties. Likewise, EU member countries will raise their tariffs on imports from the UK to be consistent with the EU's MFN tariffs (Eurostat, 2019).

## 2 DATA AND METHODOLOGY

In this paper we were working with ORANI-G model along with GTAP data base. The ORANI applied general equilibrium (AGE) model of the Australian economy has been widely used by academics and by economists in the government and private sectors. We used a generic version of the model, ORANI-G, designed for expository purposes and for adaptation to other countries.

Figure 1 is a schematic representation of the model's input-output database. It reveals the basic structure of the model. The column headings in the main part of the figure (an absorption matrix) identify the following demanders: (1) Domestic producers divided into I industries; (2) Investors divided into I industries; (3) Single representative household; (4) Aggregate foreign purchaser of exports; (5) Government demands; and (6) Changes in inventories.

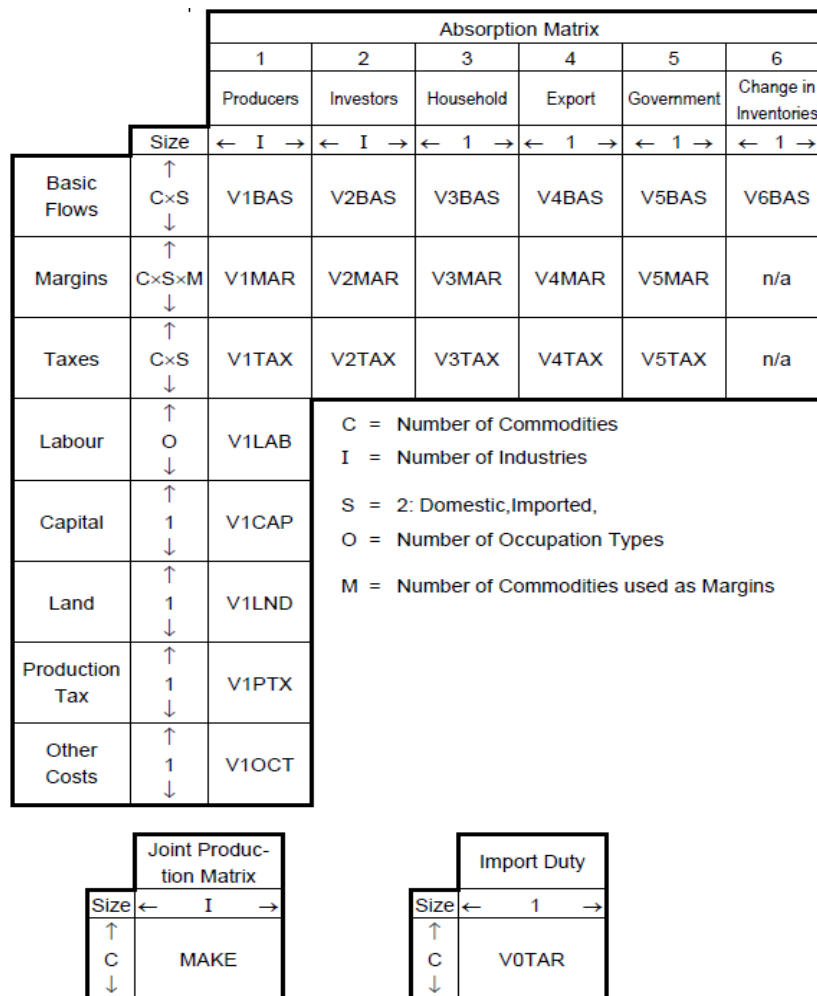

Fig. 1 – The ORANI-G flows database. Source: own research

The GTAP Data Base is a consistent representation of the world economy for a pre-determined reference year. Underlying the data base there are several data sources, including among others: national input-output (I-O) tables, trade, macroeconomic, energy and protection data. The underlying input-output tables are heterogeneous in sources, methodology, base years, and sectoral detail, thus for achieving consistency, substantial efforts are made to make the disparate sources comparable. For these reasons, the objective of the GTAP Data Base is not to provide I-O tables, but to facilitate the operation of economic simulation models ensuring users a consistent set of economic facts. (GTAP, 2019)



### **3 LONG-RUN CLOSURE IN THE ORANI-G MODEL**

There is no definite understanding of what Brexit entails. In this paper we simulate the effects of Brexit, presuming that the only change is that the UK will raise its tariffs on imports from the EU to be consistent with the EU's MFN applied duties. Likewise, EU member countries will raise their tariffs on imports from the UK to be consistent with the EU's MFN tariffs (Eurostat, 2019). Usually, we think how various macro-economic variables (on the supply side and demand side of GDP) might be determined.

#### **3.1 LONG-RUN variables**

##### **Supply side: Labour market**

In the long run, it is often argued that aggregate employment is determined by demographic variables, participation rates and the natural rate of unemployment. The assumption that, in the long run, the national employment level is determined by population growth, labour force participation rates and the natural rate of unemployment, is the standard steady-state (i.e. long-run) assumption of most modern macro econometric models. These variables are unrelated to the trade shocks imposed by Brexit. In simulations with fixed employment in the long run, the real wage rate must be free to adjust.

##### **Supply side: Capital formation**

Because we are concerned with the long run, we wish to allow for capital relocation effects in our simulations. For example, in simulating the effects on the metal products industry of the tariff changes, we wish to allow the metal products industry's capital stock to deviate from its base level. To allow for capital mobility, we assume that industry rates of return on capital do not deviate from their base levels. Initially, different tariff shocks in different industries will put varying pressures on rates of return in industries. We assume that these cause a change in capital formation sufficient to keep rates of return at their initial levels. We can justify the rate of return/capital stock assumptions by appealing to small country arguments. With no restrictions on international flows of financial capital, Austrian industries face perfectly elastic supply-of-funds schedules in the long run.

##### **Demand side: Investment**

We assume that, in the long-run solution year, the percentage deviation from base in industry  $j$ 's investment is the same as the percentage deviation in industry  $j$ 's capital stock. With no restrictions on the supply of investment funds at the given rates of return, it is possible that the nation-wide level of capital formation will change. Therefore, if we tie investment in each industry to changes in each industry's capital formation, it is possible (when aggregating across industries) that the nationwide level of investment has changed. This means we need to endogenize the aggregate level of investment. Typically, the swap is with the in slack variable.

##### **Demand side: Trade balance and private consumption expenditure**

One assumption that can be made is our shocks have no long-run effects on the trade balance. That is, we assume that national expansions in income are matched by national expansions in absorption (GNE). Hence, the trade balance will be exogenous. With the trade balance, investment determined by capital formation and GDP determined by the supply side of the economy, private consumption expenditure and government expenditure is residually determined (i.e. it must be set endogenously). Figure 2 is schematic representation of the model's causation in long-run closure we used in our simulation.

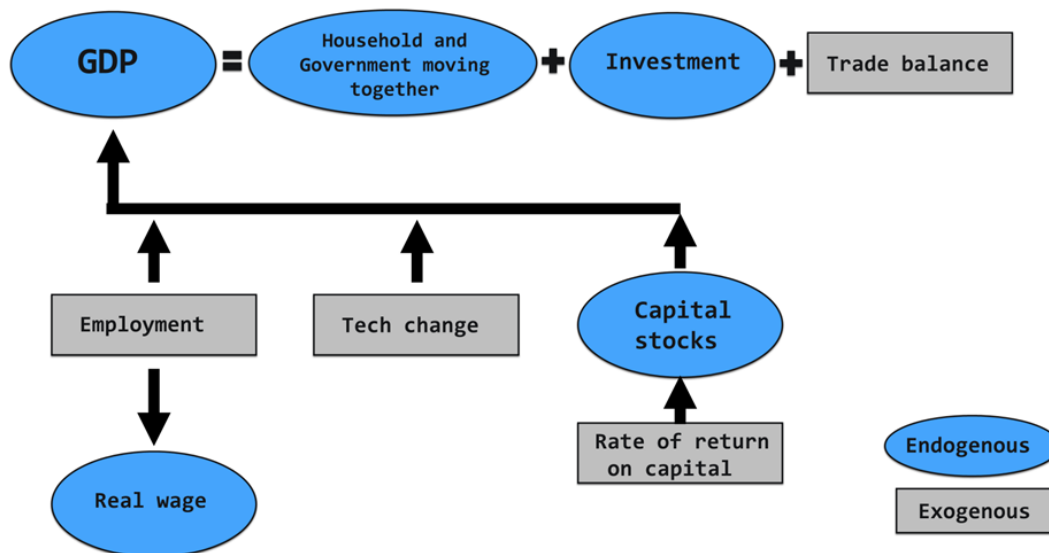

Fig. 2 – Causation in long-term closure. Source: Horridge (2000)

### 3.2 Simulating effect of the Brexit

In this paper we simulate the effects of Brexit, presuming that the only change is that the UK will raise its tariffs on imports from the EU to be consistent with the EU’s MFN applied duties. Likewise, EU member countries will raise their tariffs on imports from the UK to be consistent with the EU’s MFN tariffs. To understand what happens in this case we need to shock both import from the UK to Austria and shock Austria’s export to the UK. To simulate change in import in our model we shock each commodity by change in the power of tariff. Because we are using a single country model, we do not know how much the UK will increase its tariffs (we do, but we do not simulate the UK in this model but Austria). To simulate the effect of their increased tariffs we need to shock different variable in our model. In general, we need to simulate shift in demand for Austria’s exports. (Eurostat, 2019)

## 4 RESULTS

Table 1 shows percentage change in main macro-economic variables, only change in tariff revenue is described in absolute change in millions of euro. As a result of the Brexit the following macro-effects are visible: GDP, consumption and government spending drop about 0.1%, and real investment around 0.24%. There is a small increase in tariff revenue coming from direct effects of tariffs. Household consumption and government spending are bound together in this model which is the reason why the change is the same. The effect of Brexit on Austria’s economy in the long-run is not significant. This is because the volume of UK’s import to the Austria is less than 1.6% of volume and Austria’s export to the UK is about 2.8% of total volume. ORANI provides function to separate effects of simultaneous shocks (as we did in our simulation). These effects are shown in Table 1 as “export shocks” and “import shock”. We can see that the export shock is more significant than the import shock in this case. The biggest changes come from drop in the export demand. Export shock is more significant in this scenario because total volume of export to UK is higher than volume of import from the UK. Both shocks reflected on domestic market which shrank for most industries. We can observe switch towards domestic products, which does not compensate for the loss in the export demand. This model does not take into account possible shift of export towards other member states in European Union, which could decrease the negative effects even more.

Tab. 1 – Change in main macro-economic variables. Source: own research

Variable	Change	Export shock	Import shock
Aggregate tariff revenue (absolute change)	79.106	-1.096	80.202
Consumer price index	-0.06	-0.075	0.015
Average real wage	-0.155	-0.107	-0.048
Real GDP from expenditure side	-0.104	-0.077	-0.026
Aggregate real investment expenditure	-0.238	-0.174	-0.064
Real household consumption	-0.092	-0.088	-0.004
Aggregate real government demands	-0.092	-0.088	-0.004

## 5 CONCLUSION

In this paper we simulated effect of Brexit on Austria's economy in the long-run using ORAN-G model. UK officials are stating that the impact of Brexit will be more severe for individual countries within EU than for the UK itself as part of their negotiation techniques. We determined that the impact of Brexit on Austria will not be as brutal as UK officials are predicting. That corresponds with findings of various authors who used different methods to simulate effect of Brexit on member states of the EU and UK itself such as Ebell and Warren (2016) or Gudgin et al. (2018). We used simple single country model to simulate the effects. In this case we did not consider the effect of increased tariff revenues on Austria's economy and we could not simulate the possible shift of import and export towards other countries within European Union. This could be simulated using more advanced multi regional model which would take other member states of EU into consideration. This model would require far more data for its database. On the other hand, in more advanced model where Austria's export could shift more towards other member states of EU, results could differ. The impact of the Brexit on Austria could be even smaller or even positive if shift in export would lead to more effective market partners within EU.

### Acknowledgement

This contribution is the result of the project VEGA (1/0393/16) Európska únia v pokrízovom období - makroekonomické a mikroekonomické aspekty.

### References

- Ebell, M., & Warren, J. (2016). The long-term economic impact of leaving the EU. *National Institute Economic Review*, 236(1), 121-138. doi: 10.1177/002795011623600115
- Eurostat (2019). *International trade in goods - tariffs*. Eurostat: Statistics Explained. Retrieved from [ec.europa.eu/eurostat/statistics-explained/index.php/International\\_trade\\_in\\_goods\\_-\\_tariffs](http://ec.europa.eu/eurostat/statistics-explained/index.php/International_trade_in_goods_-_tariffs)
- Gudgin, G., Coutts, K., & Gibson, N. (2016). The Macro-Economic Impact of Brexit: Using the CBR Macro-Economic Model of the UK Economy (UKMOD). *Working Paper No. 483*. Cambridge: Centre for Business Research, University of Cambridge. Retrieved from [http://www.cbr.cam.ac.uk/fileadmin/user\\_upload/centre-for-business-research/downloads/working-papers/wp483revised.pdf](http://www.cbr.cam.ac.uk/fileadmin/user_upload/centre-for-business-research/downloads/working-papers/wp483revised.pdf)
- Gudgin, G., Coutts, K., Gibson, N., & Buchanan, J. (2018). The macro-economic impact of Brexit: using the CBR macro-economic model of the UK economy (UKMOD). *Journal*

*of Self-Governance and Management Economics*, 6(2), 7-49. doi:  
10.22381/JSME6220181

GTAP (2019). *GTAP Data Bases: GTAP 10 Data Base*. Global Trade Analysis Project. Retrieved from <https://www.gtap.agecon.purdue.edu/databases/v10/index.aspx>

Horridge, M. (2000). ORANI-G: A General Equilibrium Model of the Australian Economy. *Working Paper Number 93*. Melbourne: Centre of Policy Studies. Retrieved from [www.copsmodels.com/elecprpr/op-93.htm](http://www.copsmodels.com/elecprpr/op-93.htm)

MZVSK (2009-2018). *BREXIT: Všeobecné informácie*. Ministerstvo zahraničných vecí a európskych záležitostí Slovenskej republiky. Retrieved from <https://www.mzv.sk/europske-zalezitosti/brexit>

### Contact information

#### **Ing. Lukáš Burian**

University of Economics in Bratislava, Faculty of National Economy

Dolnozemska cesta 1, 85235, Bratislava, Slovak Republic

E-mail: [lukas.burian@euba.sk](mailto:lukas.burian@euba.sk)

ORCID: 0000-0002-3404-455X

doi: 10.7441/dokbat.2019.015

# ELECTRIC CARS FOR SMARTER CITIES: REGRESSION MODEL

*Arunas Burinskas*

## **Abstract**

The study is given to the use of dynamic regression model for the improvement of infrastructure for electric cars. Purpose of research is the use of a dynamic regression model to identify the influence of chargers to the number of electric cars. To reach the goal, the author focuses on the improvement of availability of chargers and the minimisation of distance between charging points. Research methodology is based on the application of dynamic regression method to forecast the park of electric cars in Lithuania. The author suggests a dynamic regression model and accompanies it with autocorrelation and heteroskedasticity tests: Breush-Godfrey Serial Correlation LM Test for autocorrelation and ARCH test for heteroskedasticity. During analysis author identifies the relationship between the number of chargers and the number of electric cars. The author delivers a specific regression model to estimate the improvement of chargers' infrastructure on the park of electric cars. Probability F and Probability Chi-Square of this testing show that there is no significant autocorrelation and heteroskedasticity. Presented framework could be useful for practitioners, which forecast the number of electric cars in cities. The presented regression model could be used for forecasting the expansion of park of electric cars in Lithuania.

**Keywords:** *electric car, stations, smarter city, infrastructure, regression, model*

## **1 INTRODUCTION**

By 2017, 262 million cars had been registered in 28 EU Member States. Within 4 years the park of electric cars had been significantly growing. The number of cars with electricity had been reached 2 million and, comparing with 2013, the increase in number, which had been reported, was jumped than seven times (Eurostat, 2019).

Charging infrastructure is critical because the number of electric cars is growing and there are increasing number of fully electric vehicles or hybrid ones. There are several business models for charging electric cars: charging stations and swapping battery. These will be presented in the paper under the literature review to gather knowledge and interpretations. Charging stations construct hubs and are essential for smart cities.

Most of public charging points are in urban areas. For example, the Netherlands have 32 000 stations for charging the park of 119 000 electric vehicles, but Greece has only 40 public charges which serves more than 300 electric cars. It is suggested that charges must be located in distance of 60 kilometers (European Parliament, 2019). For the transformation of cities into the smart cities it is important to have customer centric infrastructure and services provided for the mobility of residents.

The literature review highlights business models available for cars with electricity that could be in combination with other engine, such as petrol or diesel or without. The paper presents case study of Lithuania cities, which apply the business model of charging stations. Author constructed regression model forecasting the park of electric cars, which can be driven on single engine, and following the city infrastructure of charges. Author suggests binary regression equation and accompanies it with autocorrelation and heteroskedasticity tests. The study also identifies the availability of charges and distance covered on charge in Lithuania. Finally, the paper gives concluding remarks and further directions of research. The research results show

that there is no significant autocorrelation and heteroskedasticity and that the regression model is applicable in practice seeking to forecast grow in the number of electric cars.

## 2 LITERATURE REVIEW

The demand for charging point and electric vehicles is analysed by scientists and is given in different models. Charging infrastructure scenarios in gridded city assumes long-term grid costs required for old and new infrastructure. These models focus on finding the suitable location for the instalment of charging stations. Model of metropolitan governance is used for comparative analysis and incorporates municipality functions into them. The model is the framework for metropolitan decisions for dealing with public problems.

There are many patterns of business models presented in the literature: car-sharing, battery swapping, vehicle-to-grid, public charging, intermodal choice, etc. (Laurischkat, Viertelhausen & Jandt, 2016). Vehicle quantity sub-model represents the output of qualitative choice and probability analysis. The model of path dependence behaviour is developed by scientists to explain the adoption of electric vehicles.

The demand of electric vehicles is analysed in Vehicle demand models. Herein, Multinomial probit models are used to foresee the choice of vehicles. Vehicle holding and transaction models focus on costs to own and use the car, the model could be incorporated into simulation as framework to forecast demand of those cars. Finally, the model of travel mode choice defines the preference of household and the number of cars preferred by household.

Tab. 1 – Models given infrastructure and vehicle choice analysis. Source: own research

Category	Analysis	Models	Authors
Infrastructure	Charging infrastructure scenarios in gridded city	Simulation	Chen, Kockelman & Hanna (2016); Von Meier (2018)
Infrastructure	Model of metropolitan governance	Transaction costs model	Lowery (2000)
Infrastructure	Electric mobility business models	Holistic instrument	Kley, Lerch & Dallinger (2011); Knapen et al. (2012); Madina, Zamora & Zabala (2016)
Vehicle	Vehicle quantity sub model	Probability	Brownstone et al. (1996)
Vehicle	Path-dependent behavior model	Revenue/cost model	Bohnsack, Pinkse & Kolk (2014)
Vehicle	Vehicle demand models	Model of Crow and Ratchford; Multi-nomial probit model	Brownstone et al. (1996)
Vehicle	Vehicle holding and transaction models	Simulation	Brownstone et al. (1996)
Vehicle	Models of travel mode choice	Preference models	Brownstone et al. (1996)

Author foresees that there is no link drawn between the charging infrastructure and the park of electric vehicles by models presented on Tab. 1. To solve this, author present analysis of such linkage. Below quantitative modelling is performed.

### 3 METHODOLOGY

The research relies on two variables: one is representing the number of fully electric cars available in the park of Lithuania cities and the second one - the number of stations located at eleven cities of Lithuania for charging electric cars. For the analysis author uses the recent data from September 2019, collected from the registry of cars for eleven cities (Regitra, 2019) and from the web site providing the list on publicly available chargers (Elektrodegalines, 2019).

The author delivered specific regression model, which formulation is:

$$a = \beta_0 + \beta_1 st \quad (1)$$

The equation is presenting t statistics and graphical output of regression model with actual, residual and fitted values.

Two tests were delivered: Breush-Godfrey Serial Correlation LM Test for autocorrelation and ARCH test for heteroskedasticity. Probability F and Probability Chi-Square of this testing shows that there is no significant autocorrelation and heteroskedasticity. Finally, author provided the output of regression model and the results of the tests. During the research author uses EView statistical package.

After the regression model, was defined, the author constructed distance matrix for charges. For each charging station author has figured out Latitude and Longitude dimensions. Afterwards, the distance between each pair is calculated as determined in Tab. 2.

Tab. 2 – Models given infrastructure and vehicle choice analysis. Source: own research

Charger	C <sub>1</sub> (Lat <sub>1</sub> , Lon <sub>1</sub> )	C <sub>2</sub> (Lat <sub>2</sub> , Lon <sub>2</sub> )	...	C <sub>n</sub> (Lat <sub>n</sub> , Lon <sub>n</sub> )
C <sub>1</sub> (Lat <sub>1</sub> , Lon <sub>1</sub> )	–		...	
C <sub>2</sub> (Lat <sub>2</sub> , Lon <sub>2</sub> )		–	...	
...	...	...	...	...
C <sub>n</sub> (Lat <sub>n</sub> , Lon <sub>n</sub> )			...	–

To calculate the distance among the chargers' locations, author applied such equation:

$$d = ACOS \left( \begin{aligned} &COS(RADIANS(90 - Lat_1)) * COS(RADIANS(90 - Lat_2)) \\ &+ SIN(RADIANS(90 - Lat_1)) * SIN(RADIANS(90 - Lat_2)) \\ &* COS(RADIANS(Lon_2 - Lon_1)) \end{aligned} \right) * 6371 \quad (2)$$

After the distances are calculated between each pair of charging stations, distance matrix is provided.

### 4 REGRESSION MODEL

This regression equation delivered such results:

$$a = 1.30 + 1.67 st$$

(1.61) (2.63)

The correlation coefficient is equal to 0.66 and the R squared of the regression is 0.43. The output of regression model is provided below in Fig. 1.

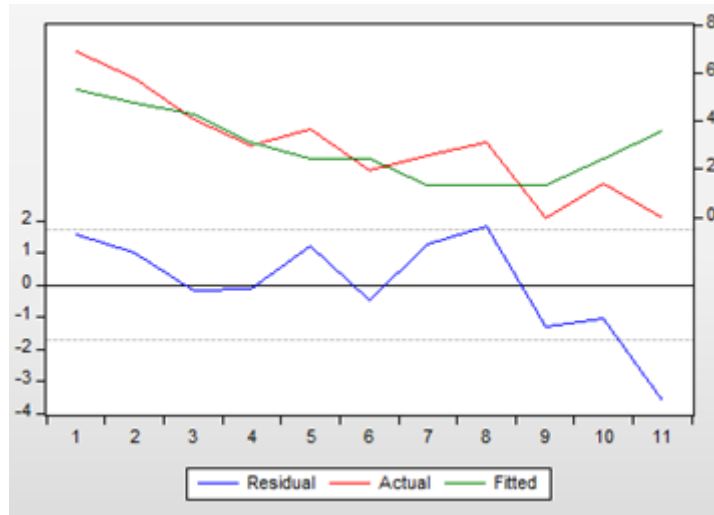

Fig. 1 – The output of regression model. Source: own research

In Fig 1, the red line represents original number of electric cars, while the green line demonstrates the modelled number according to the estimated equation; the blue line shows residuals of the regression model.

Author has also testing statistics for autocorrelation and heteroskedasticity. Following tests were provided: for autocorrelation analysis – Breusch-Godfrey, for heteroskedasticity analysis – ARCH test and ML ARCH - Normal distribution (BFGS / Marquardt steps) test. Probability F and Probability Chi-Square of these testing statistics shows that there is no significant autocorrelation and heteroskedasticity. The more detailed results of the dynamic regression analyses are presented in the Annex of the paper.

The distance matrix was constructed by using Eq. 2 to revise the distance between chargers. Below is presented distance matrix specifying the location of charging stations. The summarized data is placed in Table 3.

Tab. 3 – Distance matrix for charges. Source: own research

Kilometers, d	Number of charging pairs	Percentage
0-49	145	19%
50-99	207	27%
100-149	157	20%
150-199	124	16%
200-249	52	7%
250-299	94	12%

From the Tab. 2 author could resume that 19 percentage of chargers are in less than 50 kilometres distance as European Parliament (2019) recommends it. In total 46 percentage of chargers are in less than 100 distance. Some electric cars have the option to be charged in 100 kilometres distance. Finally, 70 percentage of charging stations are in distance lower than 180 kilometres. There are random number of electric vehicles which trip between chargers could be 180 kilometres. However, there are no cars with other travelling capabilities except battery swapping cases. The distance analysis shows that the location for charges is not very well selected and the density of charges must be improved.



## 5 CONCLUSION

There are many different models used to predict the demand of charging stations and electric vehicles. These models employ simulation, probability, multinomial probit and other techniques. Binary regression is not yet used for such modelling analysis. The empirical study proved that proposed regression model is applicable in practice seeking to forecast the park expansion of electric cars in Lithuania cities. Two probabilities F and Chi-Square were used to test autocorrelation and heteroskedasticity during modelling and provided the output with positive results. The distance analysis shows that more than half of public chargers connecting smart cities are in the distance, which is not acceptable by electric cars. This proves the necessity of more charging points, which must be installed to cover density requirements.

The research could be expanded to other directions, like to test provided framework for urban cases in other countries; revise the application of regression model for hybrid cars park analysis; economic analysis of infrastructure and the ownership of electric vehicles; and the research of trips for sample cars.

### References

- Bohnsack, R., Pinkse, J., & Kolk, A. (2014). Business models for sustainable technologies: exploring business model evolution in the case of electric vehicles. *Research Policy*, 43(2), 284-300. doi: 10.1016/j.respol.2013.10.014
- Brownstone, D., Bunch, D. S., Golob, T. F., & Ren, W. (1996). A transactions choice model for forecasting demand for alternative-fuel vehicles. *Research in Transportation Economics*, 4, 87-129. doi: 10.1016/S0739-8859(96)80007-2
- Chen, T. D., Kockelman, K. M., & Hanna, J. P. (2016). Operations of a shared, autonomous, electric vehicle fleet: Implications of vehicle & charging infrastructure decisions. *Transportation Research Part A: Policy and Practice*, 94, 243-254. doi: 10.1016/j.tra.2016.08.020
- Elektrodegalines (2019). *The list of electric charging stations*. Retrieved from <http://elektrodegalines.lt>
- Eurostat (2019). *Eurostat news: Number of electric cars is on the rise*. Retrieved from <https://ec.europa.eu/eurostat/web/products-eurostat-news/-/DDN-20190507-1?inheritRedirect=true>.
- European Parliament (2019). *Briefing: Electric road vehicles in the European Union Trends, impacts and policies*. Retrieved from [http://www.europarl.europa.eu/RegData/etudes/BRIE/2019/637895/EPRS\\_BRI\(2019\)637895\\_EN.pdf](http://www.europarl.europa.eu/RegData/etudes/BRIE/2019/637895/EPRS_BRI(2019)637895_EN.pdf)
- Kley, F., Lerch, C., & Dallinger, D. (2011). New business models for electric cars: A holistic approach. *Energy Policy*, 39(6), 3392-3403. doi: 10.1016/j.enpol.2011.03.036
- Knapen, L., Kochan, B., Bellemans, T., Janssens, D., & Wets, G. (2012). Activity-based modeling to predict spatial and temporal power demand of electric vehicles in Flanders, Belgium. *Transportation Research Record*, 2287(1), 146-154. doi: 10.3141/2287-18
- Laurischkat, K., Viertelhausen, A., & Jandt, D. (2016). Business models for electric mobility. *Procedia CIRP*, 47, 483-488. doi: 10.1016/j.procir.2016.03.042.

- Lowery, D. (2000). A transactions costs model of metropolitan governance: Allocation versus redistribution in urban America. *Journal of Public Administration Research and Theory*, 10(1), 49-78. doi: 10.1093/oxfordjournals.jpart.a024266
- Madina, C., Zamora, I., & Zabala, E. (2016). Methodology for assessing electric vehicle charging infrastructure business models. *Energy Policy*, 89, 284-293. doi: 10.1016/j.enpol.2015.12.007
- Regitra. (2019). *Number of vehicles registered in the register by category and type of fuel by region*. Retrieved from <https://www.regitra.lt/lt/atviru-duomenys/>
- Von Meier, A. (2018). *EV Infrastructure Planning and Grid Impact Assessment: A Case for Mexico*. Retrieved from <http://www2.eecs.berkeley.edu/Pubs/TechRpts/2018/EECS-2018-70.html>

## Contact information

### Arunas Burinskas

Vilnius University, Faculty of Economics and Business Administration  
 Sauletekio av. 9, II Building, 10222 Vilnius, Lithuania  
 E-mail: burinskas.arunas@gmail.com  
 ORCID: 0000-0001-6053-9495

doi: 10.7441/dokbat.2019.016

## Appendix

### Formation of equation (1)

Equation: UNTITLED    Workfile: STOT::dd\

View Proc Object Print Name Freeze Estimate Forecast Stats Resids

Dependent Variable: LOG(AUTO)  
 Method: Least Squares  
 Date: 10/04/19 Time: 21:09  
 Sample: 1 11  
 Included observations: 11

Variable	Coefficient	Std. Error	t-Statistic	Prob.
LOG(ST)	1.666274	0.633281	2.631174	0.0273
C	1.301047	0.806816	1.612570	0.1413

R-squared	0.434783	Mean dependent var	2.942091
Adjusted R-squared	0.371981	S.D. dependent var	2.142034
S.E. of regression	1.697512	Akaike info criterion	4.059170
Sum squared resid	25.93393	Schwarz criterion	4.131515
Log likelihood	-20.32544	Hannan-Quinn criter.	4.013567
F-statistic	6.923076	Durbin-Watson stat	1.007470
Prob(F-statistic)	0.027306		

### Analysis of errors normal distribution

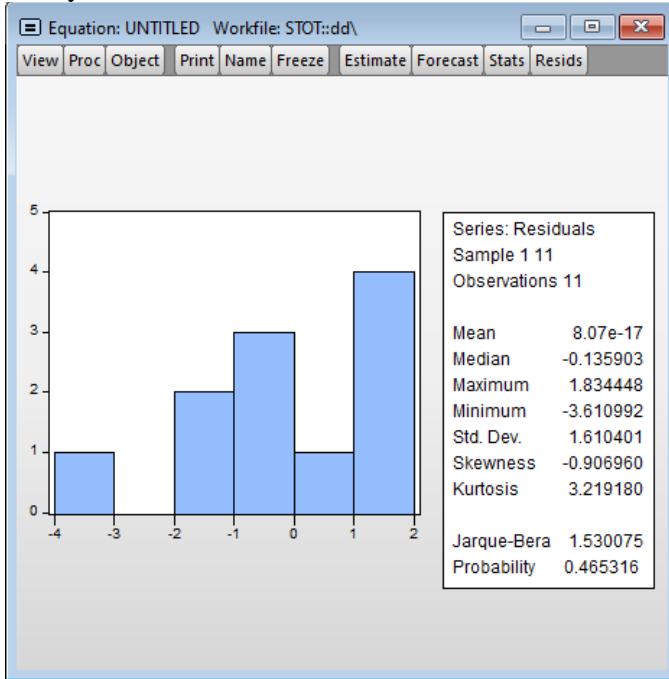

### Analysis of autocorrelation: Breusch-Godfrey test

Equation: UNTITLED Workfile: STOT::dd\

View Proc Object Print Name Freeze Estimate Forecast Stats Resids

**Breusch-Godfrey Serial Correlation LM Test:**  
Null hypothesis: No serial correlation at up to 4 lags

F-statistic	0.813018	Prob. F(4,5)	0.5673
Obs*R-squared	4.335008	Prob. Chi-Square(4)	0.3626

Test Equation:  
Dependent Variable: RESID  
Method: Least Squares  
Date: 10/04/19 Time: 21:19  
Sample: 1 11  
Included observations: 11  
Presample missing value lagged residuals set to zero.

Variable	Coefficient	Std. Error	t-Statistic	Prob.
LOG(ST)	-0.331904	0.718328	-0.462050	0.6635
C	1.479410	1.590531	0.930136	0.3950
RESID(-1)	0.190261	0.709228	0.268265	0.7992
RESID(-2)	-0.645428	0.776030	-0.831704	0.4435
RESID(-3)	-0.725918	1.004293	-0.722815	0.5022
RESID(-4)	-1.447092	0.957794	-1.510859	0.1912

R-squared	0.394092	Mean dependent var	8.07E-17
Adjusted R-squared	-0.211817	S.D. dependent var	1.610401
S.E. of regression	1.772771	Akaike info criterion	4.285416
Sum squared resid	15.71358	Schwarz criterion	4.502450
Log likelihood	-17.56979	Hannan-Quinn criter.	4.148607
F-statistic	0.650415	Durbin-Watson stat	1.566303
Prob(F-statistic)	0.675789		

Analysis of heteroskedasticity: ARCH test

Equation: UNTITLED Workfile: STOT::dd\				
View Proc Object Print Name Freeze Estimate Forecast Stats Resids				
Heteroskedasticity Test: ARCH				
F-statistic	0.003569	Prob. F(1,8)	0.9538	
Obs*R-squared	0.004459	Prob. Chi-Square(1)	0.9468	
Test Equation:				
Dependent Variable: RESID^2				
Method: Least Squares				
Date: 10/04/19 Time: 21:15				
Sample (adjusted): 2 11				
Included observations: 10 after adjustments				
Variable	Coefficient	Std. Error	t-Statistic	Prob.
C	2.253621	2.112922	1.066590	0.3173
RESID^2(-1)	0.077097	1.290514	0.059741	0.9538
R-squared	0.000446	Mean dependent var	2.353035	
Adjusted R-squared	-0.124498	S.D. dependent var	3.882784	
S.E. of regression	4.117396	Akaike info criterion	5.845176	
Sum squared resid	135.6236	Schwarz criterion	5.905693	
Log likelihood	-27.22588	Hannan-Quinn criter.	5.778788	
F-statistic	0.003569	Durbin-Watson stat	1.142040	
Prob(F-statistic)	0.953827			

# REVIEW OF METHODS FOR CIRCULAR SUPPLY CHAIN ANALYSIS: THE APPLICATION FOR OPTIMISATION STUDIES

*Aurelija Burinskiene*

## **Abstract**

The changing economic environment (the program of European Commission "Creating a Circular Economy - a Europe without Waste"), orientation in modernizing, reorganizing traditional supply chains, switching from "linear" to "circular" supply chain, optimizing material and energy consumption and reducing waste, are being studied more extensively by researchers since 2014. The circular supply chain is different from linear in that it links traditional linear processes with reverse logistics processes that include product recovery, product recycling, disassembly, and recycled product reuse. The emergence of the circular supply chain is a natural process in the evolution of the supply chain, but new challenges are now emerging, such as the seamless (non-fragmented) deployment and timing of the relevant functional logistics activities, since the circular supply chain covers more processes and requires optimization. A systematic analysis of scientific literature will be carried out, which will seek to identify scientific works related to the interpretation of the concept of circular supply chain. To gather knowledge about optimization studies, a review of recent publications literature is delivered by identifying scientific methods and quantitative methods used for circular supply chain analysis. Later, methods used for circular supply chain modelling are figured: mathematical programming methods, simulation methods, heuristic methods, hybrid models, and analytical models. After the descriptive analysis of scientific methods and quantitative models is performed, author proposes a set of meta-heuristic methods for optimizing the circular supply chain processes. Finally, conclusions and directions for further research are presented.

**Keywords:** *circular supply chain, optimization, methods, analysis, processes*

## **1 INTRODUCTION**

The changing economic environment and changes of organization's business processes also lead to changes in the extraction of materials, production, marketing and processing of products. In this context, many companies are modernizing and reorganizing traditional supply chains and switching from "linear" to "circular" to reduce material and energy consumption and waste (Nasir et al., 2017).

The emergence of the circular supply chain is a natural process in the evolution of the supply chain. However, the new challenges now emerge, such as the seamless (non-fragmented) deployment and implementation of the relevant functional logistics activities, since circular supply chain must ensure a continuous material movement cycle. The conventional circular supply chain cycles shorten leading in a faster cycle of material flows along the supply chain, including the collection, sorting and recycling of used products. Analysis of the topic-related scientific literature (Govindan, Jha & Garg, 2016; Manavalan & Jayakrishna, 2019) reveals the lack of research on optimizing the circular supply chain processes.

The paper reveals scientific methods and quantitative models used for the optimization of circular supply chain processes.

## **2 THE DEFINITION OF CIRCULAR SUPPLY CHAIN**

The supply chain is treated as traditional one or “linear” supply chain, which extracts resources from geosphere and biosphere and disposes off end-of-life products and materials and generates significant amount of waste. However, circular supply chain is constructed to support circular economy, which focus on waste minimization. Circular supply chain includes industrial and natural ecosystems. It systematically restores technical materials and regenerates biological materials toward zero waste generation through supply chain activities from product design to its end-of-life and utilization, involving all stakeholders in product lifecycle management, including producers of parts and product, service providers, consumers, and products’ users (Koh et al., 2017).

There are some definitions trying to name circular supply chain. Mainly these are reflecting the sustainability points, but these are not covering zero waste aspect. Researchers are attaching multi-dimensional aspects to sustainable supply chain analysis, like environmental, social and economic aspects. There are also studies focusing on green supply chain. The authors, which focus on green supply chain topic, give higher weight for environmental aspect and lower weight to economic aspects by leaving social aspect outside the boundaries. The concept of closed-loop supply chain is oriented to circular economy. It includes the ability of products and materials to become technical nutrients at the end of their life by applying repairing, refurbishment, re-production, and re-cycling activities. The definition of closed-loop supply chain takes two aspects of sustainability: environmental and economic ones. Closed-loop supply chain still generates some waste. When we speak about circular supply chain, we think about zero waste option (Pan et al., 2015; Nasir et al., 2017), which is expressed as the ability of products and materials to be transformed to biological nutrients at the end of their life. Further, they become the part of biosphere as natural materials, which could be reused during the production of new products.

In the context of supply chain and operations researches, circular supply chain is receiving increasing attention from 2014 and quite many research areas are not yet identified. Circular supply chain is different from linear supply chain in that it links traditional linear supply chain processes with reverse logistics processes that include product recovery, product recycling, disassembly, and recycled product reuse. Depending on how fast products are collected from consumers, reaches recycling sites, and how fast they are recycled, there are resource savings. The world's resources are limited and must be supplemented by all resources. For the saving of resources, the optimization techniques are important. This encourage researches in optimization area.

## **3 METHODS USED FOR MODELLING CIRCULAR SUPPLY CHAIN**

Over time, we can see an impressive growth of preoccupation in scientific community to analyse non-linear systems. Approaching of such systems mostly in mathematics and in natural sciences generated fundamentally new concepts and methods. In operations research, their application is only at the beginning and could be provided for analysing behaviour of distribution logistics as system. It could be used to examine whether resources are efficiently allocated and spells out the conditions for the optimal allocation of resources to maximize the output.

Authors apply the following methods for circular supply chain modelling: Network models, Decision theory, Inventory management models. Simulation models of discrete event (DES) and system dynamics (SD) are also be used. Various simulation methods are taken for optimization (Tab. 1). Some of these models are used for modelling supply chain, which is

researched by covering certainty and uncertainty aspects. The distinction between deterministic systems manifesting predictable behaviour and statistic series reflecting random or stochastic behaviour therefore unpredictable. Chaotic behaviour of these series is simple interpreted as being stochastic and in estimating linear models the inconvenient observations were classified as accidental.

Tab. 1 – Modelling of circular supply chain. Source: own research

Structural dimension	Analytical category	
Circular supply chain	Participants	Carrier, distributor, logistics service provider, manufacturer, wholesaler, retailer
	Level of analyse	Circuit, network (two-tier, multi-tier), function
	Processes	Logistics Network Design, Inventory Management, Demand Management, Return Management, Transport Routing
Modelling	Purpose of model	Descriptive - deterministic, descriptive - stochastic, normative - deterministic, normative - stochastic
	Model type	Mathematical programming methods, simulation methods, heuristic methods, hybrid models, and analytical models
	Modelling techniques	Artificial Intelligence, System Dynamics (SD), Discrete Event Modelling (DES), Systematic Models, etc.
	Solution method	Queuing models, Genetic algorithms (GA), Simulation (DES, ABS, SD), Particle Swarm Optimization, etc.

#### 4 MATHEMATICAL METHODS COVERED AND NOT COVERED

Many studies are provided on the topic of circular supply chain. Also, various methods have been applied, such as Mathematical programming models (MILP, Variations Inequality); Simulation (Systems dynamics, Discrete event); Artificial intelligence (Fuzzy logic, Neural networks); Analytical models MCDM (DEA); systematic models (Life Cycle analysis, Input/Output Analysis), but many of them are still not covered (Tab. 2).

According to the literature, mathematical programming methods are used for supply chain and sustainable supply chain analysis. The application of linear programming and queuing models is identified in the papers covering sustainable supply chain topic. The simulation methods, such spread-sheets and business games, are mainly used for supply chain researches. Simple heuristic method is applied in the area of sustainable supply chain. Artificial intelligence methods, like Petri net, Case base reasoning, Rough set are presented in studies which are analysing supply chain. Other artificial intelligence methods, such as Bayesian networks, Rough set are identified in research oriented to sustainable supply chain.

It is important to mention that meta-heuristic methods are not yet applied by authors for circular supply chain analysis. Meta heuristic methods (such as Particle Swarm Optimization, Ant Colony Optimization) are popular in supply chain studies. Notably, evolutionary, including genetic, algorithms are already recognized by the authors as suitable for supply chain optimization issues (Vergara, Khouja & Michalewicz, 2002). Other methods, like Simulated Annealing and GRASP are mentioned in studies dedicated for sustainable supply chain. Differential Evolution is taken for logistics management research, particularly for transport routing. Green supply chain analysis takes Rough set method, AHP/ANP methods, and Genetic algorithms. Hybrid models basically are used in studies oriented to circular economy. The same is with Metrics method from Systematic models. Game theory models are particularly identified in papers dedicated for the analysis of closed-loop supply chain.

All these above-mentioned models are covering forward and reverse flow analysis and environmental topics. Moreover, the circular supply chain could be research from various points of view. The studies especially focus on several methods applications, but new studies

could be provided considering methods used for researches interested in supply chain, sustainable supply chain, green supply chain, logistics management, closed-loop supply chain, and circular economy.

Tab. 2 – Hierarchy of qualitative methods and models. Source: own research

Model type	Model technique	Solution method	Authors researching
Mathematical programming method	Single objective	Linear programming	Bjork & Carlsson (2007)
	Multi-objective	MILP Goal programming Dynamic programming Queuing models Nonlinear programming Variations Inequality	
Simulation	Spread-sheet		
	Systems dynamics		Tsolakis & Srai (2017)
	Discrete event		Lieder et al. (2017)
	Business games		
Heuristic method	Simple heuristic		
	Artificial intelligence	Petri net Case based reasoning Bayesian networks Fuzzy logic Neural networks Rough set	Krikke et al. (2005)
	Meta heuristic	Genetic Algorithm Evolutionary Algorithm Differential Evolution Algorithm Particle Swarm Optimization Simulated Annealing Ant Colony Optimization Greedy Randomized Adaptive Search Procedure (GRASP)	
Hybrid models			
Analytical models	MCDM	DEA AHP/ ANP	Yu & Leng (2012)
	Systematic models	Life Cycle analysis Input/ Output Analysis Metrics	Nasir et al. (2017) Koh et al. (2017)
	Game theory		

#### 4.1 The application of meta-heuristic methods for processes optimization

There are many processes for which optimization authors apply meta-heuristic methods. Author has selected five processes for further analysis, such as the design of logistics network, inventory management, demand management, return management and transport management.

A classical network configuration problem involves large amount of data, including plants, customers, warehouses. Two techniques are included: mathematical optimization techniques, like exact algorithms, which find optimal solutions and heuristics, which deliver "good" solutions, but not necessarily optimal. In addition, simulation models that help to evaluate network design alternatives. Meta heuristic algorithms are search techniques that are used to deal with complex problems, which solving is difficult by applying traditional methods. Genetic algorithm is the oldest and most frequently used search technique.

Inventory management process covers planning and scheduling points. Inventory management determines optimal procedure for procurement of inventory to meet upcoming demand. If the nature of cost functions is non-linear, which practically happens in the situations of multi-



echelon, substitutable or perishable items, genetic algorithms could be a good choice in those situations to find optimal values. As such could be too complicated for traditional techniques.

Demand management process covers order patterns by frequency, size, season, and content. These patterns are investigated on the cluster of clients' bases. The mathematical form of demand function could be treated as complex one, which includes external and internal environmental factors important for demand forecasting. In such cases, evolutionary and or genetic algorithms allow to search for optimal solution.

Returns management process is associated with physical returns; reverse flow, gate assignment, and re-manufacturing, which represent the main activities of circular supply chain. The application of genetic algorithms is taken to overcome the complexity. The process of transport management employs genetic algorithms as the most-friendly technique. Many genetic algorithms specified in the papers are dealing with transport routing problems.

According to Tab. 2 meta-heuristic methods are not yet applied by authors for circular supply chain analysis. Meta heuristic search methods could be implemented for optimization of various processes. Genetic algorithms are widely applied from meta-heuristic methods. Beside Genetic Algorithms, the meta-heuristic methods include Evolutionary Algorithms, Differential Evolution Algorithms, Particle Swarm Optimization and other.

The summary of meta-heuristic methods applicable for the optimization of various processes by authors is provided below in Tab. 3.

Tab. 3 – The application of Meta heuristic methods for processes optimization. Source: own research

Methods	Processes				
	Design of logistics network	Inventory management	Demand management	Return management	Transport management
Genetic algorithms (GA)	Liu (2014); Chen (2014); Hernandez-Hernandez, Montoya-Torres & Niebles-Atencio (2014); Taha et al. (2014); Dzupire & Nkansah-Gyekye (2014); Rajendran, Devadasan & Kannan (2014); Ko, Ko & Kim (2006); Ko & Evans (2007); Lam et al. (2008); Li et al. (2013)	Chan, Chung & Wadhwa (2004); Chan & Chung (2004); Chang et al. (2006); Pourakbar, Farahani & Asgari (2007); Chi et al. (2007)	Kuo (2001); Lawrence & Pasternack (2002); Xu & Mao (2013); Zhang & Qinghe (2014); Devika et al. (2016); Jun & Qing (2015)	Rogers et al. (2002); Min, Ko & Ko (2006b); Min, Ko & Ko (2006a); Lieckens & Vandaele (2007); Trappey, Zhou & Min (2011); Diabat et al. (2013); Boudhar, Dahane & Rezg (2013); Ghezavati & Nia (2014)	Liu, Jiang & Geng (2014); Pierre & Zakaria (2017); Mohr (2014); Kumar et al. (2014); Zhang & Li (2014); Psychas, Marinaki & Marinakis (2015); Cai, Tang & Yang (2015); Karakatic & Podgorelec (2015); Ahmadizar, Zeynivand & Arkat (2015)
Evolutionary algorithms (EA)	Tiwari et al. (2016); Pishvae, Farahani & Dullaert (2010); Shankar et al. (2013); Shukla et al. (2010)	Tsou (2009); Devika et al. (2016); Lee et al. (2008); Olsen (2008)	Bandyopadhyay et al. (2008)	Kumar et al. (2017)	Erbao & Mingyong (2009); Tan, Cheong & Goh (2007); Tan, Chew & Lee (2006)
Differential evolution algorithms (DE)	Doolun et al. (2018); Emdadian, Ponnambalam & Kanagaraj (2018)		Wang et al. (2012)		Wang & Weise (2010)
Particle swarm optimisation (PSO)			Coello, & Lechuga (2002)		Ai & Kachitvichyanukul (2009); Marinakis & Marinaki (2010)

Herein, for the design of logistics network three main methods are used: Genetic algorithms, Evolutionary Algorithms, and Differential Evolution Algorithms. For the inventory management process the first two methods: Genetic algorithms and Evolutionary Algorithms are taken. The same methods are also applied for return management studies. For the processes of demand management and transport management authors use Genetic Algorithms, as well as

Evolutionary Algorithms, Differential Evolution Algorithms, and Particle Swarm Optimization. The authors applying the above-mentioned algorithms are listed in the Table 3.

Based on the analysis outcome, it is proposed to use meta-heuristic methods for revising the optimization of circular supply chain processes. The literature review of five processes shows that authors more commonly use Genetic algorithms and Evolutionary algorithms in optimization analysis. This proves that these two meta-heuristic methods are suitable for circular supply chain optimization studies.

## 5 CONCLUSION

The research on circular supply chain is recently ongoing. Even authors are incorporating some quantitative methods in their analysis; the research potential on circular supply chain topic is quite large. The literature analysis shows that studies on linear supply chain, sustainable, green and closed-loop supply chains are incorporating many methods, which are not taken yet for circular supply chain case. In addition, the main algorithms, which are widely applied for the optimization of processes and still not considered for the circular supply chain research.

In contrary to other topics, circular supply chain is incorporating zero waste aspect, which requires more advanced researches. Moreover, the length of supply chain processes is important when limited natural resources are considered. The optimization of circular supply chain processes must be highlighted by researchers. Due to that, author suggests for optimization analysis to apply meta heuristic methods as widely used by authors for the optimization of various processes. In this study the author showed the application of Genetic algorithm and Evolution algorithm for the optimization of five processes, even when the circular supply chain covers more processes. The literature review of five processes shows that authors more commonly use Genetic algorithms and Evolutionary algorithms in optimization analysis. This proves that these two meta-heuristic methods are suitable for circular supply chain optimization studies.

Further involvement of not fragmented researches is required, which could respond to evolution of supply chain and future zero waste implementation options. These studies would respond to the initiative of European Commission "Creating a Circular Economy - a Europe without Waste" and its implementation.

## References

- Ahmadizar, F., Zeynivand, M., & Arkat, J. (2015). Two-level vehicle routing with cross-docking in a three-echelon supply chain: A genetic algorithm approach. *Applied Mathematical Modelling*, 39(22), 7065-7081. doi: 10.1016/j.apm.2015.03.005
- Ai, T. J., & Kachitvichyanukul, V. (2009). Particle swarm optimization & two solution representations for solving the capacitated vehicle routing problem. *Computers & Industrial Engineering*, 56(1), 380-387. doi: 10.1016/j.cie.2008.06.012
- Bandyopadhyay, S., Saha, S., Maulik, U., & Deb, K. (2008). A simulated annealing-based multiobjective optimization algorithm: AMOSA. *IEEE transactions on evolutionary computation*, 12(3), 269-283. doi: 10.1109/TEVC.2007.900837
- Bjork, K., & Carlsson, C. (2007). The effect of flexible lead times on a paper producer. *International Journal Production Economics*, 107(1), 139-150. doi: 10.1016/j.ijpe.2006.06.021

- Boudhar, H., Dahane, M., & Rezg, N. (2013). Spare part returns in stochastic deteriorating manufacturing system under a condition-based maintenance policy: Simulation-based genetic algorithm approach. *Manufacturing Modelling & Management Control*, 7(1), 1399-1404. doi: 10.3182/20130619-3-RU-3018.00484
- Cai, Y. G., Tang, Y. L., & Yang, Q. J. (2015). An improved genetic algorithm for multi-depot heterogeneous vehicle routing problem with simultaneous pickup & delivery time windows. *Applied Mechanical Material*, 738, 361-365. doi: 10.4028/www.scientific.net/AMM.738-739.361
- Chan, F. T., & Chung, S. H. (2004). A multi-criterion genetic algorithm for order distribution in a demand driven supply chain. *International Journal Computer Integrated Manufacturing*, 17(4), 339-351. doi: 10.1080/09511920310001617022
- Chan, F. T., Chung, S. H., & Wadhwa, S. (2004). A heuristic methodology for order distribution in a demand driven collaborative supply chain. *International Journal Production Research*, 42(1), 1-19. doi: 10.1080/0020754031000103293
- Chang, P., Yao, M., Huang, S., & Chen, C. (2006). A genetic algorithm for solving a fuzzy economic lot-size scheduling problem. *International Journal Production Economy*, 102(2), 265-288. doi: 10.1016/j.ijpe.2005.03.008
- Chen, J. (2014). Logistics network optimization of import crude oil in china based on genetic algorithm. *Advanced Material Research*, 945, 3126-3129. doi: 10.4028/www.scientific.net/AMR.945-949.3126
- Chi, H., Ersoy O. K., Moskowitz, H., & Ward, J. (2007). Modeling & optimizing a vendor managed replenishment system using machine learning & genetic algorithms. *European Journal Operations Research*, 180(1), 174-193. doi: 10.1016/j.ejor.2006.03.040
- Coello, C. C., & Lechuga, M. S. (2002). MOPSO: A proposal for multiple objective particle swarm optimization. *Proceedings of the 2002 Congress on Evolutionary Computation*, 5(2), 1051-1056. doi: 10.1109/CEC.2002.1004388
- Devika, K., Jafarian, A., Hassanzadeh, A., & Khodaverdi, R. (2016). Optimizing of bullwhip effect & net stock amplification in three-echelon supply chains using evolutionary multi-objective metaheuristics. *Annals of Operations Research*, 242(2), 457-487. doi: 10.1007/s10479-013-1517-y
- Diabat, A., Kannan, D., Kaliyan, M., & Svetinovic, D. (2013). An optimization model for product returns using genetic algorithms & artificial immune system. *Resources, Conservation & Recycling*, 74, 156-169. doi: 10.1016/j.resconrec.2012.12.010
- Doolun, I. S., Ponnambalam, S. G., Subramanian, N., & Kanagaraj, G. (2018). Data driven hybrid evolutionary analytical approach for multi objective location allocation decisions: Automotive green supply chain empirical evidence. *Computers & Operations Research*, 98, 265-283. doi: 10.1016/j.cor.2018.01.008
- Dzupire, N. C., & Nkansah-Gyekye, Y. (2014). A multi-stage supply chain network optimization using genetic algorithms. *Mathematical Theory and Modeling*, 4(8), 18-28. Retrieved from arxiv.org/abs/arXiv:1408.0614
- Emdadian, A., Ponnambalam, S. G., & Kanagaraj, G. (2018). An implementation of differential evolution algorithm for a single product & single period multi-echelon supply chain network model. *Journal of Modern Manufacturing Systems & Technology*, 1(1), 1-14. doi: 10.15282/jmmst.v1i1.196

- Erbao, C., & Mingyong, L. (2009). A hybrid differential evolution algorithm to vehicle routing problem with fuzzy demands. *Journal of Computational and Applied Mathematics*, 231(1), 302-310. doi: 10.1016/j.cam.2009.02.015
- Gao, L., Xu, K. L., & Mao, D. X. (2013). Research of sales forecasting model & algorithm in food & beverage enterprise. In E. Qi, J. Shen & R. Dou (Eds.), *The 19th International Conference on Industrial Engineering and Engineering Management*. Berlin: Springer. doi: 10.1007/978-3-642-37270-4\_88
- Ghezavati, V., & Nia, N. S. (2014). Development of an optimization model for product returns using genetic algorithms & simulated annealing. *Soft Computing*, 19(11), 3055-3069. doi: 10.1007/s00500-014-1465-8.
- Govindan, K., Jha, P. C., & Garg, K. (2016). Product recovery optimization in closed-loop supply chain to improve sustainability in manufacturing. *International Journal of Production Research*, 54(5), 1463-1486. doi: 10.1080/00207543.2015.1083625
- Hernandez-Hernandez, H. J., Montoya-Torres, J. R., & Niebles-Atencio, F. (2014). Design of multi-product/multi-period closed-loop reverse logistics network using a genetic algorithm. *2014 IEEE Symposium on Computational Intelligence in Production & Logistics Systems*, 40-47. doi: 10.1109/CIPLS.2014.7007159
- Hifi, M., & M'Hallah, R. (2009). Beam search and non-linear programming tools for the circular packing problem. *International Journal of Mathematics in Operational Research*, 1(4), 476-503. doi: 10.1504/IJMOR.2009.026278
- Jun, T., & Qing, W. (2015). Optimize BP neural network structure on car sales forecasts based on genetic algorithm. *International Industrial Informatics & Computer Engineering Conference*, 75-79. doi: 10.2991/iicec-15.2015.18
- Karakatic, S., & Podgorelec, V. (2015). A survey of genetic algorithms for solving multi depot vehicle routing problem. *Applied Soft Computer*, 27, 519-532. doi: 10.1016/j.asoc.2014.11.005
- Ko, H. J., & Evans, G. W. (2007). A genetic algorithm-based heuristic for the dynamic integrated forward/reverse logistics network for 3PLs. *Computer Operational Research*, 34(2), 346-366. doi: 10.1016/j.cor.2005.03.004
- Ko, H. J., Ko, C. S., & Kim, T. (2006). A hybrid optimization/simulation approach for a distribution network design of 3PLS. *Computer Industrial Engineering*, 50(4), 440-449. doi: 10.1016/j.cie.2005.03.006
- Koh, S. L., Gunasekaran, A., Morris, J., Obayi, R., & Ebrahimi, S. M. (2017). Conceptualizing a circular framework of supply chain resource sustainability. *International Journal of Operations & Production Management*, 37(10), 1520-1540. doi: 10.1108/IJOPM-02-2016-0078
- Krikke, H., van Nunen, J. A., Zuidwijk, R., & Kuik, R. (2005). E-business and circular supply chains: increased business opportunities by IT-based customer oriented return-flow management. In B. Fleischmann & A. Klose (Eds.), *Distribution Logistics*. Berlin: Springer. doi: 10.1007/978-3-642-17020-1\_12
- Kumar, V. N., Kumar, V., Brady, M., Garza-Reyes, J. A., & Simpson, M. (2017). Resolving forward-reverse logistics multi-period model using evolutionary algorithms. *International Journal of Production Economics*, 183, 458-469. doi: 10.1016/j.ijpe.2016.04.026

- Kumar, V. S., Thansekhar, M. R., Saravanan, R., & Amali, S. M. J. (2014). Solving multi-objective vehicle routing problem with time windows by FAGA. *Proceedings Engineering*, 97, 2176-2185. doi: 10.1016/j.proeng.2014.12.461
- Kuo, R. J. (2001). A sales forecasting system based on fuzzy neural network with initial weights generated by genetic algorithm. *European Journal of Operational Research*, 129(3), 496-517. doi: 10.1016/S0377-2217(99)00463-4
- Lam, C. Y., Chan, S. L., Ip, W. H., & Lau, C. W. (2008). Collaborative supply chain network using embedded genetic algorithms. *Industrial Management & Data Systems*, 108(8), 1101-1110. doi: 10.1108/02635570810904631
- Lawrence, J. A., & Pasternack, B. A. (2002). *Applied management science: Modelling, spreadsheet analysis, & communication for decision making*. New Jersey: Wiley
- Lee, L. H., Chew, E. P., Teng, S., & Chen, Y. (2008). Multi-objective simulation-based evolutionary algorithm for an aircraft spare parts allocation problem. *European Journal of Operational Research*, 189(2), 476-491. doi: 10.1016/j.ejor.2007.05.036
- Li, Y., Guo, H., Wang, L., & Fu, J. (2013). A hybrid genetic simulated annealing algorithm for the location-inventory routing problem considering returns under E-supply chain environment. *Science World Journal*, 2013, 125-143. doi: 10.1155/2013/125893
- Li, L. H., Fu, Z., Zhou, H. P., & Hu, Z. D. (2013). Discrete logistics network design model under interval hierarchical OD demand based on interval genetic algorithm. *Journal Central South University*, 20, 2625-2634. doi: 10.1007/s11771-013-1777-3
- Lieckens, K., & Vandaele, N. (2007). Reverse logistics network design with stochastic lead times. *Computer Operational Research*, 34(2), 395-416. doi: 10.1016/j.cor.2005.03.006
- Lieder, M., Asif, F. M., Rashid, A., Mihelič, A., & Kotnik, S. (2017). Towards circular economy implementation in manufacturing systems using a multi-method simulation approach to link design and business strategy. *The International Journal of Advanced Manufacturing Technology*, 93(5-8), 1953-1970. doi: 10.1007/s00170-017-0610-9
- Liu, D. (2014). Network site optimization of reverse logistics for E-commerce based on genetic algorithm. *Neural Computing & Applications*, 25(1), 67-71. doi: 10.1007/s00521-013-1448-1
- Liu, R., Jiang, Z & Geng, N. (2014). A hybrid genetic algorithm for the multi-depot open vehicle routing problem. *OR Spectrum*, 36(2), 401-421. doi: 10.1007/s00291-013-0346-3
- Manavalan, E., & Jayakrishna, K. (2019). An Analysis on Sustainable Supply Chain for Circular Economy. *Procedia Manufacturing*, 33, 477-484. doi: 10.1016/j.promfg.2019.04.059
- Marinakakis, Y., & Marinaki, M. (2013). Combinatorial neighborhood topology particle swarm optimization algorithm for the vehicle routing problem. In M. Middendorf & C. Blum (Eds.), *Evolutionary Computation in Combinatorial Optimization*. Berlin: Springer. doi: 10.1007/978-3-642-37198-1\_12
- Min, H., Ko, H. J., & Ko, C. S. (2006a). A genetic algorithm approach to developing the multi-echelon reverse logistics network for product returns. *Omega*, 34(1), 56-69. doi: 10.1016/j.omega.2004.07.025

- Min, H., Ko, H. J., & Ko, C. S. (2006b). The spatial & temporal consolidation of returned products in a closed-loop supply chain network. *Computers & Industrial Engineering*, 51(2), 309-320. doi: 10.1016/j.cie.2006.02.010
- Mohr, C. M. (2014). *Optimization of warehouse order-picking routes using vehicle routing model & genetic algorithm*. Binghamton: State University of New York.
- Nasir, M. H. A., Genovese, A., Acquaye, A. A., Koh, S. C. L., & Yamoah, F. (2017). Comparing linear and circular supply chains: A case study from the construction industry. *International Journal of Production Economics*, 183, 443-457. doi: 10.1016/j.ijpe.2016.06.008
- Olsen, A. L. (2008). Inventory replenishment with interdependent ordering costs: an evolutionary algorithm solution. *International Journal of Production Economics*, 113(1), 359-369. doi: 10.1016/j.ijpe.2007.09.004
- Pan, S. Y., Du, M. A., Huang, I. T., Liu, I. H., Chang, E. E., & Chiang, P. C. (2015). Strategies on implementation of waste-to-energy (WTE) supply chain for circular economy system: a review. *Journal of Cleaner Production*, 108, 409-421. doi: 10.1016/j.jclepro.2015.06.124
- Pierre, D. M., & Zakaria, N. (2017). Stochastic partially optimized cyclic shift crossover for multi-objective genetic algorithms for the vehicle routing problem with time-windows. *Applied Soft Computing*, 52, 863-876. doi: 10.1016/j.asoc.2016.09.039
- Pishvaei, M. S., Farahani, R. Z., & Dullaert, W. (2010). A memetic algorithm for bi-objective integrated forward/reverse logistics network design. *Computers & Operations Research*, 37(6), 1100-1112. doi: 10.1016/j.cor.2009.09.018
- Pourakbar, M., Farahani, R. Z., & Asgari, N. (2007). A joint economic lot-size model for an integrated supply network using genetic algorithm. *Applied Mathematical Computing*, 189(1), 583-596. doi: 10.1016/j.amc.2006.11.116
- Psychas, I. D., Marinaki, M., & Marinakis, Y. (2015). A parallel multi-start NSGA II algorithm for multiobjective energy reduction vehicle routing problem. In A. Gaspar-Cunha, C. Henggeler Antunes & C. Coello (Eds.), *Evolutionary Multi-Criterion Optimization*. Cham: Springer. doi: 10.1007/978-3-319-15934-8\_23
- Rajendran, V., Devadasan, S. R., & Kannan, S. (2014). Design of a logistics network in an organisation for optimising logistics cost & inventory using RSM & genetic algorithm. *Applied Mechanical Material*, 592, 2601-2607. doi: 10.4028/www.scientific.net/AMM.592-594.2601
- Rogers, D. S., Lambert, D. M., Croxton, K. L. & Garcia-Dastugue, S. J. (2002). The returns management process. *International Journal Logistics Management*, 13(2), 1-18. doi: 10.1108/09574090210806397
- Shankar, B. L., Basavarajappa, S., Chen, J. C., & Kadadevaramath, R. S. (2013). Location & allocation decisions for multi-echelon supply chain network: A multi-objective evolutionary approach. *Expert Systems with Applications*, 40(2), 551-562. doi: 10.1016/j.eswa.2012.07.065
- Shukla, S. K., Tiwari, M. K., Wan, H. D., & Shankar, R. (2010). Optimization of the supply chain network: Simulation, Taguchi, & Psychoclonal algorithm embedded approach. *Computers & Industrial Engineering*, 58(1), 29-39. doi: 10.1016/j.cie.2009.07.016

- Taha, R., Abdallah, K., Sadek, Y., El-Kharbotly, A. & Afia, N. (2014). Design of supply chain networks with supply disruptions using genetic algorithm. *MPRA Paper No. 58062*. Retrieved from [mpra.ub.uni-muenchen.de/58062/](http://mpra.ub.uni-muenchen.de/58062/)
- Tan, K. C., Cheong, C. Y., & Goh, C. K. (2007). Solving multiobjective vehicle routing problem with stochastic demand via evolutionary computation. *European Journal of Operational Research*, 177(2), 813-839. doi: 10.1016/j.ejor.2005.12.029
- Tan, K. C., Chew, Y. H., & Lee, L. H. (2006). A hybrid multiobjective evolutionary algorithm for solving vehicle routing problem with time windows. *Computational Optimization & Applications*, 34(1), 115. doi: 10.1007/s10589-005-3070-3
- Tiwari, A., Chang, P. C., Tiwari, M. K., & Kandhway, R. (2016). A Hybrid Territory Defined evolutionary algorithm approach for closed loop green supply chain network design. *Computers & Industrial Engineering*, 99, 432-447. doi: 10.1016/j.cie.2016.05.018
- Trappey, A. J., Trappey, C. V., & Wu, C. R. (2010). Genetic algorithm dynamic performance evaluation for RFID reverse logistic management. *Expert Systems with Applications*, 37(11), 7329-7335. doi: 10.1016/j.eswa.2010.04.026
- Tsolakis, N., & Srari, J. S. (2017). Inventory planning and control in 'green' pharmacies supply chains-A System Dynamics modelling perspective. *Computer Aided Chemical Engineering*, 40, 1285-1290. doi: 10.1016/B978-0-444-63965-3.50216-6
- Tsou, C. S. (2009). Evolutionary Pareto optimizers for continuous review stochastic inventory systems. *European Journal of Operational Research*, 195(2), 364-371. doi: 10.1016/j.ejor.2008.02.039
- Vergara, F. E., Khouja, M., & Michalewicz, Z. (2002). An evolutionary algorithm for optimizing material flow in supply chains. *Computers & Industrial Engineering*, 43(3), 407-421. doi: 10.1016/S0360-8352(02)00055-4
- Wang, Y., Li, B., & Weise, T. (2010). Estimation of distribution & differential evolution cooperation for large scale economic load dispatch optimization of power systems. *Information Sciences*, 180(12), 2405-2420. doi: 10.1016/j.ins.2010.02.015
- Wang, L., He, J., Wu, D., & Zeng, Y. R. (2012). A novel differential evolution algorithm for joint replenishment problem under interdependence & its application. *International Journal of Production Economics*, 135(1), 190-198. doi: 10.1016/j.ijpe.2011.06.015
- Wang, L., Zeng, Y., & Chen, T. (2015). Back propagation neural network with adaptive differential evolution algorithm for time series forecasting. *Expert Systems with Applications*, 42(2), 855-863. doi: 10.1016/j.eswa.2014.08.018
- Yu, X., & Leng, Z. (2012). Study of Optimizing the Agriculture Circular Economy Operation Models by DEA Method. *Proceedings of the 2012 Second International Conference on Electric Information and Control Engineering*, 4, 604-607. doi: 10.5555/2452574.2454343
- Zhang, J., & Li, J. (2014). A hybrid genetic algorithm to the vehicle routing problem with fuzzy cost coefficients. *2014 IEEE 11th International Conference on Fuzzy Systems & Knowledge Discovery*, 147-152. doi: 10.1109/FSKD.2014.6980823
- Zhang, S., & Qinghe, H. (2014). Application of GA optimizing neural network to coal sales forecasts. *Proceedings of the 2nd International Conference on Information, Electronics & Computer*. doi: 10.2991/icieac-14.2014.32

Zhou, G., & Min, H. (2011). Designing a closed-loop supply chain with stochastic product returns: A Genetic Algorithm approach. *International Journal Logistics Systems Management*, 9(4), 397-418. doi: 10.1504/IJLSM.2011.041863

### **Contact information**

#### **Aurelija Burinskiene**

Vilnius Gediminas Technical University, Faculty of Business Management

Sauletekio al. 11, 10223 Vilnius, Lithuania

E-mail: aurelija.burinskiene@vgtu.lt

ORCID: 0000-0002-4369-8870

doi: 10.7441/dokbat.2019.017



# DETERMINANTS OF FINANCIAL CAPABILITY: EVIDENCE FROM A TRANSITION COUNTRY

*Gentjan Çera, Bekim Poleshi, Khurram Ajaz Khan, Arjan Shumeli, Oksana Kojku*

## Abstract

Among scholars, academicians and policymakers there is a constant concern on how to improve financial literacy and capability of individuals. In this regard, this study seeks to investigate the effect of financial literacy along with demographic factors on individuals' financial capability. This research is administrated on an individual-level data collection through a survey. This paper uses hierarchical multiple regression with two steps in a dataset of 200 respondents from a transition country, Albania. Results demonstrated that financial capability is affected by financial knowledge and financial behaviour. In addition, individuals that were single, unemployed and young negatively influenced financial capabilities. However, having higher incomes positively impacted financial capability. These findings are consistent with the literature in the field of financial literacy. Financial attitude and gender did not show any significant effect on financial capability. This paper contributes to enriching the literature of the field by offering evidence on how financial literacy and demographic factors drive individuals' financial capability. In addition, this current study provides useful insights for academicians, educational institutions managers, and public-policy advocates responsible for designing curricula and strategies to increase the level of individuals' financial capability.

**Keywords:** *financial capability, financial attitude, financial knowledge, financial behaviour, hierarchical linear regression, Albania*

## 1 INTRODUCTION

We are all witnesses of the rapid development that the global economy is facing from the last decades. Banking products and financial markets are becoming more and more complex. It is almost impossible to be indifferent to this situation because, in one way or another, we all face certain financial situations in our daily lives. In that sense, it is very important for economic agents to be on the same line of development as the economy and its branches, especially for individuals. In today's economic reality there are some problems that need to be resolved as soon as possible, problems that are common in almost all the countries.

Albania is a transition country and of course, its economic agents are heavily affected by these kinds of problems – low levels of financial inclusion and access to financial products, poor planning and decision-making related to savings or investments, bad management of incomes and spending, etc. It is believed that most of these kinds of problems are a derivative of low financial capability and its causative factors. This situation has big consequences on individuals and since an individual is considered to be the basic cell of a society, this will negatively impact the economy as a whole. Based on what most of the researchers conclude, nowadays the governments in different countries pursue policies geared to increasing financial literacy and financial capability of individuals - providing a favourable environment for people to understand the complexities of their finance, take optimal financial decisions and setting other financial goals wisely. The promotion of financial capability at individuals is being always more significant in recent years (Loke, Choi & Libby, 2015). The policy-makers consider it as a challenge that needs to be won and recently they are making strong calls to increase individuals'

financial capability (Batty, Collins & Odders-White, 2015). In a transition country like Albania, it is essential for economic agents to have the appropriate level of financial literacy and financial capability to be more efficient in economic decision-making and to have more access to financial products. To do so, people must develop a certain level of financial attitude, financial knowledge and financial behaviour (Hira, 2012).

This paper aims to indicate the factors that drive individuals' financial capability and to examine the relationship that exists between them. The study provides a statistical analysis based on a survey where 200 random individuals responded to some particular statements designed to measure the level of financial capability, knowledge, attitude, and behaviour. The local literature on this issue is not very rich, so this topic may be something of interest to researchers, academicians, policy-makers or other people related to this field of study as it aims to shed light on an issue about which there exist clear information gaps.

In this regard, several research questions can be raised and this paper aims to provide answers: does the level of financial attitude, knowledge, and behaviour of individuals affect their financial capability? Regarding demographic factors, how do they relate to individuals' financial capability? How does this problem stand in the researchers' point of view? What can be done to improve the overall level of financial capability at individuals?

## **2 LITERATURE REVIEW**

There is a large number of researchers who are focused on the concept of financial capability, its importance to the individuals and the main influencing factors. In fact, the literature of the field suggests that there is a variety of factors that can affect the level of individuals' financial capability. Different authors emphasize the effect of financial literacy on individuals' financial capability, as well as the effect of some demographic factors.

In theory, financial literacy is heavily linked with financial capability, but do we understand financial literacy? This is a concept that doesn't have a single definition. As Vieira, Caroline and Potrich (2019) explained, the term 'financial literacy' has often been used as a synonym for financial education or financial knowledge, but in fact it is not the same thing. Huston (2010) gives two dimensions for financial literacy: understanding, which refers to the level of personal knowledge for financial terms and concepts, and use, which refers to the application or the management of these knowledge. Financial experts often use this term to describe a group of knowledge and skills which are necessary to effectively manage money (Remund, 2010). Atkinson and Messy (2012) agreed on a conceptual framework related to the concept of financial literacy – they see it as a function of financial knowledge, financial attitude, and financial behaviour. This is a widely used definition and, the same is the reason for using it in the current study.

What about the financial capability? As a matter of fact, in theory, financial capability is considered as a relatively new concept emerged in the recent years. Jian, Chen and Chen (2014) define financial capability as the application of financial knowledge and as they explain, individuals' financial capability favours such financial behaviours that influence the enhancement of overall financial well-being. Bumcrot et al. (2013) state that financial capability is measured in terms of how well people make ends meet, plan ahead, choose and manage financial products, and possess the skills and knowledge to make financial decisions. Financial capability is introduced to broaden the concept of financial literacy (Kempson, Perotti & Scott, 2013). Researchers conceptualized financial capability not only as knowledge, but they say that the term 'financial capability' includes the individuals' ability to use this knowledge in their daily lives.

In the light of the literature review, the following variables are taken into consideration financial literacy (attitude, knowledge, and behaviour) and selected demographic factors (age, gender, marital status, occupation and the level of income). The above discussion supports to examine the relationship between financial capability and selected financial and demographic factors. Hence, the objective of the study is to develop a conceptual framework, set the hypothesis and support or reject them through the statistical evidence.

Referring to the theoretical model considered in this paper, financial attitude is one of the three-building pillars of financial literacy (along with financial knowledge and financial behaviour). Rai, Dua and Yadav (2019) have defined financial attitude as the tendency of individuals towards financial matters or as a way of approaching financial issues. Other researchers of the field define financial attitude as the reaction of the individuals towards money-related issues like investment, saving, setting financial goals, etc. There are also some researchers that have a different point of view for the definition of individuals' financial attitudes. For example, Woodyard and Robb (2012) conceptualized the financial attitude as a subcategory of financial perception. They suggested that financial attitude includes subjective financial knowledge that is related to social factors, financial well-being and the importance of setting financial goals for the future.

The theory also discussed whether financial attitude affects the financial capability of individuals. Shim, Serido, Bosch and Tang (2013) reinforce this approach in their study as they approve this relationship arguing that financial attitude can influence financial capability. Based on the findings of Batty, Collins and Odders-White (2015), the study indicates that improved financial attitudes and behaviours are known to boost the financial capability of individuals, a fact that supports a possible positive relationship between financial attitude and financial capability. Although, an indirect relationship between these concepts were presented by some researchers. Referring to Potrich, Vieira and Mendes-Da-Silva (2016), financial attitude precedes financial behaviour and referring to Homer and Kahle (1988), financial attitude influences financial behaviour. The researchers argue that there is a direct and positive relationship between financial attitude and financial behaviour. Since the literature of the field suggests that financial behaviour influences financial capability, we can say that financial attitude may impact financial capability. In fact, a direct relationship between financial attitude and financial capability is yet to be proven, hence this study will try to examine the relationship. Regarding the above discussion, a hypothesis can be framed as:

**Hypothesis 1 (H1):** Financial attitude positively affects financial capability

In theory, there are several definitions related to individuals' financial knowledge. In simple words, knowledge can be defined as what we know, it can also be defined as a group of knowledge limited to a certain field, in this case, the economic field – but these are general definitions. Faulcon Bowen (2002) defines financial knowledge as an understanding of key financial terms and concepts. Referred to this author, the concept of financial knowledge of individuals includes knowledge related to banking and savings, insurance, use of credit card, taxes and investing. While Rothwell, Khan and Cherney (2016) state financial knowledge as an individual's understanding of microeconomics, macroeconomics and personal finance. Also, these authors consider financial knowledge to be an internal capability of individuals. On the other hand, Delavande, Rohwedder and Willis (2009) consider financial knowledge to be a particular type of human capital related to the ability to manage incomes, expenditures and savings in a safe way.

Financial knowledge as a concept has been strongly linked to financial capability by the researchers of the field. There are a lot of researchers who have done numerous researches related to this issue as it is considered a very important one. As we mentioned above, financial

knowledge means learning new concepts related to the field of economy or finance. But learning new financial concepts, based on Batty, Collins and Odders-White (2015) findings, affects individuals' financial capability levels. These researchers say in their study that the process of increasing the level of overall financial knowledge is heavily associated with improved financial attitudes and financial behaviours. Since financial knowledge, financial attitude and financial behaviour are considered as building pillars of financial literacy and financial literacy itself is proven to have a positive impact on individuals' financial capability, it's fair to say that higher levels of financial knowledge derive higher levels of financial capability. Also, we can conclude that by increasing our financial knowledge, we create a good base of financial capability in the long run. Based on the above discussion, the following hypothesis is formulated:

**Hypothesis 2 (H2):** An increased level of financial knowledge results in an increased level of financial capability.

Behavioural finance is a relatively new field of economics. The way individuals behave concerning financial issues has taken increasing attention from the researchers in the last decade. Financial behaviour is a complex term that includes all the financial activities done by economic agents (Mudzingiri, Muteba Mwamba & Keyser, 2018). Similarly, Bhushan (2014) also defined financial behaviour as any behaviour related to financial decision-making and money management. Rai et al. (2019) stated in their study such financial behaviours like financial planning, saving, budgeting, investing, debt payment, etc.

The number of studies has legitimated a significant relationship between financial behaviour and the financial capability of individuals. In theory, higher levels of financial behaviours are associated with higher financial capability. Actually, individuals' financial behaviour is considered as a very important area to be studied from the researchers' point of view in the recent years. For example, in their study, Potocki and Cierpień-Wolan (2018) consider financial behaviour as an essential factor in determining the individuals' financial capability. In the same line are Mitchell and Lusardi (2011), whose findings show that individuals' financial capability can be measured through financial behaviour. Recent studies consider financial behaviour to be one of the most important factors affecting financial capability. Jian et al. (2014) are in the same logic line as they highlight the fact that financial behaviour has a big impact on the financial capability of individuals. Thus:

**Hypothesis 3 (H3):** There is a positive relationship between financial behaviour and financial capability.

The demographic factors are seen with interest from researchers about how they are related to financial capability. In fact, several variables have been shown as significant predictors of financial literacy and financial capability. In literature, there are mentioned demographic factors like age, ethnicity, gender, education level, income level, marital status, occupation, region, wealth, residential area, housing, the number of children, health, etc. In this paper we are taking into consideration age, gender, marital status, education and occupation and we will try to examine the relationship that they have with financial capability.

Based on a study that Lusardi, Mitchell and Curto (2010) have made, there are significant differences in financial literacy level based on demographic variables such as gender, age or income. Since financial literacy was told to have a big impact on financial capability, logically we assume that these demographic factors have a similar effect on financial capability too. Regarding incomes, Atkinson et al. (2007) in their paper show that consumers with different incomes have different concepts for financial capability, concluding that those with higher incomes tend to have higher levels of financial capability and those with lower incomes tend to be financially incapable. Regarding this issue, Taylor (2009) also observed the impact of some

demographic factors on financial capability and concluded that those who are young (aged less than 35), single and/or unemployed, show lower levels of financial capability. Bumcrot et al. (2013) are in the same line as they find in their study that the young and those with low education are very likely to have low financial capability. Therefore:

**Hypothesis 4 (H4):** Demographic factors (income, H4a; being not single, H4b; being male, H4c, employed, H4d) positively influence individuals' financial capability.

The above discussion is based on what the researchers of the field have concluded. Considering their findings, the current study raised four different hypothesis that may be accepted or rejected on the basis of the framed conceptual framework (see Figure 1).

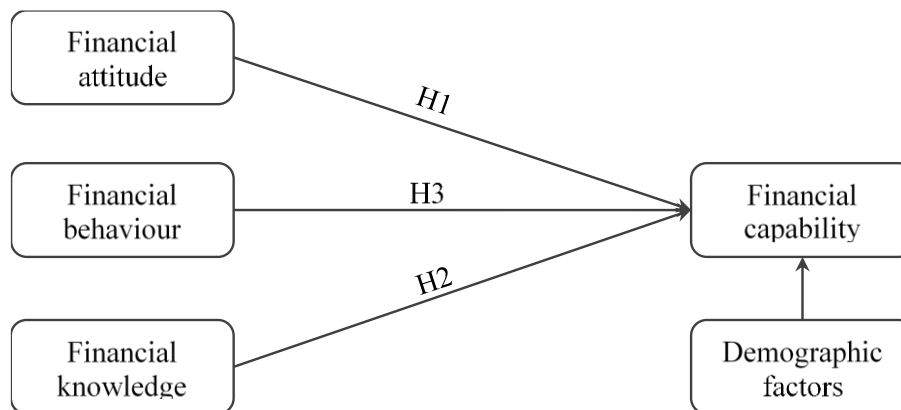

Fig. 1 – Theoretical model. Source: own research

### 3 METHOD AND PROCEDURES

#### 3.1 Variable measurement

As with previous researches, financial attitudes, knowledge, behaviour and capability were measured as self-reported scale (Allgood & Walstad, 2016; Gutter, Copur, & Garrison, 2016; Shih & Ke, 2014). Several indicators per each factor were found in the literature. Each indicator was formulated as a statement with five possible answers ([1] Strongly disagree, [2] Disagree, [3] Neither disagree, nor agree, [4] Agree, [5] strongly agree), making it a Likert type scale. Our variables were created as the mean of these indicators.

The dependent variable in the current research is financial capability. It was measured by five indicators, which are: I can arrange at least 1000\$ (AL: 70 000 ALL) in an unexpected needs arose within the next month; I have enough funds to survive for three months without regular earnings; I often use electronic payment mode for paying bills through (credit card, debit card, online banking, mobile banking etc.); I have too much debt right now; I am good at dealing with day-to-day financial matters, such as checking accounts, credit and debit cards and tracking expenses. This scale was proposed by a prior study (Robb & Woodyard, 2011) and the National Financial Capability Study in 2012 covering the United States of America.

Influenced by several prior scholars and experts in the field of financial literacy (Atkinson & Messy, 2011, 2012; Garber & Koyama, 2017; Potrich, Vieira & Kirch, 2015), financial attitude was measured by eight statements, which are: It is important to set goals for the future; I tend to live for today and let tomorrow take care of itself; After making a decision about money, I tend to worry too much about my decision; I find it more satisfying to spend money than save it for the long term; Money is there to be spent; I pay my bills on time; I keep a close personal watch on my financial affairs; I am prepared to risk some of my own money when saving or making an investment.

There are two types of measuring financial knowledge: objectively and subjectively (Serido, Shim & Tang, 2013). In this paper, the subjective type was used. Hence, financial knowledge was measured by eight items: Investing in different assets reduce risk; It is less likely that you will lose all of your money if you save them in more than one place; I understand the cost of buying on credit; I am pretty good at calculation like profit and loss, percentage etc.; An investment with a high return is likely to be high risky; High inflation mean that the cost of living is increasing rapidly; If price goes up rapidly, the money people have in saving accounts could lose much of its value; Electronic fund transfers are riskless (credit card, debit card, online banking etc.). This scale was developed as a combination of several prior studies (Çera & Tuzi, 2019; Faulcon Bowen, 2002; Lusardi & Mitchell, 2007; Robb & Woodyard, 2011).

In accordance with prior researches (Joo & Grable, 2004; Potrich et al., 2016), six indicators were used to measure financial behaviour: I take notes and control my personal expenses (e.g., expense and revenue spreadsheet); I establish financial targets for the long term that influence the managing of my expenses; I follow a weekly or monthly plan for expenses; I compare prices when buying something; I analyse my financial situation before a big purchase; I have plans to achieve my financial goals (retirements, savings, investments etc.).

Table 1 informs about the descriptive statistics of our composed variables: financial attitude, financial knowledge, financial behaviour, and financial capability. As it can be seen, the mean of financial attitude was 3.477, and its values ranges from 1 to the maximum possible number of Likert scale (5). This ranges of values was reported even in case of financial behaviour with a mean of 3.743. Financial knowledge reflected a mean of 3.494, minimum of 1.250 and a maximum of 4.875. The minimum, mean and maximum values of financial capability were 1, 2.996 and 4.750.

Tab. 1 – Descriptive statistics for the composed variables. Source: own research

Variable	Code	Number of items	Min	Mean	Max
Financial attitude	fin_att	8	1.000	3.477	5.000
Financial knowledge	fin_knw	8	1.250	3.494	4.875
Financial behaviour	fin_beh	6	1.000	3.743	5.000
Financial capability	fin_cap	5	1.000	2.996	4.750

### 3.2 Method

Hierarchical multiple regression with two steps was performed in way to test the effect of financial attitude, knowledge, and behaviour along with demographic variables on financial capability. This method was used because it tests the significance of inclusion into the analysis sets of variables in the forms of blocks. In the current research, the first block of variables consists of demographic ones such as age, gender, unemployed, material status (single) and income. In the second step (block of variables), financial literacy variables were included. By doing so, this type of regression can inform what is the contribution of each set of variables to the explanation of the dependent variable (Pallant, 2016). The dependent variable was financial capability. Its mathematical form can be written:

$$\begin{aligned}
 \text{fin\_cap} = & \overbrace{\beta_0 + \beta_1 \text{age} + \beta_2 \text{male} + \beta_3 \text{singel} + \beta_4 \text{unemployed} + \beta_5 \text{income}}^{\text{first step}} \\
 & + \underbrace{\beta_6 \text{fin\_att} + \beta_7 \text{fin\_knw} + \beta_8 \text{fin\_beh}}_{\text{second step}}
 \end{aligned}
 \tag{1}$$

All analyses were done using computer statistical software SPSS version 23 (Meyers, Gamst & Guarion, 2013).

### 3.3 Sample

To test the proposed hypotheses in the theoretical model (see Figure 1), initially a questionnaire in the Albanian language was developed based on literature review. The questionnaire contained two main sections: indicators for four constructs of our theoretical model, along with the demographic characteristics.

The target population consists of adult individuals aged from 18 to 70 living in Albania. The stratified sample technique was applied. Thus, the sample size was designed based on the distribution of the Albanian population in terms of age, gender and region. The collection phase of the data took place on June 2019. The subjects were approached physically, so the questionnaire was filled in face-to-face. About 30 respondents were removed from the sample because it was noticed the same answer for several statements when logically it should not be so. The final sample consists of 200 valid respondents.

Table 2 illustrates the sample profile in terms of demographic variables. The majority of respondents were females (59%), single (55.5%) and employed (66.5%). The average age respondents were 29.6 years old (the youngest was 18 years old, whereas the oldest was 70 years old). The sample distributions according to income levels were: from the lowest category were 25%, from the second level were 42.5% and the rest were from the fourth and highest levels of income.

Tab. 2 – Sample profile. Source: own research

Category	Sub-category	N	Percent
Gender	Female	118	59
	Male	82	41
Material status	Single	111	55.5
	Others	89	44.5
Employment	Unemployed	67	33.5
	Employed	133	66.5
Income	Less than 26 000 ALL	50	25
	26 000 – 50 000 ALL	85	42.5
	50 000 – 100 000 ALL	45	22.5
	More than 100 000 ALL	20	10
Total valid		200	100

Note: Exchange rate on 5<sup>th</sup> October 2019: 1 USD = 111.62 ALL, 1 EUR = 122.56 ALL.

## 4 FINDINGS AND DISCUSSION

### 4.1 Empirical findings

As mentioned in the previous section, hierarchical linear regression was applied to test the proposed hypotheses. Tables 3 and 4 report basics statistics of the models and analysis of variance. Model 1 includes five independent variables (income, male, single, unemployed, and age), which explained 26.9% of the financial capability's variance,  $F(5, 194) = 15.623$ ,  $p < .001$ . After entry of the new variables (fin\_knw, fin\_att, and fin\_beh) at the second step of the model, the total variance explained by the model as a whole was 41.2%,  $F(8, 191) = 16.715$ ,  $p < .001$ . The three added variables explained an additional 12.5% of the variance in financial capability, after controlling for demographic variables,  $R$  squared change = .125,  $F$  change (3, 191) = 13.502,  $p < .001$ . This considerable increase in the explained variance in the dependent variable demonstrates the importance of financial literacy in explaining financial capability.

Tab. 3 – Model summary. Source: own research

Model	R	R Square	Adjusted R Square	Std. Error of the Estimate	Change Statistics				
					R Square Change	F Change	df1	df2	Sig. F Change
1	.536 <sup>a</sup>	.287	.269	.66389	.287	15.623	5	194	.000
2	.642 <sup>b</sup>	.412	.387	.60774	.125	13.502	3	191	.000

a. Predictors: Constant, income, male, single, unemployed, age

b. Predictors: Constant, income, male, single, unemployed, age, fin\_knw, fin\_att, fin\_beh

Tab. 4 – Analysis of variance. Source: own research

Model		Sum of Squares	df	Mean Square	F	Sig.
1	Regression	34.429	5	6.886	15.623	.000 <sup>b</sup>
	Residual	85.506	194	.441		
	Total	119.935	199			
2	Regression	49.389	8	6.174	16.715	.000 <sup>c</sup>
	Residual	70.545	191	.369		
	Total	119.935	199			

Note: Dependent variable: fin\_cap; b. Predictors: constant, income, male, single, unemployed, age; c. Predictors: constant, income, male, single, unemployed, age, fin\_knw, fin\_att, fin\_beh

Table 5 summarises the results of the effect of each variable on financial capability. Hence, for the first block of variables, it was found that three out of five variables were statistically significant in predicting individuals' financial capability. The significant effects originated from age, being unemployed, and level of income. As the age of individuals increased, the financial capability level of individuals diminished,  $\beta = -.185$ ,  $t = 2.140$ ,  $p < .05$ . Being unemployed reduced the level of an individual's financial capability,  $\beta = -.240$ ,  $t = 3.197$ ,  $p < .01$ . On the other hand, as the individuals' income increased, the higher was the level of financial capability,  $\beta = .370$ ,  $t = 5.257$ ,  $p < .001$ . The effect of material status on financial capability was found to be at the edge of acceptance as an important variable,  $\beta = -.141$ ,  $t = 1.648$ ,  $p = .101$ . It was believed that the inclusion of other variables could transform this variable into a significant one. Gender was not an important predictor of the individual's financial capability,  $\beta = -.023$ ,  $t = .355$ ,  $p > .10$ .

In the second sequence of the regression were added new variables covering financial literacy (financial attitude, financial knowledge, and financial behaviour). Regression revealed that financial knowledge positively influenced individuals' financial capability,  $\beta = .165$ ,  $t = 2.563$ ,  $p = .011$ , supporting H2. A positive relationship was reported even between financial behaviour and financial capability,  $\beta = .282$ ,  $t = 4.221$ ,  $p < .001$ , supporting H3. The data failed to support the positive relationship between financial attitude and financial capability,  $\beta = -.034$ ,  $t = .547$ ,  $p > .10$ , rejecting H1.

Along with the added variables into the second step of the regression, the effect of demographic factors on financial capability was assessed. As it was expected from the first sequence of the regression, being single statistically influenced individuals' financial capability,  $\beta = -.137$ ,  $t = 1.731$ ,  $p < .10$ . So, those that were single reflected lower values in financial capability, as compared to the other material statuses. Referring to the other demographic factors, almost similar results were noticed as in the first step of the model. Hence, financial capability was negatively influenced by (besides being single) being unemployed ( $\beta = -.241$ ,  $t = 3.469$ ,  $p < .001$ ) when compared to those employed, and young individuals ( $\beta = -.231$ ,  $t = 2.859$ ,  $p < .01$ ). The level of income positively impacted financial capability,  $\beta = .279$ ,  $t = 4.226$ ,  $p < .001$ . Thus, excluding material status, demographic variables affect financial capability, supporting H4.



Tab. 5 – Results of the regression. Source: own research

Model		Unstandardized coefficients		Standardized coefficients	t	Sig.	Collinearity statistics	
		B	Std. Error	Beta			Tolerance	VIF
1	constant	2.968	.276		10.739	.000		
	unemployed	-.393	.123	-.240	-3.197	.002	.653	1.531
	single	-.220	.133	-.141	-1.648	.101	.501	1.996
	male	-.036	.101	-.023	-.355	.723	.893	1.119
	age	-.013	.006	-.185	-2.140	.034	.493	2.028
	income	.312	.059	.370	5.257	.000	.742	1.347
2	constant	1.392	.433		3.218	.002		
	unemployed	-.395	.114	-.241	-3.469	.001	.638	1.568
	single	-.214	.123	-.137	-1.731	.085	.491	2.037
	male	-.012	.093	-.008	-.132	.895	.873	1.145
	age	-.016	.006	-.231	-2.859	.005	.470	2.127
	income	.235	.056	.279	4.226	.000	.706	1.416
	fin_att	-.048	.087	-.034	-.547	.585	.796	1.256
	fin_knw	.225	.088	.165	2.563	.011	.741	1.350
	fin_beh	.322	.076	.282	4.221	.000	.691	1.448

Note: Dependent variable: fin\_cap; unemployed (1=yes, 0=no); single (1=single, 0=otherwise), male (1=male, 0=otherwise); age (scale variable), income (categorical variable).

Concerning the assumption dealing with multicollinearity, the hierarchical multiple regression evaluates two statistics: tolerance and variance inflation factor (VIF). Sufficient evidence was found supporting its absence in both steps of the model since among all VIF values, was not found any value above the conservative threshold (value of 3) (see Table 5). Alternatively, the tolerance values for each variable were reported higher than the minimum criteria of .10 (Pallant, 2016). These findings emphasized that the multicollinearity assumption was not violated.

## 4.2 Discussion

The current paper has shown insight results regarding the links between components of financial literacy (financial knowledge, attitude, and behaviour) and individuals' financial capability. The data revealed that financial capability was significantly related to financial knowledge and behaviour. Moreover, demographic factors were found to be important in predicting individuals' financial capability.

Financial capability can be predicted by financial knowledge. Indeed, results showed that the relationship between them was positive and significant. This means that as the level of financial knowledge increases, the higher the individual's financial capability. Prior studies have demonstrated similar results (Chowa, Ansong & Despard, 2014; Potocki & Cierpień-Wolan, 2019; Rothwell, Khan & Cherney, 2016; Serido et al., 2013; Xiao, Chen & Chen, 2014). The current paper found evidence supporting the positive influence of financial behaviour on individuals' financial capability. Similar to the case of financial knowledge, an increase in financial behaviour leads to the improvement of financial capability. This finding goes in line with previous research conducted in this field (Potocki & Cierpień-Wolan, 2019; Serido et al., 2013; Vlaev & Elliott, 2017). Demographic factors significantly influence on individuals' financial capability. Hence, being single, unemployed and young negatively affect financial capability. These findings are consistent with prior research (Friedline & West, 2016; Potocki & Cierpień-Wolan, 2019; Taylor, 2009; Xiao, Chen & Sun, 2015). On the other hand, having high income could lead to better levels of financial capability, which is consistent with prior studies (Atkinson et al., 2007; Jian et al., 2014; Xiao & O'Neill, 2016).

## 5 CONCLUSION

This paper was aimed to find the determinants of the financial capability of adult individuals living in a transition country. A burgeoning interest is growing on financial literacy and capability, focusing on their determinants and consequences (Feng, Lu, Song, & Ma, 2019; Lusardi & Mitchell, 2014; Luukkanen & Uusitalo, 2019; Potocki & Cierpień-Wolan, 2019). In this context, the current study offers evidence regarding important factors that influence individuals' financial capability.

This study provides useful insights which in turn can be divided into theoretical and academic contributions. The modification of the conceptual framework is one of the contributions. Even though financial capability was expected to be determined by financial literacy (financial attitude, knowledge, and behaviour) along with demographic variables, the financial attitude was found to be an insignificant factor. This finding contradicts previous studies (Luukkanen & Uusitalo, 2019; Sherraden & Ansong, 2016). Due to this fact, additional efforts should be made to distinguish the meaning of financial attitude and financial capability. Albanians are introduced with financial means relatively recently. Albania is a post-communist country yet under transition from the previous system to a free-market one. In addition to this, gender did not influence financial capability, while prior research has demonstrated its importance in this regard (Çera & Tuzi, 2019; Chen & Volpe, 2002; Feng et al., 2019; Potrich, Vieira & Kirch, 2018). On the other hand, the paper's findings are useful for policymakers and managers of educational institutions in Albania. They are strongly encouraged to adopt or design new curricula, policies, and strategies in a way to increase the level of financial capability. Taking these actions can be motivated by the results of this study, which stressed out that the level of financial capability can be improved by increasing the level of financial knowledge and behaviour. Since, compared to old individuals, young adults reflected the lower level of financial capability, curricula in higher education institutions should pay more attention to financial literacy, especially to the components related to financial knowledge and behaviour.

The results of this study are useful for designing policies with the main purpose of enhancing the knowledge and skills of young people living in Tirana, on the management of personal finances and to recommend a mechanism that should be used to ensure a satisfactory level of financial literacy. Study results are useful to policymakers since differences in financial literacy in terms of gender among young people were identified. Therefore, policymakers should pay attention to differences in gender when they design the financial education policy.

Even though the aim of the paper was fulfilled, yet there are some limitations. In terms of generalization of its finding, although the statistical method revealed significant relationships in the context of Albania, yet again they cannot transfer to the other countries. This limitation can be overcome with further research by replicating it to the other countries. From the methodological point of view, more rigorous methods can be used to test the proposed hypotheses in this study. Further research is encouraged to apply other methods such as nonparametric ones or structural equation modelling.

### **Acknowledgment**

This paper was supported by the Internal Grant Agency of Faculty of Management and Economics, Tomas Bata University, no. IGA/FaME/2019/002: The role of institutional environment in fostering entrepreneurship.

## References

- Allgood, S., & Walstad, W. B. (2016). The effects of perceived and actual financial literacy on financial behaviors. *Economic Inquiry*, 54(1), 675-697. doi: 10.1111/ecin.12255
- Atkinson, A., McKay, S., Collard, S., & Kempson, E. (2007). Levels of Financial Capability in the UK. *Public Money and Management*, 27(1), 29-36. doi: 10.1111/j.1467-9302.2007.00552.x
- Atkinson, A., & Messy, F. A. (2011). *Assessing financial literacy in 12 countries: an OECD/INFE international pilot exercise*. Paris, France: OECD.
- Atkinson, A., & Messy, F. A. (2012). *Measuring Financial Literacy: Results of the OECD / International Network on Financial Education (INFE) Pilot Study*. Paris, France: OECD
- Batty, M., Collins, J. M., & Odders-White, E. (2015). Experimental evidence on the effects of financial education on elementary school students' knowledge, behavior, and attitudes. *Journal of Consumer Affairs*, 49(1), 69-96. doi: 10.1111/joca.12058
- Bhushan, P., & Medury, Y. (2014). An Empirical Analysis of Inter Linkages Between Financial Attitudes, Financial Behaviour and Financial Knowledge of Salaried Individuals. *Indian Journal of Commerce & Management Studies*, 5(3), 58-64. Retrieved from <https://search-proquest-com.proxy.k.utb.cz/docview/1561350615?accountid=15518>
- Bumcrot, C. B., Lin, J., & Lusardi, A. (2011). The Geography of Financial Literacy. *Advancing Education in Quantitative Literacy*, 6(2), 1-26. doi: 10.5038/1936-4660.6.2.2
- Çera, G., & Tuzi, B. (2019). Does gender matter in financial literacy? A case study of young people in Tirana. *Scientific Papers of the University of Pardubice, Series D*, 45(1), 5-16. Retrieved from <https://dk.upce.cz/handle/10195/72241>
- Chen, H., & Volpe, R. P. (2002). Gender differences in personal financial literacy among college students. *Financial Services Review*, 11, 289-307. doi: 10.5897/AJBM10.1267
- Chowa, G., Ansong, D., & Despard, M. R. (2014). Financial Capabilities: Multilevel Modeling of the Impact of Internal and External Capabilities of Rural Households. *Social Work Research*, 38(1), 19-35. doi: 10.1093/swr/svu002
- Delavande, A., Rohwedder, S., & Willis, R. J. (2009). Preparation for Retirement, Financial Literacy and Cognitive Resources. *Michigan Retirement Research Center Research Paper*, No. 2008-190, 1-45. doi: 10.2139/ssrn.1337655
- Falcon Bowen, C. (2002). Financial Knowledge Of Teens And Their Parents. *Financial Counseling and Planning*, 13(2), 93-101. Retrieved from <https://search-proquest-com.proxy.k.utb.cz/docview/1355863175?accountid=15518>
- Feng, X., Lu, B., Song, X., & Ma, S. (2019). Financial literacy and household finances: A Bayesian two-part latent variable modeling approach. *Journal of Empirical Finance*, 51, 119-137. doi: 10.1016/j.jempfin.2019.02.002
- Friedline, T., & West, S. (2016). Financial Education is not Enough: Millennials May Need Financial Capability to Demonstrate Healthier Financial Behaviors. *Journal of Family and Economic Issues*, 37(4), 649-671. doi: 10.1007/s10834-015-9475-y
- Garber, G., & Koyama, S. M. (2017). Policy-effective Financial Knowledge and Attitude Factors. *Central Bank of Brazil Working Papers*, No. 430, 1-47. Retrieved from <https://www.bcb.gov.br/pec/wps/ingl/wps430.pdf>
- Gutter, M. S., Copur, Z., & Garrison, S. (2016). Do the financial behaviours of college students vary by their state's financial education policies? In C. Aprea, E. Wuttke, K. Breuer, N.

- K. Koh, P. Davies, B. Greimel-Fuhrmann & J. S. Lopus (Eds.), *International Handbook of Financial Literacy*. Singapore: Springer. doi: 10.1007/978-981-10-0360-8\_15
- Hira, T. K. (2012). Promoting sustainable financial behaviour: implications for education and research. *International Journal of Consumer Studies*, 36(5), 502-507. doi: 10.1111/j.1470-6431.2012.01115.x
- Homer, P. M., & Kahle, L. R. (1988). Personality Processes and Individual Differences: A Structural Equation Test of the Value-Attitude-Behavior Hierarchy. *Journal of Personality and Social Psychology*, 54(4), 638-646. Retrieved from <https://psycnet.apa.org/record/1988-21933-001>
- Huston, S. J. (2010). Measuring Financial Literacy. *Journal of Consumer Affairs*, 44(2), 296-316. doi: 10.1111/j.1745-6606.2010.01170.x
- Jian, J., Chen, C., & Chen, F. (2014). Consumer financial capability and financial satisfaction. *Social Indicators Research*, 118(1), 415-432. doi: 10.1007/s11205-013-0414-8
- Joo, S., & Grable, J. (2004). An Exploratory Framework of the Determinants of Financial Satisfaction. *Journal of Family and Economic Issues*, 25(1), 25-50.
- Kempson, E., Perotti, V., & Scott, K. (2013). *Measuring financial capability: a new instrument and results from low- and middle-income countries*. Washington, DC: World Bank.
- Loke, V., Choi, L., & Libby, M. (2015). Increasing Youth Financial Capability: An Evaluation of the MyPath Savings Initiative. *Journal of Consumer Affairs*, 49(1), 97-126. doi: 10.1111/joca.12066
- Lusardi, A., & Mitchell, O. S. (2011). Financial Literacy and Planning: Implications for Retirement Well-being. In O. S. Mitchell & A. Lusardi (Eds.), *Financial Literacy: Implications for Retirement Security and the Financial Marketplace*. Oxford: Oxford University Press. doi: 10.1093/acprof:oso/9780199696819.003.0002
- Lusardi, A., & Mitchell, O. S. (2014). The Economic Importance of Financial Literacy: Theory and Evidence. *Journal of Economic Literature*, 52(1), 5-44. doi: 10.1257/jel.52.1.5
- Lusardi, A., Mitchell, O. S., & Curto, V. (2010). Financial Literacy among the Young. *Journal of Consumer Affairs*, 44(2), 358-380. doi: 10.1111/j.1745-6606.2010.01173.x
- Lusardi, A., & Mitchell, O. S. (2007). Financial Literacy and Retirement Preparedness: Evidence and Implications for Financial Education. *Business Economics*, 42(1), 35-44. doi: 10.2145/20070104
- Luukkanen, L., & Uusitalo, O. (2019). Toward Financial Capability: Empowering the Young. *Journal of Consumer Affairs*, 53(2), 263-295. doi: 10.1111/joca.12186
- Meyers, L. S., Gamst, G. C., & Guarion, A. J. (2013). *Performing data analysis using IBM SPSS*. New Jersey: Wiley.
- Mudzingiri, C., Muteba Mwamba, J. W., & Keyser, J. N. (2018). Financial behavior, confidence, risk preferences and financial literacy of university students. *Cogent Economics and Finance*, 6(1), 1-25. doi: 10.1080/23322039.2018.1512366
- Pallant, J. (2016). *SPSS survival manual: a step by step guide to data analysis using IBM SPSS*. New York: McGraw-Hill.
- Potocki, T., & Cierpiel-Wolan, M. (2019). Factors shaping the financial capability of low-income consumers from rural regions of Poland. *International Journal of Consumer Studies*, 43(2), 187-198. doi: 10.1111/ijcs.12498

- Potrich, A. C. G., Vieira, K. M., & Kirch, G. (2015). Determinants of Financial Literacy: Analysis of the Influence of Socioeconomic and Demographic Variables. *Revista Contabilidade & Finanças*, 26(69), 362-377. doi: 10.1590/1808-057x201501040
- Potrich, A. C. G., Vieira, K. M., & Kirch, G. (2018). How well do women do when it comes to financial literacy? Proposition of an indicator and analysis of gender differences. *Journal of Behavioral and Experimental Finance*, 17, 28-41. doi: 10.1016/J.JBEF.2017.12.005
- Potrich, A. C. G., Vieira, K. M., & Mendes-Da-Silva, W. (2016). Development of a financial literacy model for university students. *Management Research Review*, 39(3), 356-376. doi: 10.1108/MRR-06-2014-0143
- Rai, K., Dua, S., & Yadav, M. (2019). Association of Financial Attitude, Financial Behaviour and Financial Knowledge Towards Financial Literacy: A Structural Equation Modeling Approach. *FIIB Business Review*, 8(1), 51-60. doi: 10.1177/2319714519826651
- Remund, D. L. (2010). Financial Literacy Explicated: The Case for a Clearer Definition in an Increasingly Complex Economy. *Journal of Consumer Affairs*, 44(2), 276-295. doi: 10.1111/j.1745-6606.2010.01169.x
- Robb, C. A., & Woodyard, A. S. (2011). Financial Knowledge and Best Practice Behavior. *Journal of Financial Counseling and Planning*, 22(1), 60-70. Retrieved from <https://ssrn.com/abstract=2061308>
- Rothwell, D. W., Khan, M. N., & Cherney, K. (2016). Building Financial Knowledge Is Not Enough: Financial Self-Efficacy as a Mediator in the Financial Capability of Low-Income Families. *Journal of Community Practice*, 24(4), 368-388. doi: 10.1080/10705422.2016.1233162
- Serido, J., Shim, S., & Tang, C. (2013). A developmental model of financial capability: A framework for promoting a successful transition to adulthood. *International Journal of Behavioral Development*, 37(4), 287-297. doi: 10.1177/0165025413479476
- Sherraden, M. S., & Ansong, D. (2016). Financial Literacy to Financial Capability: Building Financial Stability and Security. In C. Aprea, E. Wuttke, K. Breuer, N. K. Koh, P. Davies, B. Greimel-Fuhrmann, & J. S. Lopus (Eds.), *International Handbook of Financial Literacy*. Singapore: Springer. doi: 10.1007/978-981-10-0360-8
- Shih, T. Y., & Ke, S. C. (2014). Determinates of financial behavior: Insights into consumer money attitudes and financial literacy. *Service Business*, 8(2), 217-238. doi: 10.1007/s11628-013-0194-x
- Shim, S., Serido, J., Bosch, L., & Tang, C. (2013). Financial identity-processing styles among young adults: A longitudinal study of socialization factors and consequences for financial capabilities. *Journal of Consumer Affairs*, 47(1), 128-152. doi: 10.1111/joca.12002
- Taylor, M. (2009). The impact of life events on financial capability: Evidence from the BHPS. *Financial Services Authority Consumer Research*, No. 79. Retrieved from <https://www.fca.org.uk/publication/research/fsa-crpr79.pdf>
- Vieira, K. M., Caroline, A., & Potrich, G. (2019). A Financial Literacy Model for University Students. In W. Mendes-Da-Silva (Ed.), *Individual Behaviors and Technologies for Financial Innovations*. Austin, Texas: Springer. doi: 10.1007/978-3-319-91911-9\_4
- Vlaev, I., & Elliott, A. (2017). Defining and influencing financial capability. In R. Ranyard (Ed.), *Economic Psychology*. Chichester: Wiley. doi: 10.1002/9781118926352.ch12

- Woodyard, A., & Robb, C. (2012). Financial Knowledge and the Gender Gap. *Journal of Financial Therapy*, 3(1), 1-16. doi: 10.4148/jft.v3i1.1453
- Xiao, J. J., Chen, C., & Chen, F. (2014). Consumer Financial Capability and Financial Satisfaction. *Social Indicators Research*, 118(1), 415-432. doi: 10.1007/s11205-013-0414-8
- Xiao, J. J., Chen, C., & Sun, L. (2015). Age differences in consumer financial capability. *International Journal of Consumer Studies*, 39, 387-395. doi: 10.1111/ijcs.12205
- Xiao, J. J., & O'Neill, B. (2016). Consumer financial education and financial capability. *International Journal of Consumer Studies*, 40(6), 712-721. doi: 10.1111/ijcs.12285

### **Contact information**

#### **Gentjan Çera**

Tomas Bata University in Zlín, Faculty of Management and Economics  
Mostní 5139, 76001, Zlín, Czech Republic  
E-mail: cera@utb.cz  
ORCID: 0000-0002-9324-181X

#### **Bekim Poleshi, M.Sc.**

Epoka University, Faculty of Economics and Administrative Sciences  
Rr. Tiranë-Rinas, Km. 12, 1032 Vorë, Tirana, Albania  
E-mail: bekimpoleshi7@gmail.com  
ORCID: 0000-0002-4330-7008

#### **Khurram Ajaz Khan**

Tomas Bata University in Zlín, Faculty of Management and Economics  
Mostní 5139, 76001, Zlín, Czech Republic  
E-mail: khan@utb.cz  
ORCID: 0000-0001-5728-8955

#### **Arjan Shumeli, Associated professor**

Agricultural University of Tirana, Faculty of Economics and Agribusiness  
“Pajsi Vodica”, 1029 Tirana, Albania  
E-mail: ashumeli@ubt.edu.al  
ORCID: 0000-0002-3737-8176

#### **Oksana Kojku, M.Sc.**

Agricultural University of Tirana, Faculty of Economics and Agribusiness  
“Pajsi Vodica”, 1029 Tirana, Albania  
E-mail: oksana.kojku@gmail.com  
ORCID: 0000-0002-5387-7872

doi: 10.7441/dokbat.2019.018

# PRODUCTION OF CO<sub>2</sub> EMISSIONS FROM MARITIME CONTAINER SHIPPING IN COMPARISON WITH ROAD CONTAINER TRANSPORT

*Iris Čeh*

## Abstract

Maritime trade accounts for approximately 90% of whole world trade. Maritime Container Shipping is one of the fastest growing branches in the world. It can often be found in the literature, that container shipping is the largest polluter in the world, which requires measures that reduce the speed of ships to slow steaming between 18 - 20 knots. Although transport is one of the human most important activities nowadays, is responsible for 40% of CO<sub>2</sub> emissions. In maritime transport, CO<sub>2</sub> emissions are still hardly regulated especially in international shipping. No such an adequate model, to determine the exact payer of occurred emissions, have been discovered until now. The research shows the difference between maritime container shipping and road container transport and the percentage of CO<sub>2</sub> emissions that road transport represents when transshipping a container from Warehouse in the country of origin to Warehouse in the destination country. The research has shown that road container transport would emit much more CO<sub>2</sub> emissions than maritime container shipping. Throughout the research, an average container vessel of 8,000 TEU capacity, sailing at 21 knots and consuming 150 tons of bunker fuel oil was used for calculations. The aim of this paper, based on literature review, is the analysis of advantages and consequences of maritime container shipping pollution. The main accent is given to a speed reduction of container vessels for few knots and to this related significant drop of CO<sub>2</sub> emissions.

*Keywords:* Maritime Container Shipping, speed reduction, transport, Containerization, CO<sub>2</sub> emissions

## 1 INTRODUCTION

Today, world trade is full of new electronic payment systems, including e-wallets, prepaid applications and more. Increased mobility of capital is crucial in globalization as money can move freely from country to country. Over the last 30 years, trade openness, defined as the export-import ratio, has increased from 25% to around 40% for industrialized economies and from 15% to 60% for emerging economies. The emergence of global multinationals and the rise in the importance of brands such as Microsoft, Apple, Google, Sony, and McDonalds have been crucial to development of globalization (Černetič, 2007).

Logistics can generally be an instrument that controls global trading, mainly due to transcontinental transport. Logistics companies need to adapt flexibly to upcoming trends and be able to make quick decisions. The strength of logistics means that it can replace one-way transport with multiple-way transport. Manufacturers and dealers can integrate all logistics services into their activities, thus increasing the value of the price and saving more than subcontracting. This type of internal logistics management can be many times more effective for the company itself, but it depends on the size and core business of the company. Globalization is such a driving force for logistical activity, and with-it new trade flows are increasing, their volume is increasing, and new markets and opportunities are opening up. Due to the increased competition, that globalization brings with it, companies are thus forced to reorganize and adapt their systems to global change (Černetič, 2007).

The two biggest challenges in shipping and logistics are (Černetič, 2007): (1) Establishing a network of links to support the trade of goods around the world while meeting the flow of goods. In recent years, the trend is for smaller companies to merge and then take over global logistics freight forwarders, causing further expansion of networks around the world; (2) Another clear tendency is the integration of transport, freight forwarding and logistics services.

## **2 THEORETICAL BACKGROUND**

Global climate change is a serious problem nowadays. The temperature of the atmosphere is increasing as the heat waves becoming more intense and more frequent. Global warming and air pollution are largely the result of greenhouse gas emissions from transport and fossil fuels (Kakouei, Vatani & Idris, 2012). Every degree of Celsius caused by CO<sub>2</sub>, would annually lead up to upward of 20000 air-pollution-related deaths (Whitty, 2008). The five most important pollutants controlled by the Kyoto Protocol (2008-2012) are: methane (CH<sub>4</sub>), nitrous oxide (N<sub>2</sub>O), hydrocarbons (HFC), sulphur hexafluoride (SF<sub>6</sub>) and the most problematic Carbon dioxide (CO<sub>2</sub>). Air pollution from transport is a mixture of particles and gases that reach harmful concentrations outside and indoors (Selin & Cowing, 2018).

Carbon emissions are the most significant of greenhouse gas emissions that cause global warming (Dosio et al., 2018). Increased concentration of CO<sub>2</sub> can lead to various health problems. The effects of CO<sub>2</sub> on an individual are dependent on the concentration and duration of exposure. The level of carbon dioxide does not necessarily affect our ability to breathe. With the transformation of the planet, these CO<sub>2</sub> levels will continue to rise dramatically and related to that, diseases will increase drastically; extreme weather events including heat waves will appear mosquito and tick related diseases will spread. Currently, CO<sub>2</sub> levels are still rising rapidly. 550 ppm could be reached by the end of the century, what will raise global temperatures up to 6 degrees Celsius (the Paris Agreement aims to limit warming to less than 2 degrees C) (Engineering ToolBox, 2009).

The industrial revolution has led to a significant increase in CO<sub>2</sub> emissions. CO<sub>2</sub> accounts for 72% of all greenhouse gases. Decomposing of CO<sub>2</sub> from the atmosphere degrades 100-200 years what leads to the fact that CO<sub>2</sub> accumulate in the atmosphere. Therefore, the European Union has adopted a directive that the atmosphere should not be heated by more than 2 degrees Celsius, which means a significant reduction in CO<sub>2</sub> emissions. From the very beginning, transport planners and founders of transit and real estate were interested in those markets that supported transit services, especially in the area of public transport (Feigon, Hoyt & McNally, 2003).

With smart traffic management, users can choose new and smarter modes of transport such as public transport, car sharing, hybrid vehicles, electric vehicles, etc. It is on the EU's side to regulate what traffic can be used in cities, out-of-cities, or just manage smart traffic, such as green waves at traffic lights. By implementing such management, we reduce fuel consumption, CO<sub>2</sub> emissions and environmental impact. Correlation is always proportional as fuel consumption increases, as do emissions and environmental impacts (Jereb & Čeh, 2017).

Sustainable development of modern city nowadays consists of well develop infrastructure on first place, which is a representation of populations quality life. The choice of freight transportation mode is crucial when it comes to reducing emissions and costs. It has a profound effect on logistic, companies, infrastructure and whole population. Fast market concentration means that supply chain needs to adapt rapidly to all market-changing conditions.

Market concentrating contributes to increasing pollution, and the European Union can make a huge difference with regulations in the area of reducing transport emissions. The EU 2030



framework contains targets to reduce CO<sub>2</sub> emissions by at least 40% since 1990, enabling the EU to take cost-effective measures to achieve the long-term (2050) CO<sub>2</sub> reduction targets of 80-95%, in the context of reducing extraordinary emissions. The European Union calls for CO<sub>2</sub> emissions to be reduced to 20 gigatons by 2050. These regulations covered by the White Paper, also contains several other measures to reduce EU traffic. These include the introduction of more integrated and efficient transport system, the accelerated introduction of modern vehicle and fuel technologies and the promotion of cleaner modes of transport (European Commission, n.d.).

The growth of freight transport is increasing road congestion and many cities already have concerns about trucking in cities. There are already restrictions on truck weight in some parts of the cities, and there is a growing tendency to restrict truck access to cities during off-hours. In the Netherlands, there is constant congestion around the port of Rotterdam and at freight terminals. They decided to develop separate underground road networks for freight vehicles. Full door-to-door service is one of the great advantages it has. The problem arises in limitation. The amount that road freight transport can carry in one fell swoop is small (Bowen & Rodrigue, 2017).

This is why the need for port adaptation has increased, vessels and inland infrastructure and suprastructure has become one of the main factors in the adaptation of cargo handling equipment in ports and vessels, which has led to the further development of maritime container shipping (Lee & Song, 2017). Since 2008, maritime trade has accounted for as much as 89.6% of world trade. Maritime transport is one of the most globalized industries in terms of business. The importance and configuration of shipping routes has changed with economic development and technical improvements, among which we consider containerization that has changed the freight routes with innovative services. Maritime transport is now largely focused on freight, as there are no other effective alternatives for transporting large volumes of freight over long distances (Bowen & Rodrigue, 2017).

The systematic growth of maritime freight has been encouraged (Bowen & Rodrigue, 2017): (a) Link to the geographical distribution of resources, meaning that production is usually located elsewhere than sales, so large volumes of freight need to be transported over long distances; (b) Lower costs and quantity of freight transported. Globalization has encouraged long-distance trading, which has supported the development of containerization; (c) Technical improvements to ships and maritime terminals have helped to increase efficiency in terms of throughput and handling of several types of cargo, allowing long-distance trading; and (d) Economy of scale has helped larger ships and make transportation more cost effective.

Prior to containerization, loading or unloading a ship was very expensive and time consuming, and the cargo ship usually spent more time in port than at sea. Currently, the ship sailing about 70% of its time and only 30% in ports (Ministrstvo za šolstvo in šport RS, n.d.). Nowadays, the trend of the costs reduction is still one of the most important factors in the industry. For carriers it can be achieved through mega container vessels, slow steaming and further market consolidations (Lee & Song, 2017).

The world's largest commercial shipping operator, A.P. Moller-Maersk AS intends to break the current 80% of container shipping earnings into 50% of container shipping and 50% of land-based operations. In doing so, it seeks to approach larger companies such as Walmart Inc. and provide them with land transportation services. One of the reasons for land expansion is also the pressure of a growing "trade war" between America and China. Container shipping has been declining for some time now. In 2011, traffic totalled about \$ 60 billion, and in 2016, it dropped to about \$ 35 billion. Maersk Line has approximately 70,000 customers at sea, carrying around 20% of the world's containers. Less than a quarter of their customers still use subcontractors/

freight forwarders for container manipulation from origin Warehouse to port. This in praxis means, that customers use only shipping companies for the whole service. For Maersk and some other shipping companies, manipulation of containers before and after the departure of vessels, becomes much more interesting, due to the ocean freight earning decline (Paris, 2019a).

The maritime sector is responsible for a large proportion of global pollution and contributes more than three percent of global CO<sub>2</sub> emissions, and the industry continues to grow rapidly. Such a percentage of CO<sub>2</sub> emissions is comparable to developed countries. If shipping could be equated with the country, it would be sixth in terms of the amount of CO<sub>2</sub> emissions produced. Only the United States, China, Russia, India and Japan would be ahead (Oceana, n.d.). Despite all the numbers, CO<sub>2</sub> emissions from shipping are still largely unregulated as authorities disregard CO<sub>2</sub> emissions from international shipping. The problem arises when no country took responsibility and considers that emissions would never occur, and nothing is done on reduction. Scientists have developed several emission allocation theories, such as the allocation of CO<sub>2</sub> emissions by location of sold fuel, location of registered ships or origin of ships. The first and most basic step towards results, however, must be an open international database on international maritime shipping and emissions, which does not yet exist (Selin & Cowing, 2018).

The international shipping industry is committed to halving greenhouse gas emissions by 2050. In the background, however, there is a huge catch, as there are currently not so many powerful engines and such clean fuel on the market that could be achieved. The restructuring of tighter emissions will therefore require the investment of billions of dollars. There is almost unanimous agreement that ships, which have burned heavy oil, the most polluting propulsion bunker fuel, since they switched from coal in the early 20th century, must clean up. However, nobody is quite sure how it can be done. To comply with the 2015 Paris climate accord IMO members have agreed to improve fuel efficiency by 30% by 2025 and pegged to slash greenhouse-gas emissions by half by 2050 from 2008 levels. Ship life is approximately 25 years, so any new orders over the next decade will be based on new designs that use biofuels, ammonia, hydrogen, batteries or some other alternative fuel to power it (Paris, 2019a).

Starting Jan. 1, 2020, some 60,000 ocean-going ships will be obliged to cut their sulphur emissions by more than 80%. A new regulation will come into force to reduce air pollution from ships globally. Whereas today ships can use fuel with up to 3.5% Sulphur content (outside Emission Control Areas), the new global Sulphur cap will be 0.5%. The cost of compliance with the new regulation will be significant, so the cost of shipping will increase. Many are already preparing to switch to new low-sulphur fuel, a move that industry executives say will add some \$50 billion in costs over the next 3-4 years (Paris, 2019b).

CMA CGM will be first ship-owner in world to equip its nine future 23,000-TEU vessels with engines powered by liquefied natural gas (LNG). With LNG, the Group has made a ground-breaking choice that goes beyond current and future environmental regulations. In 2022, the CMA CGM fleet will include 20 LNG-powered vessels, including nine vessels of 23,000 TEUs (delivery from 2020); five vessels of 15,000 TEUs; and six vessels of 1,400 TEUs, of which three have already been delivered to Containerships.

LNG is a clean energy, currently considered as the least polluting type of fossil fuel. A substitute for Bunker fuel oil, LNG reduces greenhouse gas emissions and improves air quality by limiting polluting emissions. A real technological breakthrough contributing to environmental protection, LNG offers the following benefits over existing fuel oil-powered ships: (a) reduction of up to 20% in CO<sub>2</sub> emissions; (b) 99% reduction in Sulphur emissions; (c) 99% reduction in fine particles emissions; and (d) 85% reduction in nitrogen oxide emissions. In addition, the Energy Efficiency Design Index (EEDI), which measures the environmental footprint of a

vessel, improved by 20% compared to a conventional vessel. The result is a reduced carbon footprint and improved air quality, particularly for populations living in coastal areas and in port cities (CMA CGM, 2019).

### **3 METHODOLOGY**

The article is based on the calculation of CO<sub>2</sub> emissions produced by a container ship with a capacity of 8,000 TEU compared to transporting the same amount of TEU by road transport. The calculation considers the origin port Koper. The research is divided into three main sections: (1) The comparison of CO<sub>2</sub> emissions emitted from road transport of 8.000 20'DV containers and from container ship transporting the same quantity; (2) Percentage share of CO<sub>2</sub> emissions along the entire route represented by the delivery of the container by truck, from company to port and from port to company at destination; (3) What a reduction/increase in CO<sub>2</sub> emissions would represent a slower/faster sailing from the baseline speed of 21 knots that was taken into account.

There were three different methods used throughout the research: (1) Descriptive method was used in the theoretical part of my thesis. (2) The compilation method was used to summarize definitions by different authors and sources on issues of emissions, globalization, modes of transport, etc. (3) In the comparison method, emissions between the two modes of transport and the amount of emissions at different container ship speeds, were compared. However, 10 random destination ports / locations are selected, which are also accessible by road: Jeddah, Singapore, Shanghai, Bangkok, Durban, Yokohama, Trieste, Bremerhaven, Chennai and Piraeus.

Based on the transit times of the ship/ travelled kilometres from truck and the converter (how much CO<sub>2</sub> is released from 1 litre of diesel fuel and 1 ton of Bunker fuel), the CO<sub>2</sub> emissions consumption of each destination is calculated. The number of journeys that trucks would have to make to transport such a TEU is considered. The actual emissions that will be generated if such a quantity of containers were transported by road are compared with those of maritime container shipping.

Maritime container shipping shows the problem of inaccessibility of ships where containers can be delivered more than 50, 200, 300 km by truck or rail to the exit port/destination - and therefore we need to use multimodal transport such as Truck /Rail - Ship - Truck/Rail. The percentage of CO<sub>2</sub> emissions represented by the delivery of the container by truck from the dispatch Warehouse/Company to the destination Warehouse/Company, is calculated.

From the randomly selected company X, located in Slovenia, the goods then delivered by road to the Port of Koper. However, near each destination port there are randomly assigned warehouses/companies marked P1, P2, P3, P4, P5, P6, P7, P8, P9, P10. From the ports of destination, such goods are shipped to selected warehouses/companies.

These two modes of transport are compared because of the inaccessibility of ships inland, where delivery by truck must then also take place. Road transport is known as the "practical" mode of short distance transport, but most major cities are always struggling to concentrate it in city centres. On the other side there is a location problem of the ports themselves, which are more or less all over the world, located in the centre of the cities, which means that this creates additional pollution pressure on the cities.

## 4 RESULTS

### 4.1 CO2 Emissions by maritime container shipping

An average container vessel of 8000 TEU capacity, which produces an average of 150 t CO2 emissions per day, with a sailing speed of 21 knots is used in the research (The Geography of Transport Systems, n.d.). For vessels, bunker fuel consumption is measured in days and tones. Information about different routes transit time is widely available on the websites of the shipping companies where we can check the transit times of shipping. To calculate CO2 emissions from the consumption of Bunker fuel used tones, i used following converter: 3.11 t of CO2 emissions is produced from the spent 1 ton of bunker fuel oil (Engineering ToolBox, 2009). Bellow Table 1 shows the average duration of all routes, the amount of fuel consumed tones and the final CO2 emissions of a container ship on each route.

Tab. 1 – CO2 emissions by maritime container transport. Source: own research

Destination port	Average route duration [day]	Consumed fuel [t]	CO <sub>2</sub> Emissions [t]
	Port Koper	Port Koper	Port Koper
Jeddah	12	1800	5598,0
Singapore	27	4050	12.595,5
Shanghai	47	7050	21.925,5
Bangkok	30	4500	13.995,0
Durban	36	5400	16.794,0
Yokohama	52	7800	24.258,0
Trieste	1	150	466,5
Bremerhaven	12	1800	5598,0
Chennai	29	4350	13.528,5
Piraeus	3	450	1399,5

The amount of consumed fuel is calculated based on the transit times of each route and the average consumption of vessel, which is in my case 150 t / day. Using the amount of fuel consumed tones and the bellow mentioned equation, the total CO2 emissions from vessel on its way are calculated.

$$3,11 t * \text{amount of fuel consumed [t]} = CO_2 [t] \quad (1)$$

### 4.2 CO2 Emissions by road container transport

This chapter calculates the CO2 emissions from road transport, if trucks transported long-haul containers with a capacity of 2 TEU / truck. From a practical point of view, the truck is a good choice, as it has the ability to access the warehouse directly, which the vessel does not have. Maritime container shipping must always use a combined form of transport to get the container to the recipient's warehouse and then again, with another type of transport (truck / train) returns back to port or terminal. An average diesel truck with an average consumption of 25 l / 100 km was used to calculate the CO2 emissions produced (Transport & Logistik, 2018). 1 liter of diesel fuel produces 2.67 kg of CO2 emissions. The CO2 emissions are divided, as shown in Table 2, into those of single container transport and multiple transport. It is estimated that an 8000 TEU truck would have to travel the same route 4000 times to transport all containers. The formula below shows the calculation of CO2 emissions by multiplying the CO2 emission from 1 liter of diesel by the amount of fuel consumed and then divided by 1000 to get the value in tones.

$$\frac{2,67 \text{ kg } CO_2 * \text{amount of fuel consumed[l]}}{1000} \quad (2)$$

Taking the truck's travel time into account, it would appear that travel times are generally 4-5 times longer, which consequently leads to higher fuel consumption and higher CO2 emissions

Tab. 2 – CO2 emissions by road transport. Source: own research

Destination port	Driven kilometers	Consumed fuel [l]	CO <sub>2</sub> Emissions from single transport [t]	Number of rides	CO <sub>2</sub> Emissions from multiple transport [t]
	Port Koper	Port Koper	Port Koper	Port Koper	Port Koper
Jeddah	<b>4685,96</b>	1171,49	3,13	4000	12.511,51
Singapore	<b>12.472,44</b>	3118,11	8,33	4000	33.301,41
Shanghai	<b>10.917,37</b>	2729,34	7,29	4000	29.149,38
Bangkok	<b>10.834,13</b>	2708,53	7,23	4000	28.927,13
Durban	<b>12.688,62</b>	3172,16	8,47	4000	33.878,62
Yokohama	<b>12.337,6</b>	3084,40	8,24	4000	32.941,39
Trieste	<b>22,86</b>	5,72	0,02	4000	61,04
Bremerhaven	<b>2302,06</b>	575,52	1,54	4000	6146,50
Chennai	<b>8980,94</b>	2245,24	5,99	4000	23.979,11
Piraeus	<b>1669,87</b>	417,47	1,11	4000	4458,55

### 4.3 Comparison of CO2 emissions from maritime container shipping and road container transport

As it is quite logical that CO2 emissions increasing as the route is extended, it was not my intention to calculate and show what is already known, but to show a comparison between the CO2 emissions produced by transporting 8000 TEU, either by ship or by road. Figure 1 graphically shows that CO2 emissions from road transport at 8000 TEU are on average, higher than by shipping, with exception of the route between Port of Koper and Trieste, where container ship produces 405 tons of CO2 more than a truck if it has to travel the same route 4000 times. This is due to the very short road distance between the Port of Koper and the Port of Trieste. The route is only 23 km long.

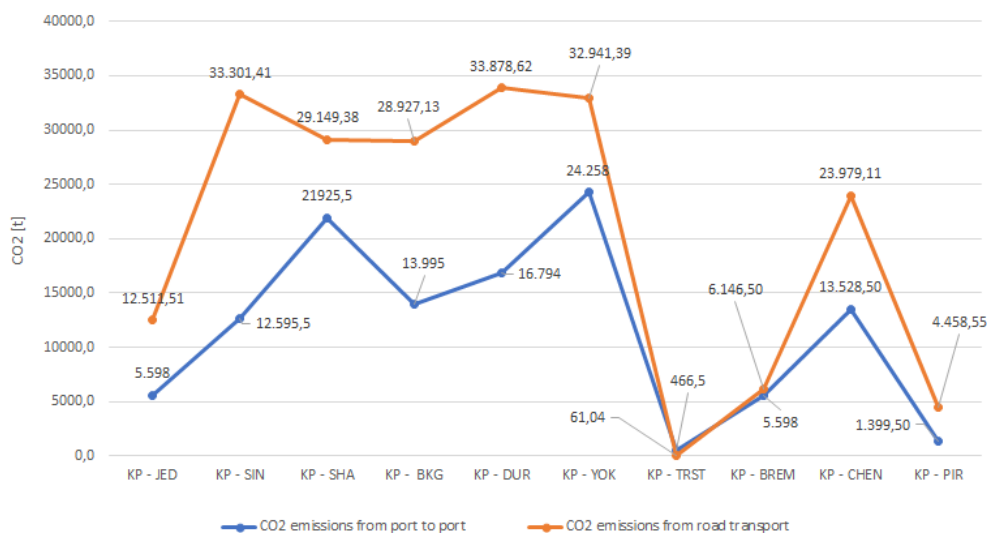

Fig. 1 – Comparison of CO2 from maritime container and road container transport. Source: own research

When calculating the difference in average lengths between shipping (1 time) and road transport (4000 times), it turns out that on average, road transport routes are 30,747,628.4 km longer than shipping. A relatively small difference in emissions found on the route between Koper and Bremerhaven, where the reason is again the same as for the route between Koper and Trieste, namely a small road distance of only 2300 km, with a single container transport. The difference

in emissions is only 549 tons of CO2 emissions, and thus road transport produces 1.2 times more CO2 emissions than shipping.

Due to the waste of time and truck regulations regarding the restrictions on driving hours and the speedy use of vehicles, of course we do not use such transports. Otherwise, the cost of such transportation would also be incomparably higher, but the route would be time wasting and unused. In addition to the ship, a large amount of TEU is also used by the railway, which is more time wasting and insufficient for such a TEU quantity. Road transport emissions are, on average, 1.78 times higher than those from maritime container shipping. The biggest difference in CO2 emissions is the last route, between Koper and Piraeus, where the truck produces 3.2 times more emissions as a ship to the same port. The number of kilometres and the transit time of the ship influences the difference factor from port to port.

#### 4.4 Percentage of road CO2 emissions along the Warehouse-Warehouse route

The CO2 emissions from maritime container shipping, calculated in section 4.1, are not the total emissions of container transport, since the entire container transport route also includes the road transport, from the warehouse to the port of origin and then from the port of destination to the consignees warehouse. Of course, road transport is not the only way; the rail is also an option, but in the following, I have considered only truck - vessel – truck combined transport.



Fig. 2 – Division of combined transport routes. Source: own research

For the calculation of emissions from warehouse to warehouse, a randomly selected company X is used, in the origin country of Slovenia, and then the same in each country of destination from P1 to P10, as it is represented in Table 3. The entire route is divided into 2 road sections (X-Lk, L1-10-P1-P10) and the maritime shipping route (Lk-L1-10), as represented on Figure 2. All kilometres from Lk – X (Lk – Luka Koper) and L1-10 – P1 – P10 (L1-10 – all 10 destinations) are duplicated, since I assumed that the container was being picked up in port and returned to port.

Tab. 3 – Calculation of CO2 emissions from company to port. Source: own research

Warehouses	X	P1	P2	P3	P4	P5	P6	P7	P8	P9	P10
Number of kilometers [km]	218	46	120	37,6	708	16,6	2	24	140	123,4	28,6
Consumed fuel[l]	54,5	11,5	30	9,4	177	4,15	0,5	6	35	30,85	7,15
CO <sub>2</sub> emissions[t]	145,5	30,7	80,1	25,1	472,6	11,1	1,3	16,0	93,4	82,4	19,1
Associated port	KOP	JED	SIN	SHA	BKG	DUR	YOK	TRST	BREM	CHEN	PIR

Table 4 below shows the total CO2 emissions from road transport from Company X to P1 – P10, which are expressed as a percentage in the third column by the total container path. On average, road transport produces 4.72% of the total route's CO2 emissions.

Tab. 4 – CO2 emissions from road transport from warehouse to warehouse. Source: own research

CO <sub>2</sub> emissions from road transport from Warehouse to Warehouse [t]	X	Percentage of total route [%]
P1	176,2	3,05
P2	225,6	1,76
P3	170,6	0,77
P4	618,1	4,23
P5	156,6	0,92
P6	146,8	0,60
P7	161,5	25,72
P8	238,9	4,09
P9	227,9	1,66
P10	64,6	4,41

It depends a lot on where the Warehouse is located, so I randomly select companies that could be very far from the ports or nearby. As shown in the Table 3, the largest percentage share of the road part of CO<sub>2</sub> emissions is contributed by a company in Italy, which is only 24 km away from the Port of Trieste. This is because the vessel transit time between the Port of Koper and the Port of Trieste is only 1 day, which means that CO<sub>2</sub> emissions from the maritime container shipping are rather low. Let me emphasize that this is merely a theoretical account of the CO<sub>2</sub> emissions released into the atmosphere by everyday maritime container traffic. Namely, from the Port of Koper to the Port of Trieste it is not sensible to transport the container by ship, as the research in chapter 4.3 showed, that road container transport, produces only 61.04 t of CO<sub>2</sub> emissions and the maritime container shipping as much as 466.5 t.

In any case, the speed of sailing is very important when talking about CO<sub>2</sub> emissions released into the atmosphere. Whole research in the article was calculated based on the 21 knots speed, where 150 tons of CO<sub>2</sub> emissions are released into the atmosphere per day.

The following section presents a study on the reduction and increase of CO<sub>2</sub> emissions by subtracting or adding a few knots to 21-speed vessels.

#### **4.5 Reduction of CO<sub>2</sub> emissions from maritime container shipping**

The three most important factors affecting the consumed amount are: speed of the vessel, the size of the ship and the length of the route, which effects on CO<sub>2</sub> emissions. The baseline size of a container ship, that was used for the research, has the capacity of 8000 TEU and sailing speed 21 knots, which is a relatively average vessel, sailing with average speed. In section 3.1, the emissions from such vessel were already calculated. A few knots were added and taken to the average speed of sailing with 21 knots. The results were then compared between each other.

Figure 3 below shows the average vessel fuel consumption of 17, 19, 20, 21, 23, 24 and 25 knots. Between slowest and fastest sailing is 170 tons difference, which is even 20 tons more that was used in the research. It is important to note that the extension or shortening of ship transit time due to slower and faster sailing is neglected. All considered transit times are calculated at a sailing speed of 21 knots. On the Maersk ship owner's website, where the data was taken from, the transit time is constantly changing depending on the carriers sailing speed adjustment.

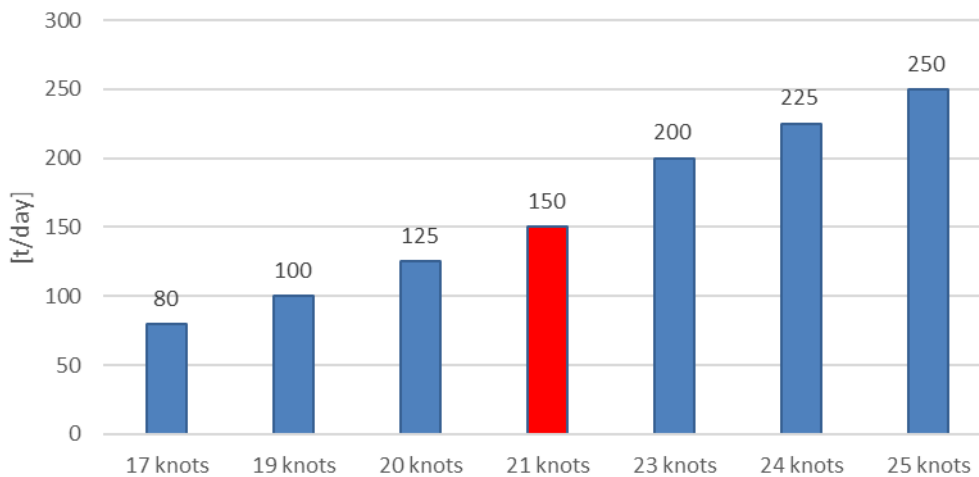

Fig. 3 – Average fuel consumption relative to sailing speed. Source: own research

According to Figure 2, tentative results has been expected, since CO<sub>2</sub> emission production depends on fuel consumption and the length of the ship's route. Koper-Yokohama (52 days) and Koper-Shanghai (47 days) are the longest routes the ship has to travel. Figure 4 shows that the ship produces the most CO<sub>2</sub> emissions on these two routes. On the route from Koper to Yokohama, at a maximum speed of 25 knots, the ship produces as much as 40,430 tones and on the route between Koper and Shanghai 36,542.5 tones. The upper CO<sub>2</sub> production value of 25 knots is over 40% higher than the middle value (21 knots). However, the lower CO<sub>2</sub> emission value for a 17-knot sailing is 47% lower than the medium value for a 21-knot sailing. The medium value is coloured red due to more visible representation.

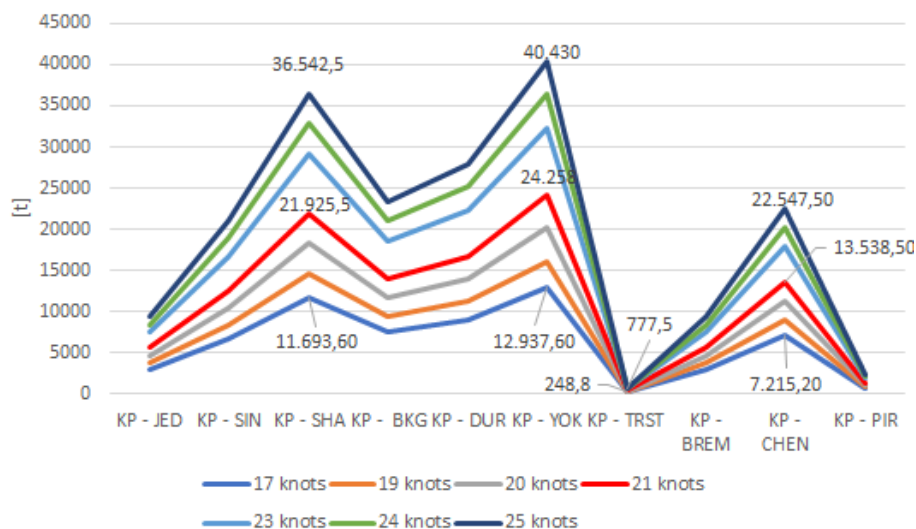

Fig. 4 – Average fuel consumption relative to sailing speed. Source: own research

If a ship sailing between Koper and Shanghai, instead of speeding at 21 knots, sailed slowly at 17 knots, it would emit as much as 10,231.9 tons of CO<sub>2</sub> emissions less. For a 25-knot float, this difference would represent as much as 24,849 tons of CO<sub>2</sub> emissions. However, it is also worth mentioning the negative side of slowing down ships, which seems to be happening by 2020, by adapting to IMO 2020 rules. Despite that 90% of world trade is by sea, this would have a significant impact on reducing this percentage and would also reduce global trade in general. Even though such a reduction would save a lot of money on fuel for ship-owners, it would, on the other hand, create a loss due to lower demand. These costs, in turn, will be projected onto customers.



## 5 CONCLUSION

The whole article focuses only on CO<sub>2</sub> emissions and ignores other types of pollution, such as: particulate pollution, other gases (methane, nitrous oxide, hydrocarbons, sulphur hexafluoride, etc.), noise and light pollution, and all other types pollution resulting from human activity. Excessive pollution of our planet with CO<sub>2</sub> emissions began at the beginning of the industrial revolution, when values rose sharply. The fact that  $\frac{3}{4}$  of global warming causes CO<sub>2</sub> emissions is worrying and the consequences not only affect people's breathing difficulties but go deeper. Paradoxically, for every industrialized society, a well-structured transport network is needed to enable us to expand and develop our economy.

Globalization has over the centuries, enabled world trade to expand, easier and greater access to foreign markets, leading to lower production costs and establishing links with specific industry orientations. Logistics companies and users alike had to adapt to all of this. With all the positive effects that globalization brings, many negative effects have also arisen, which are mainly reflected in the pollution and saturation of the planet with emissions.

The article compares the transport of 8000 TEUs with a ship and a truck to 10 different ports around the world and found that road transport of such a quantity of TEUs would produce on average 1.78 times more emissions than a ship. To transport this amount of TEU to all 10 ports of destination, the ship would produce as much as 116,159 tons of CO<sub>2</sub> and the truck would produce 205,355 tons.

An effective way of reducing these numbers is to include, among the first measures, a reduction in the speed of ship navigation, where ships are expected to have to sail between 18-20 knots by 2020. Calculations through the diploma thesis showed that a ship sailing 20 knots on all 10 routes mentioned above would produce 96,798.75 tons of emissions, which is 16.7% less than a ship sailing at 21 knots. By reducing the speed of the ship by 5 knots, we will halve CO<sub>2</sub> emissions and reduce them by as much as 47%.

For comparison, ship that sail with 25,4 knots on all 10 routes mentioned above, producing 77,439 tons of CO<sub>2</sub> emissions more, than ship sailing with 21 knots. If you wanted to plant trees that would synthesize that amount of CO<sub>2</sub>, you would need as many as 65,626 trees that would only be able to synthesize that amount of CO<sub>2</sub> in 10 years (Helmenstine, 2019).

Electric ships are also on the market right now, but they are still very incomplete and can only overcome short distances before they need to be recharged, so they are not yet covered by the CO<sub>2</sub> reduction plan. Most talk is about optimizing ship design, such as hull optimization, propeller and ship conversion to renewable energy, especially wind, where Cargill and Wessels have already presented their first kite experiments. They have already installed different models of rotors on the ships, which would propel the ships into the wind.

Currently, the most pressing problem is the use of bunker fuel oil. Local Pollutant Regulations report that its use in the future is unsustainable and the tendency to use cleaner fuel that produces significantly less carbon dioxide for the plant will be unavoidable (Gilbert, 2018).

### References

- Bowen, D. J., & Rodrigue, J. P. (2017). *Air Transport*. Retrieved from [https://transportgeography.org/?page\\_id=1765](https://transportgeography.org/?page_id=1765)
- CMA CGM (2019). *The CMA CGM JACQUES SAADE: The world's first 23,000 TEU powered by LNG*. Retrieved from <https://cmacgm-group.com/en/launching-cmacgm-jacques-saad%C3%A9-world's-first-ultra-large-vessel-powered-by-lng>

- Černetič, M. (2007). *Management in sociologija organizacij*. Kranj: Moderna organizacija
- Dosio, A., Mentaschi, L., Fischer, E. M., & Wyser, K. (2018). Extreme heat waves under 1.5 °C and 2 °C global warming. *Environmental Research Letters*, 13(5). doi: 10.1088/1748-9326/aab827
- Engineering ToolBox (2009). *Combustion of Fuels - Carbon Dioxide Emission*. Retrieved from [https://www.engineeringtoolbox.com/co2-emission-fuels-d\\_1085.html](https://www.engineeringtoolbox.com/co2-emission-fuels-d_1085.html)
- European Commission (n.d.). *Climate strategies & targets*. Retrieved from [https://ec.europa.eu/clima/policies/strategies\\_en](https://ec.europa.eu/clima/policies/strategies_en)
- Feigon, S., Hoyt, D., & McNally, L. (2003). *TCRP Report 93 Travel matters: Mitigating Climate Change with Sustainable Surface Transportation*. Retrieved from [http://onlinepubs.trb.org/onlinepubs/tcrp/tcrp\\_rpt\\_93.pdf](http://onlinepubs.trb.org/onlinepubs/tcrp/tcrp_rpt_93.pdf)
- Gilbert, P. (2018). *Five ways the shipping industry can reduce its carbon emissions*. Retrieved from <http://theconversation.com/five-ways-the-shipping-industry-can-reduce-its-carbon-emissions-94883>
- Helmenstine, A. M. (2019). *How much oxygen does one tree produce?* Retrieved from <https://www.thoughtco.com/how-much-oxygen-does-one-tree-produce-606785>
- Jereb, B., & Čeh, I. (2017). *The effect of traffic management on CO2 production*. In N. Zrnić, S. Bošnjak, G. Kartnig, B. Dragović & S. Papadimitriou (Eds.), XXII International Conference on Material Handling, Constructions and Logistics. Belgrade: Faculty of Mechanical engineering.
- Kakouei, A., Vatani, A., & Idris, A. K. B. (2012). An estimation of traffic related CO2 emissions from motor vehicles in the capital city of Iran. *Iranian Journal of Environmental Health Science & Engineering*, 9, 1-5. doi 10.1186/1735-2746-9-13
- Lee, C. Y., & Song, D. P. (2017). Ocean container transport in global supply chains: Overview and research opportunities. *Transportation Research Part B: Methodological*, 95, 442-474. doi: 10.1016/j.trb.2016.05.001
- Ministrstvo za šolstvo in šport RS (n.d.). *Osnove kontejnerizacije*. Retrieved from [www.mizs.gov.si/fileadmin/mizs.gov.si/pageuploads/podrocje/Strukturni\\_skladi/Gradi va/MUNUS2/MUNUS2\\_88LogistikaTovornihTokov.pdf](http://www.mizs.gov.si/fileadmin/mizs.gov.si/pageuploads/podrocje/Strukturni_skladi/Gradi%20va/MUNUS2/MUNUS2_88LogistikaTovornihTokov.pdf)
- Paris, C. (2019a). *Maersk CEO wants half its earnings to come from inland logistics*. Retrieved from <https://www.wsj.com/articles/maersk-ceo-wants-half-its-earnings-to-come-from-inland-logistics-11561580963>
- Paris, C. (2019b). *Attaining carbon-neutral shipping is a herculean task*. Retrieved from <https://www.wsj.com/articles/attaining-carbon-neutral-shipping-is-a-herculean-task-11570183200>
- Selin, H., & Cowing, R. (2018). *Cargo ships are emitting boatloads of carbon, and nobody wants to take the blame*. Retrieved from <http://theconversation.com/cargo-ships-are-emitting-boatloads-of-carbon-and-nobody-wants-to-take-the-blame-108731>
- Oceana (n.d.). *Shipping Pollution*. Retrieved from [eu.oceana.org/en/shipping-pollution-1](http://eu.oceana.org/en/shipping-pollution-1)
- The Geography of Transport Systems (n.d.). *Fuel consumption by containership size and speed*. Retrieved from [https://transportgeography.org/?page\\_id=5955](https://transportgeography.org/?page_id=5955)
- Transport & Logistika (2018). *Za 0,4 litra nižja poraba, kot konkurenca*. Retrieved from <http://etransport.si/novice/za-04-litra-nizja-poraba-kot-konkurenca>

Whitty, J. (2008). *CO2 Emissions Kill People*. Retrieved from <https://www.motherjones.com/politics/2008/01/co2-emissions-kill-people>

### **Contact information**

**Iris Čeh**

University of Maribor, Faculty of Logistics

Mariborska cesta 7, 3000 Celje, Slovenia

E-mail: [iris.ceh@student.um.si](mailto:iris.ceh@student.um.si)

ORCID: 0000-0003-2604-6894

doi: 10.7441/dokbat.2019.019

# WHICH FACTORS INFLUENCE CONSUMER ETHNOCENTRISM? THE CASE OF SLOVAKIA

*Marián Čvirik*

## **Abstract**

The main aim of the paper is to measure consumer ethnocentrism in Slovakia and to investigate possible factors of the consumer ethnocentrism level. The article will focus on socio-demographic factors (age, gender, income and level of education), but also it will look at fewer common factors such as Worldmindedness, Patriotism and the national economy assessment, which have not been examined in Slovakia yet. The study is based on a primary survey. A non-probability sample of 300 respondents was used in the research to collect the empirical data. The one-way ANOVA and linear regression analysis were used to explore the impact of selected factors on consumer ethnocentrism in the Slovak population and to do the hypotheses. Results indicate that selected factors (age, gender, income and level of education, Worldmindedness, Patriotism and the national economy assessment) have a significant effect on the level of consumer ethnocentrism. The results can be used in many fields (sociology, psychology, marketing); both theories and practice.

*Keywords:* consumer ethnocentrism, socio-demographic factors, Worldmindedness, Patriotism

## **1 INTRODUCTION**

Each of us is born and developed in different communities that then form subgroups. As an individual in a given group is born and developed, they consider it for their own. Thus, they put it on a pedestal that serves as a basis for evaluating other groups and communities. Ethnocentrism takes different forms based on a subject that is characteristic by subjects in the group. The consumer ethnocentrism is our focus in terms of subject.

Ethnocentrism is an important factor in consumer behaviour. It is necessary to realize that we live in a time when the process of globalization is on its rise. There are opinions that globalization is gradually eliminating local traditions and differences in regions that result in the creation of a homogeneous world culture. Slovakia is a smaller country but has a deep tradition. In favour of the slow traditions weakening, the fact that Slovakia is the "heart of Europe" causes different cultures to meet regularly and interact with each other. This is one of reasons why is appropriate a thorough and long-term review of the topic of work in Slovakia.

Consumer ethnocentrism is most often seen as a barrier to consumer decision-making. Since the ethnocentric consumer blindly prefers the products of his national group to support the domestic economy. Consumer ethnocentrism is therefore based on internal consumer beliefs. Several factors influence the degree of consumer ethnocentrism.

The main aim of the article is to measure consumer ethnocentrism in Slovakia and to investigate which factor of the consumer ethnocentrism is significant. The examined factors were chosen based on professional foreign studies. In the article, we focus on exploring socio-demographic factors (age, gender, income and level of education) but also on less researched factors such as Worldmindedness, Patriotism and National Economy Assessment that are separate science concepts.

## 2 THEORETICAL BACKGROUND AND DEVELOPMENT OF HYPOTHESIS

For the first time the concept of ethnocentrism was presented by American psychologist William Graham Sumner in his book named "Folkways: A Study of the Sociological Importance of Usages, Manners, Customs, Mores, and Morals". Ethnocentrism in general was defined as "the technical name for this view of things in which one's own group is the centre of everything, and all others are scaled and rated with reference to it. Folkways correspond to it to cover both the inner and the outer relation. Each group nourishes its own pride and vanity, boasts itself superior, exalts its own divinities, and looks with contempt on outsiders. Each group thinks its own folkways the only right ones, and if it observes that other groups have other folkways, these excite its' scorn. For our present purpose the most important fact is that ethnocentrism leads a people to exaggerate and intensify everything in their own folkways which is peculiar, and which differentiates them from others." (Sumner, 1906; Sumner, 2007)

Consumer ethnocentrism has been derived from this general concept. Shimp and Sharma (1987) developed definition of consumer ethnocentrism as "the beliefs held by American consumers about the appropriateness, indeed morality, of purchasing foreign made products. From the perspective of ethnocentric consumers, purchasing imported products is wrong because, in their minds, it hurts the domestic economy, causes loss of jobs, and is plainly unpatriotic; products from other countries (i.e., out-groups) are objects of contempt to highly ethnocentric consumers" and proposed Consumer Ethnocentrism Scale (CETSCALE) included 17 items. CETSCALE is the most popular scale used in marketing with context of consumer ethnocentrism.

Ethnocentrism has been a fertile and popular concept across a variety of disciplines including marketing, philosophy, sociology, psychology, political science and others. Marketers should apply information about level of consumer ethnocentrism in positioning their products and targeting the customer segments. A high level of consumer ethnocentrism gives the marketer a valuable tool when creating campaigns. For example, "Buy domestic" campaigns have a higher chance of success if the target market is ethnocentric.

*RQ1: What is the level of consumer ethnocentrism in Slovakia?*

Already the creators of the consumer ethnocentrism phenomenon, Shimp and Sharma (1987) observed differences in ethnocentrism rates based on age. They concluded that younger consumers are less ethnocentric than older. Caruana (1996) and Klein and Ettensoe (1999), who have reached the same results based on empirical research, agree with this statement. Newer studies such as Grundey and Bakowska (2008) and Čvirik (2018) have also shown a tendency for older consumers to be more ethnocentric. However, some authors consider this conclusion to be ambiguous. Sharma et al. (1995) and Festervand et al. (1985) did not demonstrate a significant statistical link between age and ethnocentrism. Based on qualitative research, Schooler (1971) concluded that age has a negative relationship to ethnocentrism. Segment age intervals are different for different authors, often undefined, which may result in differences in results.

*H1: Older consumers are more consumer ethnocentric than younger consumers.*

Gender has been studied by many experts as consumer ethnocentrism factor. Sharma et al. (1995) concluded that women are more ethnocentric than men. Bruning (1997) and Čvirik (2018) came with the same. Caruana (1996) and Balabanis et al. (2001), based on quantitative research, have not shown a link between gender and ethnocentrism. A study by Bannister and Saufers (1978), based on qualitative research, shows that men in Britain achieve higher ethnocentrism than women.

*H2: Women are more consumer ethnocentric than men.*

The study of the difference in the formal education level acquired and the consumer ethnocentrism level has been studied in several studies. Sharma et al. (1995) on a sample of US consumers concluded that consumers with higher education are less ethnocentric. Similar conclusions came from Kaynak - Kara (2002). Balabanis et al. (2001); they did not demonstrate the link of a given factor to consumer ethnocentrism.

*H3: Consumers with lower level of education are more ethnocentric than consumers with the one of the higher level.*

Sharma et al. (1995) and Bruning (1997) concluded that the level of income is one of the factors affecting ethnocentric behaviour when examining the amount of individual income and their degree of consumer ethnocentrism. In their research, they found a negative correlation between these variables. They justify that the higher the income a consumer has, the more they can travel and buy foreign products. Han (1988) did not find any income effects. Tan and Farley (1987) noted a positive relationship between income and consumer ethnocentrism.

*H4: Lower-income consumers tend to be more consumer ethnocentric than higher-income consumers.*

The relationship between patriotism and ethnocentrism has been explored by the creator of the concept of ethnocentrism - Sumner (1906). Sumner (1906) described patriotism as an in-group defence against out-group. The influence of patriotic behaviour on consumer ethnocentrism was examined by several experts who considered it for one of the key factors. Sharma et al. (1995) defines patriotism as a "manifestation of love for the home country". At the same time, the team of authors concluded, based on their research, that patriotism has a positive effect on consumer ethnocentrism. With the same results also came Han (1988) and Klein and Ettensoe (1999).

*H5: Consumers with a higher rate of patriotism achieve higher levels of consumer ethnocentrism than consumers with lower rates of patriotism.*

Based on quantitative research, Klein and Ettensoe (1999) have shown that if consumers are convinced that the national economy is improving, they are achieving lower ethnocentrism, and vice versa; if the state of the domestic economy is bad, the rate of ethnocentrism is increasing for the situation.

*H6: Consumers who are convinced that the national economy is improving achieve lower levels of consumer ethnocentrism.*

The Worldmindedness is a technical term understood as "state of mind - in which consumers use humankind as the primary reference group instead of respective nationalities." (Rawwas et al., 1996). Rawwas et al. (1996) investigated a negative relationship between consumer ethnocentrism and the Worldmindedness.

*H7: Less worldmindedness consumers are more ethnocentric than consumers with more score on worldmindedness scale.*

### **3 METHODOLOGY**

The main aim of the paper is to investigate the influence of selected factors in Slovakia. The article is supported by a primary survey. We used the non-probability sample - Convenience sample. Basic population was defined as Slovak consumers (consumer with Slovak nationality) older than 15 years. A sample of 300 respondents was employed in the research to collect the empirical data, consisting of 156 (52%) female respondents and 144 (48%) male respondents

and this also perfectly corresponds with the proportion of women and men in the Slovak population.

The questionnaire consisted of four parts. In the first part we aimed to measure the consumer ethnocentrism in the sample based on the CETSCALE (Shimp and Sharma, 1987). According to the research by Čvirik (2018) conducted in Slovakia, we concluded that the standard version of CETSCALE (Shimp and Sharma 1987) is not appropriate and needs to be updated. Therefore, we use a 9-item scale that, based on the research of Čvirik (2018), achieves high validity and reliability. To indicate the strength of the agreement, we employed a five-point Likert-type scale (1 = strongly disagree, 5 = strongly agree). Based on the above, it can be stated that CETSCALE values will be in the range of 9 - 45 points, with 9 representing low consumer ethnocentrism and 45 representing strong consumer ethnocentrism. The modified CETSCALE used by us achieved a high level of reliability (Cronbach's alpha = 0.865). The modified CETSCALE as a tool for measuring ethnocentrism was used in the primary questionnaire survey. Mean scores, standard deviations and Cronbach's alphas for the items of modified CETSCALE are presented in the Tab. 1.

Tab. 1 – Modified CETSCALE. Source: own research

<b>Modified CETSCALE items*</b>	<b>Mean scores</b>	<b>Standard deviations</b>	<b>Cronbach alpha**</b>
1. Only those products that are unavailable in the Slovak Republic should be imported.	3,34	1,43	0,864
2. Slovak products, first, last, and foremost.	3,00	1,48	0,862
3. Purchasing foreign-made products is un-Slovakian.	2,33	1,11	0,857
4. It is not right to purchase foreign products, because it puts Slovaks out of jobs.	2,79	1,22	0,851
5. A real Slovak should always buy Slovak - made products.	2,56	1,34	0,855
6. We should purchase products manufactured in Slovak Republic instead of letting other countries get rich off us.	3,27	1,60	0,845
7. Slovaks should not buy foreign products, because this hurts Slovaks business and causes unemployment.	2,81	1,36	0,838
8. We should buy from foreign countries only those products that we cannot obtain within our own country.	2,72	1,44	0,852
9. Slovak consumers who purchase products made in other countries are responsible for putting their fellow Slovaks out of work.	2,49	1,14	0,850

Notes: \*Based on Shimp and Sharma 1987 and Čvirik 2018. \*\*Overall Alpha = 0.865.

The second part of the questionnaire was focused on measuring of the Worldmindedness, Patriotism and evaluation of the national economy of Slovakia level. The Worldmindedness can be measured by the Worldmindedness scale created and tested by Sampson and Smith (1957). The scale consists of 32 statements. The possibility of measuring patriotism was first examined and tested by Adorno by P-Scale, respectively. Pseudo-patriotism scale with contains 14 statements. (Adorno et al. 1950). To indicate the strength of the agreement, we employed a five-point Likert-type scale (1 = strongly disagree, 5 = strongly agree). We used only selected items from Worldmindedness scale (selected statements = 2, 4, 8, 11, 20, 27, 28, 30, 32) and Pseudo-patriotism scale (selected statements = 1, 2, 3, 4, 9, 11, 14) due to length of questionnaire. Mean scores, standard deviations and Cronbach's alphas for the items of Worldmindedness scale, Pseudo-patriotism scale and Rating Scale for national economy are presented in the Tab. 2.

The third part of the questionnaire deals with selected characteristics of respondents: age, gender, education and income.

Tab. 2 – Modified scales. Source: own research

	Mean scores	Standard deviations	Cronbach alpha
<b>Modified Worldmindedness scale*</b>			
Immigrants should not be permitted to come into our country if they compete with our own workers.	3,977	1,681	0,657
All prices for exported food and manufactured goods should be set by an international trade committee.	2,657	1,53	0,729
We should be willing to fight for our country without questioning whether it is right or wrong.	2,117	0,938	0,695
We ought to have a world government to guarantee the welfare of all nations irrespective of the rights of any one.	3,29	1,331	0,716
If necessary, we ought to be willing to lower our standard of living to cooperate with other countries in getting an equal standard for every person in the world.	2,377	1,312	0,734
All national governments ought to be abolished and replaced by one central world government.	2,897	1,476	0,747
It would not be wise for us to agree that working conditions in all countries should be subject to international control.	2,857	1,635	0,678
It would be a good idea if all the races were to intermarry until there was only one race in the world.	3,14	1,51	0,723
War should never be justifiable even if it is the only way to protect our national rights and honour.	4,24	1,236	0,815
<b>Modified Pseudo-patriotism scale**</b>			
Patriotism and loyalty to the country are the first and most important requirements of a good citizen.	3,38	1,491	0,791
Some forms of military training, obedience, and discipline such as drill, marching, and simple commands should be made a part of the elementary school educational program.	1,793	0,956	0,884
Under our judicial system, the punishment awarded to those who disobey the law of the land is very light.	3,23	1,478	0,793
Hungary can never advance to the level of Slovakia due mainly to the innate laziness, lack of ambition, and general backwardness of the Hungary.	4,457	1,116	0,832
Only natural Slovakian citizens should have the right to hold office under the Constitution of Slovakia.	3,643	1,372	0,792
When international matches are played in Slovakia, the audience should not be allowed to wave flags of other countries.	3,267	1,582	0,784
Foreign companies should not be allowed in the Slovakian market because in one way or the other they are robbing our country.	4,087	1,358	0,808
<b>Rating Scale for national economy***</b>			
I believe that the Slovak national economy is improving every year.	2,737	1,524	0,791
The economic situation in Slovakia is good.	2,997	1,353	0,784
The national economy in Slovakia is stable.	3,29	1,492	0,689

Notes: \*Based on Sampson and Smith (1957), Overall Alpha=0,754; \*\*Based on Adorno et al. (1950), Overall Alpha=0,832; \*\*\*Overall Alpha=0,787.

## 4 RESULTS AND DISCUSSION

The main aim of the article is to measure consumer ethnocentrism in Slovakia and to investigate possible factors of consumer ethnocentrism. Based on the literature, we have created hypotheses that aim to verify the validity of consumer ethnocentrism factors in Slovakia.

*RQ1: What is the level of consumer ethnocentrism in Slovakia?*



The average of consumer ethnocentrism in Slovakia investigated accounted for 25.31 points, which is below the average in scale (scale average - 27; <9,45> scale). The average calculation error is 0.489 points. The lowest measured rate of consumer ethnocentrism has reached 9 points, which is the smallest possible measurable value. The modus represents a value of 32 points and a median of 26. Overall, we measure the measured ethnocentrism as below average.

To verify the hypotheses and one-way ANOVA tests for socio-demographic variables (age, gender, income and education). The results of the ANOVA test for socio-demographic factors (H1-H4) were recorded by the Tab. 3.

Tab. 3 – Hypothesis Evaluation Results (ANOVA). Source: own research

	<b>F - value</b>	<b>F - crit.</b>	<b>F-F crit.</b>	<b>alpha</b>	<b>p-value</b>	<b>alpha - p-value</b>
<b>H1</b>	68.464	3.026	F > F crit.	0.05	3.53E-25	Alfa > P-value
<b>H2</b>	80.463	3.873	F > F crit.	0.05	3.37E-17	Alfa > P-value
<b>H3</b>	4.502	3.026	F > F crit.	0.05	0.012	Alfa > P-value
<b>H4</b>	16.010	3.873	F > F crit.	0.05	7.95E-05	Alfa > P-value

The Hypothesis H1 suggested that older consumers are more consumer ethnocentric than younger ones. Respondents were divided into three groups (under 25, 25-49 and over 49). The average measured value of consumer ethnocentrism in respondents under 25 was 18.88 points. The group of respondents from 25 to 49 years was on average 27.20 points. The highest average value was measured for respondents who were 55 and over - 30.60. Based on the averages of individual groups, it can be stated that there are differences and older groups of respondents have always achieved a higher average value of consumer ethnocentrism. The results in Tab. 3 indicate a significant of age on consumers' ethnocentric tendencies.

The Hypothesis H2 stated that women are more consumer ethnocentric than men. The average measured value of consumer ethnocentrism among women was 29.37 and the average value for men was 21.57 points. Based on the above results in Tab. 3 (F > F crit.). The hypothesis confirmation is also supported by the fact that Alpha > P-value. In this way, it can be rejected that it was just a noise. Therefore, the hypothesis H2 is supported.

The Hypothesis H3 stated that: consumers with lower level of education are more ethnocentric than consumers with higher level of education. Respondents were divided into three groups (attained basic education, attained secondary education and attained university education). Respondents with completed primary education achieved an average consumer ethnocentrism rate of 27.03 points and respondents with secondary education achieved an average consumer ethnocentrism of 25.54 points. Consumers with higher education achieved the lowest level of consumer ethnocentrism (23.05 points). Based on results in Tab. 3 (F > F- crit.), Hypothesis 3 can be confirmed. Confirmation of the hypothesis is also supported by the fact that Alpha > P-value.

The Hypothesis H4 suggested that lower-income consumers tend to be more consumer ethnocentric than higher-income consumers. We divided consumers into two groups. The first group was consumers with an average gross income of up to 1023€, and the second group was consumers with a gross wage of 1023 € or more. The reason for choosing 1023 € is that, based on the Statistical Office of Slovakia, this amount represents the average monthly earnings of Slovaks. (StatDAT, 2019) Respondents up to 1023€ earned an average of 24.01 points for consumer ethnocentrism, and consumers with an income over 1023€ achieved an average consumer ethnocentrism rate of 28.11 points. Based on the results, it can be stated that the hypothesis was not confirmed. The results in Tab. 3 suggest that income is a significant factor in consumer ethnocentrism. However, the hypothesis cannot be confirmed, as it clearly shows

that consumers with higher incomes are more consumer ethnocentric than consumers with lower incomes.

We used the regression analysis to examine factors such as the Worldmindedness (based on Worldmindedness scale) Patriotism (based on Pseudo-patriotism scale) and assessment of the national economy (based on the scale created - Rating Scale for National Economy). The results of the regression analysis for Hypothesis H5-H7 were recorded by the Tab. 4. The regression and correlation analysis output consist of three parts; the first part is the output of the correlation analysis, the second one is the ANOVA output, where we test the suitability of the model used. In ANOVA, we test a zero hypothesis that claims the model we chose to be explaining dependence (in our case linear regression line) is not appropriate (the alternative hypothesis argues the opposite). The F test is used to evaluate this claim.

Tab. 4 – Regression analysis. Source: own research

		Patriotism	Rating for National Economy	Worldmindedness
<b>Regression Statistics</b>	<b>Multiple R</b>	0.844958	0.887955	0.602975
	<b>R Square</b>	0.712995	0.788464	0.363579
	<b>Standard Error</b>	4.533815	3.89887	6.762675
<b>ANOVA</b>	<b>Alpha</b>	0.05	0.05	0.05
	<b>P-value</b>	0.048	1.5E-157	8.16E-112
	<b>Significance F</b>	5.57E-83	1.6E-102	4.36E-31
<b>Regression function</b>		positive	negative	negative

*H5: Consumers with a higher rate of patriotism achieve higher levels of consumer ethnocentrism than consumers with lower rates of patriotism.*

The average rate of patriotism was 26.99 points what is above average (scale average - 24; <8,40> scale interval). Results from Tab. 4 indicate a strong link between consumer ethnocentrism and patriotism. The results indicate positive and significant effect of patriotism on consumer ethnocentrism. Hypothesis H5 is therefore supported.

*H6: Consumers who are convinced that the national economy is improving achieve lower levels of consumer ethnocentrism.*

The mean of Rating Scale for National Economy was 9.02 what is average value (scale average - 9; <3,15> scale interval). The findings (Tab. 4) support H6 and document that consumers who are convicted that the nation economy is improving achieve lower levels of consumer ethnocentrism. The results indicate negative and significant effect of rate for national economy on consumer ethnocentrism.

*H7: Less worldmindedness consumers are more ethnocentric than consumers with more score on worldmindedness scale.*

The average rate of Worldmindedness was 27.55 points, which is average rate (scale average - 27; <9.45> scale interval). Results from Tab. 4 indicate a strong link between consumer ethnocentrism and Worldmindedness. The results indicate negative and significant effect of patriotism on consumer ethnocentrism. Hypothesis H7 is therefore supported.

## 5 CONCLUSION

The main aim of the article is to measure consumer ethnocentrism in Slovakia and to investigate possible factors of consumer ethnocentrism. The article is written on the bases of a primary research conducted on a sample of 300 Slovak consumers.

The results of the primary survey indicate that the rate of consumer ethnocentrism is below average. Based on Cronbach's alpha, it can be concluded that 9-item CETSCALE is suitable for the region of Slovakia. The results indicate that socio-demographic factors have a significant impact on consumer ethnocentrism. Age is a significant positive factor, and thus older consumers are more consumer ethnocentric than young consumers. Gender is also an important factor and, based on the results of the survey, women are more ethnocentric than men. The level of education seems to be another important factor that has been examined at the three levels of education. In general, consumers with lower education are more consumer ethnocentricities. An interesting situation was found in the examination of the income factor. Consumer income has been shown to be a significant factor, but not in a positive direction, as the foreign literature suggests but in the negative. Thus, it can be stated that low-income consumers are less consumer ethnocentric than consumers with higher income. Strong regression has been found in exploring the concepts of Worldmindedness and Patriotism, suggesting that these concepts are closely related. The Worldmindedness has a negative effect on the level of consumer ethnocentrism, but Patriotism acts in a positive way. The impact of the assessment (attitude) on the national economy has been shown to be a factor affecting the level of consumer ethnocentrism in the sense that consumers who believe that their domestic economy has grown to a lower level of consumer ethnocentrism.

Although, research has some limits. The greatest limits can be considered only by examining selected factors. In the future, it would be appropriate to explore a larger number of factors. Another limit of research is the modified CETSCALE, modified the Worldmindedness scale and modified Pseudo-patriotism scale, which has a positive effect on the accuracy of the results, but negatively in the context of comparing research with others. In general, these findings can be used in marketing, but also can be used in many fields (sociology, psychology...); both theories and practice.

## References

- Adorno, T. W., Frenkel-Brunswik, E., Levinson, D. J., & Sanford, N. (1950). *The Authoritarian Personality*. New York: Harper & Row Publishers.
- Balabanis, G., Diamantopoulos, A., Mueller, R. D., & Melewar, T. C. (2001). The impact of nationalism, patriotism and internationalism on consumer ethnocentric tendencies. *Journal of International Business Studies*, 32(1), 157-175. doi: 10.1057/palgrave.jibs.8490943
- Bannister, J. P., & Saunders, J. A. (1978). UK consumers' attitudes towards imports: the measurement of national stereotype image. *European Journal of Marketing*, 12(8), 562-570. doi: 10.1108/EUM0000000004982
- Bruning, E. (1997). Country of origin, national loyalty and product choice: case of international air travel. *International Marketing Review*, 14(1), 59-74. doi: 10.1108/02651339710159215
- Caruana, A. (1996). The effects of dogmatism and social class variables on consumer ethnocentrism in Malta. *Marketing Intelligence & Planning*, 14(4), 39-44. doi: 10.1108/02634509610121569
- Čvirik, M. (2018). Spotrebiteľský etnocentrizmus v generačnom kontexte. *Studia commercialia Bratislavensia*, 11(39), 5-14. Retrieved from [https://of.euba.sk/www\\_write/files/veda-vyskum/scb/vydane-cisla/2018-01/scb0118-cvirik.pdf](https://of.euba.sk/www_write/files/veda-vyskum/scb/vydane-cisla/2018-01/scb0118-cvirik.pdf)

- Festervand, T. A. et al. (1985). Consumer perceptions of imports: an update and extension. *Akron Business and Economic Review*, 16(1), 31-36.
- Grundey, D., & Bakowska, S. (2008). Consumer Economics: Brand Awareness among Polish Consumers. *Transformations in Business & Economics*, 7(2), 186-199. Retrieved from <http://search.ebscohost.com/login.aspx?direct=true&db=e5h&AN=35708634>
- Han, C. M. (1988). The role of consumer patriotism in the choice of domestic versus foreign products. *Journal of Advertising Research*, 28(1), 25-32.
- Klein, J. G., & Ettensoe, R. (1999). Consumer animosity and consumer ethnocentrism: an analysis of unique antecedents. *Journal of International Consumer Marketing*, 11(4), 5-24. doi: 10.1300/J046v11n04\_02
- Rawwas, M., Rajendran, K., & Wuehrer, G. (1996). The influence of worldmindedness and nationalism on consumer evaluation of domestic and foreign products. *International Marketing Review*, 13(2), 20-38. doi: 10.1108/02651339610115746
- Sampson, D., & Smith, H. P. (1957). A scale to measure world-minded attitudes. *Journal of Social Psychology*, 45(1), 99-106. doi: 10.1080/00224545.1957.9714290
- Sharma, S., Shimp, T. A., & Shin, J. (1995). Consumer ethnocentrism: a test of antecedents and moderators. *Journal of the Academy of Marketing Science*, 23(1), 26-37. doi: 10.1177/0092070395231004
- Shimp, T. A., & Sharma, S. (1987). Consumer Ethnocentrism: Construction and Validation of the CETSCALE. *Journal of Marketing Research*, 24(3), 280-289. doi: 10.1177/002224378702400304
- Schooler, R. (1971). Bias phenomena attendant to the marketing of foreign goods in the US. *Journal of International Business Studies*, 2(1), 71-81. Retrieved from <https://www.jstor.org/stable/154727>
- Statdat. (2019). *Priemerná mesačná mzda v hospodárstve SR*. Retrieved from <http://bit.ly/38l5XiI>
- Sumner, W. G. (1906). *Folkway: A Study of the Sociological Importance of Usages, Manners, Customs, Mores, and Morals*. Boston: Ginn and Company.
- Sumner, W. G. (2007). *Folkway: A Study of the Sociological Importance of Usages, Manners, Customs, Mores, and Morals*. New York: Cosimo Classics.
- Tan, C. T., & Farley, J. U. (1987). The impact of cultural patterns on cognition and intention in Singapore. *Journal of Consumer Research*, 13(4), 540-544. doi: 10.1086/209087

## Contact information

### Ing. Marián Čvirik

University of Economics in Bratislava, Faculty of Commerce  
 Dolnozemskácesta 1, 852 35 Bratislava, Slovak Republic  
 E-mail: marian.cvirik@euba.sk  
 ORCID: 0000-0003-4701-1543

doi: 10.7441/dokbat.2019.020

# STRUCTURAL EVALUATION OF ATTITUDES TOWARDS RURAL TOURISM: A PROPOSED STUDY

*Sandeep Kumar Dey, Zuzana Tučková*

## **Abstract**

People are visiting rural places of interest like never before; this has garnered much interest in tourism academia. With scholastic advances in the field of sustainable tourism development over the last 4 decades, it is important that growth should be managed and measured through the paradigms of sustainable tourism development (Institutional, Economic and Environmental), that becomes the essence of this conceptual paper wherein an attempt is made to predict the attitudes of tourists towards rural destinations in order to further comprehend the economic dynamics of sustainable tourism development and its implication on rural destinations. The study aims to utilise existing epistemological aspects pertaining to the investigation of tourist behaviour, the authors have attempted to adapt the Theory of Planned Behaviour and use one of its verticals that is ‘attitude’ to study the population.

*Keywords: rural economics, sustainable tourism, tourist behaviour*

## **1 INTRODUCTION TO PROBLEM STATEMENT AND PURPOSE OF STUDY**

The previous two decades have been testimony to the robust changes and socioeconomic transfigurations all over the world. These transformations impacted and bore a pressure to the isolated, peripheral and rural regions of the world. According to Pattanaro (2005) and Gannon (1993) changes to the conventional economic and social compositions of rural communities resulted in depreciating farmland output levels compounded with inflated rates of unemployment leading to a mass withdrawal of productive and operational factors of agriculture. This has directly and indirectly caused an imbalance in the socioeconomic fabric of the rural areas.

It appears to be evident from various studies Kim (2001) and Hall (2009) & Park (2010), the significance of rural areas for socioeconomic development and regeneration along with the variegation of their economic foundation in order to address the changes that the modern worlds bring us. The evolution of rural tourism has impacted and changed the paradigm on the tourist demand-behaviour continuum, touristic activities based in rural areas offer the possibilities for alternative, niche and authentic avenues of tourist experiences, appealing to the “upcoming” generation of tourists, additionally Page (1997) maintains that there is a growing demand for tourism and recreational activities in the rural areas that is dissimilar from the traditional resorts and mass tourism reception regions.

Hall (2000) studied that the primary motivations behind this project is based on the fact that there has been a dramatic growth in the tourism and travel industry, conventional mechanisms of tourism development concentrated around coastal, mountainous, urban and cultural settings have yielded extensive benefits to the economy, environment and society of the local community.

However, certain regions in spite of containing a substantial quantum of tourism inventory in terms of built and natural environments are lagging behind and remain under-explored and unexploited in terms of rural based tourism activities, this increments the necessity of such

studies. Although tourist activities centring on rural areas is considered to be a relatively new attribute of tourism supply, in recent years there has been a spurt in demand for travel experiences in small villages and the countryside in various rural territories around the world, as observed by Carter (1999).

**The research aims to empirically investigate the following:**

- a) The attitudes of leisure tourists towards visitation of rural areas

## **2 LITERATURE REVIEW**

Lane (1994) explains that in the most traditional view, agriculture and forestry formed the crux of country life. This proved to be the major source of income within rural economy and indirectly had a powerful impact on conventional power equations and life styles.

Roberts (2001) observes that there exists no standard definition of the term ‘rural’ and additionally the various definitions that do exist vary not only in scale but also in philosophy, while many countries utilize specific criteria to define rurality, there is no universal agreement on the critical threshold which demarcates between urban and rural populations.

Lane (1993) maintains that although appears to be simple to define rural tourism as any activity that takes place in the countryside, it fails to consist the complexity of the activities and various forms and interpretations established in other countries, as well as the number of exponents participating in the overall framework of rural tourism.

Further ahead, Lane (1994a) notes that it is a challenge to define rural tourism as there are no theoretical bases from nodal organizations like United Nations World Tourism Organizations (UNWTO) nor the Economic Cooperation and Development (OECD) in this regard.

Opperman (1996) through his findings has given a parallel dimension to the understanding of rural tourism wherein the author notes that, rural tourism lacks a comprehensive body of knowledge and theoretical framework, he further adds that the absence of standing theory maybe a result of the following:

- a) Definitional challenges pertaining to the constitution of rural tourism
- b) Mirroring Butler (1998) research on the topic, he argued that lack of data sources on micro level rural businesses makes rural tourism relatively less obvious and signals more meticulous efforts from researchers in the procurement of data.

The need to distinguish between rural tourism from various forms of tourism exists, to the extent that the fine line between rural tourism and urban tourism is difficult to define due to the mutual rural connotation(s). Bramwell (1994) understands that “the social representations of rural areas by the media and the perceptions of individuals for the countryside certainly create a demand for these spaces and shape consequently the distinctive form of rural tourism”.

Eminent authors like Gannon (1994) have held the fact that rural tourism consist a range of activities services and amenities provided by the farming community to attract tourists to their areas in order to generate extra income for their business.

The Commission of the European Communities (1987) describes RT as “rural tourism is a vast concept covering other services besides accommodation such as events, festivities, outdoor recreation, production and sale of handicrafts and agricultural products”.

At this juncture, Murdoch (1993) precautions researches that not every aspect of tourism in rural conditions can be considered as ‘rural’ in the most orthodox sense of understanding.

## **2.1 Retrospection the development of rural tourism as a field of study**

Interest in recreational activities at rural locations developed at the end of the 18th century as a form of ‘stressbuster’ of the rising working class. As Urry (1990) and Kelly (2015) put it, the rural settings became the “gaze” of the emerging genre of tourists and influenced the creativity of the intelligentsia. Sharply (1996) concluded that development in rural tourism is due to technological advancements, availability of leisure time and the increment in disposal income.

Harrison (1991), Deer (2010) and Ho (2005) highlight the fact that the spurt in demand took place at the end of the second world war, the primary factor remained the increase in car ownership gave an impetus to travel and tourism to rural areas. Knudson (1985) in his study devised the fact that number of tourists engaged in the scope of activities and types of rural recreation avenues that has continued to increase significantly.

## **3 SUMMARISING SUSTAINABLE TOURISM**

Swarbrooke (2010) in his work titled “Sustainable tourism management” highlights the fact that sustainable tourism is a form of tourism that meets the needs of the tourists, the tourism industry and host communities today without compromising the ability of future generations to meet their own needs.

### **3.1 Principles of Sustainable Tourism Management**

Adapting from Bramwell (1996) the following are:

- a) The approach sees policy, planning and management as appropriate, and indeed essential responses to the problems of natural and human resource misuse in tourism;
- b) The approach is generally not anti-growth, but it emphasizes that there are limitations to growth and that tourism must be managed within these limits;
- c) Long term rather than short term thinking is necessary;
- d) The concerns of sustainable tourism management are not solely environmental, but are also economic, social, cultural, political and managerial;
- e) The approach emphasizes the importance of satisfying human needs and aspirations, which entails a prominent concern for equity and fairness;
- f) All stakeholders need to be consulted and empowered in tourism decision-making, and they also need to be informed about sustainable development issues;
- g) While sustainable development should be a goal for all policies and actions, putting ideas of sustainable tourism into practice means recognizing that in reality there are often limits to what will be achieved in the short and medium term;
- h) An understanding of how market economies operate of the cultures and management procedures of private sector businesses and of public and voluntary sector organizations and of the values and attitudes of the public is necessary in order to turn good intentions into practical measures;
- i) There are frequently conflicts of interest over the use of resources, which means that in practice trade-off and compromises maybe necessary;
- j) The balancing of costs and benefits in decisions on different courses of action must extend to considering how much different individuals and groups will gain and lose.

### 3.2 Conceptualizing the inter-relation between Sustainability and Rural Tourism

Swarbrooke (2001) conceptualized the framework on sustainable tourism and attempted to study its attributes and thus the following figure emerged:

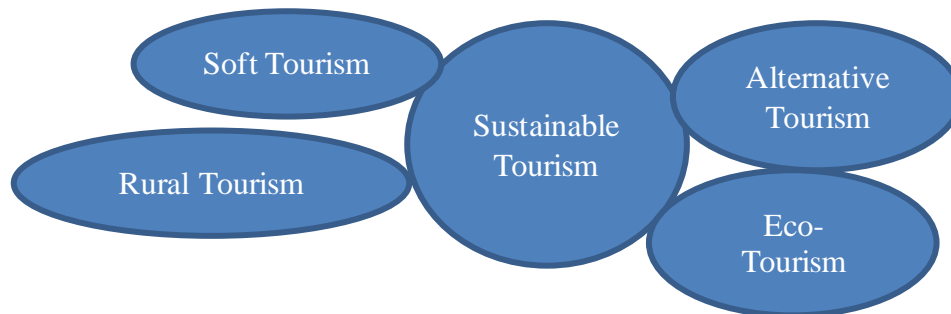

Fig. 1 – Conceptual Framework of Sustainable Tourism. Source: Swarbrooke (2001)

## 4 THE THEORY OF PLANNED BEHAVIOUR

Icek Ajzen (1980) promulgated this theory, as an extension of the already existing Theory of Proposed Action which was propounded by him and Driver.

The notion of the behavioural intention; a person's intention of performing a given behaviour is the best predictor of whether or not the person will actually perform the behaviour. It is based on the premise that the best predictor of an actual behaviour is the behaviour a person actually intends to do.

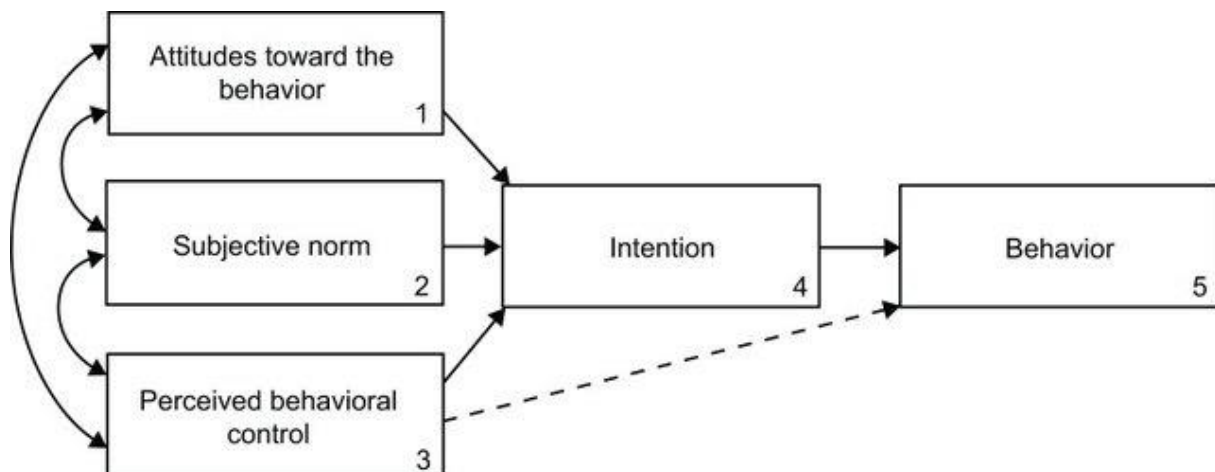

Fig. 2 – Planned behaviour. Source: Ajzen (1980)

Quintal (2010) have used the model to understand risk and uncertainty among tourists from Australia and South Korea wherein the model helped the authors to understand the perceived risk did have a positive effect on the behavior intentions of the tourists. Jalilvand (2012) in their study have employed the model to understand the fact that electronic WOM have a positive impact on the attitudes of people visiting a particular destination in Iran.

Lam (2004) were moderately successful in predicting the behavioral intentions of Chinese mainland travelers to Hong Kong. Chen (2014) tested the model to predict consumer's intention to visit green hotels in Taiwan and the results conveyed that indeed, potential consumer's



environmental concern do exert a positive influence on their attitudes towards green accommodation options.

Han (2017) in their study, have extended the TPB model to inculcate subjective norms and link the same with past behavior patterns to predict potential consumer behavior towards bicycle tourism in China. Horng, (2013b) developed an extended model based on the TPB to examine behavior outputs against lifestyle. The study observed different consumers portray different behavioral outputs based on their lifestyles.

## 5 ATTITUDES TOWARDS VISITATIONS TO RURAL TOURISM DESTINATIONS – A NOVEL RESEARCH TERRITORY

For the purpose of the proposed research we wish to extract a single vertical of the TPB model that is “Attitude” to contemplate the behavioural dynamics of potential tourists at rural destinations.

We wish to adopt the ABC (Affective, Behavioural and Cognitive) Model for attitude prediction as propounded by Eagly & Chaiken (1998) and extended by Van den Berg (2006), as thorough literature review has revealed that scholastic endeavors towards predicting consumers’ behavior at rural tourism destinations is lacking.

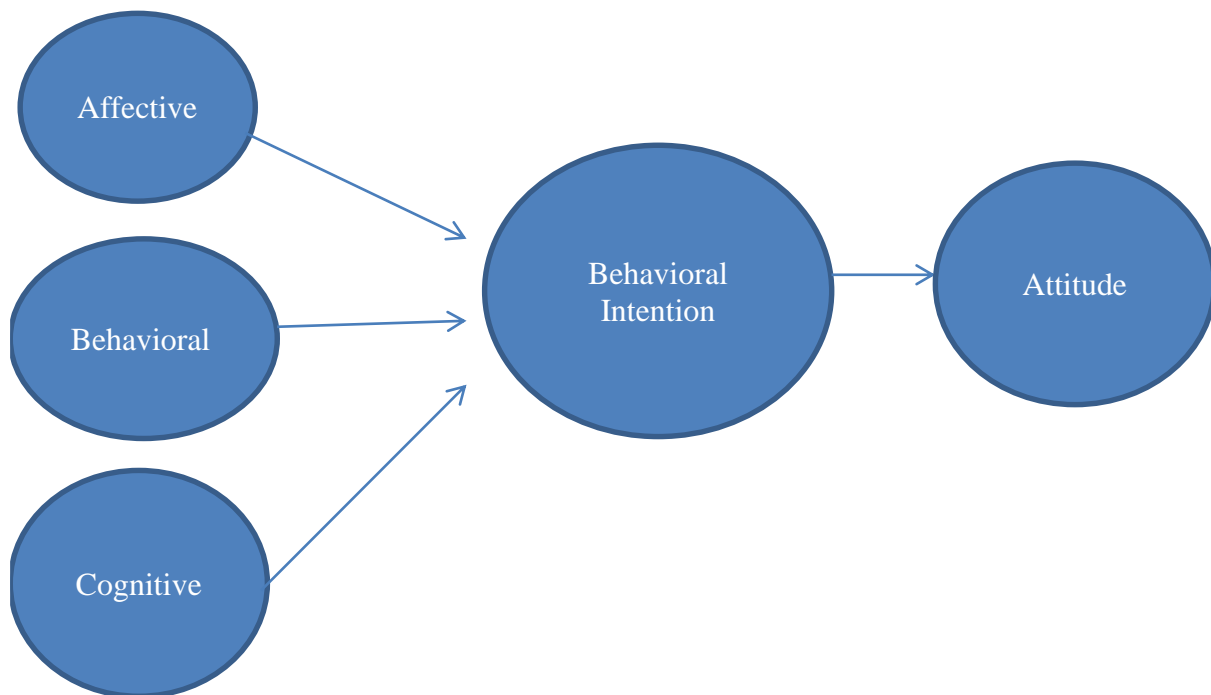

Fig. 3 – ABC Model. Source: Eagly and Chaiken (1998)

### 5.1 Defining the constructs for each variable on the ABC Model

- a) Affective: Russel (1980) demarcated the affective component into two different parts one was hedonistic (exciting/arousing, pleasant, relaxing) and the other was abstention (sleepy, distressing, unpleasant, and gloomy);
- b) Behavioural: Driver (1990) outlined the most important construct in order to study the behavioral aspect of attitude;

- c) Cognitive: Mackenzie (1986) outlined two important constructs that is knowledge objectives or awareness and the second one is reliability and confidence in a product/ service, here the product is the rural destination as also added by Patrick (2011).

## 5.2 Hypothesis to be tested

H<sub>0</sub> = “attitudes don’t influence visitation behaviour to rural areas”

## 6 THEORETICAL MODEL DEVELOPMENT

Post factor loading, the pathway schema ideally should display like below:

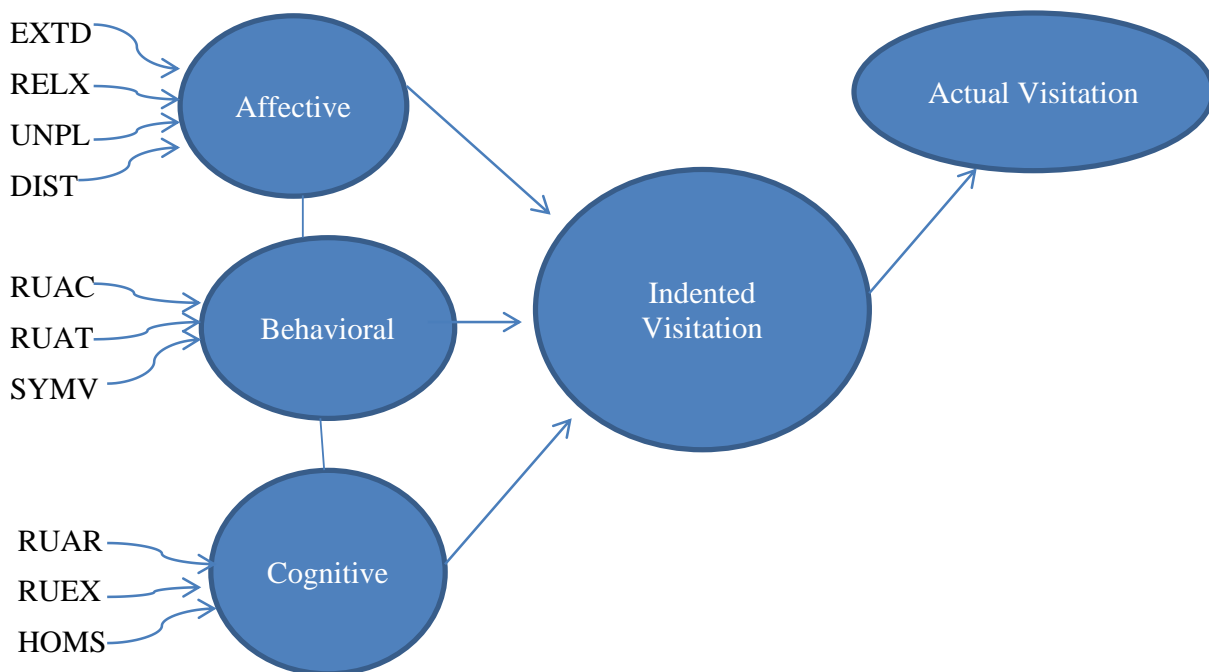

Fig. 4 – Pathway Schema. Source: Eagly and Chaiken (1998)

### 6.1 Rationalising the items on the proposed model

Tab. 1 – Rationalising the items on the proposed model. Source: own research

Variables	Constructs	Source
EXTD	Excitement, arousal, elevation	Apostolopoulou (2015)
RELX	Relaxation and rejuvenation	Devesa (2010)
UNPL	Unpleasant feelings	Gössling (2016)
DIST	Distress	Chang (2013)
RUAC	Rural activities <i>incl.</i> sports	Rid, Ezeuduji & Pröbstl-Haider (2014)
RUAT	Rural attachment <i>incl.</i> interest	Gross & Brown (2006)
SYMV	Perceived symbolic value	Josiam, Smeaton & Clements (1999)
RUAR	Knowledge of rural settings	Greaves & Skinner (2010)
RUEX	Rural experiences	Iorio & Corsale (2010)
HOMS	To gauge reliability attribute, rural homestays and accommodation have been absorbed in contrast against hotels	Acharya & Halpenny (2013)

## 7 PROPOSED RESEARCH METHODOLOGY

For the purpose of the study we shall be utilizing the framework given by Churchill (1979) and Hinkin (1995) of scale development, given below:

<p><b>Step 1: Item Generation / Create Items</b></p> <p><b>Step 2: Content Adequacy Assessment/</b>Test for conceptual consistency of items</p> <p><b>Step 3: Questionnaire Administration/</b> Determine the scale for items, identify sample size (N), administer questionnaire with other established measures</p> <p><b>Step 4: Factor Analysis/</b> Exploratory to reduce the set of items, confirmatory to test the significance of the scale</p> <p><b>Step 5: Internal Consistency Assessment/</b> Determine the convergent and criterion-related validity</p> <p><b>Step 7: Replication/</b>Repeat the scale-testing process with new data set</p>
---

Fig. 5 – Scale development. Source: Churchill (1979) and Hinkin (1995)

### 7.1 Content Adequacy

Nunnally (1978) observed several content assessment methods have been described in the research methods literature. One common method requires respondents to categorize or sort items based on their similarity to construct definitions. This can be conducted using experts in a content domain. In either case, respondents are presented with construct definitions without titles and are asked to match items with a corresponding definition. An acceptable agreement index must be determined prior to administration of the items and definitions. ANOVA method will be used for Content adequacy assessment.

### 7.2 Questionnaire Administration

The Likert's scale would be used to garner responses, as it continues to remain a much-preferred way of response collection in social sciences research reports Hummer (2011). The respondents may choose their agreement/disagreement on a five, seven or even nine point continuum.

### 7.3 Factor Analysis

Will be used to investigate variable relationships, which will help to reduce the number of items to confirm the significance of the scale.

### 7.4 Proposed Sample Size

Contemporary studies have opined that in majority of the studies an N=150 should suffice the project's outcome in exploratory factor analysis, till the time item inter-correlations are substantially robust as advised by Velicer (1988) and Bollen (1989) opines that a minima N=100 be considered for the purpose of Confirmatory Factor Analysis. It is to be noted that, as the number of the sample increments, the potential of attaining statistical importance increases, this might deter the evolution of pragmatism in the results.

### 7.5 Exploratory Factor Analysis

The principal axis is slated to be used for the purpose of study as the principal-constituent methodology of assessment amounts for generic, specific and random error variances, this decision is supported by the likes of eminent authors like Ford (1986) and Rummel (1970). There may be two circumstances here during the EFA stage of the research with the remedy:

- a) Variables are uncorrelated: orthogonal rotation;

- b) If variables are showing correlation: oblique rotation.

## 7.6 Confirmatory Factor Analysis

This is a measure to check the goodness of fit for multi-variate analysis of differing models.

A chi-square analysis will be used to evaluate the goodness-of-fit of the evolved model at the same time, assess the disparity- in- goodness among two other models (Destination Emotional Scale & Sustainable Tourism Measurement Model)

## 7.7 Internal Consistency Assessment

Reliability may be assessed through multiple methodologies, but as Mueller (1986) suggests Cronbach's  $\alpha$  will be utilized to scrutinize the scale's internal consistency. The very reason for me to use the Cronbach's  $\alpha$  is that the paths show us through a Structural Equation Modelling (SEM) procedure how well the items gauge the same constructs. This will be undertaken post the CFA and the EFA when all the redundant items are deleted, the internal reliabilities will be calculated. According to Churchill (1979) "A large coefficient alpha provides an indication of strong item covariance or homogeneity and suggests that the sampling domain has adequately been captured."

## 7.8 Construct Validity

At this stage the evolved scale should be able to gauge content validity and internal consistency reliability. Here we will study about the convergent validity: to check if the other measures can evaluate similar constructs and discriminant validity: to gauge the fact that the constructs don't correlate with dissimilar measures. This has to be done in order to investigate relationships with factors that are theorized to be the end-results of the focal assessment (otherwise known as criterion-related validity)

### Actor Groups

Three major groups have been identified through the implications of the New Ecology Paradigm of Dunlap (2000).

- a) The tourists (not visitors): minimum stay for more than 24 hrs and consumption of local experience (UNWTO);
- b) Local community in rural regions;
- c) Political Administrators: Destination Management Organizations (DMO), Visitor Management Bureaus, Tourism and Travel Authority, Accommodation Operators, Transport Federation.

## 8 EXPECTED CONTRIBUTION

- a) **Sustainability in action:** sustainable tourism development has to be revived in the rural heartlands so that along with development there is growth with equity and that propagation is synchronized with the UNWTO goals, this study will mobilize opinion and measure them in order to establish sustainable growth patterns;
- b) **Prevention of Over tourism:** acclaimed writers like C. Michael Hall have expressively cautioned against mass tourism in the most ecologically delicate of regions, this study will also highlight how sustainable rural tourism can make a difference in the regional map;

- c) **Preservation of the indigenous culture:** the paper will demonstrate how “culture” is a working component of “rural attractiveness” and will offer methods to prevent any form of cultural erosion and loss of the destination genuine;
- d) **Sustainability awareness:** the literature aims to promote the ethos of sustainability among the different stakeholders of the tourism and travel industry of the region;
- e) **A better understanding of the rural tourism industry:** our study wishes to engage the competent tourism authorities in the development of rural tourism infrastructure and organize the tourism supply chain so that holistic destinations maybe developed that may not only provide more opportunities but raise standards of living;
- f) **Rural Circuits Development:** through findings (especially surveys), the paper purports the establishment of a comprehensive network of destinations bearing rural attractiveness at a particular region. Such destinations may be mapped on the basis of relative attractiveness and/or geographical proximity;
- g) **Addition of sustainable inventories:** My paper would also investigate multimodal avenues to incorporate sustainable tourism inventories like wine walks, heritage tours, organic camping, rural adventure tourism activities, country-side cycling in popular tourism itineraries;
- h) **Promote the concept of Culinary, Food and Farm Tourism (CFFT):** this is a contemporary practice in the tourism industry which my paper wishes to put impetus on through the study. As farms and agro based tourism experiences find their roots in rural settings, products like farm familiarization tours, organic farm visits, farm-to-plate concept, local culinary camps etc. will also be studied;
- i) **Advising on demand:** the study will provide an idea of the demographic and psychographic (allocentric, mid-centric and psychocentric) configuration of the incoming tourist to rural regions, which may be utilized to establish marketing strategies for the regions.;
- j) **Women Empowerment:** The study will focus on the emancipation of women through deliberations in the tourism trade;
- k) Competency Building among the local community.

## References

- Abdollahzadeh, G., & Sharifzadeh, A. (2014). Rural Residents Perceptions Toward Tourism Development: A Study from Iran. *International Journal of Tourism Research*, 16(2), 126-136. doi: 10.1002/jtr.1906
- Acharya, B. P., & Halpenny, E. A. (2013). Homestays as an alternative tourism product for sustainable community development: A case study of women-managed tourism product in rural Nepal. *Tourism Planning & Development*, 10(4), 367-387. doi: 10.1080/21568316.2013.779313
- Apostolopoulou, A., & Papadimitriou, D. (2015). The role of destination personality in predicting tourist behaviour: implications for branding mid-sized urban destinations. *Current Issues in Tourism*, 18(12), 1132-1151. doi: 10.1080/13683500.2013.878319
- Aronsson, L. (1994). Sustainable tourism systems: The example of sustainable rural tourism in Sweden. *Journal of Sustainable Tourism*, 2(1-2), 77-92. doi: 10.1080/09669589409510685

- Bollen, K. A., & Long, J. S. (1992). Tests for structural equation models: introduction. *Sociological Methods & Research*, 21(2), 123-131. doi: 10.1080/09669589409510679
- Bramwell, B. (1994). Rural tourism and sustainable rural tourism. *Journal of Sustainable Tourism*, 2(1-2), 1-6. doi: 10.1080/09669589409510679
- Chang, H. H. (2013). Wayfinding strategies and tourist anxiety in unfamiliar destinations. *Tourism Geographies*, 15(3), 529-550. doi: 10.1080/14616688.2012.726270
- Choi, H. C., & Murray, I. (2010). Resident attitudes toward sustainable community tourism. *Journal of Sustainable Tourism*, 18(4), 575-594. doi: 10.1080/09669580903524852
- Christou, P., Farmaki, A., & Evangelou, G. (2018). Nurturing nostalgia? A response from rural tourism stakeholders. *Tourism Management*, 69, 42-51. doi: 10.1016/j.tourman.2018.05.010
- Đenadić, M., Muhi, B., & Jovanović, D. V. (2016). Rural tourism–Serbia’s missed chance. *Economics of Agriculture*, 63(2), 515-529. doi: 10.5937/ekoPolj1602515D
- Devesa, M., Laguna, M., & Palacios, A. (2010). The role of motivation in visitor satisfaction: Empirical evidence in rural tourism. *Tourism Management*, 31(4), 547-552. doi: 10.1016/j.tourman.2009.06.006
- Dunlap, R. E., Van Liere, K. D., Mertig, A. G., & Jones, R. E. (2000). New trends in measuring environmental attitudes: measuring endorsement of the new ecological paradigm: a revised NEP scale. *Journal of Social Issues*, 56(3), 425-442. doi: 10.1111/0022-4537.00176
- Dyer, P., Gursoy, D., Sharma, B., & Carter, J. (2007). Structural modeling of resident perceptions of tourism and associated development on the Sunshine Coast, Australia. *Tourism Management*, 28(2), 409-422. doi: 10.1016/j.tourman.2006.04.002
- Førde, A. (2016). Creating ‘The Land of the Big Fish’: A study of rural tourism innovation. In A. Viken (Ed.), *Place Reinvention*. London: Routledge. doi: 10.4324/9781315600574
- Gannon, A. (1994). Rural tourism as a factor in rural community economic development for economies in transition. *Journal of Sustainable Tourism*, 2(1-2), 51-60. doi: 10.1080/09669589409510683
- Garrod, B., Wornell, R., & Youell, R. (2006). Re-conceptualizing rural resources as countryside capital: The case of rural tourism. *Journal of Rural Studies*, 22(1), 117-128. doi: 10.1016/j.jrurstud.2005.08.001
- Gössling, S., Abegg, B., & Steiger, R. (2016). “It was raining all the time!”: Ex post tourist weather perceptions. *Atmosphere*, 7(1), 10. doi: 10.3390/atmos7010010
- Greaves, N., & Skinner, H. (2010). The importance of destination image analysis to UK rural tourism. *Marketing Intelligence & Planning*, 28(4), 486-507. doi: 10.1108/02634501011053586
- Gross, M. J., & Brown, G. (2006). Tourism experiences in a lifestyle destination setting: The roles of involvement and place attachment. *Journal of Business Research*, 59(6), 696-700. doi: 10.1016/j.jbusres.2005.12.002
- Harrison, C. (1991). *Countryside recreation in a changing society*. TMS Partnership.
- Hinkin, T. R. (1998). A Brief Tutorial on the Development of Measures for Use in Survey Questionnaires. *Organizational Research Methods*, 1(1), 104-121. doi: 10.1177/109442819800100106

- Hosany PhD, S., Zeglat PhD, D., & Odeh PhD, K. (2016). *Measuring Experience Economy Concepts in Tourism: A Replication and Extension*. Retrieved from <https://scholarworks.umass.edu/cgi/viewcontent.cgi?article=1505&context=ttra>
- Imran, S., Alam, K., & Beaumont, N. (2014). Environmental orientations and environmental behaviour: Perceptions of protected area tourism stakeholders. *Tourism Management*, 40, 290-299. doi: 10.1016/j.tourman.2013.07.003
- Iorio, M., & Corsale, A. (2010). Rural tourism and livelihood strategies in Romania. *Journal of Rural Studies*, 26(2), 152-162. doi: 10.1016/j.jrurstud.2009.10.006
- Jepson, D., & Sharpley, R. (2015). More than sense of place? Exploring the emotional dimension of rural tourism experiences. *Journal of Sustainable Tourism*, 23(8-9), 1157-1178. doi: 10.1080/09669582.2014.953543
- Josiam, B. M., Smeaton, G., & Clements, C. J. (1999). Involvement: Travel motivation and destination selection. *Journal of Vacation Marketing*, 5(2), 167-175. doi: 10.1177/1356766705052571
- Kastenholz, E., Carneiro, M. J., Marques, C. P., & Loureiro, S. M. C. (2018). The dimensions of rural tourism experience: impacts on arousal, memory, and satisfaction. *Journal of Travel & Tourism Marketing*, 35(2), 189-201. doi: 10.1080/10548408.2017.1350617
- Kastenholz, E., Eusébio, C., & Carneiro, M. J. (2016). Purchase of local products within the rural tourist experience context. *Tourism Economics*, 22(4), 729-748. doi: 10.1177/1354816616654245
- Kim, J. H., Ritchie, J. B., & McCormick, B. (2012). Development of a scale to measure memorable tourism experiences. *Journal of Travel Research*, 51(1), 12-25. doi: 10.1177/0047287510385467
- Kitnuntaviwat, V., & Tang, J. C. (2008). Residents Attitudes, Perception and Support for Sustainable Tourism Development. *Tourism and Hospitality Planning & Development*, 5(1), 45-60. doi: 10.1080/14790530801936452
- Lane, B. (1994a). Sustainable rural tourism strategies: A tool for development and conservation. *Journal of Sustainable Tourism*, 2(1-2), 102-111. doi: 10.1080/09669589409510687
- Lane, B. (1994b). What is rural tourism? *Journal of Sustainable Tourism*, 2(1-2), 7-21. doi: 10.1080/09669589409510680
- Moganadas, S. R., Corral-Verdugo, V., & Ramanathan, S. (2013). Toward systemic campus sustainability: Gauging dimensions of sustainable development via a motivational and perception-based approach. *Environment. Development and Sustainability*, 15(6), 1443-1464. doi: 10.1007/s10668-013-9451-3
- Nunnally, J. (1978). *Psychometric methods*. New York: McGraw-Hill.
- Oppermann, M. (1996). First-time and repeat visitors to New Zealand. *Tourism Management*, 18(3), 177-181. doi: 10.1016/s0261-5177(96)00119-7
- Page, S., & Getz, D. (1997). *The business of rural tourism: International perspectives*. London: International Thomson Business Press.
- Park, D., & Yoon, Y. (2009). Segmentation by motivation in rural tourism: A Korean case study. *Tourism Management*, 30(1), 99-108. doi: 10.1016/j.tourman.2008.03.011

Rid, W., Ezeuduji, I. O., & Pröbstl-Haider, U. (2014). Segmentation by motivation for rural tourism activities in The Gambia. *Tourism Management*, 40, 102-116. doi: 10.1016/j.tourman.2013.05.006

Sharpley, R. (1996). *Tourism & leisure in the countryside*. Elm Publication.

Swarbrooke, J. (1999). *Sustainable tourism management*. Cabi Publishing.

### **Contact information**

#### **Sandeep Kumar Dey**

Tomas Bata University in Zlín, Faculty of Management and Economics

Mostní 5139, 76001, Zlín, Czech Republic

E-mail: dey@utb.cz

ORCID: 0000-0002-9103-5422

#### **doc. Ing. Zuzana Tučková, Ph.D.**

Tomas Bata University in Zlín, Faculty of Management and Economics

Mostní 5139, 76001, Zlín, Czech Republic

E-mail: tuckova@utb.cz

ORCID: 0000-0001-7443-7078

doi: 10.7441/dokbat.2019.021



# INFLUENCE OF CONSTRUCTION OF LOGISTICS CENTRE ON TRANSPORT IN VIENNA

*Radek Dvořáček, Kateřina Víchová*

## **Abstract**

The aim of this paper is to find out how the construction of a new logistics centre in the vicinity of the A21 and B12 interchange will affect transport in Vienna. Transport in the city and near logistics centres plays a vital role. Today, a significant amount of goods is transported. Transport infrastructure is used for this purpose, where transport infrastructure represents a significant part. It is essential to note that the increasing number of goods transports may create transport problems in infrastructure. Thanks to the simulations, these problems could be detected and optimization could be proposed and verified again. In the paper firstly, there is introduced the current state of the traffic in the selected part of the Vienna. Secondly, there is introduced the software, which is used in this paper. There was selected the software for the microscopic traffic simulation - PTV Vissim. Next, there are presented the results of this simulation. Based on this simulation, there are shown potential traffic problems caused by the construction of this centre. Transport problems caused by the development of a logistics centre are not severe.

*Keywords: Logistics, A21, Vienna, Transportation, PTV Vissim, infrastructure*

## **1 INTRODUCTION**

In this work, an example simulation of the A21 and B12a off-road intersections located in the outskirts of Vienna will be solved. In the first part of this work will be given a detailed description of the roads, including maps of the streets. Subsequently, the work will be devoted directly to the intersection of the roads. In the last part, the simulation of this grade crossing in the PTV VISSIM program will be carried out first for the normal state of operation and then for the process with the logistics centre, which will be situated on Europaring. Given the current need for rapid transport of goods and materials, it is necessary to build logistics centres to ensure this flow of products and materials. The aim of this paper is to find out how the construction of a logistics centre will affect traffic on the interchange in Vienna. Due to the direct connection of the logistics centre to the motorway, it is not expected that the traffic density on the section will be increased too much.

## **2 METHODOLOGY**

PTV Vissim simulation program is used to find out how the construction of a logistics centre will affect traffic. Testing in reality would be too costly; simulation is used to solve this problem. The transport system is under intensive investigation through modelling and simulation. The simulation model describes the concrete abstractions of the proposed and is built on understanding the policy. The first component is the data that will be used on the model, i.e., traffic statics and information. The second component is a simulation algorithm that calculates the movement of vehicles (cars or anything else, such as trams, bicycles), with their specific acceleration and deceleration. The third component of visual simulation is motion animation and simulation results. The last part is verification (Pak, 2010). Nowadays, it is the simulations that are most suitable for solving this problem, because testing, in reality, would be too expensive. Logistics centres are best placed as close as possible to the main traffic arteries,

which is currently happening. Thanks to this location, it is possible to serve a large number of customers in various places without any problems and does not affect the surrounding area.

### 3 CURRENT STATE

The next part describes in detail the roads that this work covers. In the first place is described the most crucial highway, which is part of the grade crossing, namely the highway A21, then the road B12 and ultimately directly grade crossing these roads.



Fig. 1 – Location of grade crossing. Source: Mapy.cz (2019)

#### 3.1 Motorway A21

Wiener Außenring Autobahn A21 in German is a motorway in Austria and is part of the European Route 60. The A21 motorway connects the western A1 motorway, the most significant Austrian motorway linking Vienna and Salzburg, at the Steinhäusl junction with the southern A2 motorway Vienna to the Italian border, at the Vösendorf junction, where it opens to the unfinished Vienna S1 circuit. In the future, the A21 motorway, in conjunction with other motorways, namely the S1, A22, S5, S33, and A1, should form the so-called Regionenring. The entire “Regionenring” should be about 195 km long, and about 175 km has been completed. Upon completion, “Regionenring” will become the second-longest ring road after Berlin's Bundesautobahn 10 (196 km) and before the London M25 (188 km). (Asfinag, 2019)

#### 3.2 Brunner Straße B12

Brunner Straße is a 13.6 km long primary road B in Vienna, the provincial road B in Lower Austria, and the former motorway. The Brunner Straße leads from Mödling via BrunnamGebirge to Vienna, where it joins the B 221. In Vienna, the B 12 has the names Brunner Straße, Breitenfurter Straße, and Eichenstraße. The Brunner Straße is divided into two branches. The B12a leads from Perchtoldsdorf, crosses the A21 motorway, continues through Brunn am Gebirge, and finally connects to the B17 Wiener Neustädter Straße. The second branch of the B12b, the so-called Sageergasse, runs between Breitenfurter Straße and Altmannsdorfer Straße. B12b brings traffic to the A23 motorway, which is the busiest road in Austria, with 170,000 vehicles passing in 24 hours. (Asfinag, 2019)

### 3.3 Elevation crossing of the A21 motorway and B12A

The elevated crossing of the A21 motorway and the B12a road is located east of the town of BrunnamGebirge, in the province of Lower Austria and near the border with Vienna. This crossing mainly serves to connect the A21 and B12a roads mentioned here. Furthermore, this crossing serves as an arrival to Europaring, where there are various companies and hotels. In addition, the ultimate and essential purpose of this crossing is the arrival of vehicles from the A21 motorway to the already mentioned town of Brunn am Gebirge. (Asfinag, 2019)



Fig. 2 – Map background for crossing A21 and B12a. Source: Mapy.cz (2019)

This grade crossing is very complex. It consists of 13 so-called Ramps, which are used to connect the surrounding roads, and due to the use of connecting lanes, there is no excessive formation of columns, and traffic is thus smooth. However, there are also two traffic lights, both when connecting Ramp 1 to Brunner Straße (B12a) and Ramp 13 to Brunner Straße. At the exit of Europaring, there is also a roundabout. (Asfinag, 2019)



Fig. 3 – Location of crossings in the road network. Source: Wikipedia (2019)



## 4 RESULTS

The next part includes simulation results. The results are divided into two chapters, before the construction of the logistics centre and after the development of the logistics centre. The two simulations were then compared, and the change evaluated.

### 4.1 Simulation of the current state of grade crossing

When creating a simulation in PTV VISSIM, it was found that traffic lights did not affect traffic in any significant way. Still, there would be a potential to improve the situation, provided Ramp 1 and 13 were rebuilt to connect via the connection strip on the B12a road. There are no significant delays on other roads, and traffic is smooth. Due to the location of this crossing, in urban areas, the maximum speed allowed on the A21 motorway is 80 km / h and 70 km / h on the B12a road. On most ramps, the speed is not further adjusted, which means a maximum speed of 80 km / h. The traffic density in the VISSIM simulation was verified through the traffic density map implemented in Google Maps.

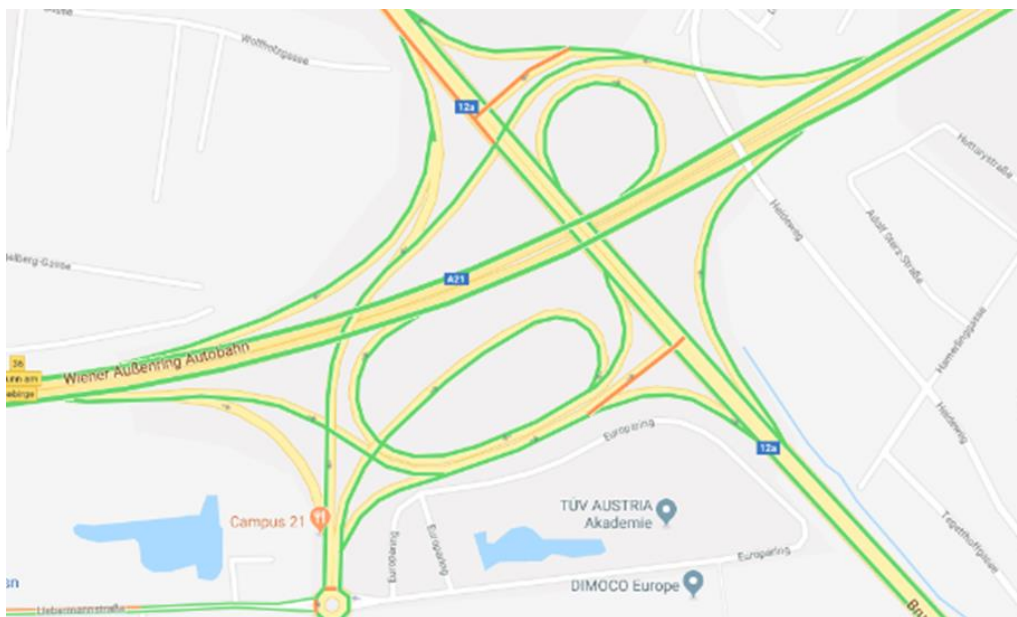

Fig. 4 – Traffic density. Source: Google Maps (2019)



Fig. 5 – General view of crossing in Vissim. Source: own research



Fig. 6 – General view of the crossing from the northwest. Source: own research



Fig. 7 – Detail of traffic lights. Source: own research



Fig. 8 – Flyover detail. Source: own research





Fig. 9 – General view from the west. Source: own research

#### 4.2 Simulation of grade crossing with logistics centre

The central task of this work was to find out what influence the construction of a logistics centre will have on traffic at a selected intersection. In this particular case, the logistics centre was located at Europaring. The traffic density was set at 300 LKW vehicles per hour, which is a relatively high value, but suitable for visualizing any traffic problems. Due to the author's knowledge, however, only communication with LKW transport from the warehouse was added, but not the arrival of LKW vehicles to the logistics centre. Despite the relatively oversized value of traffic from the logistics centre, no significant deterioration in transit was observed at the monitored intersection. Insignificant delays can occur at places controlled by light signalling devices and in front of a roundabout near the distribution warehouse.

According to the author, no or relatively low traffic deterioration is mainly because the logistics centre is located just at this grade-separated crossing, which means excellent accessibility to the main roads, in this case, the A21 motorway and the Brunner Straße B12a. It is the worsening traffic and availability on the main routes that are one of the essential points in the construction of the logistics centre. This warehouse location fulfils both of these aspects.



Fig. 10 – Location of the logistics centre. Source: own research



Fig. 11 – LKW vehicles leaving the distribution warehouse. Source: own research



Fig. 12 – Detail of traffic lights with LKW vehicles. Source: own research



Fig. 13 – Detail of exit of LKW vehicles on highway. Source: own research



Fig. 14 – A view of a variant with a logistics centre from the southeast. Source: own research

## 5 DISCUSSION AND CONCLUSION

In this paper, the intersection of A21 and B12a roads was solved, of which A21 is a motorway, and B12a is the main road. In the first part, the streets were described in detail, including their interest in the Austrian motorway and road network. The location of this crossing and both roads on the future Vienna circuit, also called the Regionenring, was discussed in this section. Subsequently, the crossing was modelled in the PTV VISSIM program to correspond as accurately as possible to the actual situation. Due to the unavailability of data, the traffic density was chosen according to the best knowledge and conscience of the author, so that it was as accurate as possible. According to this simulation, critical points were discovered, and then a better solution to these crisis points was proposed, but this was not simulated since it was not the subject of this work.

The main task of this work was to find out the change in traffic density after building a logistics center. After a detailed analysis of the possible locations of this warehouse, the most suitable option was the warehouse location option at Europaring. This location was chosen for availability on all critical roads. After simulating this variant, it was found that the traffic of LKW vehicles affected traffic on the crossing only minimally, and therefore, there is no risk of traffic collapse. Observable delays only occur at the roundabout leading from Europaring, which, however, due to the low traffic density at Europaring, does not consider the author a significant problem. All this work contains many pictures from the VISSIM program, which were chosen to reflect the traffic situation on the selected interchange accurately. The paper is also supplemented by map data for the exact location of this grade crossing.

### References

- Asfinag (2019). Retrieved from <https://www.asfinag.at/>
- Google Maps (2019). Retrieved from <https://maps.google.com/>
- Mapy.cz (2019). Retrieved from <https://www.mapy.cz/>
- Pak, H. C. (2010). *Simulátor dopravní sítě*. Praha: Univerzita Karlova.
- Wikipedia (2019). Retrieved from <https://de.wikipedia.org/>

### Contact information

#### Radek Dvořáček

Tomas Bata University in Zlín, Faculty of Logistics and Crisis Management  
Studentské nám. 1532, 68601, Uherské Hradiště, Czech Republic  
E-mail: r1\_dvoracek@utb.cz  
ORCID: 0000-0001-7446-8448

#### Kateřina Víchová

Tomas Bata University in Zlín, Faculty of Logistics and Crisis Management  
Studentské nám. 1532, 68601, Uherské Hradiště, Czech Republic  
E-mail: kvichova@utb.cz  
ORCID: 0000-0003-3420-9411

doi: 10.7441/dokbat.2019.022



# POSSIBILITIES OF USING GEOGRAPHIC INFORMATION SYSTEMS IN TRANSPORT

*Martin Džermanský*

## **Abstract**

Geographic Information System is a computer system that allows storing, managing and analysing spatial data. Nowadays we all use the possibilities of maps for smart devices. Whether it is for transportation, travel control or information. Geographic information systems can be used for transportation with which we can plan a route, look at traffic flow, traffic columns, and accidents and determine which route is best for us. This thesis describes the basic features of transport, geographic information system and the use of geographic information system in transport.

*Keywords: GIS, transport, software, systems*

## **1 INTRODUCTION**

Transport can be characterized as an activity related to the movement of persons and objects in various temporal spatial and volume contexts using various means of transport. Nowadays when modern technologies are increasingly being applied and mass digitization is taking place transport is also beginning to use and apply many technologies. Geographic information systems can be one of these technologies. Using geographic information systems it is possible to display individual stages of transport as well as their restrictions. Map portals are increasingly being used which are also used by individual cities to show the state of traffic to the public. There are closures, accidents, density but also other factors that can reduce traffic in any way.

## **2 METHODOLOGY**

In this work were used methods of analysis and simulation. Analysis is a process of thought or real decomposition of the examined object into individual parts, which becomes the subject of further investigation. The analyses were used for the comparison of the geographical information systems. Simulation is an imitation of the real thing, condition or process (Lorenc, 2007-2013). In this work was simulation used for simulation of transport in the software PTV VISSIM. In this SW was simulated the density of traffic in the city of Kyjov as the one of the possibilities of using the geographical information systems in the transport.

For this work were created map compositions of the network of the railroads in the Czech Republic and railway roads. Map compositions were created by geographical information systems and dataset of ArcČR 500. These map compositions show how could be used geographical information systems for the transport.

## **3 TRANSPORT**

Transport can be characterized as an activity related to the movement of persons and objects in various temporal, spatial and volume contexts using various means of transport. Nowadays, there are countless opportunities for transport and passengers (Zelený, 2007). Transport is a process, which we can, formulated as moving people or goods from point A to point B. There are many means of transport, whether it is a simple walk or a vehicle a bicycle, aircraft a ship

or a train as well as the associated transport facilities roads, airports, harbours and railroads. (ARCDATA PRAHA, n.d.; Eisler, Kunst & Orava, 2011)

Today transport is inherent in the day-to-day activities of people whether it is for their transport to work, shopping and school or anywhere for a trip. Transport is and will be our day's reservation anywhere. For example, there are 55,000 kilometres of roads, motorways and express roads in the Czech Republic are about 770 kilometres. Rail transport accounts for approximately 9400 kilometres of tracks. (ARCDATA PRAHA, n.d.; Kácal, 2014)

**Air transport** is one of the most used transports to transport people over long distances. Today, air travel is one of the busiest traffic at all. The advantage of this transport lies mainly in its safety. There are not so many accidents, collisions and it is very comfortable. One of its biggest advantages is its speed. Compared to road or rail transport, it saves tens of hours of travel. The benefits of air transport can therefore include its speed, comfort and safety. The disadvantages include weather and its impact on the environment. (Eisler, Kunst & Orava, 2011)

**Rail transport** is one of the most important transport sectors, although it is often referred to as an old transport sector because it has been used for more than a half-century. Today rail transport holds a high position very well and competes with other transport modes. Although it cannot offer such a more flexible response to the needs of passenger transport as compared to road transport, it replaces it by its capacity and its independence from the weather. Its advantages include the capacity of passenger and material transport and safety. Disadvantages include timetables, frequent delays and noise. (Eisler, Kunst & Orava, 2011)

**Road transport** is one of the youngest forms of transport in the world and is a very developing transport. Thanks to its speed and its operability, it competes very well with other modes of transport. Among the advantages of road, transport is its application both in domestic traffic as well as in international traffic. However, with the development of road transport there are also more frequent road accidents. Accidents in road transport reach the highest number of transport areas every year. These accidents often also cause environmental damage and loss of human lives. The advantages of road transport include speed, comfort, availability and purchase price. Disadvantages include accident rate, capacity and weather. (Pastor & Tuzar, 2007; Zelený, 2007)

**Shipping** is one of the first transports, which appeared in the world and allow the transfer of persons and property over a long distance. Compared to other forms of transport allows the transport of large quantities of material and provides a relatively fast moving. The transport itself can be divided into two categories namely inland swimmer and maritime transport. The advantages of shipping include in particular its capacity and favourable transport costs. The disadvantages include a limited network of transport routes, dependence on weather and high investment. (Zelený, 2007)

#### **4 GEOGRAPHIC INFORMATION SYSTEM (GIS)**

Geographic information systems are systems used for management, analysis and visualization of geographic data. These systems combine spatial and attribute information thus stores information about where something is and what it actually is. These linked data are called geographic information. Geographic Information System is thus an analytical tool that allows you to work with spatial relationships between objects so we can display data, maintain them, analyse and modelling them. It means that geographical information system is an integration of computer hardware and software. GIS is not just software but also other components like data, hardware, personnel and usage and GIS is not just a computer mapping system, although it is can also create. (Břehovský, & Jedlička, 2000; Miklín et al., 2018)

GIS consists of: (a) hardware - GIS is used on many devices, including a centralized computer server, desktop, tablet or smartphone; (b) software - GIS provides the tools and features needed to view, save, analyse and edit geographic data; (c) data - GIS cannot do without geometric and non-geometric data; (d) people - people include processors and GIS users; (e) procedures - GIS work is scheduled according to plan and certain creation rules.

Geographic data contains two but in some cases up to three basic types of information: (1) spatial information - describes its position, shape and their relationship to other objects; (2) descriptive information - they can also be labelled as attribute data and it is a property of a given object, type, name, and dimensions and so on; (3) time information - when this information is used, dynamic properties such as the date of the last repair are added to the system. (Břehovský, & Jedlička, 2000)

GIS data models are divided into two types, raster models and vector models. Raster model - is based on a cellular organization that divides space into a number of units. Each unit has a similar size as the other. Grids are the most common grid display. Each cell is assigned the X and Y coordinates as well as the value. This allows registration in the geographical reference system. Models created in this way have the disadvantage that their resizing causes a loss of quality so the closer we get it the worse the quality will be. Vector model - consists of three main elements, points, lines and polygons. Points are spatial objects without faces but can have attached attributes. Lines are spatial objects consisting of connected points that have no width. Polygons are closed areas that can be formed by the circumference of line segments.

The official definition of GIS from ESRI is: GIS is an organized collection of computer hardware, software and geographic data designed to efficiently acquire, store, modify, manage, analyse and display all forms of geographic information. For mapping serves a range of software applications. These can include for example ESRI ArcGIS, QGIS, OCAD.

#### 4.1 ESRI ArcGIS

ArcGIS is a geographic information system designed to work with spatial data. It is used to create and manage data and can analyse, find new relationships and visualize all these elements. Data created in ArcGIS are clearly displayed in the created map, which can also be interactive and connected with a number of databases. It also offers the possibility of data interconnection using WMS servers so it is possible for example to connect data from the server of the Czech hydro-meteorological system and others. (ARCDATA PRAHA, n.d.) The Figure 1 below shows the road network of the Czech Republic created in the software ArcGIS. The ArcČR500 data was used here, with which the individual road networks were inserted.

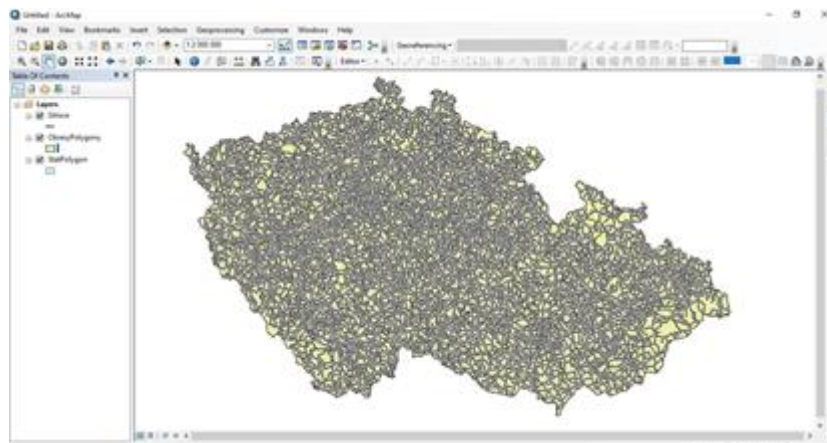

Fig. 1 – Demonstration of software ArcGIS. Source: own research

## 4.2 QGIS

QGIS is open source software, which was previously called Quantum GIS. Like ArcGIS software, it provides mapping with the ability to view, edit and analyse data and allows you to work with a wide range of raster and vector formats and databases. This project was founded in 2002. Currently QGIS software is being developed by a wide community of volunteers and professionals (Miklín et al., 2018). As a practical demonstration of the use of QGIS software for transport applications, a map containing the railway network of the Czech Republic was created below. The ArcČR500 data was used here to insert individual railway networks.

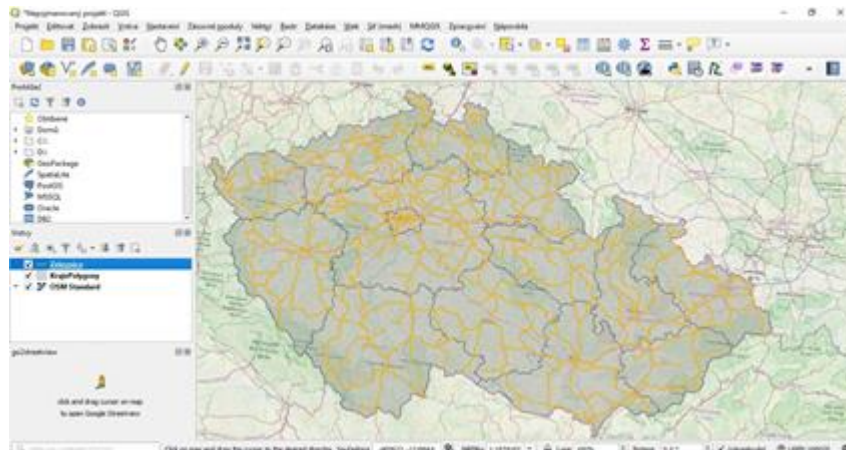

Fig. 2 – Demonstration of software QGIS. Source: own research

## 4.3 OCAD

OCAD is vector cartographic software for creating maps. This program is offered in two basic versions. These versions are OCAD for Cartography and OCAD for Orienteering. The difference between these two versions is that each focuses on a different target audience either classic cartography as provided by ArcGIS and QGIS or mapping for orienteering along with the design of the tracks for which the software was originally developed. (OACD, 2019)

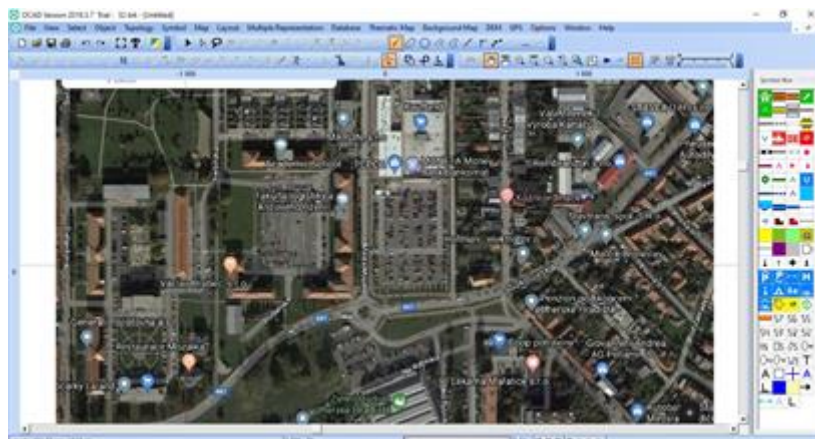

Fig. 3 – Demonstration of software OCAD. Source: own research

## 4.4 PTV VISSIM

PTV Vissim is a software that is used to microscopically simulate individual and public transport. The program can simulate traffic in cities including cyclists and pedestrians as well as individual sections of motorways and large intersections. PTV Vissim software thus simulates car traffic, pedestrian, cyclist and other road components. PTV Vissim combines



engineering experience with transport presentation in both 2D and 3D animation. PTV Vissim software is mainly used for network analysis, from simple intersections to large metropolises. In these areas road animations are created that include highways and utility roads. PTV Vissim uses geographic information systems. It uses an open street map as the base map. There are therefore to link geographic information systems and tools for creating PTV Vissim simulation of transport and transport systems. (AF CityPlan, 2017; Voženílek & Strakoš, 2009)

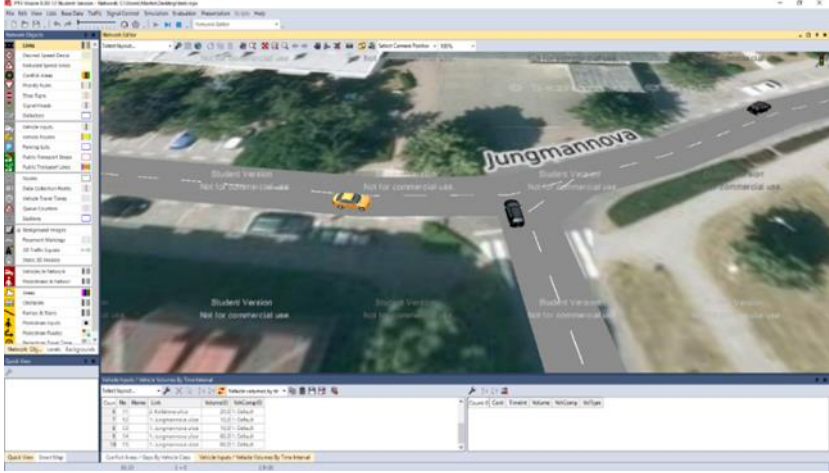

Fig. 4 – Demonstration of software PTV Vissim. Source: own research

To demonstrate the use of the PTV VISSIM program, a traffic simulation was created in selected sections of the city of Kyjov, which are the most fictional. With the help of traffic census statistics under the auspices of the Road and Motorway Directorate of the Czech Republic, traffic data was used and applied to the PTV VISSIM program.

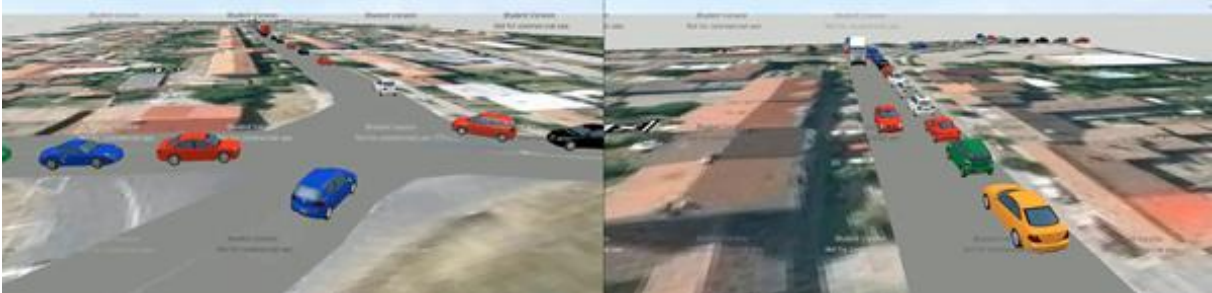

Fig. 5 – Simulation of traffic density in PTV Vissim. Source: own research

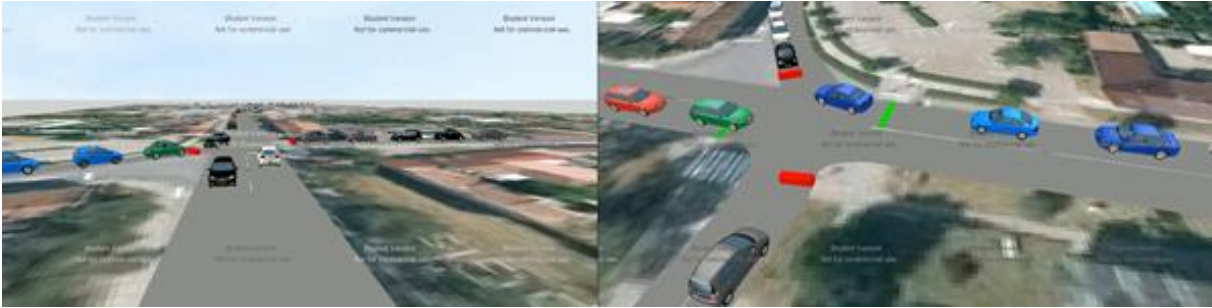

Fig. 6 – Simulation of traffic density in PTV Vissim. Source: own research

## 5 GIS IN TRANSPORT

Nowadays when digital map platforms are becoming more and more used and old prints are no longer used geographic information systems are on the rise. With GIS we can do anything. Geographic information systems have been used in transport especially in recent years. They are used for mapping of road and street networks, logistics, up-to-date accident reporting, road conditions, closures and traffic density, navigation systems, planning, maintenance, and registration of transport infrastructure, or emergency services that use navigation, location and surroundings and more.

Road networks are different from the topographic maps we are used to. Road networks consist of complex network charts described by vectors. This data can be obtained from road network operators such as the Road and Motorway Directorate of the Czech Republic. The data obtained in this way will save us a lot of time but it may not correspond to the current condition.

As the internet and wireless communications evolve faster, the number of internet and wireless applications using GIS for transport needs is increasing. These applications are most commonly used for driving directions, finding the shortest route possible, checking for congestion, columns, closures and traffic information. Navigation systems are slowly emerging as essential equipment in cars and smart devices. Along with wireless communications, these devices can also offer real-time traffic information and useful location services. GIS is also developing in the logistics industry. Because many companies are located in multiple countries and cities, GIS can show their customers all their branches, their routes and the way they deliver. (Shaw & Rodrigue, n.d.)

An example of the use of GIS in transport is the Waze mobile application. Waze gives you an overview of what is going on. It provides real-time information on traffic, road construction, police control and accidents. The application can also evaluate in real time the best route to the target according to the current traffic density.



Fig. 7 – Demonstration of application Waze. Source: own research

Another example of the use of GIS in transport is the information map portal of the City of Pilsen. This portal is freely available to the public and offers three types of Internet GIS map browsers with different demands and functions. Each map also provides a legend view with explanations and simple layer descriptions.

The first GIS Internet browser is the Traffic Map in Pilsen from traffic detector data. This application was created as part of the European project PoliVisu. The application serves as a tool to display the traffic intensity on the most important sections of roads in the city where traffic detectors are located to monitor the number of vehicles passing. In total traffic, density can be monitored on 307 sections of city streets fitted with detectors in the form of induction loops. The application stores data from March 1, 2017 until yesterday. When the application starts automatically read data from traffic detectors for the last 30 days and use them to calculate and display the map in average daily traffic for the current hour. (Mapový portal města Plzně, 2019a)



Fig. 8 – Demonstration of Traffic Map in Pilsen from traffic detector data. Source: own research

The second example of the use of GIS in transport is visualization of traffic intensity in Pilsen. This project was created in 2017. This application predicts traffic volumes on a specific day and hour based on measured data on the number of cars and based on scheduled closures for a specified date and time. Therefore, you can select the date and time in the application and the application will then display the current closures and traffic levels on the map. Data in the application are highlighted in colour according to their intensity and are described in detail in the legend. (Mapový portal města Plzně, 2019b)

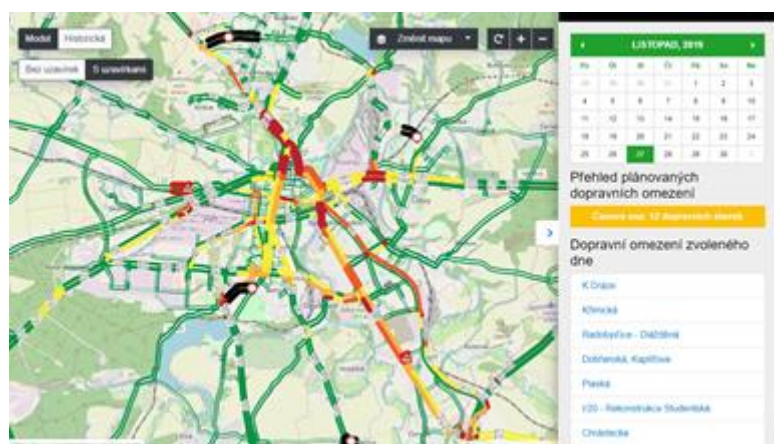

Fig. 9 – Demonstration of Traffic intensity in Pilsen. Source: own research



The third and last example of the use of GIS in transport in the city of Pilsen is the Map Project Transport. This project is intended primarily for employees of the Municipality and other organizations of the City of Pilsen but will also find its application in the public. You can find here information about closures, petrol stations, parking zones and more. All this information is sorted in the map into individual layers between which the user can choose. You can find here the category of public transport, which shows all Pilsen public transport lines including stops. In the application you can also find a category of communication network where is also cycling with layers of cycle paths, recommended cycle paths, and lockable cycle stands that can be used mainly by tourists. (Mapový portal města Plzně, 2012)

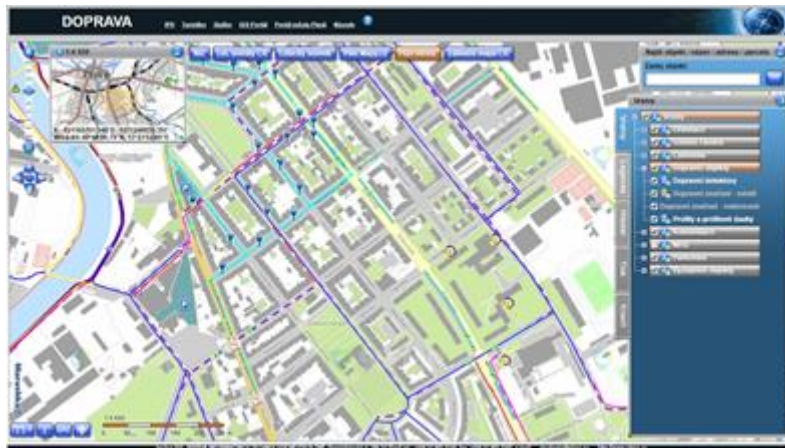

Fig. 10 – Demonstration of Map Project Transport. Source: own research

## 6 RESULTS AND CONCLUSION

In this paper there are given essential information about traffic and geographic systems and their interconnection. Geographical information systems are increasingly connected with the transport sector. Individual companies, municipalities, cities but also countries use geographic information systems to display their traffic data. With ever-increasing and sophisticated technologies, map bases and their layers are modernized and digitized to show current road conditions. They can identify the best possible routes for our transportation show negative factors that may make our journey unpleasant or affect us in any way such as road closures, road repairs, traffic jams, accidents or others.

The paper presents particular types of software designed for the creation of geographic information systems. Methods of analysis and simulation were used. As a practical example, a simulation was created in the PTV VISSIM program that shows the possible use of GIS in transport and map compositions were created, which are shown in the work under individual types of SW. Geographic information systems are systems that are applied in many sectors. They are very useful in transport and can help people very much.

The paper points to the various types of software and their employability. There is also listed a geographic information system, which are used for transport in the city of Pilsen. These systems point to the application of GIS in transport and their individual tools. There is also one case of using GIS in smart devices - WAZE application which serves as GPS navigation for cars and also provides up-to-date reports on traffic conditions, closures, controls and others.



## References

- ARCDATA PRAHA (n.d.). *Desktopový GIS: ArcMap*. Retrieved from <https://www.arcdata.cz/produkty/arcgis/desktopovy-gis/arcmap>
- Břehovský, M., & Jedlička, K. (2000). *Úvod do geografických informačních systémů*. Plzeň: ZČU.
- Eisler, J., Kunst, J., & Orava, F. (2011). *Ekonomika dopravního systému*. Praha: Oeconomica.
- Kácal, J. (2014). *Ekologické důsledky letecké dopravy*. Brno: VUT.
- Lorenc, M. (2007-2013). *Závěrečná práce – metodika*. Retrieved from <http://lorenc.info/zaverecne-prace/metodika.htm>
- Mapový portal města Plzně (2019a). *Mapa dopravy v Plzni z dat dopravních detektorů*. Retrieved from <https://mapy.plzen.eu/aplikace-a-mapy/tematicke-kategorie/doprava/mapa-dopravy-v-plzni-z-dat-dopravnich-detektoru.aspx>
- Mapový portal města Plzně (2019b). *Vizualizace intenzity dopravy*. Retrieved from <https://mapy.plzen.eu/aplikace-a-mapy/tematicke-kategorie/doprava/vizualizace-intenzity-dopravy.aspx>
- Mapový portal města Plzně (2012). *Mapový projekt Doprava*. Retrieved from <https://mapy.plzen.eu/aplikace-a-mapy/tematicke-kategorie/doprava/mapovy-projekt-doprava.aspx>
- Miklín, J., Dušek, R., Krtička, K., & Kaláb, O. (2018). *Tvorba map*. Ostrava: OSU.
- OCAD (2019). *The smart software for cartography*. Retrieved from <https://www.ocad.com/>
- Pastor, O., & Tuzar, A. (2007). *Teorie dopravních systémů*. Praha: ASPI.
- AF CityPlan (2017). *PTV Vissim*. Retrieved from <http://www.af-cityplan.cz/vissim-1404042539.html>
- Shaw, S. L., & Rodrigue, J. P. (n.d.). *Geographic Information Systems for Transportation (GIS-T)*. Retrieved from [https://transportgeography.org/?page\\_id=6741](https://transportgeography.org/?page_id=6741)
- Voženílek, V., & Strakoš, V. (2009). *City logistics: Dopravní problémy města a logistika*. Olomouc: UPOL.
- Zelený, L. (2007). *Osobní přeprava*. Praha: ASPI.

## Contact information

### Martin Džermanský

Tomas Bata University in Zlín, Faculty of Applied Informatics  
Nad Stráněmi 4511, 76005, Zlín, Czech Republic  
E-mail: [m\\_dzermansky@utb.cz](mailto:m_dzermansky@utb.cz)  
ORCID: 0000-0003-4149-2454

doi: 10.7441/dokbat.2019.023

# EVALUATION OF DEVELOPMENT OF SUPPLY OF THE SELECTED RESIDENTIAL SOCIAL SERVICES FOR ELDERLY

*Izabela Ertingerová*

## **Abstract**

The issue of demographic aging in the Czech Republic is and will be soon a more and more topic number one. In connection with this development trend, the social services sector, focusing primarily on the expanding target group in the post-productive age, is increasing at the forefront of state interest. The aim of this paper study is to evaluate the development of the offer of selected residential social services for the elderly - homes for the elderly and homes with special regime, according to providers, bed availability and financial security of individual facilities by the state. Evaluation of the development was carried out since 2007, when there was a fundamental change in legislation in the social services sector - the Social Services Act came into force until 2017. A simple measure of time series dynamics was used to map the development of the offer of residential social facilities for seniors. The results show that the offer of social services for seniors is insufficient in terms of the number of facilities and their bed capacity, with a slow rate of growth in relation to the annual growing number of persons aged 65+. With the adoption of a new social benefit, care allowance, the role of the state in the financial security of these facilities has increased. Nevertheless, individual social service providers face annual problems due to the insufficient amount of funds paid out from public budgets.

*Keywords: public sector, social services, retirement homes, supply*

## **1 INTRODUCTION**

Social services are the objects of a specific market which is realized within the public sector and the civic non-profit sector of the national economy. Demand is also specific and the supply on this market, since social services are public goods and public administration is both a guarantor of these services - responsible for their availability and, in many cases, a public service provider. (Průša, 2007)

Průša (1996) further states that developments in the field of social services are influenced by a number of influences that do not work independently but on the contrary interact, condition, including existing two-way interaction and feedback. The importance of these influences comes out and is strongly dependent on the historical conditions of individual territories (states). This issue mainly concerns demographic developments, socio-economic factors and socio-political determinants including international aspects.

The population projection not only in the Czech Republic but also in all European countries that the population is aging. Significant population aging is expected in the coming decades, when, according to data from the Czech Statistical Office, the population over 65 years of age reached over two million in 2019 with an annual assumption of further increase until the next peak in 2050 with the number of seniors at 3.2 million. The proportion of seniors in the total population will increase from the current 19% to 30%. According to a projection prepared by the European Commission pulsed in 2018, similar developments in the aging population are also expected in other European countries - an average expected increase in population of 21.6%. There is also a significant increase of 41% in the demand for social and health long-

term care services. These factors will significantly affect the quantity and quality of social services demanded for the elderly. (CZSO, 2019; European Commission, 2017).

The most common form of social services for seniors is residential facilities whose scope of legislation is regulated by law No. 108/2006 Sb., on social services. Specifically, these are homes for the elderly, homes with special regime and weekly care centres. These are the most expensive types of residential social services from the entire set of social services. In addition to the aforementioned law, pensions for the elderly, nursing homes and long-term care centres also operate on the social services market. As of 31st August 2019, there were 535 registered homes for the elderly and 354 homes for the elderly with a special regime, specializing in clients with reduced self-sufficiency due to chronic mental illness (dementia, etc.). (Registers of social service providers, 2019).

The social services sector is not able to respond quickly enough to the increasing demands on individual social systems resulting from an aging population. These are not only quantitative impacts on the economic side of the Czech Republic, but certain qualitative aspects also play a role. Also, the financial dependence of providers of residential social services on the granting and payment of subsidies from the state budget significantly limits the further development of social services. At the same time the low level of remuneration of employees in direct services and social workers is a long-term problem that needs to be addressed. This leads to a lack of professional staff in individual facilities or to a deteriorated quality of care provided. In extreme cases the absence of staff can result in a limited activity of the sanitary facility which translates into an extension of the waiting time for placement in the residential facility. (Association of Social Service Providers, 2017; Průša, 2015; Krebs, 2011).

The area of provision of residential social services for elderly has to deal with trends such as the annual increase in the number of persons over 65 years and the related increased demand for placement in individual facilities, stronger purchasing power of older people (pension savings, higher savings financing needs), extending life expectancy, better health care, the indispensable role of the state in social policy or increasing demands on the provision of high quality social services. (Hrozenská and Dvořáčková, 2013).

The aim of the paper is to evaluate the development of the offer of residential social services (homes for the elderly and homes with special regime) related to persons over 65 years, with regard to the structure and number of providers, bed capacity and financial expenditures from public budgets in years 2007-2017.

Two hypotheses were formulated in relation to the set a goal:

H1: "In the reference period 2007-2017, the share of social service providers other than public in the total supply of social services provided increased.";

H2: "In the reporting period, the level of public expenditure on social services for elderly and special care homes increased."

The key impetus for setting the above hypotheses was both the current demographic development and the related growing demand for residential social services and the state social policy including care allowances.

Evaluation of the overall development is carried out according to a simple measure of time series dynamics - the average absolute increase between 2007 and 2017 and the average growth coefficient in terms of bed capacity and economic indicators by types of social service providers (state and regional facilities, municipal, church and non-governmental facilities).

## 2 LITERATURE REVIEW

In the social services sector, after 1989 the transformation process began which led to the transformation of the social system of that time including all its attributes, into a new social system. According to Krebs (2007), Čámský, Sembdner and Krutilová (2011), the transformation process was very long and complicated, given that the social system at that time was not sufficiently prepared to address the social consequences of implementing economic reform. One of the main measures in the area of social transformation, as Průša (2007) points out, was the entry of municipalities and NGOs into the area of social policy.

Until 2006, the activities of social services were regulated by law No. 100/1998 Coll., on Social Security and by Decree No. 182/1991 Coll., by the Ministry of Labour and Social Affairs of the Czech Republic, implementing the Act on Social Security and the Act of the Czech National Council on the competence of the Czech Republic authorities in social security. Nevertheless, both of these legal regulations did not fully meet the needs of the social services sector, in terms of financial security, professional management, care and respect for clients' rights and obligations. A breakthrough moment occurred on January 1, 2007, when the new Act on Social Services came into effect, which comprehensively and independently regulates the entire area of social services. Its preparation took more than ten years and was significantly contributed to by the adoption of the so-called White Paper in Social Services, which includes the basic principles of providing social services. (Matoušek et al., 2007). The adoption of the Social Services Act categorized social services according to individual areas and forms of their provision (i.e. outpatient, terrain and residential), as well as setting certain obligations to social service providers, the structure of financing social services and, above all, cost.

A new condition for social service providers who are authorized to do so under the provisions of the Social Services Act is their obligation to register in the register of social service providers. The establishment of the register creates a basic overview of the extent and nature of the network of social service providers. At the same time it creates a prerequisite for drawing funds from public budgets, which positively encourages organizations and institutions to register and provide social services. Providers of social services can be legal entities - the Ministry of Labour and Social Affairs, territorial self-governing units and their contributory organizations and organizational units, non-governmental organizations and individuals. According to data from the Ministry of Labour and Social Affairs, the number of social service providers in the social services sector has increased since 2007 from 3,497 to 5,694, i.e. 2,197 providers. There was also an increase in the number of clients demanding social services, especially of a residential nature (MLSA, 2019). The Czech Republic is dominated by institutionalized care for the elderly, which is provided by public entities. Kubalčíková and Havlíková (2016) report that liberalization and replacement of residential care with alternative forms of full-time care is delayed by about two decades compared to Western Europe.

The social benefit, care allowance, has been transformed from social security benefits that were paid for a similar purpose under the previous legislation in force until 2006. The purpose of this transformation was to enable social service users to individually select social service providers and thus purchase specific social services. The user becomes a customer with a certain purchasing power, which is interesting for individual providers. Care allowances are provided to persons who are dependent on assistance from other natural persons according to their degree of dependence (light dependence, moderate dependence, severe dependence and complete dependence). (Průša, 2007) According to the Social Services Act, this allowance in residential social facilities belongs to the provider as payment for care.

The creation of the care allowance led to a sudden increase in state expenditures, not only mandatory but also non-mandatory, for securing the system of social services in the Czech

Republic. The original bill on social services in 2005 assumed that the cost of its payment from the state budget should reach about CZK 8 billion in 2007, but the actual value of the costs was significantly higher. In 2008, the Ministry of Labour and Social Affairs paid almost CZK 18.3 billion in contributions, nine years later, in 2017, it was already over CZK 25.1 billion. In general, the majority of the contributions paid is used to pay for residential services. The growing annual cost of paying care allowances from the state budget has a negative impact on the volume of state subsidies provided to social service providers. (Ministry of Labour and Social Affairs, 2005; CZSO, 2019).

### 3 METHODOLOGY AND DATA

#### 3.1 Methodology

To achieve the set goal, time series analysis was used within a simple measure of dynamics. Generally, the essence of time series analysis is the construction of a suitable model. The correct construction of the model allows us to understand the mechanism by which time series values are generated, while also understanding the conditions and relationships that affect these values. Due to changes in these conditions or linkages, it is possible to create a modelling reflecting their effect on changes in the development of the time series. Time series analysis can also be used to construct predictions of future behaviour. The procedures used are based on the principle of history, where this assumption is met with different accuracy in the real world.

Various elementary statistical characteristics can be used to obtain information about the behaviour of time series and the characteristics of the process represented by this series. These characteristics include differences (of different order), growth rates and averages of values. (Štědroň et al., 2012).

The most common characteristic of time series is the calculation of their average. When calculating them, it is necessary to consider whether the time series is interval or immediate. An important role here is the predicative ability of the indicator, which is recommended to be determined for time series with a trend where its value can be appropriately explained. The mean of the interval time series ( $\bar{y}$ ) can be mathematically written as the arithmetic mean of the values at each interval:

$$\bar{y} = \frac{1}{n} \sum_{i=1}^n y_i \quad (1)$$

Similarly, the chronological mean is used to calculate the mean of the instantaneous time series. The calculation formula can be written as:

$$\bar{y} = \frac{1}{n-1} \left[ \frac{y_1}{2} + \sum_{i=2}^{n-1} y_i + \frac{y_n}{2} \right] \quad (2)$$

If the distances between the individual observed moments  $t_1, t_2, \dots, t_n$ , in which the values of the given time series are determined are of the same length in the time series examined, this is an unbalanced chronological average.

Other indicators that should be measured include the dynamics and pace of time series. In their creation, time series are transformed from their original form.

Simple measures of time series dynamics serve to define the basic features of "time series" behaviour and formulate certain criteria for their subsequent modelling. The simplest characteristic of the rate of dynamics is the absolute increment (the first difference), which can be calculated as the difference of two consecutive time series values:

$$\bar{y}_n = y_n - y_{n-1}, \quad n=2, \dots, N \quad (3)$$

The observed result shows the extent to which the value of the monitored variable has changed from the base period. Based on the given calculation it is possible to determine the trend of time series. Frequently used is also the calculation of the average absolute increment, which expresses the change in the average value of the time series per unit time interval:

$$d = \frac{y_n - y_1}{n-1} \quad (4)$$

A very important characteristic of the rate of time series dynamics is the growth rate, expressed as a growth coefficient. The rate of growth shows the extent to which the value of the measured characteristics has changed, most often in percentage terms or in decimal figures. The average growth rate, or average growth coefficient, is calculated as the geometric mean of each growth coefficient:

$$k = \sqrt[n-1]{\frac{y_n}{y_1}} \quad (5)$$

In addition to being used directly to characterize the time series dynamics, growth factors are also used as one of the criteria for finding a suitable trend function. (Kropáč, 2009; Budíková et al., 2010).

### 3.2 Data

As already mentioned, as at 31 August 2019, a total of 5,694 social service providers were registered in the Czech Republic. Of this number, 889 providers offer residential social services for the elderly (homes for the elderly and homes with special arrangements). The legal form of these providers of residential social services is diverse.

In order to evaluate the development of the accessibility of residential social services from the point of view of their providers, four groups of facilities were analysed according to the type of providers: (a) government and regional facilities; (b) municipal facilities; (c) ecclesiastical facilities - churches, charities, deacons, etc.; and (d) other (non-state) facilities - civic associations, public benefit organizations, foundations, etc.

The time analysis for the period 2007-2017 monitors the development of individual groups of providers in terms of their total number and capacity of facilities (number of beds).

In the analysis of financial indicators, attention is paid primarily to the income side of individual residential facilities, which consists primarily of payments for and care provided by clients and subsidies paid by the state and their founders.

In the area of social services, the principle of multi-source financing has been applied for a long time. Key sources of funding for residential social services include subsidies and care allowances paid from public budgets, nursing payments and rehabilitation care from public health insurance sources and, last but not least, payments from clients from their pensions.

## 4 EMPIRICAL RESULTS

The results of the evaluation of the development of selected residential social services for the period 2007-2017 are defined in terms of (a) their providers and total capacity, (b) the funds received for activities paid from public sources and (c) the total offer of residential services in relation to demographic development persons over 65 years of age.

#### 4.1 Results I: Structure and capacity of residential social services facilities for elderly

According to the founder, the assessment of the development of the provision of residential social facilities for seniors over a one-year period cannot be considered heterogeneous (Fig. 1). In general, the annual increase in the number of newly registered residential social facilities - homes for the elderly and homes with special regime - is obvious. In 2017, residential social services were provided by 56% more providers than in 2007. This trend can be expected to continue in the coming years, as demand for these services significantly exceeds the existing offer, which has years insufficient.

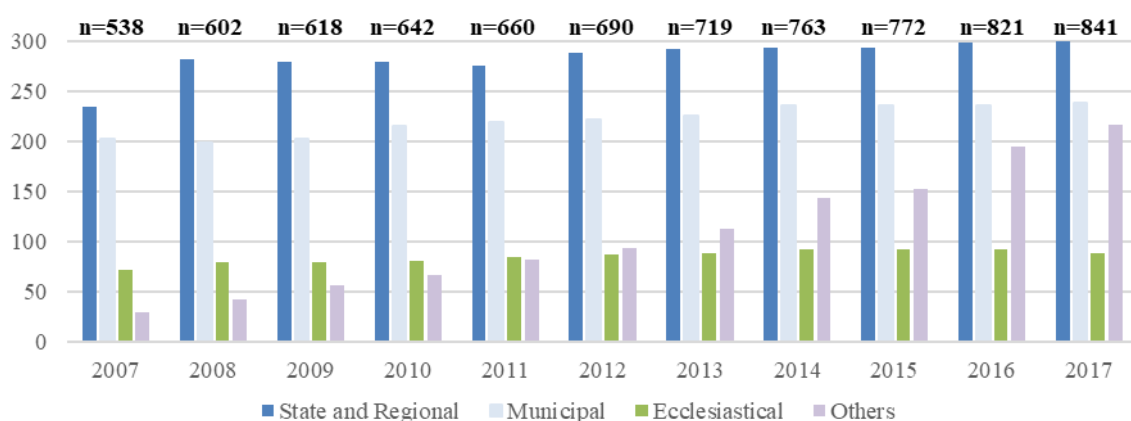

Fig. 1 – Development and structure of providers of social facilities. Source: CZSO (2019), MLSA (2019)

The state is the body determining the main conditions for the activities of social services; Regional and municipal governments play a dominant role in meeting the demand for this type of facility, i.e. ensuring a territorially accessible network. In their case, the annual increase, with some exceptions, was gradual. Especially with other non-state providers, their significant annual growth is evident in the period under review. Their share in the total number of providers grew annually, compared to public providers. The establishment of non-state residential facilities arises mainly because the state does not work sufficiently effectively or even not at all. Practically unchanged developments in the number of facilities can be observed in the case of church providers.

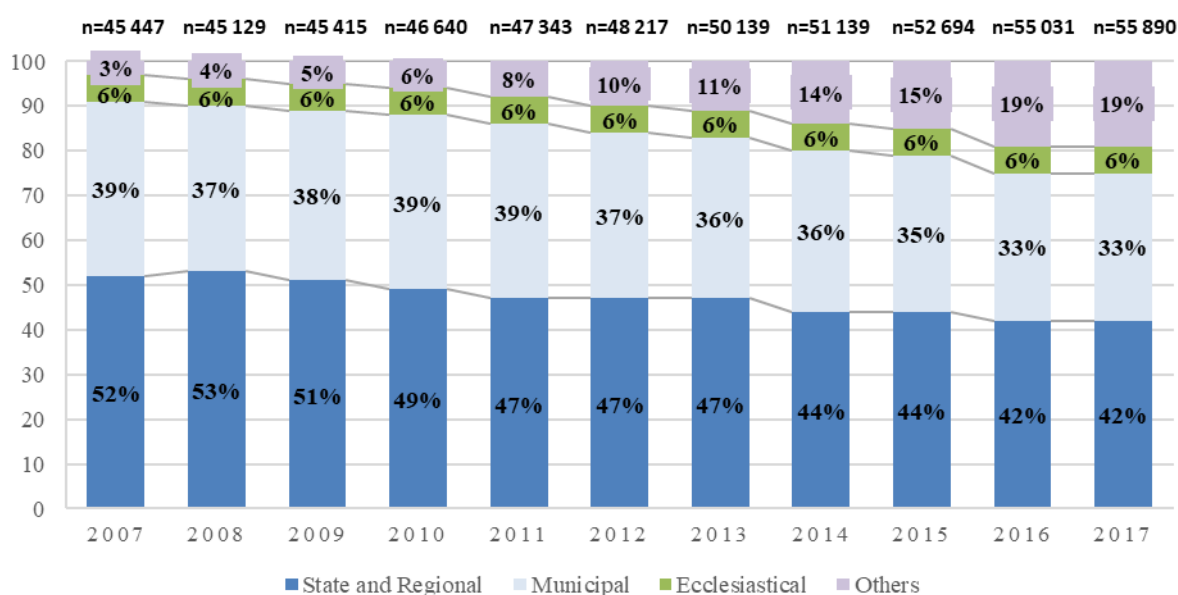

Fig. 2 – Development of bed capacities of providers of social facilities. Source: CZSO (2019), MLSA (2019)

The given development was subsequently also reflected in the number of bed capacities in selected social facilities (Fig. 2). In the 2007-2017 reporting period, except for a slight fall in 2008, there was a gradual slight increase in the number of beds, with the most significant increase between 2015 and 2016 due to newly registered NGOs. In recent years, almost 75% of the total capacity of facilities for social services for seniors is provided by organizations that are set up by territorial self-governing units (regions and municipalities).

The results of the monitored parameters are characterized in Tab. 1, which contains average recalculated values for the period 2007-2017 for all types of providers of residential social services. Between 2007 and 2017, there was a positive absolute increase “d” for all providers within the monitored number of facilities and bed capacity, except for changes in the bed capacity of state and regional facilities. The most significant values of absolute increment “d” were achieved by other non-profit entities in terms of both the total number of facilities and bed capacity.

Tab. 1 – Average values of monitored parameters. Source: own research

	Number of buildings			Capacity of the buildings		
	2007-2017	d	k	2007-2017	d	k
<b>State and Regional</b>	282	6,5	1,025	23 115	-40,9	0,998
<b>Municipal</b>	221	3,6	1,016	18 029	33,9	1,002
<b>Ecclesiastical</b>	85	1,6	1,020	3 000	33,1	1,011
<b>Others</b>	108	18,6	1,218	5 277	1 018,2	1,259

The growth coefficient “k” is considerably positive, as indicated by the absolute increase, for other providers, while the only negative one is recorded for state and regional facilities within the capacity of the facility.

#### 4.2 Results II: Financing residential social facilities for seniors

Residential social services rank among the whole set of provided social services among the most expensive services in terms of ensuring their operation and provided social services. Matoušek et al. (2013) states that up to 80% of the total financial resources for social services are paid for the activities of residential facilities every year.

As already mentioned, the key incomes of residential facilities include paid subsidies from the state and the founders and own income for services provided, which consist of care and reimbursement from clients (their pensions). Fig. 3 shows their development over the 11-year period under review, including the total income.

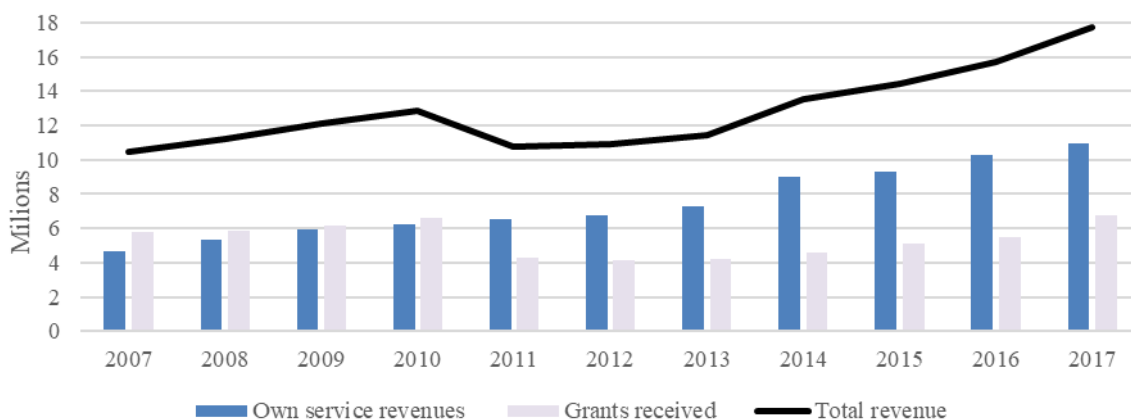

Fig. 3 – Development of financing structure of selected facilities. Source: CZSO (2019), MLSA (2019)



It is apparent from the development that until 2010, subsidies paid or received from the state budget exceeded or were in line with the equipment's own revenues for the services provided. In 2011, a significant drop was recorded due to the termination of individual regional projects and, above all, stagnation from the resources of the Ministry of Labour and Social Affairs, which practically did not reflect the finalization of these projects. In the following years, their very low level of payments is evident. Especially in the years 2011-2014, their constant development was recorded, although the number of newly registered residential facilities increased every year. Only since 2015 is there a slight increase in disbursements. The low level of subsidies paid was also related to the stipulated increase in salary tariffs in the social services sector; for this reason, there were no more funds available in the state budget for the operation of residential facilities.

Positive gradual annual development is evident in the case of own providers' revenues. An important role (approx. 70%) was played here by paid care allowances, which were gradually applied for by more and more persons and which are used by the residential facility as a reimbursement for care.

From the point of view of types of providers of residential services for seniors (state, regional, municipal and others), it is possible to see a considerable difference in the average values of their income pages (Table 2). For all providers, not only a positive absolute increase “d” (with the most significant value for other types of providers in terms of own revenues from services), but also a positive growth coefficient “k” was recorded, both within the monitored economic indicators.

Tab. 2 – Average values of economic parameters. Source: own research

	Own service revenues			Grants received		
	2007-2017	d	k	2007-2017	d	k
<b>State and Regional</b>	3 464 992	206 308	1,063	2 821 884	36 825	1,011
<b>Municipal</b>	2 639 008	179 051	1,072	1 961 572	26 852	1,012
<b>Others</b>	1 380 106	240 861	1,203	580 937	34 201	1,055
<b>Total revenue</b>	7 484 106	626 220	1,089	5 364 394	97 878	1,016

### 4.3 Results III: Structure of supply of residential services in relation to the population 65+

The analysis of the development of the total offer of residential social services for seniors since 2007 in terms of the total number of facilities, bed capacity and disbursed funds from public budgets was subsequently compared with the demographic development of persons over 65 years, i.e. with the main target group of these facilities.

In Tab. 3 shows the development of the number of (i) residential facilities for seniors per 1 000 population aged 65+; (ii) occupancy (beds) in homes per 1 000 persons aged 65+; and (iii) conversion of received funds from public budgets per 1 000 inhabitants over 65 years of age in CZK.

Tab. 3 – Conversion of observed economic parameters per 1 000 population 65+. Source: own research

	2007	2008	2009	2010	2011	2012	2013	2014	2015	2016	2017
i	0,356	0,386	0,386	0,392	0,388	0,390	0,393	0,405	0,399	0,412	0,412
ii	30	29	28	29	28	27	27	27	27	28	27
iii	6 926	7 214	7 558	7 874	6 350	6 193	6 286	7 217	7 470	7 899	8 685

The table shows that the offer of residential social services is insufficient for the target group. Also, public budgets per 1 000 people of post-productive age are growing every year. It can be

assumed that the current number of facilities and their bed capacity will not be sufficient in the coming years, according to the presented prognosis of demographic development. It is therefore imperative to respond in time to the anticipated demographic situation, for example by developing residential or field facilities at the municipal and regional levels.

## 5 DISCUSSION AND CONCLUSION

The aging population is a problem for which the social services sector should be prepared in a timely and responsible manner. Although the long-prepared new law on social services came into effect in 2007, its overall structure and conception was based on European principles and solutions to social services issues, previous problems have not been eliminated, many of them have paradoxically deepened and another new one has arisen. The current system of social services in the Czech Republic cannot be considered optimal, but it should be noted that it is a more efficient and transparent system than it was before 2007. (Horecký, 2010; Průša, 2015; Kubanová and Linda, 2014).

Two hypotheses were formulated to fulfil the set goal, to evaluate the development of the offer of residential social services for seniors in the period 2007-2017. Verification of the first hypothesis showed that since 2007 there has been a gradual increase in the number of newly registered providers of residential social services for seniors in a form other than state organizations. These are primarily organizations that have responded to the insufficient supply of residential services for the elderly in order to address and prevent specific problems in the area. At the same time, the number of regional and municipal residential facilities decreased by about 15% since 2007. The hypothesis can therefore be confirmed.

The second hypothesis was set to confirm/disprove the claim that the amount of public expenditure on social security services of residential character increased. It can be stated that in the period under review, expenditures from public sources for securing social services of assessed residential facilities for seniors increased every year. This was greatly contributed to by the new social benefit, the care allowance, which made the stay of individual clients less expensive. However, the payment of care allowances from the state budget was also negatively reflected in the values of subsidies paid. The low level of subsidies provided, and above all the financial dependence of individual providers of residential social services on the granting of subsidies, has a negative impact on the overall operation of the facility. It may reduce the number of employees or even interrupt the overall operation. Although expenditures from the state budget for residential social services are increasing every year, especially in the framework of the costs of care allowances, this is not sufficient to fully and smoothly cover all necessary costs related to the provided service. Insufficient funding for residential social services prevents providers from extending these services and improving their care. The method of financing residential social services seems to be quite unsatisfactory. At the same time, the residential social services sector is facing not only the problem of paying low subsidies, but also the long-term under-funded nursing and rehabilitation care. (Čevela et al., 2012)

Currently, there is no central plan that applies to the construction of the capacity of social services for seniors, not only in residential but also field services. The current strategic documents do not deal with the issue of lack of residential facilities, bed capacity, including proposals for a systematic plan to address these problems. In contrast to other European countries, the Czech Republic has long been below the European average in the number of bed capacities of residential facilities for people of post-productive age. This is due to the fact that developed countries are responding to growing demand due to demographic development, which is minimal and at the same time with a significant delay in the Czech Republic. There is a risk that the social services sector will collapse in the future if there is no systemic and

systematic change in the form of the development of residential social facilities in the near future, especially in terms of bed capacity. (European Commission, 2018)

### Acknowledgements

This paper was supported by project SGS No. SP2019/10, Impact of Socio-Economic Factors on Availability of Selected Social Services in the Czech Republic, Faculty of Economics. VSB - Technical University of Ostrava.

### References

- Association of Social Service Providers (2017). *Akutní nedostatek pečovateli a pečovatelek v sociálních službách již ochromuje celý systém*. Retrieved from [http://www.apsscr.cz/images/1493015895\\_tz-akutni-nedostatek-pecovatele-a-pecovatelek-v-socialnich-sluzbach-jiz-ochromuje-cely-system.pdf](http://www.apsscr.cz/images/1493015895_tz-akutni-nedostatek-pecovatele-a-pecovatelek-v-socialnich-sluzbach-jiz-ochromuje-cely-system.pdf)
- Budíková, M., Králová, M., & Maroš, B. (2010). *Průvodce základními statistickými metodami*. Praha: Grada Publishing.
- CZSO (2019). *Vybrané údaje o sociálním zabezpečení*. Retrieved from <https://www.czso.cz/csu/czso/vybrane-udaje-o-socialnim-zabezpeni-2017>
- Čámský, P., Sembdner, J., & Krutilová, D. (2011). *Sociální služby v ČR v teorii a praxi*. Praha: Portál.
- Čevela, R., Kalvach, Z., & Čeledová, L. (2012). *Sociální gerontologie*. Praha: Grada Publishing.
- European Commission (2017). *The 2018 Ageing Report: Underlying Assumptions and Projection Methodologies*. Brussels: European Commission.
- European Commission. (2018). *Challenges in Long-Term Care in Europe*. Brussels: European Commission.
- Horecký, J. (2010). *Capacity, Accessibility, Structure and Quality of Social Services*. Tábor: Association of Social Service Providers.
- Hrozenká, M., & Dvořáčková, D. (2013). *Sociální péče o seniory*. Praha: Grada Publishing.
- Krebs, V. (2011). Důchodová reforma v České republice. In T. Löster and J. Langhamrová (Eds.). *RELIK 2011: Reprodukce lidského kapitálu - vzájemné vazby a souvislosti*, Prague. Slaný: MELANDRIUM.
- Kropáč, J. (2009). *Statistika B: Jednorozměrné a dvourozměrné datové soubory, Regresní analýza, Časové řady*. Brno: Vysoké učení technické v Brně.
- Kubalčíková, K., & Havlíková, J. (2016). Current Developments in Social Care Services for Older Adults in the Czech Republic: Trends towards Deinstitutionalization and Marketization. *Journal of Social Service Research*. 42(2), 180-198. doi: 10.1080/01488376.2015.1129014
- Kubanová, J., & Linda, B. (2014). The Process of Population Aging and its Impact on Country's Economy. *Political sciences, Law, Finance, Economics and Tourism*, 4, 767-774.
- Matoušek, O., et al. (2007). *Sociální služby: legislative, ekonomika, plánování, hodnocení*. Praha: Portál.

- Matoušek, O., et al. (2013). *Metody a řízení sociální práce*. Praha: Portál.
- Ministry of Labour and Social Affairs (2005). *Návrh zákona o sociálních službách*. Praha: Ministry of Labour and Social Affairs.
- MLSA (2019). *Register of Social Services Providers: Evidence of Social Services Providers*. Retrieved from <https://www.mpsv.cz/web/cz/registr-poskytovatelu-sluzeb>
- Průša, L. (1996). Sociální politika a determinanty jejího vývoje. *Sociální politika*, 1996(1).
- Průša, L. (2007). *Ekonomie sociálních služeb*. Praha: ASPI Publishing.
- Průša, L. (2015). *Důsledky stárnutí populace na potřebu služeb sociální péče do roku 2030*. In Demografie, revue pro výzkum populačního vývoje - č. 3/2015. Retrieved from <https://www.czso.cz/csu/czso/demografie-revue-pro-vyzkum-populacniho-vyvoje-c-32015>
- Štědroň, B., Potůček, M., Knápek, J., Mazouch, P., et al. (2012). *Prognostické metody a jejich aplikace*. Praha: C. H. Beck.

### **Contact information**

**Ing. Izabela Ertingerová**

VSB - Technical University of Ostrava, Faculty of Economics

Sokolská 33, 70200, Ostrava, Czech Republic

E-mail: [izabela.ertingerova@vsb.cz](mailto:izabela.ertingerova@vsb.cz)

ORCID: 0000-0002-6182-4471

doi: 10.7441/dokbat.2019.024

# THE FACTORS INFLUENCING SENSORY MARKETING IN NON-FOOD RETAIL

*Michael Faflek*

## **Abstract**

At present, sensory marketing is mainly used in food retailing, where sellers are trying to influence all the senses. In non-food retailing sellers are concentrating on music (hearing), and on store's appearance (sight). Because competition is still growing, it is important to learn how to differentiate from competitors in areas than just in prices, services and advertisement. It is important to focus on making the customer feel comfortable in the shop. For this we use in-store communication, when one of the tools is sensory marketing, which is focusing on five human senses – taste, touch, smell, hearing, sight. Main goal of paper is to describe literature review from available literary sources, find gaps in literature review and outline a future research of sensory marketing in non-food retail. First part is focusing on sensory marketing and it's using in non-food retailing. Next part of work is dealing with senses, how they work without using another sense. Every sense is analysed, what is for specific sense pleasing and what is not pleasing. How some incentives act on sense etc. In the last chapter will be presented research questions, limitation and graphically outlined steps of research.

*Keywords: sense, sensory marketing, sight, hearing, smell, taste, touch*

## **1 INTRODUCTION**

Nowadays is very important to be a different from other competitors and earn the biggest share on market. If competitors offer similar products as us, it is very important to be a different in marketing communication. In shops we can differ within in-store communication, which is part of sales promotion.

In food retailers, where is offered same goods, they are differentiating at price and they trying to differ how the shopping place act on customer. Marketers are often using in point of sale sensory marketing, when they are attempting to influence all five senses of customer. For example, music in shops determines speed of purchasing. Appearance of shop (acts on the eyes) should look great, that make a customer feel good in there. In shop can be stands, which are offering samples of food, marketers are trying to influence taste and it can stimulate demand. And very important is smell in shop. Some kinds of smell can stimulate demand and another cannot. That is why is important to analyse what smell can have good results in shops. Last sense – touch can be in food retailers used that the customer have an option to use shop basket or how floor act on customer (bumps on floor etc.).

Because sensory marketing is one of the forms of in-store marketing, firstly literature review deal with in-store marketing. After that paper is focusing on sensory and emotional marketing and after that are senses described and how can marketing target on them. It follows chapter, which contain description of future research such as research gap, steps of research and research questions. In last chapter are described limitation of research.

## **2 THEORETICAL BACKGROUND**

Main goal of literature review is described in-store communication, sensory marketing, its using and individual senses.

Nowadays sensory marketing is very questionable also in literature. If you search “sensory marketing” in main research databases, on Web of science you will discover 131 articles and in Scopus database 45 articles. These articles devote to this topic. Sensory marketing, we understand as one of the tools in-store marketing, which belongs to tools, which influence behaviour of customer in point of sale.

## **2.1 In-store marketing**

In-store marketing is one of the effectively elements sales promotion. In-store marketing are types of advertising, which are used inside of shop and are used to influence purchase behaviour of customer. Point of sale is the last place, where you can change the decision of customer. (Boček, 2009)

Boček (2009) noted, that resources of in-store marketing communication can be described as POS (Point of Sale) or POP (Point of Purchase).

Boček (2009) divide POP on:

- a) On the floor – stands, displays, banners, product models, advertising trash bins, graphics on the floor etc.;
- b) Shelf – wobblers, stoppers, separators, samples holder etc.;
- c) Close to the cash desk – displays, leaflet holder, banners etc.;
- d) On the wall – light adverts, banners, flags etc.;
- e) Other – parasols, graphics on window, terminals, decorative packaging, inflatable banner etc.

One of the options how to stimulate customers in POS is using sensory marketing.

## **2.2 Sensory marketing**

On the beginning is very important to say what sensory marketing mean. Sensory marketing is type of marketing, where you are trying stimulate senses of customer to persuade him to purchase. You can do it via activities focusing on product, distribution and communication. (Boček et al., 2009)

Krishna (2010) noted that the mission of sensory marketing is engage senses before purchase and create the product more attractive for customer. Lindstrom (2005) wrote that the using two senses or all of five senses can differentiate strong brands from the weaker. Vysekalová (2014) believe, that customers are buying products by eyes, because with eyes you control 80% of purchase. But using all of senses is more effectively and that is called multisensory marketing or marketing using all of senses. Underhill (2009) noted, that all unplanned purchases are result of seeing, touching, listening, smelling and tasting inside of shops. And this is the reason, why in-store marketing has bigger impact then other types of marketing communication. According to Štibinger (2010) probability of creating strong and emotional relationship with point of sale is increasing according to how many senses are involved.

Lindstrom (2009) highlight research of Calvert. The research dealt with problem of affecting on all senses simultaneously. In the first part of research all respondents received visual materials of global brands, next part was focused only on smell. From results we know that both stimulus (visual and aromatic) were for respondents pleasant. But if respondents were affected both of stimulus, it was for them more pleasntry than in first situation. Calvert thanks to neurologic researches noted, if pleasant smell is corresponding to sympatric visual stimulus, it

is more positive for us and it is easily memorable. But if smell is not suitable for visual stimulus, brain has tendency these stimuluses reject and forgot.

Research of Géci et al. (2017), which was focusing on influence sensory marketing on purchasing behaviour find out, that most affected sense when buying food is sight, second is taste, third smell and last are hearing and touch. Research was focusing too what is more pleasant for senses, for sight it was colours, for hearing it was music from radio, for smell it was vegetable.

Shabgou et al. (2014) noted, that lot of today's consumers are not watching television adverts, that's why sales managers should invest more money to provide better shopping experience, which will affect mind and heart of people. Human senses have decisive role in purchasing decisions. On base of research Shabgou et al. (2014) noted that five senses influence 21.4% of consumers. The biggest impact on behaviour has taste, on second place is touch. These results were similar to results of other researches.

### **2.3 Sensory and emotional marketing**

To differentiate brand or product from competitors, you need to be still ahead of them. Only using ordinary marketing tools doesn't have to work anymore. That's why customers are asking for emotional experience and passion for all of senses. Ordinary visual adverts and ordinary was of communication is for them like one big advert smog. (Lindstrom, 2010)

Emotions accompany all our actions and are completely subjective, which means that each person reacts differently to a given stimulus. It is a phenomenon that consists of feelings that express a certain situation and behaviour. To take into account emotions in marketing communications, it is important to consider that emotions are tied to a particular situation at a given moment. Emotions are unrepeatable, so we can recall the perception that evoked certain emotions, but not the same emotions because they change with the moment. If customer had negative experience with product, the same negative emotion can be seen in other products of the same brand. Of course, this also applies to positive emotions, but the difference is that negative emotions are usually stronger. The important thing for marketing communication is that emotions are portable. (Vysekalová, 2014)

### **2.4 Basic senses and their basis for sensory marketing**

The following subsections describe the five senses and their application in sensory marketing. They are ordered in sequence as they develop during human embryo growth: touch, smell, hearing, taste and sight.

#### **Sight and visual marketing**

Sight is the dominant sense; it can be described as the most powerful of all five senses. Of all the information, which the brain processes, 83% are visual. This information flows into the brain through the eyes. Up to two thirds of all sensory cells in the human body are located in the eyes. (Lindstrom, 2005)

According to Pradeep (2010), one quarter of the brain's capacity is evaluating visual perceptions, for example, if information is disseminated simultaneously by sound and image, our brain assigns higher priority to image information.

Visual marketing is not just about products, it is about the entire point of sale. It is necessary to attract the customer's attention, so the outward appearance of the store must be conspicuous and attract the consumer. (Boček, 2009)

For sight in point of sale is most important light, graphics and design. Lights can evoke an atmosphere that can affect the mind and mood of the customer. Of course, properly lit product can significantly improve its perceived value. The appearance of employees is also important for visual in-store communication. (Vysekalová, 2012)

Also, according to Boček et al. (2009) the outward appearance of the store should arouse desire to visit the store. The point of sale must invite the potential customer inside, not create obstacles in the form of a dark environment or a hard-to-reach entrance. But sometimes we can deviate from the rule, if we want to focus on special target group.

Shapes and especially colours help the communication tools to get out of the background. The colours have a psychological and economic impact on the customer and cause various reactions. For marketing communication is important both the way of colour perception and the psychology of colours. Basic of colour psychology is from J. W. Goethe, he divided colours on cold and warm. With psychology of colour is also relate symbolism. For example, that black and white in most cultures is associated with good and evil, red is associated with fire, power and love. (Vysekalová, 2012)

Point of sale should have cold colours, because these colours have positive soothing effect and creates pleasant environment for spending money. For example, red colour may also be an incentive to purchase in the case of impulsive goods. (Varga et al., 2014)

### **Smell and olfactory marketing**

As Krishna (2010) states, smell is a key sense of taste, so without smell things would taste very similar. Human can recognize up to 10 000 smells, so companies can look for unique smells which can be associated with their brands. But it is also important that the olfactory sensations are related to the visual ones. (Štibinger, 2010).

The choice of fragrance may not be as simple as it may seem. For example, you can't support the sale of sweets with chocolate scents. In shops on the bus stops, the aroma of coffee has proven as good support sales of tobacco goods. Next example is that in supermarket is bakery next to the entrance, because smell of pastries can stimulate feel of hungry. And customer with hunger will buy more foods than customer without hunger. (Vysekalová, 2014)

As stated by Štibinger (2010), there are two basic methods for applying olfactory marketing at the point of sale. The first method is the overall scent of the premises, which aims to create a connection of products or point of sale with positive emotions. The second concept is zoning, which is intended to attract attention to a specific place or product, or to neutralize unpleasant odours.

It is important to distinguish if the smell is primary or secondary attribute of the product. Primary means, that the smell is main reason for the purchase of the product (flowers, perfumes etc.). Secondary attribute is understood when consumers buy the product for other reason (not for the smell), for example furniture, peanut butter etc.). (Krishna, 2010)

### **Hearing and audio marketing**

Music in point of sale is a powerful emotional trigger and affects the perception of the store. The pace of music determines the speed at which the customer moves and purchases around the store (Boček et al., 2009). Also, Tellis (2000) noted that music can attract attention quick. The style of music can also change the perceived value of the good or services and can arouse feeling of esteem (Dollars and Sense, 2009). Boček (2009) states that marketers use music in point of sales to promote identity of companies and evoke a certain atmosphere. Music affects the perception of time, so the right choice encourages customers to spend more time buying and



vice versa. The amount of money spent on purchases is then influenced by whether the customer knows the music background or not.

Research at the University of Leicester has shown that while playing purely French music in the supermarket, sales of French wines have increased, while the purchase of German Riesling has increased with a typical German brass band. (Lindstrom, 2009)

Sound is also an important aspect of many consumer experiences, and while typical of a particular activity, it can also make it unique to a particular brand or product. For example, Harley Davidson motorcycles can be distinguished by the unique sound of the engine. For several years, Kellogg's dealt with the sound of their cereal crunching to make every child distinguish this product from their competitors. In these cases, it is about incorporating the senses into the branding (sensory branding) (Lindstrom, 2010). Sounds shouldn't be ignored by marketers. Specific sounds are associated with specific products. If sound is an important part of product, it must be used in communication. If not, it is advisable to use music and sounds as a communication supplement. (Lindstrom, 2005)

### **Taste and gustative marketing**

Taste is the least independent sense. Indeed, the taste receptors are largely linked to the olfactory ones as mentioned above (Štibinger, 2010). Main target of marketing (based on taste) is increase quality of product and create new sources of inspiration, which will affect the imagination and consumer taste experiences. Gustative marketing mainly concerns food products and marketers use them almost exclusively in tasting events. (Boček et al., 2009)

Vysekalová (2014) noted that tastings can be counterproductive, because if a customer satisfies their taste needs at the point of sale, then they can be demotivated from satisfying tastes on the way from the shop or at home. Also, taste is an important part of, for example, cosmetic and hygiene products which are intended to be consumed by or near the mouth. According to Underhill (2009), up to 90% of all new food products will not be successful, because consumers don't have option to taste the new product. Taste is also associated with colours. Different tastes are matched with different colours, for example, red and orange are 'sweet', green and yellow are 'sour' and white is 'salty'. (Lindstrom, 2005)

### **Touch and tactile marketing**

Tactile has the advantage over other senses that its stimulation is not in one or two places, but throughout the body (Hulten et al., 2009). In contrast to sight or hearing, which have specific and limited receptors (Krishna, 2013). For example, Lindstrom (2005) states that when buying a car, they often kick the tires to see if they have the right hardness. It is a long-used quality test, or rather an action triggered to personally test tire quality. This sense is most important at the point of sale where is direct contact with place (tables, stands, shopping trolleys, seats, chairs, bank counters, etc.) (Boček et al., 2009).

Lindstrom (2009) states that shapes and materials of products are very often remembered, so it can be inferred that the distinctive shapes (edges etc.) are easier to recall later. Still, touch is the least important sense for purchase decision. Boček (2009) noted, that the touch of a product and its grip becomes a very important in the purchasing process. The ability to touch brings the customer closer to the product or shop. As Krishna (2010) points to Peck's research, which suggests that there are four main reasons for touching in purchasing process. The first is purchase of the product (putting goods from the shelf to the basket). Another reason is taking the product into hand to find out the information on the packaging or examining the properties of the product. And the last reason is fun or some expected sensory experience. Peck calls it a hedonic touch that hides the potential for use in in-store communication. In another research, Peck found that a customer who had a chance to touch a product is more willing to pay for it

than customer who had no chance to touch the product. This can be key information for stores that are not based on self-service.

### **3 RESEARCH GAP AND OUTLINE OF THE RESEARCH**

Based on a literature review, it is found that the research gap is in addressing the factors influencing sensory marketing in non-food retail, because the most of research is focused on sensory marketing in food retail. Research objectives and main research questions were defined based on results of the literature review.

The main objective of the research is to define changes in the customers' behaviour using sensory marketing tools in non-food retail. Research will address how the senses (smell, touch, sight, hearing, taste) of customer are stimulated to purchase product in non-food retails. It will also focus on how the senses work in the purchasing process individually or together. Thanks to results of research we will know, which senses are important in purchasing process and which not.

Research questions are:

- 1) Which senses influence customer behaviour in non-food marketing?
- 2) Is there a difference between individual sensory marketing tools and multisensory marketing tools?
- 3) How will the behaviour of non-food retail customers change when using sensory marketing?

#### **Methods of the research**

**1) Analysis of theoretical knowledge published in professional monographs, serials and other sources:** The essence will be critical literary review focused on available knowledge of emotional marketing, sensory marketing and multisensory marketing in food and non-food retails. An integral part of the literary review will deal with typology of retail companies and the definition of key types of non-food retail companies.

**2) Qualitative research by observation and personal interview with customers of non-food retail:** Primary data collection for qualitative research will be realized by observing during experimental research of using tools of sensory marketing in natural retail environment. Then will be individual interview with customer after purchasing process. The research will be a long-term and will be divided to phases. Every phase will deal with different sense, if same sense (environment will be different to know how sense will act with other stimulus). Data will be collected from customers of non-food retails.

**3) Qualitative research by individual interview with managers of non-food retail:** Primary data collection will be realized by individual interviews with managers of retails. Main goal will be to find out their experiences with tools of sensory marketing.

**4) Quantitative research of customers of non-food retail:** Last step will be quantitative research with customers to find out last important information for research results. Finally, will be performed synthesis of knowledge aimed at changing the behaviour of non-food retail customers using sensory marketing. The intended procedure of the work and methods in carrying out the research are shown graphically below.

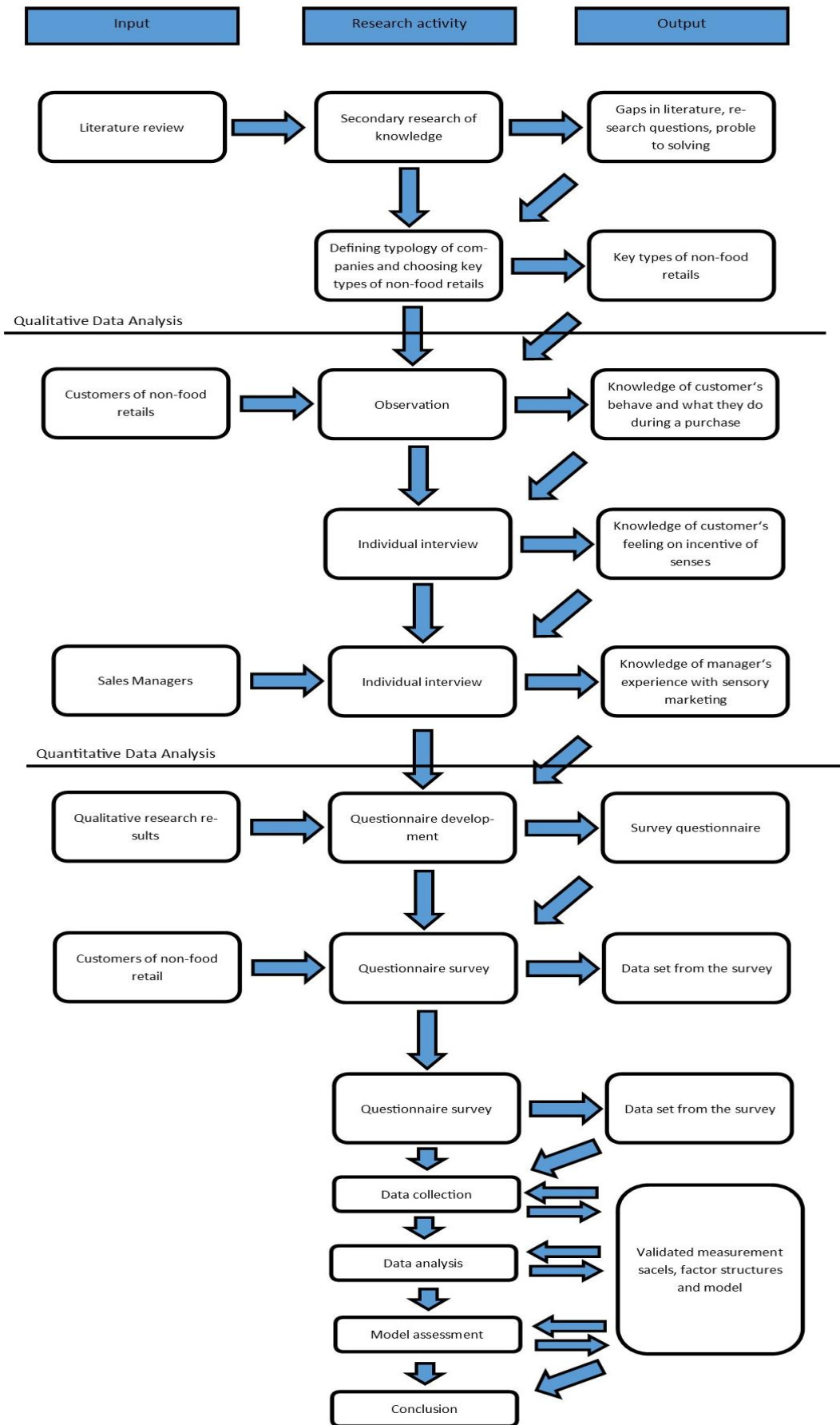

Fig. 1 – Intended procedure of future research. Source: own research

## 4 CONCLUSION

Future research dealing with the application of sensory marketing in non-food retail seems to be interesting in terms of benefit for theory and for practice. Basic gap in current researches is missing knowledge of using sensory marketing in non-food retails, which can lead to increase marketability, to more revenue and to more customer visiting shops (customers will come back because in shop is pleasant environment for them). It is very important to define key factors influencing sensory marketing in non-food retail. Very important are limitations of research. Main prerequisite for the implementation of unbiased research is human (seller), his behaviour, attitude to customers and mood can influent environment in shop and can influent merchantability of goods. That means in research it should be chosen these shops, which offer similar prerequisites for research (sellers should have similar knowledge of range of goods and similar attitude to customers). Next limitation is type of shops, where will sensory marketing used, because each type has different types of customers, different types of goods (to different types of goods corresponds different smell, music style, colours etc.). Another limit may be quality of the technical equipment, which is used for measurement the intensity of music, scent and other technical equipment for realization of research.

Whereas the author of this paper is on the beginning of PhD. studies, is main target of the paper is to emphasize the complexity of the whole issue of sensory marketing in non-food retail, to present an outline of future research with regard to the objective of the research, research questions and limitations.

### References

- Boček., M., Jesenský., D., & Krofiánová, D. (2009). *Pop - In-store komunikace v praxi: trendy a nástroje marketingu v místě prodeje*. Praha: Grada.
- Géci, A., Nagyová, L. & Rybanská, J. (2017). Impact of sensory marketing on consumer's buying behavior. *Potravinářstvo Slovak Journal of Food Sciences*, 11 (1), 709-717. doi: 10.5219/835
- Hulten, B., Broweus, N., & Dijk, M. (2009). *Sensory marketing*. New York: Palgrave.
- Krishna, A. (2010). *Sensory marketing: research on the sensuality of products*. New York: Routledge.
- Lindstrom, M. (2010). *Brand sense: sensory secrets behind the stuff we buy*. New York: Free Press.
- Lindstrom, M. (2009). *Nákupologie: pravda a lži o tom, proč nakupujeme*. Brno: Computer Press.
- Lindstrom, M. (2005). *Brand sense: build powerful brands through touch, taste, smell, sight, and sound*. New York: Free Press.
- Pradeep, A. K. (2010). *The buying brain: secrets for selling to the subconscious mind*. Hoboken: Wiley.
- Shabgou, M. & Daryani, S. M. (2014). Toward the sensory marketing: Stimulating the five senses (sight, hearing, smell, touch and taste) and its impact on consumer behaviour. *Indian Journal of Fundamental and Applied Life Sciences*, 4 (1), 573-581. Retrieved from <http://www.cibtech.org/sp.ed/jls/2014/01/jls.htm>
- Štibinger, A. (2010). Vůně jako nástroj smyslového marketingu. *Brands&Stories*. 4(1), 23.
- Tellis, J. G. (2000). *Reklama a podpora prodeje*. Praha: Grada.

- Underhill, P. (2009). *Why we buy: the science of shopping*. New York: Simon.
- Vysekalová, J. (2014). *Emoce v marketingu: jak oslovit srdce zákazníka*. Praha: Grada.
- Vysekalová, J. (2012). *Psychologie reklamy*. Praha: Grada.

### **Contact information**

#### **Ing. Michael Fafílek**

Tomas Bata University in Zlín, Faculty of Management and Economics

Mostní 5139, 76001, Zlín, Czech Republic

E-mail: m\_fafílek@utb.cz

ORCID: 0000-0003-1737-6293

doi: 10.7441/dokbat.2019.025

# ANALYSIS OF SELECTED FACTORS INFLUENCING THE SAFETY OF OVERSIZE TRANSPORT

*Teresa Gajewska, Anna Grabarz*

## **Abstract**

Safety is one of the most important aspects of regarding orders for transport in oversized freight forwarding. The logistics process regarding the organization of such a carriage is a long and complicated task. The aim of the paper is to propose to extract factors that affect the safe passage of non-standard vehicles. The analysis is limited to distinguishing factors that ensure safe transport only by road transport. The content of the paper was additionally limited to the subject of transport in Poland. The problem of oversized transport is presented on the basis of the Megatransport program and the analysis of selected orders of the transport company Miś. In order to determine the factors affecting transport safety, loads with different parameters belonging to category VII were analysed. Getting to know the subject of oversize transport, legal regulations and analysis of individual elements on the route made it possible to determine that at each stage of the process, i.e. during its planning, organization and at the crossing itself, factors influencing safety can be extract. For example, a proper choice of means of transport for oversized cargo or a choice of route for a vehicle with this cargo was distinguished. Systematic recognition of factors affecting the oversized safe crossing will reduce the risk of dangerous road situations. Paying particular attention to individual activities performed in order to ensure safety could eliminate potential threats.

*Keywords: road transport, oversize transport, safety issue, factors analysis*

## **1 INTRODUCTION**

Guaranteeing the safety of goods transport is one of the basic obligations in oversized freight forwarding. In the case of a specialized group of oversize transport, this is as important as a difficult task. In road transport, safety is influenced by many factors that relate not only to organizational activities, but also to legal requirements and infrastructure. Safety aspects should be remembered at every stage of the oversized transport process, i.e. during planning, organization and transportation. In case of oversized cargo, the cargo securing usually depends on the type and dimensions of the load. In order to minimize the risk of threats, each organized transport should be approached individually (Juściński, 2017). The load during transport should be properly distributed in the cargo space, fixed and secured to maintain stability, as this affects its safety during transport (Prochowski & Żuchowski, 2016). Regarding it comes to the safety of the whole process, it should first be emphasized that a very important and responsible task is to choose the means of transport that will be able to carry the load. It is equally important to set the right route that the oversized vehicle will be able to overcome (Juściński, 2016). In order for the vehicle to be able to carry out oversize transport, it is necessary to apply for an appropriate permit, and after obtaining such a permit, it is necessary to follow the recommendations contained therein. In order for the transport to be fully secured it is also necessary to provide the appropriate number of pilots. The carriage stage itself should be monitored and monitored at all times. Loading and unloading should be in accordance with the instructions of the organizer and manufacturer of the load, so that it is not damaged. Properly organized oversized transport should take place as planned, on time and safely.

The main aim of the presented paper is to select factors that have an impact on safety of transport in the field of oversized loads in road transport. Research has been limited to case studies in Poland. The analysis covers three stages of the transport process: planning, organization and carriage, because each of them carries out activities that directly affect cargo safety. In addition to analysing activities also taken into account legal regulations and basic restrictions of road infrastructure in Poland. The necessity of research in the area of oversize transport safety is aimed at minimizing the risk of dangerous situations during transit and eliminating the possibility damage to load.

## 2 THEORETICAL BACKGROUND – SAFETY IN THE OVERSIZE TRANSPORT PROCESS

Oversized loads are a group of various types of loads characterized by very large dimensions, i.e. parameters. For their transport, it is necessary to use special means of transport (Barcik, 2015). The term oversize vehicle, defined by Polish law (ISAP, 2009-2020c), defined these vehicles. Formal and legal conditions regarding the transport of oversize loads are documents specifying the conditions of transport. Legal acts, including laws and regulations regarding non-normative transport in Poland are: (a) Rozporządzenie z dnia 31 grudnia 2002, (b) Rozporządzenie z dnia 22 czerwca 2012, (c) Rozporządzenie z dnia 28 marca 2012, (d) Rozporządzenie z dnia 23 maja 2012, (e) Rozporządzenie z dnia 30 grudnia 2002, (f) Ustawa z dnia 18 sierpnia 2011, (g) Ustawa z dnia 21 marca 1985, (h) Ustawa z dnia 6 września 2001 (ISAP, 2009-2020a). Among all legal regulations, the law regulating the division of transport into VII category should be highlighted due to the different parameters of non-normative vehicles. The legal protection also applies to provisions regarding the consequences of an abnormal journey without a permit or a journey inconsistent with the conditions set out in the permit (ISAP, 2009-2020c).

In Poland, the quantitative situation of oversize road transport is illustrated by the number of permits issued, shown in Figure 1 (ISAP, 2009-2020d). Despite the significant decline in recent years, these are still large numbers of journeys that participate in road traffic. Ensuring the safety of their carriage is very important not only for the transport of goods, but also for other road users.

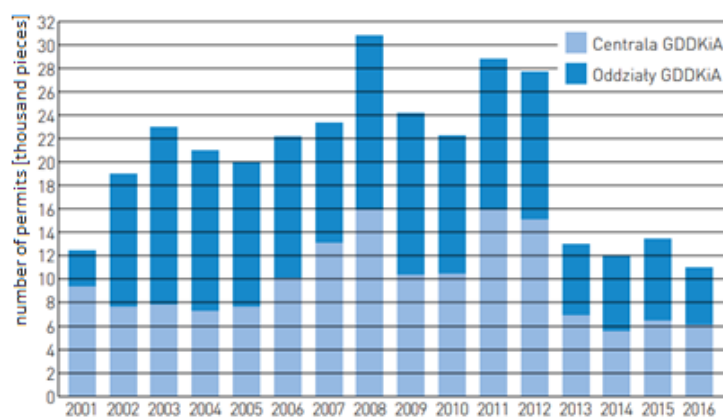

Fig. 1 – Number of permits issued for oversize journeys in the years 2001-2016. Source: Juściński (2017)

As the figure above shows, over 10,000 oversized transport takes place each year, which has an impact on road safety. The organization of this process should be properly prepared and secured to minimize the risk of dangerous situations. The processing of oversized cargo transport is a multi-stage and complicated logistics and forwarding task. The first stage is planning, where you should become thoroughly familiar with the specifics of the load, and then

select the appropriate means of transport based on its dimensions. Another task is to map the route taking into account parking spaces - possible to be implemented by a non-standard vehicle. When planning the route, first of all attention is paid to such elements of the infrastructure that may pose difficulties on the road, e.g. bridges, viaducts, low values of bends, curves of roads, technical condition of the road surface, objects located directly on the road or in the communication row, lines traction, power, and telephone lines suspended above the road (Galor, 2011). Any such element can be very dangerous for the implementation of oversize transport. Planning tasks should also include a plan for the distribution of cargo in the cargo space and the method of its attachment. The transported load must be properly secured so that it is not damaged during transport. Incorrectly securing the load to the vehicle may endanger the safety of the transported load as well as the environment and bystanders (Galor, 2011).

As for legal factors - the transport organizer is obliged to submit an application for permission to transport in the appropriate category. After obtaining the appropriate document, follow its recommendations. In some carriage, an escort of pilots is required, which is regulated by regulations (ISAP, 2009-2020b). Pilots are a very important element during transport, which is why the regulations regulate not only the conditions of their presence, but also the requirements for their marking. Loading, carriage and unloading are activities directly related to transport; therefore, their correct implementation directly affects the safety of the load and the entire process. The aim of the transport operation is the safe transportation of cargo, taking into account the safety of people and other road users, as well as the vehicle itself (Galor, 2011). Safety is "a state of not endangering certain goods and road safety is a formally established set of guarantees causing a traffic participant not to endanger his goods" (Rajchel & Wieczorek, 2000). Safe transport of oversize cargo is therefore a process that should take place without exposing other road users and the vehicle itself to dangerous situations that can lead to hazards such as collisions, damage and even destruction of the load. Safety transport is a prerequisite for full and timely delivery. In connection with the above, the main aim was adopted, which is an attempt to isolate factors affecting the safety of the non-normative transport process.

### 3 METHODOLOGY FOR PLANNING THE OVERSIZE TRANSPORT

In order to achieve the set aim goal, test procedure was proposed, that it is given in Figure 2.

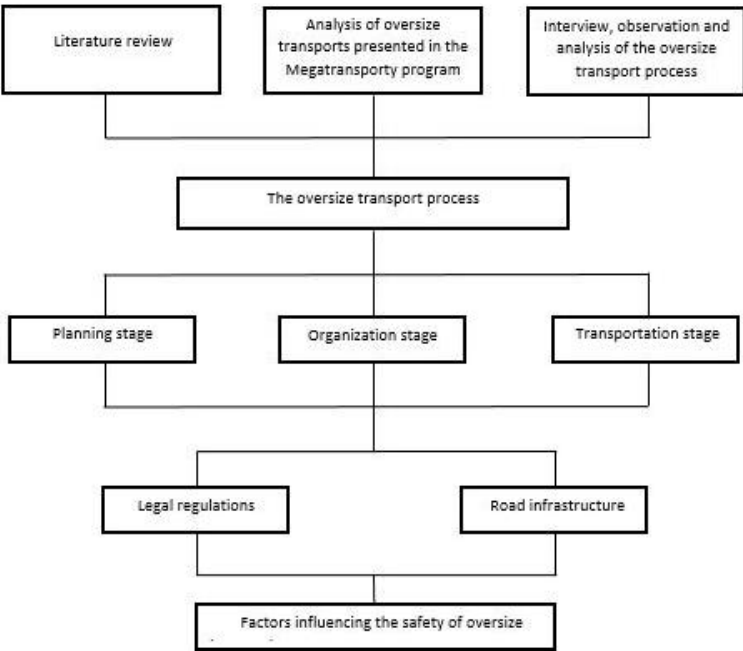

Fig. 2 – Procedure of conducted analyses. Source: own research



Specifying the factors that directly affect the safety of travel required a review of the literature and analysis of oversized transports carried out in the Megatransporty program (TVN Turbo, 2018) and by the MIŚ company. To have a full overview of the oversize transport situation, two different types of cargo were selected for analysis. The selection concerned significant exceedances of parameters such as: length, width, height and weight. The analysis concerned activities at the planning, organization and transport stages. The research factors relate not only to the tasks performed at individual stages but also to legal regulations and infrastructure.

In the Megatransporty program (TVN Turbo, 2018), the load of the refinery element 39.5 m long, 3.9 m wide and 3.6 m high was selected for analysis. The weight of this load is 94 t. After choosing the right means of transport, the transport set will be 47 m long, 4.6 m high and the width will remain unchanged. The mass of the oversized vehicle with the load is 134 t (Fig. 3).

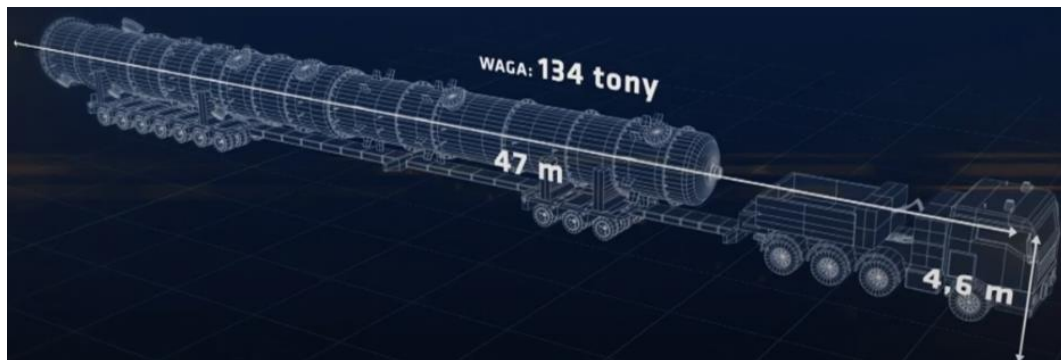

Fig. 3 – Parameters of the transport set with the load. Source: TVN Turbo (2018)

Such a long and heavy load is a serious challenge for the company transporting it. The choice of the means of transport concerned a vehicle whose lifting capacity allowed for transporting such a heavy load. The tractor selected for this task had 700 hp. The loading of the load required the use of two cranes, and mats, supports and chains were needed for fastening and securing. It was very important to position evenly the supports so that the load was stable, because with such a mass its incorrect attachment could not only damage the load but also the semi-trailer. Infrastructure restrictions for such heavy loads are mainly bridges, due to pressure restrictions and some roads. An additional difficulty is the poor condition of the surface of many roads in Poland. For long cargo, there are many more obstacles on the road. All manoeuvres that a long non-standard vehicle must make are usually controlled from the front and back by pilots. In addition, the crossing of the intersection and roundabout takes place during closed traffic. The processing of the transport task by MIŚ concerned a waste oil tank. The parameters of the transport set with the load are: length - 24.5 m, width - 4.70 m, height - 4.60 m, total weight - 40 t (Fig. 4)



Fig. 4 – Parameters of the transport set with the load. Source: MIŚ Transport (2019)

For the example of the refinery element load shown in Figure 2, activities have been identified that affect safe passage for loads that exceed the allowable value: width and height. Starting from the planning stage - the first very important task is to select a tractor and semi-trailer for such a wide and high load, and then to place the load and determine the centre of gravity in the cargo space. This is necessary because of the stability of the load during transport. It is equally important to fasten it during transport. If the load was incorrectly placed or secured it could fall out of the semi-trailer. Considering the height, which is a big limitation in the point infrastructure, appropriately low semi-trailers are selected so that the entire non-standard vehicle with the load is as low as possible. Mapping the route is a very complicated task regarding knowledge of the road network and infrastructure restrictions. When carrying out this task, the first obstacle appeared already at the exit from the production plant. It turned out that the vehicle and load were too wide to fit in the gate. Another problem was driving the narrow streets, which had to be closed from two sides for the vehicle to fit. For wide oversized vehicles, islets with vertical signs have also proved to be a significant obstacle. In order for the vehicle to be able to carry out its sentence, such signs had to be dismantled in each case. On the route, a narrow bridge was also an equally dangerous place, which had to be closed during the journey because the vehicle occupied two lanes. Restrictions due to the height of the load concerned, among others, passage under overpasses. Equally difficult was the street where tall trees grew from two sides and their branches stuck out above the road. Often, very high loads also have a problem with passing under power lines, telephone traction lines and lamps located in close proximity to the road. To meet the formal and legal requirements, a category VII travel permit was obtained. One of the requirements was the escort of two pilots who were to ensure road safety during the implementation of the transport task. The ride itself was very well planned and prepared, and was preceded by a local vision. The load was loaded and secured using tools after checking their technical condition and attestations. The carriage was escorted by pilots and constantly monitored by employees. During unloading the driveway, extreme caution was exercised and the load was removed from the vehicle while observing all safety rules. During transport, the entire crew avoided all dangerous situations and reached their destination safely by following previous recommendations.

#### 4 ANALYSIS FACTORS INFLUENCING THE TRANSPORT OF THE OVERSIZE CARGO

The theoretical analysis of the planning, organization and transport process, as well as specific examples, showed that at every stage you could distinguish activities that affect the safety of oversized passage. The research showed that everything depends on the size and type of load. The activities carried out at the planning stage affect the organization of the process. However, appropriate organization is the basis for the implementation of transport. The study and familiarization with the basics of oversized transport allowed for the specification of several main aspects affecting safe transport. These factors were formulated and presented in the diagram below, due to their extensive tasks during the transport process.



Fig. 5 – The division of tasks of the transport process. Source: own research

It should be noted that each task of organizing the transport of oversized loads, especially in the case of very large dimensions, should be approached individually, and the slogans presented may be only a hint on what to pay special attention to. More detailed tasks that are performed at individual stages of the transport process are described in Table 1. These activities are factors that affect the safety of oversized transport.

Tab. 1 – Implemented tasks in the process of transporting oversized cargo. Source: own research

Planning stage	Choice of means of transport	The means of transport should be selected according to the size of the transported load.
	Load arrangement and fixing method	Planning the position of the load in the cargo space and choosing the method and tools needed for fastening and securing.
	Mapping the route	Planning a route that can be implemented by an oversized vehicle, including parking spaces.
Organization stage	Permits	Submission of the application and permission to drive the appropriate category.
	Pilotage	Organization of an appropriate number of pilots necessary for carrying out the transport task.
	Technical Support	Organization of a team to solve technical tasks on the road such as dismantling signs.
Transport stage	Loading	Loading should take place according to the previous plan, using appropriate means and tools.
	Transport	Oversized transport should be monitored and controlled at all times.
	Unloading	Unloading goods should be carried out in accordance with the plan that was previously prepared.

In order to structure the work on the safety of oversized carriage, one should pay attention to the appropriate selection of a semi-trailer or trailer to the dimensions of the load, and then select the tractor to implement the sentence. Mapping the route is primarily associated with infrastructure restrictions, which can include bridges, viaducts, tunnels, flyovers, junctions, roundabouts, vertical signs, arc and corner radius values, poor condition of the road surface, power, traction and telephone networks (lines) suspended over roads (Galor, 2011).

Planning a route involves avoiding obstacles on the road. Very often, the designated routes are much longer; however, the possibility of dangerous situations on the road caused by infrastructure elements is maximally limited. When planning long routes, you should also remember to designate a place for stops that will not be an obstacle for the transport set. The arrangement of the load in the cargo area, it is fastening and securing are further activities that affect transport safety. To this end, the technical condition of tools used for this purpose should be checked so that they do not break down during heavy loads in transport. Approval must be obtained for transport to be carried out. In addition, during the transport itself, you must comply with the requirements contained in it, which will affect road safety. For category VII, mention may be made of, among others pilotage, night time travel, and significant speed restrictions especially on bridges. In order for the journey to be carried out as required, it should be monitored and controlled at all times. This will increase security.

## 5 CONCLUSION

The theoretical issues presented in the paper and the analysis of the transport process of non-standard vehicles presented for the example of orders from the Megatransporty program and MÍŠ company have allowed to extract the factors that affect safe carriage. Factors that have been distinguished relate to activities at the planning, organization and transport stages. At the

first stage, it should be emphasized that safety is influenced by the choice of the means of transport to the size of the load and planning the route appropriate to the parameters of the oversized vehicle. Remember also to check the technical condition of the vehicle before setting off on a route. In addition, the distribution of the load should always be laid out in the vehicle's cargo space and the method of its attachment so that it is not damaged. The organization of the process mainly concerns the submission of an application for an appropriate toll permit, which includes the conditions relating to its road safety. If the size of the load is considerable, remember to organize the appropriate number of pilots. The transport stage should be monitored and controlled at all times. In addition, it should be noted that each task should be performed carefully and precisely, because it has a direct impact on the next action. Paying special attention to the above-mentioned activities in relation to the safety of passage, allowed emphasizing their importance, and thus minimizing all types of threats occurring during the implementation of transport. Systematizing the factors responsible for safety will minimize the risk of unsafe situations. The conclusion is that the isolation of factors described in the paper will increase transport safety.

## References

- Barcik, R. (2015). Uwarunkowania transportu ładunków ponadgabarytowych transportem samochodowym. *Logistyka*, 2015(2), 28-35. Retrieved from <https://www.czasopismologistyka.pl/artykuly-naukowe/send/328-artykuly-na-plycie-cd-1/7293-artykul>
- Galor, W. (2011). *Carriage and Securing of Oversize Cargo in Transport*. Szczecin: Akademia Morska.
- ISAP. (2009-2020a). *Internetowy System Aktów Prawnych*. Retrieved from <http://prawo.sejm.gov.pl/isap.nsf/home.xsp>
- ISAP. (2009-2020b). *Rozporządzenie Ministra Transportu, Budownictwa i Gospodarki Morskiej z dnia 23 maja 2012 r. w sprawie pilotowania pojazdów nienormatywnych*. In: ISAP – Internetowy System Aktów Prawnych. Retrieved from <http://prawo.sejm.gov.pl/isap.nsf/DocDetails.xsp?id=WDU20120000629>
- ISAP. (2009-2020c). *Ustawa z dnia 18 sierpnia 2011 r. o zmianie ustawy - Prawo o ruchu drogowym oraz niektórych innych ustaw*. In: ISAP – Internetowy System Aktów Prawnych. Retrieved from <http://prawo.sejm.gov.pl/isap.nsf/DocDetails.xsp?id=WDU20112221321>
- ISAP. (2009-2020d). *Ustawa z dnia 21 marca 1985 r. o drogach publicznych*. In: ISAP – Internetowy System Aktów Prawnych. Retrieved from <http://prawo.sejm.gov.pl/isap.nsf/DocDetails.xsp?id=WDU19850140060>
- Juściński, S. (2017). *Zagrożenia i szanse rozwoju rynku przewozów ponadnormatywnych: Dole i niedole polskich ponadgabarytów*. Retrieved from [http://www.transport-manager.pl/wp-content/uploads/magalone/esta\\_pl/pdf/full.pdf](http://www.transport-manager.pl/wp-content/uploads/magalone/esta_pl/pdf/full.pdf)
- Juściński, S. (2016). *Logistyka transportu ładunków nienormatywnych*. Lublin: Libropolis.
- MIS Transport. (2019). *MIS transport draft*. Retrieved from <https://www.youtube.com/watch?v=S8N0sF4MgeU>
- Prochowski, L., & Żuchowski, A. (2016). *Technika transportu ładunków*. Warszawa: Wydawnictwa Komunikacji i Łączności
- Rajchel, K., & Wieczorek, S. (2000). *Wypadki drogowe w świetle badań*. Rzeszów: Erwico.

TVN Turbo. (2018). *Megatransporty*. Retrieved from  
<https://player.pl/programyonline/megatransporty-odcinki,4707>

### **Contact information**

#### **Teresa Gajewska, Ph.D.**

Cracow University of Technology, Faculty of Mechanical Engineering  
Al. Jana Pawła II 37, 31-864 Cracow, Poland  
E-mail: [teresa.gajewska@mech.pk.edu.pl](mailto:teresa.gajewska@mech.pk.edu.pl)  
ORCID: 0000-0001-6858-4274

#### **Anna Grabarz, Eng.**

Cracow University of Technology, Faculty of Mechanical Engineering  
Al. Jana Pawła II 37, 31-864 Cracow, Poland  
E-mail: [anna.grabarz5@gmail.com](mailto:anna.grabarz5@gmail.com)  
ORCID: 0000-0002-2308-8127

doi: 10.7441/dokbat.2019.027

# CHARACTERIZATION OF PEDESTRIAN AND MIXED STREETS AND ITS INFLUENCE IN FREIGHT ACTIVITIES

*Juan Carlos Gómez, María Victoria de la Fuente, Lorenzo Ros*

## **Abstract**

The city features and the predilection for shoppers to be located in the centre of the cities, have a significant influence on the way in which the orders have to be dispensed, especially since the deliveries are made according to the demand. For this reason, it is relevant to study the influence of the logistics distribution areas depending on the type of street to which they supply. In order to provide a delivery behaviour model based on urban typology, the research team has delimited a study area located in the historic centre of the city of Cartagena (Spain). A methodology has been proposed to characterize the existing streets under study as well as to determine the correlation between the activity of a specific freight area with its area of influence. Finally, considering the results, it can be mentioned that the authorities do not follow any criteria for pedestrianizing streets taking into account the commercial level of the area, which turns out in the progressive closure of stores located in secondary streets, also it can be confirmed that freight zones located in prime areas have a close relationship with the establishments that they supply, the secondary zone shows an anomalous behaviour and the tertiary zone is not affected by the primary zone since the levels of demand are much lower and far from them. To conclude, the current problem and the design of particular solutions that can be inferred to other cities will be raised.

*Keywords: urban freight distribution, sustainable transport, type of streets, city centre*

## **1 INTRODUCTION**

The 2030 Agenda established seventeen sustainable development goals in order to meet social, economic and environmental challenges of globalization, one of them being sustainability (WCED, 1987). Based on the premises with which this objective was written, the European Commission pointed out that information, mobility and energy must be connected in order to achieve common objectives that are environmentally friendly. Focusing on the concept of sustainability in the urban field, particularly in European cities, the corresponding administrations are taking actions on urban planning (Harris, 1994), acting on operators with different ideas and objectives, although all with the common aim: the system working efficiently (Taniguchi et al., 2001).

Currently, there is a clear trend towards increasing pedestrian areas in the city centre with numerous restrictions on logistics activities (Herrera, 2012). Highlighting the case of Mediterranean cities, we find small-sized urban centres with complex planning that must provide parking to private vehicles which want to access the centre as well as to the distributors who need to operate in the loading and unloading areas nearby to the population centre (Muñuzuri et al., 2016). In this sense, both the exponential growth that the electronic commerce is experiencing in the last decade (Russo, Polimeni & Comi, 2008; Herrera, 2016) and the requirements of businesses to be supplied according to the demand for not having large warehouses are taking into account; all that, since in order to reduce the negative impacts that urban logistics may have on pollution levels, the administration must consider the need to propose strategies to optimize the operation of freight activities (Taniguchi & Thompson, 2015). That is why there is a need to study the influence of freight activities in urban areas

depending on the types of establishments present, in order to propose solutions that improve service and reduce conflicts between the different groups of actors involved (Dablanc, 2007). As a way of getting healthier environments, the aim of this communication is to propose premises to ubicate loading and unloading areas with the purpose of minimizing the costs for logistics companies depending on the type of the street where they are located. The research team proposed the following objectives in a delimited area of study: (1) Classifying the streets under the study basing on commercial variables, pedestrian flow and attractiveness. (2) Analysing the behaviour of the dealers in the loading and unloading areas during a time window and determining the influence area for every loading and unloading areas. (3) Determining if the loading and unloading areas are well located and satisfying the needs demanded by the different types of streets mentioned previously.

Considering the classification of the area of influence as primary, secondary or tertiary, the research team proposes three groups of streets taking into account commercial diversity, administrative activities and provision of services, as well as the attractiveness of the area. Finally, to know if the loading and unloading areas that operate in primary, secondary or tertiary areas need to be modified according to demand, the correlation between the length and the distribution area of each of them has been obtained.

## **2 THEORETICAL FRAMEWORK**

Analysing the bibliography, there are articles where the behaviour of the dealers has been studied according to the distribution area, with and without temporary restrictions, depending on the type of establishment using multivariate statistical correlations (Monokrousou & Giannopoulou, 2016; Soni & Soni, 2016; Woudsma & Jensen, 2005). Some of them propose generic solutions for the location of freight activities in places of confluence seeking not to obstruct the existing traffic and doing this by grouping streets, since the establishments that predominate in it give rise to a certain configuration (Muñuzuri et al., 2017). However, it is not feasible to have numerous loading and unloading areas in urban centres, as they would quickly collapse at rush hours. Therefore, other authors advocate doing so in large areas (Woudsma et al., 2008; Alho & de Abreu e Silva, 2015). Taking into account the results presented in all these studies, which are related to the ideal location of loading and unloading areas and their influence on the development of merchandise activities, no distinction is made according to the type of streets and commercial activity that define the zone.

### **2.1 Characterization of urban areas**

The analysis of urban typology is a key factor in the impact of trade on logistics activities (Allen, Browne & Cherrett, 2012). Although new forms of business are constantly appearing or existing ones are evolving to new ones in order to attract public, the configuration of cities remains stable, being long-term when an adaptation of urban planning is perceived to the appearance of new needs (Fang et al., 2019). Numerous authors consider that changes in people's behaviour affect demand (Takahashi et al., 2005), being necessary to size the areas that supply the establishments with criteria according to commercial requirements. However, the impact of the number of streets and surrounding pedestrianized areas together with both social and urban factors must be taken into account; this being a limited field of study where not much literature is found (Chiquetto, 1997; Soni & Soni, 2016), but which significantly affects the operation of urban centres and the quality of life of people who use them (Yannis, Golias & Antoniou, 2016). The analysis of the behaviour of dealers in residential environments is reduced in the literature to three fields of study that basically analyse the imposition of time windows, the adoption of traffic restrictions (Schomaker et al., 2006) and the establishment of urban consolidation centres that reduce traffic (Morana, Gonzalez-Feliu & Semet, 2014).

From a general point of view, when defining urban areas, different criteria have been proposed that can be divided into three groups (Salom, Carrasco & Puebla, 2014): those that use indirect indicators to identify social and economic characteristics associated to the urban space; those that are based on the morphology of the city (density of built space, urban continuity, height of buildings and type of land), and those that focus on the relationships between nearby population centres (public and private transport, port or rail connections and tourism, among others). Miralles-Guasch and Tulla (2012) analysed the relationship between urban growth and communications networks, realizing that both variables are closely related. Establishing an analogy with the commercial areas, it is clearly obvious that the type of street where the shops are located will have a significant influence on their economic development (Sastre et al., 2013; Soni & Soni, 2016) and, consequently, it will cause a certain level of activity on the area, being economic empowerment one of the objectives that administrations want for the commercial areas of the cities (Gómez, 2000) in order to increase its attractiveness.

In numerous articles, the authors usually correlate morphological variables with social variables. Some of them go further and, taking into account the concern for environmental sustainability, consider that the urban landscape also affects the development of commercial activities (Silva & Rodríguez, 2015). A more exhaustive analysis based on social and morphological variables, such as population density, type of population, urban design and commercial level, allows us to distinguish three areas within urban areas (Fang et al., 2019): commercial areas, residential areas and historical centres. The main characteristics of each of them are shown in Table 1.

Tab. 1 – Characteristics of urban areas depending on the typology. Source: Ambientum (n.d.)

Type of zone	Population density	Commercial density	Area	Traffic	Access limitation
Residential	Medium	Medium	High	Medium/low	
Commercial	Low	High	Low	Medium/low	X
Historic center	Low	High	Medium	High	X

For example, Fang et al. (2019) aims to study the relationship between population density (because this variable is related to the commercial development of the area considered), the integration of services as well as the height and distance between buildings. To confirm the significant relationship between the specific variables, he uses statistics and multiple correlations with significant studies. It results in a direct relationship between the population density, social integration and density of the buildings in opposite to an inverse relationship between the density of the mobs and the width of the streets, in addition to the height of the buildings. This result is not striking if it is not treated together with that of integration, since, in the centre of the cities, it is characteristic that commercial areas are located in zones with tall buildings and multiple services (leisure, administration, food and so on).

Other authors consider that the characterization of commercial areas must be carried out taking into account only economic and social indicators. Alho et al. (2015) defines “point density” as a variable that considers indicators related to commercial density based on the number of establishments, sales and number of employees, and indicators based on needs (Dezi, Dondi & Sangiorgi, 2010). Likewise, authors such as Hass-Klau (1993) establish that the level of income and billing has an insignificant relationship, so there is a need to study other indicators that consider all businesses. That is the reason why an indicator associated with commercial homogeneity is defined similarly to the concept of entropy (Alho et al., 2015); it turns out that in those areas that have a greater homogeneity have a superior economic development. These indicators are those that the administration usually uses for sizing and finding merchandise areas in the centre of cities (Lindholm, 2013).



Based on the above information, it is evident that the impact of the commercial level of the area on logistics activities depends not only on the type of urban area, but also on the particular characteristics of each street, since this influence the delivery process resolution (Muñuzuri et al., 2017). Authors such as Palomares Borja (2015), also consider that the locations of retail stores in the city centres depend on the type of area of attraction (which may be primary, secondary or tertiary), the flow of pedestrians, the type of sidewalk and the environment (which involve the provision of existing services and the urban conditions of the environment). Therefore, for the definition of the area of attraction level, both commercial aspects and administrative and social aspects must come together.

## **2.2 Behaviour of dealers in commercial areas**

Once the urban typology is defined and the type of street is characterized, the behaviour of the distributors in the commercial areas must be analysed in order to establish the influence between all these variables. One of the ways to study the influence of commercial activities is based on the layout of maps influence. These are intended to show the scope of commercial activities on the map on the basis of the existing loading and unloading area (Ros et al., 2018). In order to determine these maps, the flows of merchandise and delivery movements must be obtained using data from the suppliers, from the administration or through a methodological proposal that allows them to be collected and analysed. These flows of movements, together with the locations and lengths of the freight areas, let us obtain behavioural patterns of the distributors, as well as the routes that they usually follow within the urban centres.

Taking into account that the ordinances constitute the normative base to regulate the distribution of goods (Muñuzuri et al., 2016); these rely on regulations of higher order that delimit the requirements to be met by the affected sectors. Each country legislates the minimum regulations to be met in relation to urban logistics; since most of the regions that compose it usually have similar social, economic and urban characteristics, the ordinances established by the municipalities are those that adapt these activities to the proper functioning of each city. It could be mentioned that some of the similar characteristics in Spanish cities are the following: (a) Urban centres with radial structure. High concentration of leisure areas, shopping and restaurants in the centre. (b) Most cities tend to grow around the historic centres, so the centres are usually narrow streets with limited parking areas. (c) Freight activities are normally perceived as a nuisance, and the administration is indifferent (Zunder & Ibáñez, 2004).

In general, the urban distribution of goods in Spain has been negatively affected by current regulations. In addition, most initiatives and regulations do not work due to the conflict of interests of users, lack of compliance with the ordinances and lack of foresight. Particularly, in pedestrian areas, the main constraints facing the distribution of urban goods are: (1) Inadequate parking areas in the vicinity of pedestrian areas due to poor urban planning, resulting in logistics companies finding loading and unloading areas occupied by private vehicles, lack of car parks or limitations due to external constraints. (2) Traffic in the transit areas of logistic routes. Logistics operators may find that the adjacent roads lead to the exit or entry of private vehicles into pedestrian areas, resulting in the removal of additional unloading areas. (3) Growth of cities. The increase in the number of cities has been made without attending to a plan of previous urban planning that took into account the logistics. (4) Restriction of vehicle access in certain areas. Legislation tends to restrict access to large vehicles, forcing logistics companies to use less efficient vehicles (Anderson, Allen & Browne, 2005). (5) Time windows are established limiting time parking few hours a day, so it is frequent the appearance of collapses in rush hours. (6) More frequent and small deliveries. Clothing or electronics companies often place numerous orders of small volume. (7) Wide variety of product types. Within the logistics in the cities, we can find delivery and collection of waste, delivery to retailers, etc.

The data collected in articles that study the strategies that the dealers follow when they access the urban centres propose the following premises (Oliveira, 2014; Muñuzuri et al., 2017): (a) Deliveries to shops are usually made before opening hours; it takes longer than 15 minutes. (b) The operation of freight areas reaches maximum levels between 9:00 a.m. and 11:00 a.m., descending during the afternoon. The delivery times start early in the morning in most establishments. (c) Small vehicles are usually used in order to manoeuvre and park faster. It is characteristic that, to access pedestrian areas, electric vehicles or pallet trucks are used to move heavy goods quickly. (d) The dealers do not usually walk more than 200 m to make deliveries; in that case, they look for parking areas in other locations closer to the delivery establishment.

### **2.3 Urban logistics in the city of Cartagena**

The city of Cartagena is located in the southeast of Spain. It occupies, at a distance of 48 km away from Murcia, one of the best ports of the Mediterranean Sea. The municipality has 215,418 inhabitants, according to its municipality as of January 1, 2019; they spread over a municipality of 558 km<sup>2</sup>. It can be seen how the main activities that are carried out in the city are those related to leisure, commerce, administration and business.

Cartagena is an eminently tourist city and its entire urban area is built in the immediate vicinity, specifically, in the historic centre of the city, where the main monuments are located. Consequently, the main administration buildings and financial offices may be found there. The port has led to the appearance of companies in the city that make use of the resources that reach it, such as: the transport of goods, oil or gas refinery, fertilizers, cement and maintenance of military ships. On the outskirts of the city, there are two large industrial estates where numerous industrial activities are carried out and supply the population and its surroundings.

The historic centre of Cartagena, with an area of approximately 1 km<sup>2</sup>, is characterized by having narrow streets with numerous establishments that have very small warehouses. These are supplied, periodically, several times a week. The City Council aims to improve the attractiveness of the city, and since 1995, several phases of pedestrianization have been proposed in order to adapt and remodel the main streets. From the beginning of the pedestrianization works, the Municipal Traffic Ordinance of the city collects authorizations for loading and unloading in pedestrian areas, in this sense, prohibiting access to these to any type of vehicle, except those for cleaning and emergencies.

However, the pedestrianization of the city centre has led to the appearance of numerous problems that not only affect the users in this area, but also on transporters. The large number of private vehicles trying to access the city centre significantly reduces the speed of traffic in the border areas, while intensifying the pressure on the available parking areas, in this way, generating frequent cases of inadequate parking. All problems related to freight activities in Cartagena have the following characteristics in the pedestrian zones and nearby areas: (a) Restricted entrance to the city centre from the beginning of the pedestrianization works. Since this moment, commercial vehicles need a special permit to enter the pedestrian zone. (b) Residents in the city centre use the private vehicle a lot, so there is an excessive use of loading and unloading areas at times destined for this purpose. (c) Pedestrian streets are very busy during the morning. It is for this reason that all commercial establishments have to stock up in a short period of 3 hours. In turn, it is in this time zone when pedestrians make great use of pedestrian areas, since they become transit areas for access to characteristic buildings (such as schools and offices). (d) The municipal ordinance limits parking in these areas to a maximum of 15 min. In general, these places are occupied by resident cars or by shop workers themselves.

During the exercise of the logistics activity in the urban area, specific congestions are observed at mid-morning between 8:00 a.m. and 11:00 a.m.; it turns out characteristic that the first consequences occur at the intersections of several pedestrian streets. Figure 1 shows the streets of Cartagena differentiating whether or not they are pedestrianized.

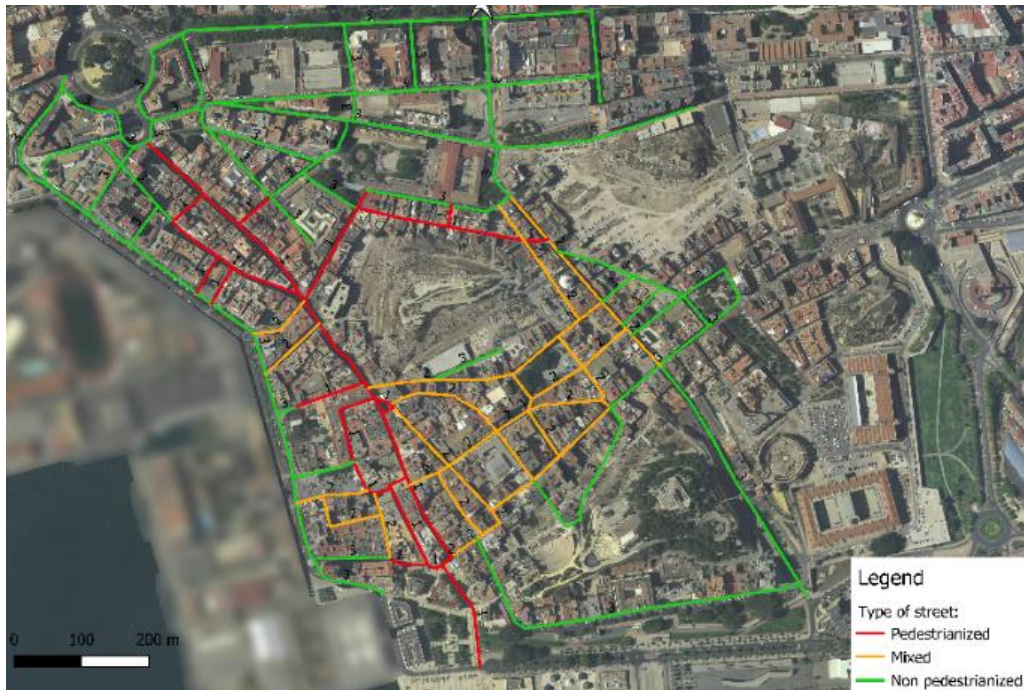

Fig. 1 – Type of streets that compose the historic centre of Cartagena. Source: own research

### 3 METHODS

As stated above, the aim of this communication is to propose premises to ubicate loading and unloading areas in order to minimize the costs for logistics companies depending on the type of the street where they are located.

#### 3.1 Delimitation of the study and classification of street type depending on commercial variables

The study area selected and included in figure 1 has more than 750 commercial establishments and a high population density (384 inhabitants/km<sup>2</sup>); also it has a wide of economic activities that generate freight flows that go from outside the city to the inner zone, and vice versa. Considering the classification of the area of influence as primary, secondary or tertiary, the results of the articles by Palomares Borja (2015), Sastre et al. (2013) and Soni & Soni (2016) will be used. Therefore, three groups that include the existing commercial diversity, administrative activities and provision of services, as well as the attractiveness of the area (depending on the number of pedestrians in the area to be considered) have been established. The teamwork has proposed the following premises to classify the street to be analysed as primary, secondary or tertiary.

Primary areas: it is the most frequented area of the city; it has numerous stores attending all of them to different social classes. The restrictions presented are: noise, traffic and pollution. Regarding the conditions we find: (a) Variety of stores that will meet the maximum needs (hygiene, beauty and health, home equipment, restaurants and services). (b) Strong attraction with large population or tourist attraction. (c) Existence of provision of services such as:

playgrounds, parking and public transport stations, among others. (d) Presence of entertainment and leisure activities or space for events. (e) Areas of high pedestrian transit.

Secondary areas: they are in the vicinity of the primary areas and are less frequented, so there is less quantity and variety of stores, as well as fewer consumers. The restrictions presented are the same as the primary zones. Tertiary areas: these are the furthest ones from the primary areas, being the least frequented. In these zones, there is no variety of shops and they are usually eminently residential areas. The minimum conditions that we find are: (a) Little variety and quantity of stores. (b) Low attractiveness and pedestrian flow. (c) Minimum provision of services.

However, the restrictions in tertiary areas are more stringent than in the previous areas and are the following: (a) It cannot meet all consumer needs. (b) Residents must go to the main or second zone to meet their needs. (c) Very limited provision of services related to bus or taxi stops.

Finally, the minimum conditions to be met by a pedestrian street will be established in order to compare whether the pedestrianized streets in the city of Cartagena meet these characteristics currently and, consequently, the administrations have to remodel them. These areas are reserved for the exclusive use of pedestrians and all road traffic is restricted; a large number of stores are concentrated in them and the behaviour of customers in these areas greatly influences the demand in addition to the traffic conditions exposed. As minimum conditions, these streets must present: (a) High security and concentration of stores. (b) Social space where people can do leisure activities. (c) These must have easy and accessible areas from public transport. (d) The streets require a high number of parking lots and services. (e) These areas are very busy by tourists. (f) Regulations are implemented to reduce pollution.

As a summary, the criteria that have been used to differentiate the streets according to their area of attractiveness are shown in Table 2.

Tab. 2 – Characteristics of primary, secondary and tertiary areas. Source: own research

Type of zones	Primary	Pedestrian	Secondary	Tertiary
Stores categories	4-6	6 or more	2-4	2 or less
Services categories	1 or	3 or more	1 or more	1 or less
Bar/Restaurant	4 or	4 or more		2 or less
Entertainment/leisure	X	X		
Amenities: Parking	X	X	X	
Pedestrian plateaus	X	X		
Pedestrian transit	Strong	Strong		Medium/weak

### 3.2 Obtaining distribution maps and influence of merchandise areas

The measurements related to the logistics activity have been taken in a time window from 8 a.m. at 11 a.m., since they have been searched in the most conflictive periods so that the solutions are applicable in the other periods of time with less activity. Although a large number of movements are also predicted in the afternoon, it can be observed in previous studies that the main activity happens in the morning (Ros et al., 2018); therefore, it is unnecessary to make measurements in the afternoon. Before collecting logistic data flows, the lengths of the marked freight areas within the study area were measured, resulting in 522 m and a total area of influence of 0.31 km<sup>2</sup>.

Once the data is available, the commercial area where it distributes is associated with each freight zone. The purpose of this association is to obtain the degree of correlation between the area of influence of the logistics zone and the length of each of these. All of this aiming at answering the question: if a primary, secondary or tertiary zone is increased, should the loading

and unloading zone that supplies it be resized? Because of this, the correlation coefficient and the regression line that relate both variables will be obtained (Fang et al., 2019).

### 4 RESULTS

Using the above methodology, the type of streets has been obtained taking into account the factors mentioned; in this way, detecting that there are prime areas that are not pedestrianized as opposed to pedestrian areas that are secondary. Depending on the pedestrian zone and considering the distinction of commercial sectors commented by Muñuzuri et al. (2016) (five sectors are distinguished: chemical, pharmaceutical and floral sector (1), metal processing (2), food, tobacco and beverages (3), other services (4) and fresh food (5)). We can see in Figure 2 the number of establishments that make up each zone, observing that there is a greater confluence of shops in the primary zone and, consequently, greater logistics activity.

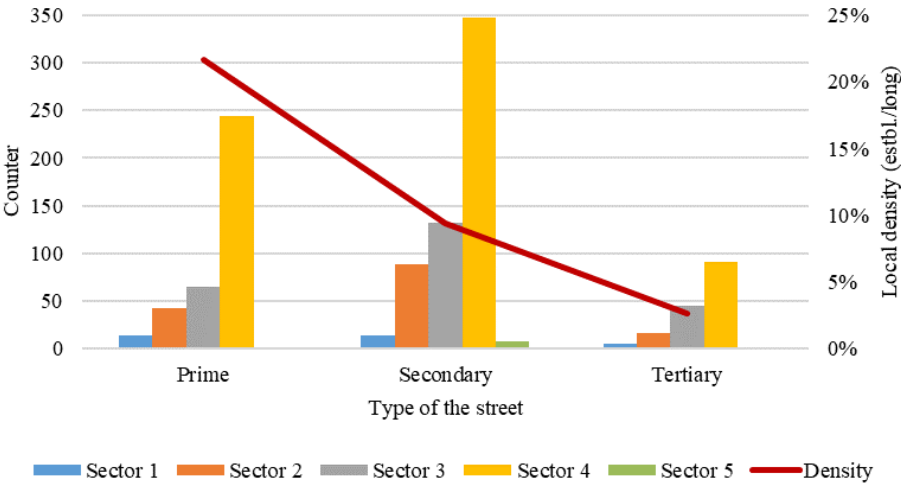

Fig. 2 – Retail distribution based on street type. Source: own research

Figure 3 shows the classification of streets according to the influence (primary, secondary or tertiary).

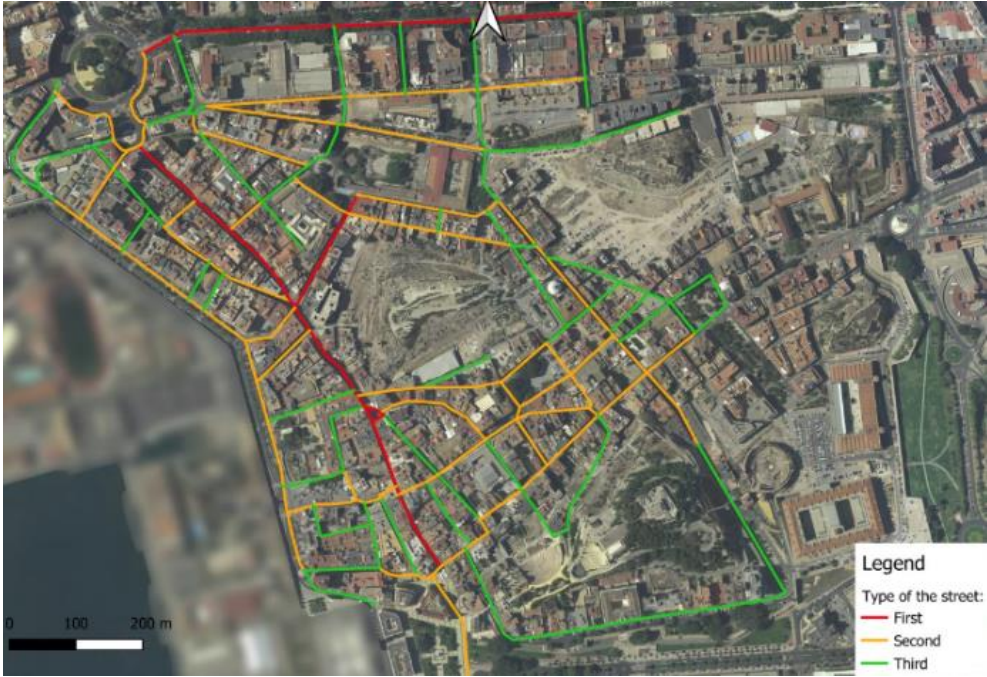

Fig. 3 – Classification of streets based on attractiveness. Source: own research



The influence of the different loading and unloading areas has been carried out on the basis of the present logistic flows. For this purpose, an influence map in which the scope of each of these areas has been collected has been obtained, and its results are collected in Figure 4.



Fig. 4 – Influence map of the logistics areas located in Cartagena. Source: own research

Finally, the loading and unloading areas are associated with the commercial zones, and the relationship between the loading and unloading length with its area of influence is obtained, getting the following results shown in Figure 5.

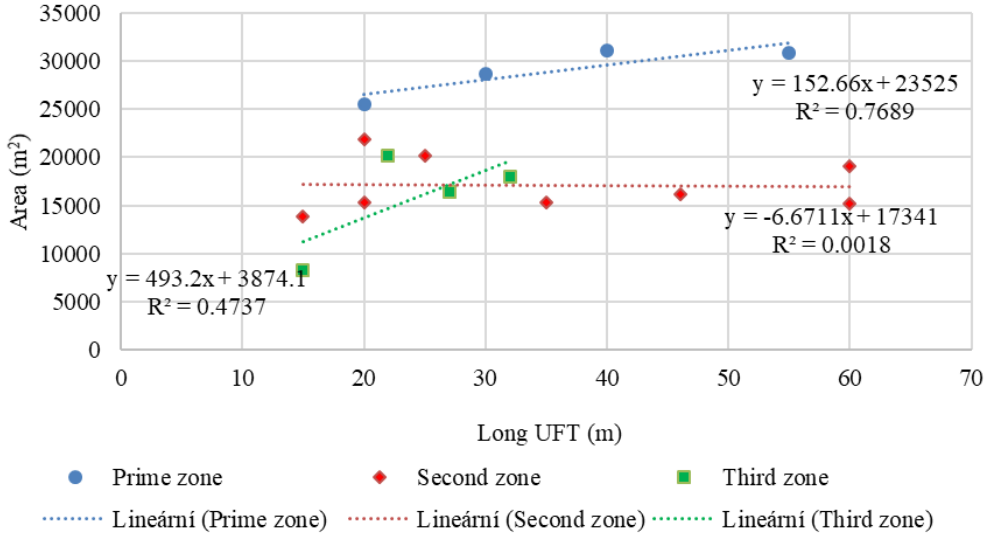

Fig. 5 – Influence of the length of the UFT with the area of influence. Source: own research

It is noteworthy that, in the confluence of primary zones, there is a high overlap of areas of influence. Likewise, it is deduced from the results that all the areas of influence of the loading and unloading parts are located between secondary zones. The tertiary ones are well supplied without requiring additional loading and unloading areas.

The results show that merchandise areas located in prime zones have a high relationship (76%) with the establishments they supply. Following this idea, the degree of relationship is significant

since the density of shops in this area is high and, as a result, dealers prefer to park in these areas. Although the secondary zone shows an anomalous behaviour since, at greater UFT length, the area of influence to which it distributes remains practically constant, this means that vehicles prefer to park in other areas where the rotation ratio parking is higher and, consequently, the delivery time is shorter. Finally, mentioning that the tertiary zone is not affected by the primary one since the levels of demand are much lower and farther from them. In contrast to what happens in the secondary zone, in the tertiary area the relationship between parking and the area of influence is 47%; this value indicates the good behaviour of these areas. It should also be noted that, when several primary areas converge, there is a large overlap of areas of influence due to urban issues, and that can be solved by modifying the lengths as well as the locations of secondary areas adjacent to them. Therefore, it follows from the results that most of the logistics areas are located between secondary areas, which need a restructuring in order to increase their performance.

## 5 CONCLUSION

Aiming at getting that loading and unloading areas work optimally in the vicinity of prime and pedestrian areas, these must be located in tertiary areas or in the confluence zones of secondary and tertiary streets. Therefore, it is concluded that, in order to establish an optimal loading and unloading area, it is necessary to take into account, not only the type of establishment that predominates in the area, but also the characterization of the street and its morphology. For this reason, it is proposed that, in the confluence of primary areas, where most traffic congestion takes part, a consolidation centre should be installed to reduce the parking ratio of logistics operators (Alho et al., 2015) or should also be considered the replacement of the secondary zones to modify the parking ratios and make the logistics zones of the prime zone work more efficiently.

The teamwork suggests diverse points to take into account for future studies: the establishment of objective criteria when obtaining the streets classification. For instance, the street attractiveness should not be sized only by noticing about the number of pedestrians, but also regarding areas of confluence in addition to the density of cultural environment which appeal to the public. Likewise, considering the area of confluence of loading and unloading zones commented above, it is recommended to optimize the methodology approached in chapter 3. All this by raising more detailed surveys and using statically techniques that allow us to find out what occurs out of rush hours and the seasonality through the year.

### References

- Alho, A., & De Abreu e Silva, J. (2015). Utilizing urban form characteristics in urban logistics analysis: a case study in Lisbon, Portugal. *Journal of Transport Geography*, 42, 57-71. doi: 10.1016/j.jtrangeo.2014.11.002
- Allen, J., Browne, M., & Cherrett, T. (2012). Investigating relationships between road freight transport, facility location, logistics management and urban form. *Journal of Transport Geography*, 24, 45-57. doi: 10.1016/j.jtrangeo.2012.06.010
- Ambientum (n.d.). *Áreas públicas y privadas*. Retrieved from [https://www.ambientum.com/enciclopedia\\_medioambiental/suelos](https://www.ambientum.com/enciclopedia_medioambiental/suelos)
- Anderson, S., Allen, J., & Browne, M. (2005). Urban logistics: How can it meet policy makers' sustainability objectives? *Journal of Transport Geography*, 13, 71-81. doi: 10.1016/j.jtrangeo.2004.11.002

- Chiquetto, S. (1997). The environmental impact from the implementation of a pedestrianization scheme. *Transportation Research Part D: Transport and Environment*, 2(2), 133-146. doi: 10.1016/S1361-9209(96)00016-8
- Dablanc, L. (2007). Goods transport in large European cities: Difficult to organize, difficult to modernize. *Transportation Research A*, 41(3), 280-285. doi: 10.1016/j.tra.2006.05.005
- Dezi, G., Dondi, G., & Sangiorgi, C. (2010). Urban freight transport in Bologna: Planning commercial vehicle loading/unloading zones. *Procedia - Social and Behavioral Sciences*, 2(3), 5990-6001. doi: 10.1016/j.sbspro.2010.04.013
- Fang, K., Wang, X., Chen, L., Zhang, Z., & Furuya, N. (2019) Research on the correlation between pedestrian density and street spatial characteristics of commercial blocks in downtown area: a case study on Shanghai Tianzifang. *Journal of Asian Architecture and Building Engineering*, 18(3), 233-246. doi: 10.1080/13467581.2019.1627215
- Gómez, R. (2000). El papel del comercio en la revitalización de los centros urbanos en Europa: las declaraciones de Málaga y Lille. *Gestión y Análisis de Políticas Públicas*, 19, 71-78. doi: 10.24965/gapp.vi19.232
- Harris, N. (1994). The emerging global city: transport. *Cities*, 11(5), 332-336. doi: 10.1016/0264-2751(94)90086-8
- Hass-Klau, C. (1993). A review of the evidence from Germany and the UK. *Transport Policy*, 1(1), 21-31. doi: 10.1016/0967-070X(93)90004-7
- Herrera, E. (2016). *Hacia una gestión inteligente de la logística de la última milla*. Retrieved from <https://www.esmartcity.es/comunicaciones/hacia-gestion-inteligente-logistica-ultima-milla>
- Herrera, N. (2012). Peatonalización y dinamismo comercial: El caso del centro histórico de la ciudad de La Laguna (Canarias-España). Proyecto de Investigación. Ciudad y calidad de vida. El uso social de los espacios públicos abiertos en las ciudades españolas, XX Coloquio de Historia Canario-Americana, 107-117. Retrieved from <https://mdc.ulpgc.es/utills/getfile/collection/coloquios/id/2227/filename/2220.pdf>
- Lindholm, M. (2013). Urban freight transport from a local authority perspective: a literature review. *European Transport/Trasporti Europei*, 54(3), 1-37. Retrieved from <https://www.openstarts.units.it/handle/10077/8869>
- Miralles-Guasch, C., & Tulla, A. (2012). Recent territorial dynamics in the Barcelona metropolitan region. *Boletín de la Asociación de Geógrafos Españoles*, 58, 299-497. Retrieved from <https://bage.age-geografia.es/ojs//index.php/bage/article/viewFile/2086/1999>
- Monokrousou, K., & Giannopoulou, M. (2016). Developing a methodological approach for interpreting and predicting pedestrian movement in a public space for sustainable urban planning. *WIT Transactions on Ecology and the Environment*, 204, 239-248. doi: 10.2495/SC160201
- Morana, J., Gonzalez-Feliu, J., & Semet, F. (2014). Urban Consolidation and Logistics Pooling. In: J. Gonzalez-Feliu, F. Semet F. & J. L. Routhier (Eds.), *Sustainable Urban Logistics: Concepts, Methods and Information Systems*. Berlin: Springer. doi: 10.1007/978-3-642-31788-0\_10
- Muñuzuri, J., Onieva, L., Cortes, P., & Guadix, J. (2016). Gestión pública de la logística urbana de mercancías. Una norma, múltiples necesidades. *Economía Industrial*, 400, 21-28. Retrieved from <https://dialnet.unirioja.es/servlet/articulo?codigo=5687069>



- Muñuzuri, J., Grosso, R., Escudero, A., & Cortés, P. (2017). Distribución de mercancías y desarrollo urbano sostenible. *Revista Transporte y Territorio*, 17, 34-58. doi: 10.34096/rtt.i17.3866
- Oliveira, L. (2014). Diagnóstico das vagas de carga e descarga para a distribuição urbana de mercadorias: um estudo de caso em Belo Horizonte. *Journal of Transport Literature*, 8(1), 178-209. doi: 10.1590/S2238-10312014000100009
- Palomares Borja, R. (2015). *Marketing en el punto de venta*. Madrid: ESIC Editorial
- Ros, L., De La Fuente, M. V., Ros, D., & Cardós, M. (2018). Analysis of freight distribution flows in an urban functional area. *Cities*, 79, 159-168. doi: 10.1016/j.cities.2018.03.005
- Russo, F., Polimeni, A., & Comi, A. (2008). Urban freight transport and logistics: retailer's choices. In E. Taniguchi & R. G. Thompson (Eds.), *Innovations in City Logistics*. Hauppauge: Nova Science Publishers. Retrieved from <https://art.torvergata.it/handle/2108/22968#.Xhm53chKjIU>
- Salom, J., Carrasco, J. M., & Puebla, A. (2014). Delimitation and characterization of new urban spaces in Valencia. *Boletín de la Asociación de Geógrafos Españoles*, 64, 127-149. Retrieved from <https://bage.age-geografia.es/ojs//index.php/bage/article/viewFile/1709/1626>
- Sastre, J., Sastre, A., Gamo, M., & Gaztelu, T. (2013). Economic Impact of Pedestrianisation in Historic Urban Centre, the Valdemoro Case – Study (Spain). *Procedia - Social and Behavioral Sciences*, 104, 737-745. doi: 10.1016/j.sbspro.2013.11.168
- Silva, R., & Rodríguez, J. (2015). Percepciones y valoraciones sociales de paisajes urbanos. Claves analíticas y potencialidades para la su incorporación a la planificación urbanística y socio-económica de ámbito local. *Biblio 3W. Revista Bibliográfica de Geografía y Ciencias Sociales*. Barcelona: Universidad de Barcelona, 15 de enero de 2015, 22 (1108). Retrieved from <http://www.ub.edu/geocrit/b3w-1108.htm>
- Schoemaker, J., Allen, J., Huscheback, M., & Monigl, J. (2006). *Quantification of Urban Freight Transport Effects I*. Best Urban Freight Solutions. Retrieved from [http://www.bestufs.net/download/BESTUFS\\_II/key\\_issuesII/BESTUF\\_Quantification\\_of\\_effects.pdf](http://www.bestufs.net/download/BESTUFS_II/key_issuesII/BESTUF_Quantification_of_effects.pdf)
- Soni, N., & Soni, N. (2016). Benefits of pedestrianization and warrants to pedestrianize an area. *Land Use Policy*, 57, 139-150. doi: 10.1016/j.landusepol.2016.05.009
- Takahashi, H., Goto, Y., Sakuma, R., & Ishii, T. (2005). The Relationship between the Movements of Visitor's Walking around and the Density of Stores on Commercial Area: A Case Study on the Area around Shimokitazawa-Station. *Journal of the City Planning Institute of Japan*, 40(3), 649-654. doi: 10.11361/journalcpj.40.3.649
- Taniguchi, E., & Thompson, R.G. (2015). *City logistics mapping the future*. Boca Raton: CRC.
- Taniguchi, E., Thompson, R. G., Yamada, T., & Van Duin, R. (2001). *City logistics: Network modelling and intelligent transport systems*. Oxford: Pergamon.
- WCED. (1987). *Report of the World Commission on Environment and Development: Our Common Future*. World Commission on Environment and Development A/42/427.
- Woudsma, C., & Jensen, J. (2005). Accessibility and Freight: Transportation and Land Use Exploring Spatial-Temporal Dimensions. In D. Levinson & K. Krizek (Eds.), *Access to Destinations*. doi: 10.1108/9780080460550-013.

- Woudsma, C., Jensen, J. F., Kanaroglou, P., & Maoh, H. (2008). Logistics land use and the city: a spatial–temporal modeling approach. *Transportation Research Part E: Logistics and Transportation Review*, 44(2), 277-297. doi: 10.1016/j.tre.2007.07.006
- Yannis, G., Golias, J., & Antoniou, C. (2006). Effects of Urban Delivery Restrictions on Traffic Movements. *Transportation Planning and Technology*, 29(4), 295-311. doi: 10.1080/03081060600905566
- Zunder, T. H., & Ibáñez, J. N. (2004). Urban freight logistics in the European Union. *European Transport/Trasporti Europei*, 28, 77-84. Retrieved from <https://www.openstarts.units.it/handle/10077/5859>

### **Contact information**

#### **Juan Carlos Gómez Sánchez**

Technical University of Cartagena, Faculty of Industrial Engineering  
C/ Dr. Fleming S/N, 30202, Cartagena, Spain  
E-mail: [j.carlosgomez@upct.es](mailto:j.carlosgomez@upct.es)  
ORCID: 0000-0002-2828-483X

#### **María Victoria de la Fuente Aragón**

Technical University of Cartagena, Faculty of Industrial Engineering  
C/ Dr. Fleming S/N, 30202, Cartagena, Spain  
E-mail: [marivi.fuente@upct.es](mailto:marivi.fuente@upct.es)  
ORCID: 0000-0002-5283-8003

#### **Lorenzo Ros Mc-Donnell**

Technical University of Cartagena, Faculty of Industrial Engineering  
C/ Dr. Fleming S/N, 30202, Cartagena, Spain  
E-mail: [lorenzo.ros@upct.es](mailto:lorenzo.ros@upct.es)  
ORCID: 0000-0002-1736-7525

doi: 10.7441/dokbat.2019.028

# POTENTIAL OF IMPLEMENTING SMART GLASSES IN A BRICK AND MORTAR SHOP ENVIRONMENT

*Tadej Gračner, Luka Herman, Brigita Gajšek*

## **Abstract**

In today's cutthroat business environment, implementation of innovative technology solutions can mean winning a competitive edge. At this, brick and mortar stores are no exception. Shoppers expect their shopping in a store to be a special experience. In addition, they also want to be effective at shopping. Stores are trying to get closer to them with their arrangements and content. The main goal of every kind of a shop is promotion of sales. It is important that shops have something to keep customers in the store as long as possible to see and spend more than they planned on the entrance. Consequently, an intensive search for new technological solutions is underway. Paper studies the implementation of smart glasses with voice support, as one of viable technological solutions, in a brick and mortar shop environment. Advantages such as reduced time for dull routine tasks and faster decision making are expected. There is also a strong possibility to facilitate the search of the wanted product through voice pick support. Based on the study of the use of smart glasses in other industries and in private life, we are looking for functionalities that could be used in stores. In addition, we analyse available scientific studies on the use of smart glasses. The research goal is to define advantages, disadvantages, opportunities and challenges of implementation of smart glasses for customers in shop environment. Conclusions will also be based on live experiment in which we used Vuzix M300 smart glasses for picking of goods from shelves. The result of the research will be given in the form of recommendation for practice and science.

*Keywords: smart city, smart glasses, time management, brick and mortar shop*

## **1 INTRODUCTION**

New technologies, developed every day for last past years, can reach their fully usefulness in next years. Since the day, when the telephone and later the Internet were developed, we can find a lot of new technologies and ideas to make almost every job easier. However, the time will come, when technology providers will need to offer their services to people for free time use. The use of new technologies will lead to emergence of smart cities. Smart city's main objective is to make citizens' lives easier in every possible way – sustainability, transportation, etc. – using data collection and measurement as one of the essential tools (Azahara, 2017).

The purpose of this study is to find out if the continued use of smart glasses has an effect on human eyesight. We are interested in this subject because smart glasses are an innovative new technology with a lot of potential to improve the consumer experience, more specifically we are interested if this new technology is ready to be used by consumers. We tested smart glasses with volunteers, testing their eyesight after long-term use using standardized tests. We compiled the results and used statistical methods to analyse them.

## 2 THEORETICAL FRAMING

### 2.1 Smart city and Shopping trends

A Smart city is an urban area that uses different types of electronic Internet of Things (IoT) sensors to collect data and then use these data to manage assets and resources efficiently. This includes data collected from citizens, devices, and assets that is processed and analysed to monitor and manage traffic and transportation systems, power plants, water supply networks, waste management, crime detection, information systems, schools, libraries, hospitals, and other community services. (Fourtane, 2018; McLaren & Agyeman, 2015; Musa, 2016)

Smart technology can be used in many potential areas around the city. For these reason government leaders need to prioritize those, which will be to the greatest benefit. Ten of them are presented on Figure 1.



Fig. 1 – Ten Big Priorities Government Leaders Should Focus On. Source: Forbes Technology Council (2018)

Rapid urban growth requires the development of smart cities. In order to make for a living, people in the countryside are massively moving to cities where they can find jobs, they love. In doing so, the proportion of the population living in cities is increasing. Those people need every day various goods and are not willing to spend hours on shopping. Trying to navigate floors and floors of haphazardly organized, uncarted stock in search of a specific product is not just frustrating, it is defeating - second only to the difficulty in trying to flag down an actual salesperson to help them out (Finkelstein, 2018).

Finkelstein (2018) posted five trends poised to transform shopping for the better in 2018: **experiential shopping, minus the gimmicks** – for example London’s House of Vans opened a custom BMX and skate park in the bottom of its flagship store. That was a dedicated effort to give customers a place to do what they love; **next level personalization** – one of the surest ways to create meaning for customers is to create a product or service expressly for them. Customization is allowed by better, bigger data, streamlined digital interfaces and on-demand manufacturing; **augmented reality (AR) that is actually useful (and artificial intelligence (AI) that is not annoying)** – AR integrations in applications (apps) from stores like Magnolia and Ikea let customer see products in his/her space before he/she buys; **mobile goes mainstream** – mobile checkouts are on the rise. Almost 65% of Black Friday/Cyber Monday sales occurred on mobile across Shopify platforms in 2017; and **social shopping finds its niche** – social media today is a lot like the place where everyone gets together to socialize and window-shop. Integrated application for purchasing on Facebook, Instagram and Pinterest has evolved dramatically in recent times, enabling social media users to pick up finally their goods without leaving the virtual neighbourhood.

Furthermore, Johnson (2019) reveals innovative retail trends to watch: **physical stores for digital native brands** – according to real estate experts, digitally native brands (started online) are predicted to open 850 brick-and-mortar stores in the next 5 years, with New York being the most popular destination; **shopping with AR** – mega-brands like Target, Lowe's, and Amazon have launched AR features that allow shoppers to picture furniture in their homes. With the AR market anticipated to reach \$133 billion by 2021, smaller retailers are undoubtedly close behind; **product customization** – ecommerce and brick-and-mortar stores alike are offering more options than ever to customize your purchase, from monograms and embroidery to fully unique colour schemes; **visual search** – visual search allows shoppers to find and buy a product just by snapping a photo. AI works its magic to identify the product (or similar ones) across multiple sites and retailers in just a click; **omnichannel experiences** – Sopadjeva, Dholakia and Benjamin (2017) reported that 73% of shoppers used multiple channels to shop; **pop-up shops** – according to Storefront (2019), temporary retail is expected to generate \$ 80 billion on an annual basis. Pop-up stores have become increasingly valued as a tool for the industry to navigate the unknown: experimenting with products, locations, tenant-mixes and commercial agreements; **same day delivery** – PwC (2019) reports that 88% of consumers are willing to pay for same-day or faster delivery. From Amazon's Prime Air, which uses drone technology to deliver shopper's orders in 30 minutes or less, to the rise of delivery robot start-ups, delivery is only getting faster; **social shopping** – shoppable Instagram posts and stories in particular have taken off in the last year, with 41% of ecommerce brands using this feature; **private label brands** – according to CB Insights, sales of private label products are growing three times faster than branded products; **ethical and values-based brands** – consumers are becoming more and more conscious of the ethos behind the businesses they buy from.

Trends reveal attractiveness of AR for use in retail. That motivates us for researching the potential for use of smart glasses. According to Eggers and Skowron (2018), focus in smart cities is attention for residents. To ensure that the mentions are focused, cities must ensure better quality of life, economic competitiveness, environmental focus on sustainability. Retail sector can largely help to reach optimistic goals of smart city incentive by solutions that influence on less energy spend on moving goods from sources to places of consumption. However, one of the most important daily commitments can be called time. Time spend doing an activity is considered a worthwhile or useless. What we want to emphasize is that time cannot be turned back and the amount of useless time, spend in one day, is the time, which people can do something useful.

## 2.2 Smart glasses

Smart glasses, the eyewear technology that layers information onto a user's field of view, started off operating as simple front-end displays but have been progressing towards being able to perform complex computer powered tasks. This steady improvement in processing performance is, consequently, making this wearable device prove its worth in the market. (Kohles, 2017)

Smart glasses can be called the technology of the future because its ease of use. It is true that the use of the first hours is quite complex, but over time, people get used to them. The mere introduction of smart glasses in the everyday or in the business environment is almost a step of the future. Inspiration for our research were smart glasses Vuzix M300, presented on Figure 2.

As mentioned earlier, imagining living in the world without technologies such as the telephone seems to be almost impossible. Using a smartphone, which is used by most of the people, is a necessity nowadays. It helps us to overcome one of the main challenges of logistics, distance between two or more people. Comparing the past with the present, the phone was not accessible to everyone. That is why, in the past, people often visited each other because of business or

non-business purpose. Thus, development of a phone and internet makes life much easier for people. Either however, as people spend more and more time on computers or on the phone, everyday use of them becomes dangerous, since the use requires one or two hands and the full attention of the user, who at the loss of attention only for a moment risks his life.



Fig. 2 – Smart glasses Vuzix M300. Source: Vuzix (2019)

### **2.3 Where can the Smart Glasses be used?**

Smart Glasses can be used nearly anywhere, but they have to be configured (programmed) properly, for the type of usage. This can be done only by those who are accordingly qualified. Since most of the work is done through a Computer, we believe that in the future it will be self-explanatory to write instructions or a program that will automatically load on the Smart Glasses. As mentioned earlier, the use of Smart Glasses shows the potential for saving people's time. Below we will describe examples of current and future usage of Smart Glasses.

### **2.4 Libraries in smart cities**

People commonly use libraries for borrowing reading material. In most cases, we go to the nearest library to see on local computers whether certain book is still on the shelf. The computer then shows us the section and the location of the book. Libraries have stacked books according to the first letter of the author's surname, which may be called as an identification letter. In most cases, we search for a desired work, where several books are written by the same author (e.g. 30 to 50 books or copyright works). When the correct identification letter is found, a search of the reading material begins. In such cases, there is a huge loss of focus and consequently a loss of time due to retrieval of the desired reading material.

Smart glasses, as a technology of the present as well as the future, will prevent most activities of unnecessary searching. As mentioned, smart glasses consist of a simple frame of purely ordinary glasses and a small Screen from which we receive the desired Information. At the end of the frame, in the immediate vicinity of the human ear there is also a loudspeaker through which voice guidance can be enabled. Similar as with a GPS device in the personal car. Because Smart Glasses will allow two-way Communication, any search activity will become simple.

With introduction of Smart Glasses in Smart Cities we would eliminate the waste of valuable time, make it easier to find what you want and as a result reduce stress. Libraries of the future would be equipped with RFID technology and Smart Glasses. To allow functionality, all Books in the Library should be tagged or labelled with RFID marking. Smart Glasses would then provide a tool to read RFID markings.

A person who would wear the Smart Glasses will have to register or login, simply tell their wishes to the system using a two-way communication. After that, the Glasses, more specifically the program in the Glasses, will check the availability of the book in the current Library and guide the user to the exact Location of the desired book. However, since the books are equipped

with RFID tags the display will show our wanted book with green highlight. The whole procedure would be finished, and the user would simply return the Smart Glasses on the vantage point and leave with a book in hand. With the preliminary login in the Smart Glasses system the user does not have to check the book, since the system automatically logged a book rental when we first picked up the desired book. The final confirmation that the book was borrowed would be done at the exit where a main RFID reader would be located.

## **2.5 Stores in Smart Cities**

The Current trend indicates that there are more and more retail and wholesale stores day by day. In all of the countries there are only a few wholesalers who hold a strong position. The stores in this case are used as a hub for related products from different manufacturers. Their main purpose of business is to make a profit. The expansion of store openings is on the rise, providing better care and supply for the local population. This allows people to reach their local store in a matter of minutes on foot or with a transportation device.

For our visits to the store, we use a product list that vary in size, depending on the distance from the store. The further away from the store, the longer the list and at the same time it affects the frequency of store visits – the longer the distance, the fewer the visits. Upon arrival at the store, we decide, depending on the length of the shopping list, whether or not we will need a shopping cart and start with our picking up products. The placement of products on shelves is carefully planned for the benefit of retailers, as the consumer often purchase what he does not need or does not have on his list. The shopping process ends with the payment of the goods.

Stores in smart cities are expected to be equipped with Smart Glasses as is the case in libraries within smart cities. There are two ways to use Smart Glasses: (1) use of Smart Glasses with RFID tags; (2) use of Smart Glasses with a mini barcode reader attached to the frame of Smart Glasses, attached to the frame of Smart Glasses. The alternative option to use Smart Glasses is a slightly cheaper and more efficient version, as it avoids the additional cost of labelling products with RFID tags. The use of Smart Glasses will be easy for the consumer, as he will load the shopping list onto a USB stick or memory card, which he will insert into the opening on the Smart Glasses in the chosen store. The Smart Glasses program will analyse the list and sort the products by distance. Such a management system is called »Pick-By-Vision« system. Smart Glasses also provide a two-way communication called the »Voice-Pick« system. After selecting the items, the user has to scan the barcode of the product, which is collected in the Smart Glasses system, so that we can track the full amount of the purchase. The last step is waiting for us at the checkout counter, where the data from the Glasses is transferred to the checkout counter, thus ending the purchase.

## **2.6 Tourism in smart cities**

Tourism in major cities of all countries is increasingly evolving. Namely, all tourist sites are accessible to large population of the world. This is possible due to relatively low prices of air tickets, bus services, etc. We should not forget to mention train travel, which use is increasing, and possibility to rent cars. At the same time, it is necessary to point out the low prices of accommodation and the wide culinary offer. The constant development of the above means more tourists.

Today, travel agencies offer a wide range of guided tours. Our vision of smart cities is that tourists would have more free time to visit the sights and better knowledge about sights history. To achieve that, we would use smart glasses through which users will be able to obtain all the necessary information for successfully viewing the desired sights, the best restaurants, etc.



Smart cities could develop an online platform for tourists to be able to plan early and upload presentations in different languages on smart glasses. They have the ability to connect to the Internet, because of which it would be much easier to travel from landmarks to landmarks. The built-in speaker, however, would also allow two-way communication. This means that users of smart eyeglasses could also get an answer if asked.

### 3 ABOUT RECENT CASE STUDY

With the spread of the use of smart glasses, even in industrial environments, many questions arise. Three faculties, namely the Faculty of Logistics, the Faculty of Mechanical Engineering and the Faculty of Medicine, addressed some of them. All three faculties are members of the University of Maribor. Project "Study of the effects of the use of smart glasses on vision and productivity in the case of commissioning" was supported in the public tender project work with economy and non-economy in local and regional environment - the creative path to knowledge 2017-2020. The program is co-funded by the Ministry of Education, Science and Sport and the European Union through the European Social Fund. The key to success was the collaboration with Špica International d.o.o., which lent the Vuzix M300 smart glasses for testing purpose. The glasses are designed for industrial purposes and are suitable for use in a wide range of industrial environments, in the fields of manufacturing, storage, technical support, as well as healthcare and logistics, with a wealth of accessories and applications. Smart glasses were used for order picking process, which we performed on a storage rack donated by Slovene retailer Mercator. Another important partner was the Health Center Dr. Adolf Drolc from Maribor, who made it possible to perform vision measurements and interpret the results.

#### 3.1 Methodology

The test environment was a storage rack with shelves at four different heights from the ground. Locations and items have been tagged with QR codes (Figure 3), although even appropriately sized barcodes would not pose an identification problem.



Fig. 3 – Testing environment. Source: own research

The person who tested the smart glasses for four hours without interruption received instructions on items, number of pieces and pick and place locations in a form of alphanumerical symbols on display on the smart glasses in front of the right eye below. Fourteen persons, mostly students, tested smart glasses. The testing period lasted four hours. Before and after use of smart glasses several ophthalmologic tests (visual acuity, contrast sensitivity, visual field testing and colour test) were performed (Figure 4), therefore we got 28 measurements altogether (Vujica Herzog et al., 2018).



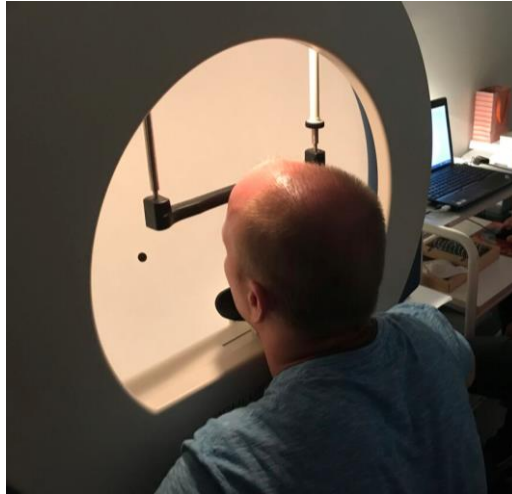

Fig. 4 – Performing one of the tests with Octopus perimeter. Source: own research

### 3.2 Results

Sixty-four percent of users rated tested smart glasses as physically distressing. The model they wear did not fit comfortably with their heads. Some of the users reported that smart glasses sometimes slide out of the head when folded, clamped upwards or in the case of jerky movements. Smart glasses started to be heavier for wearing from hour to hour. Some users experienced head or ear pain during four-hour use. Long cables were occasionally caught on some protruding parts. That kind of situations hampered the work. In some professional environments that be a reason for work accidents. The cable was attaches to the glasses on unique way; disassembly was not easy and logical. That caused the damage on smart glasses and suspension of work, which would be unacceptable in the business environment.

Sixty-four percent of users did not have any particular problems with the left eye while they were using the smart glasses, and 43% of them confirmed this with the right eye. The users mentioned the occasional short-term inability to change quickly from a view on a real work environment to a view on a smart glasses' display. The image on the display was blurred or they had difficulties to sharpen the image in a short time. Some of them experienced mild pain in the right eye, a slight headache, double vision, blurred vision.

78.6% of users failed to perform in parallel body movement and reading the information on the display of the tested smart glasses. While retrieving information from the smart glasses' display, most of the users had to stop. Individuals who managed to conquer the simultaneity of movement and information reading were more productive. For larger productivity is important that the user has a positive attitude to new technologies.

From the experiment, we cannot claim that the multi-hour use of the tested smart glasses negatively affects the user's eyesight. The visual acuity of the right eye after working with smart glasses decreased on average by 7.6% in comparison to the average result before work. This means that users saw slightly worse on right eye after work than before work. A comparable but slightly better result (6.7% reduction) was observed for the left eye. Measured visual acuity did not fall below the lower limit, which still permits obtaining a driving license. Even in worse case, our test users would have obtained a driving license. The field of view or area that a person sees with one eye was also checked when his gaze was fixed at one point. The test looked for scotoma or defects in the visual field of the test subjects. Before working with smart glasses, scotoma did not appear at any person. After working with smart glasses, scotoma appeared at six people out of fourteen who used smart glasses (43%). Scotomas in the field of view of the healthy eye do not occur throughout the day. In our case, the observed scotoma did not occur

within 20 degrees of the central binocular field of view that means that the condition after work with smart glasses will not likely affect the ability to drive a passenger car.

The use of smart glasses for identifying codes on tags is a good decision if tags are aligned with person's eyes. The alignment of the tag's location with the height of the straightened person's eyes is the ideal situation for using smart glasses to identify codes on tags or to "scan codes" in terms of productivity and well-being. Tags placed above eye level require looking up or lifting body on fingers. Using smart glasses for several hours can have a negative effect on the vertebrae and neck muscles. However, placing tags on lower locations has a long-term negative impact on the lower spine.

A software that supports work with smart glasses is essential for productivity. The time that elapses between sending the information and starting triggered activity depends largely on the combination of technology and software solution. Reading text takes more time than communicating with symbols or by adding virtual directional characters in the form of arrows or coloured boxes to the real work environment, so called augmented reality. It is important to choose the most efficient mode of proving that the activity is finished. Smart glasses enable validation of completed task by pushing buttons on the smart glasses' frame. That action is time-consuming and ergonomically inappropriate because of need to lift arm higher from a heart. Additionally, we should not forget that the order-picker spends about 50% of the time for movements between locations and a further 20% for searching items. The software solution must include route planning and pointing on target location with help of augmented reality.

## 4 CONCLUSIONS

This paper is presenting one of the newest technologies, called smart glasses. We believe that nowadays is important to implement new technologies into companies, because only on base of implementation there is less possible to become outdated. What we are trying to explain is that when the rival companies will rise their level of business, they will increase their profitability by obtaining more customers. Consequently, there is strong possibility to decrease their costs.

When we are talking about smart cities, we are talking about improving people's life. It is known that every day governments are dealing with main question, which answers can present various other sub questions about the nowadays main topic Air pollution. World's number one air pollution cause is eternal combustion engine, which one is getting environmentally friendly rival electric powered car. By changing our ride with other means of transportation just inside of the cities, we can say that we are already talking about smart city.

Another key to ensure people better life is reducing useless time spent on searching everyday things. As an example, we were writing about smart shops. Today most people are spending too much their time in shops. Amount the time, spent in shops, can be indicator of increasing level of stress. Shopping in big cities can be stressful, but this information depends on individual.

In the study, we found that most volunteers had trouble using the glasses, which we attribute to the fact that they used them for the first time and that the technology is still new and could use some fine-tuning. The tests, however, showed that smart glasses are safe to use for several hours without severely affecting visual acuity in a negative way.

It would be interesting to do a longer study, which would allow volunteers to get used to smart glasses and show the effects of their daily use during the course of a longer period. Similarly, comparing different models of smart glasses would be interesting and could provide more information on how to improve them and make them more consumer friendly.

By implementation of the smart glasses in bigger shops, libraries, and production and warehouse companies or even in our life, everyday activities can become much easier. Since development of rival technologies is big and it is getting even bigger, we have to think before we act. Wrong decision can lead to money loss. We suggest that new technologies have to be tested in the way, that results answer open questions.

## References

- Azahara. (2017). *Smart Cities vs. Smart Communities*. Retrieved from <https://geographica.com/en/blog/smart-community/>
- Eggers, W. D., & Skowron, J. (2018). *Forces of change: Smart cities*. Retrieved from <https://www2.deloitte.com/us/en/insights/focus/smart-city/overview.html>
- Finkelstein, H. (2018). *5 Trends That Will Change The Way Your Customers Shop in 2018*. Retrieved from <https://www.forbes.com/sites/harleyfinkelstein/2018/01/10/5-trends-that-will-change-the-way-your-customers-shop-in-2018/>
- Forbes Technology Council. (2018). *Building A Smart City? 10 Big Priorities Government Leaders Should Focus On*. Retrieved from <https://www.forbes.com/sites/forbestechcouncil/2018/08/01/building-a-smart-city-10-big-priorities-government-leaders-should-focus-on/>
- Fourtane, S. (2018). *Connected Vehicles in Smart Cities: The Future of Transportation*. Retrieved from <https://interestingengineering.com/connected-vehicles-in-smart-cities-the-future-of-transportation>
- Johnson, T. (2019). *15 Innovative Retail Trends to Watch in 2020*. Retrieved from <https://tinuiti.com/blog/ecommerce/retail-trends/>
- Kohles, C. (2017). *Smart Glasses: use cases, challenges and future potential*. Retrieved from <https://www.wikutide.com/blog-smart-glasses-challenges-future>.
- McLaren, D., & Agyeman, J. (2015). *Sharing Cities: A Case for Truly Smart and Sustainable Cities*. Cambridge: MIT Press.
- Musa, S. (2016). Smart Cities – A Roadmap for Development. *Journal of Telecommunications System & Management*, 5(3), article 144. doi: 10.4172/2167-0919.1000144
- PwC (2019). *Global Consumer Insights Survey 2019*. Retrieved from <https://www.pwc.com/gx/en/industries/consumer-markets/consumer-insights-survey.html>
- Sopadjieva, E., Dholakia, U. M., & Benjamin, B. (2017). *A Study of 46,000 Shoppers Shows That Omnichannel Retailing Works*. Retrieved from <https://hbr.org/2017/01/a-study-of-46000-shoppers-shows-that-omnichannel-retailing-works>
- Storefront. (2019). *Retail Trends & the Rise of Pop-Up Stores in 2019*. Retrieved on from <https://www.thestorefront.com/mag/retail-trends-market-report-2019-downloaded/>
- Vujica Herzog, N., Buchmeister, B., Beharic, A. & Gajsek, B. (2018). Visual and optometric issues with smart glasses in Industry 4.0 working environment. *Advances in Production Engineering & Management*, 13(4), 417-429. doi: 10.14743/apem2018.4.300
- Vuzix. (2019). *M300 Smart Glasses*. Retrieved from <https://www.vuzix.com/Products/m300-smart-glasses>

## **Contact information**

### **Tadej Gračner**

University of Maribor, Faculty of Logistics  
Mariborska cesta 7, 3000 Celje, Slovenia  
E-mail: tadej.gracner@student.um.si  
ORCID: 0000-0001-9997-2042

### **Luka Herman**

University of Maribor, Faculty of Logistics  
Mariborska cesta 7, 3000 Celje, Slovenia  
E-mail: luka.herman@student.um.si  
ORCID: 0000-0002-3947-8031

### **Brigita Gajšek**

University of Maribor, Faculty of Logistics  
Mariborska cesta 7, 3000 Celje, Slovenia  
E-mail: brigita.gajsek@um.si  
ORCID: 0000-0001-5744-7151

doi: 10.7441/dokbat.2019.029

# SUPPORT OF INNOVATIONS IN MAIN DEVELOPMENT STRATEGIES OF REGIONAL CAPITALS IN THE CZECH REPUBLIC

*Martin Habuda, Ladislav Kudláček, Aleš Gregar*

## **Abstract**

Innovation and their support by the public sector are currently in focus of intensive research in the area of regional development. Innovation capacity is considered as the main source of competitiveness of regions. The role of regional governments is emphasized in concepts such as Regional Innovation Systems and Triple Helix. Municipalities represent a lower level of government. In some cases, depending on the country's public administration system and the size of the municipality, these entities may be very strong participants for regional governments. Such municipalities naturally have the potential to act as important participants in regional innovation systems, and they should clarify these roles in their strategic documents. The paper focuses on the topic of innovations support within the main development strategies of regional capitals in the Czech Republic. It provides findings on how the topic of innovations support is included in the structures of these strategies, identifies typical aims, measures, activities and instruments for supporting innovation, assesses the complexity of innovations support declared in these strategies and draws a conclusion on the importance of this topic in terms of regional capitals. Research is based on the scientific method of text document analysis. The main development strategies of twelve regional capitals in the Czech Republic were analysed by this method. The documents were gathered for the research at the turn of September and October 2019. The results of the research show that innovations support represents an important topic in the main development strategies of the regional capitals in the Czech Republic. At the same time, methodological inconsistencies in the elaboration of the examined strategies were identified, especially in terms of structure, terminology, and degree of detail.

***Keywords:** strategic planning, innovations support, regional development, local development, competitiveness, regional innovation system*

## **1 INTRODUCTION**

The paper interconnects the topic of strategic planning of regional development at the municipal level with the topic of innovation support. Concerning this, the introduction part is divided into three sub-parts. The first part provides an overview of the strategic planning of regional development in the Czech Republic on the level of municipalities. The second part deals with theoretical bases in the field of innovation support. The third part summarizes current situation in the field of support of innovation in the framework of strategic planning in the Czech Republic at the regional and municipal level.

### **1.1 Strategic planning of regional development in the Czech Republic at municipality level**

According to the one of the most respected definitions by Bryson (2011), the strategic planning is "deliberative, disciplined approach to producing fundamental decisions and actions that shape and guide what an organization (or other entity) is, what it does, and why." The purpose is to help managers and leaders overcome with the biggest challenges and problems an organization face; this ability of strategic planning stems from its complexity which comprises of a wide and detailed analytic view of the organization and its internal and external environment, identifying

key issues and challenges, finding possible ways how to resolve the issues and the challenges and choosing the best from them; and it all is done in the deliberative way with the participation of key stakeholders (Bryson, 2011). Vozáb (1999) points out that strategic planning is considered as a very universal method, both from the types of planning entities and from the territory or the thematic focus, which the plans deal with.

With the growth of the complexity of relations within society, the importance of municipalities' strategic planning also grows. "Strategic planning represents the only management tool, that allows embracing the issue of evolution, resp. development of a given area, complexly and effectively guide it within the sustainable development principles" (Habuda, 2013). Bryson (2011) shows dramatically growing amount of dynamic changes in the society when the survival of an organization, including an organisation in the public sector, is not easy in such conditions; he accentuates that organisations of the public sector will have to think, act and learn strategically more than ever before.

The situation of strategic planning at municipality level in the Czech Republic has been the subject of several researches in the past. For example, according to an extensive questionnaire survey conducted in 2015, 82.4% of municipalities have or are preparing their development strategic plans (Ježek et al., 2015). Similarly, Grebeníček et al. (2013) identified that of the 13 Czech regional capitals, 12 have approved a strategic development plan. At the same time, there is a very rich offer of methodologies and procedures on the topic of preparing strategic plans for towns and municipalities (Ježek, 2014).

However, there are many problems in this area. For example, strategic planning motivated primarily by efforts to obtain subsidies from EU funds brings about another complication in the form of the frequent occurrence of non-systemic strategies (Ježek et al., 2015). Regarding the quality of municipal planning documents and the possibilities of their mutual comparison, the authors point to considerable terminological and methodological inconsistencies of strategic municipal documents, their comparison is then more complex (Grebeníček & Hájek, 2013; Grebeníček et al., 2013). Ježek et al. (2015) summarizes that the centre of the strategic documents of the municipalities is in an analysis rather than in setting a long-term conception; nevertheless the analysis is presented by broad sums of quantitative data but there are no deeper analytical results concluded from it, there are no consequences and connections explored, creative methods are used much less; though widely accepted, the analyses show superficial character. They reveal an overly wide and general span in the proposal parts of the strategic documents, apparently motivated by the effort to cover all of the areas where available funding sources can be expected; prioritizing the proposals and plans usually lacking. They conclude that the plans are broadly covered lists rather than definite strategies, in which this type of conception is in contradiction with the basic conditions of the strategic planning. Despite their findings regarding insufficient prioritization, Řehoř (2015), who observed strategies of small settlements and microregions in the region of South Bohemia, identified a relatively high share of strategies that have systematically set their prioritization of proposals and plans.

There are also considerable problems in the process area. The rate of the participation of subjects in strategic planning is stated as relatively high in the researches (Řehoř, 2015; Ježek et al., 2015). However, its ability to coordinate various interests and the needs of the subjects falls considerably behind the theoretical preconditions (Slach & Ježek, 2015). The implementation level of the strategies has a very weak position, the settings of the implementation processes is totally missing or is very superficial and executed ineffectively in most of the strategic documents, there is no set of indicators and regulations for evaluating of the documents, action plans are not prepared (Ježek et al., 2015; Řehoř, 2015). The efficiency

of the implementation processes is also lowered by a weak interconnection of planning and budgeting by the municipalities (Grebeníček & Hájek, 2013; Grebeníček et al., 2013).

This clearly shows that the planning culture in the Czech Republic is not in good condition. Ježek (2014) summarizes that local planning reality does not stem from the theoretical level, the basic political expectations are not fulfilled, and it is a "planning for planning". Novák (2010) even talks about frequent managerial failures in this context. Researchers generally share a negative assessment of the situation, but in some aspects there are indications of positive development.

## **1.2 Innovations and instruments to support them**

Innovations and their support by the public sector are currently the focus of intensive research in the area of regional development. Innovation capacity is considered as the main source of competitiveness among the regions.

The prerequisite for creating innovations is appropriate knowledge, as part of an experience or as resulting from a research process, as well as the ability to learn. Knowledge according to Truneček (2004) represents "purposeful coordination of action" and "Ability (art) to do something". However, creating knowledge and the learning process are not an isolated matter within a particular organization, but on the contrary show strong spatial contexts, represented mainly by a network of relationships in its vicinity, as Malmberg (1997) states, for example, when they gain considerable attention in national and regional competitiveness research. Many authors speak about the diffusion of innovation in this context. Differences in the ability to learn and innovate are seen as an essential mechanism for differentiating of the economic development of regions (Maskell, 1998). For example, several studies and researches have shown a strong spatial concentration in high-tech industries.

Various institutional frameworks and concepts have been developed to support the creation and diffusion of knowledge and innovations. Clusters and regional innovation systems have become the most popular ones, which are now an integral part of the political agenda in the European Union.

The concept of regional innovation systems was introduced in the early 1990s by geographer Philip Cooke (Cooke, 1992). Subsequently, this concept has been developed by several other authors and continues to receive considerable attention from the scientific community. The concept of regional innovation systems is both an analytical framework for the research of the competitiveness and innovation performance of individual regions, as well as an instrument for the systematic support of learning in a given region. The main idea of regional innovation systems is that targeted support for the competitiveness of companies is an essential complement to existing spontaneous and accidental synergies resulting from agglomeration benefits.

Tödtling and Trippel (2005) stress the need to tailor this targeted support to the region, taking into account its specificities. An important element here is the regional policy and strategy. These authors perceive regional innovation systems as a broader concept than clusters that primarily serve to exploit and apply knowledge in one field, while regional innovation systems are a more institutionalized concept that may include multiple clusters from different disciplines in one region.

Maťátková and Stejskal (2011) provide a detailed look at the composition of regional innovation systems and their layers. They distinguish layer of enterprises, layer of complementary and supportive enterprises, and the environment and infrastructure layer.

Into the enterprises layer belong companies showing signs of innovative business. The layer of complementary and supportive enterprises include those providing additional and supportive services to the enterprises in the first layer. The layer of environment and infrastructure is then further divided into sub-parts: (a) Environment-shaping institutions (institutions forming the legal framework for entrepreneurship, strategic documents supporting innovative entrepreneurship, network facilitators); (b) Sets of initiatives (public and private initiatives supporting innovative entrepreneurship); (c) Hard and soft infrastructure (industrial zones, technology parks, science and research parks, innovation centres, technology infrastructure - research and testing centres and specialized laboratories, knowledge infrastructure - universities, and other institutions enabling knowledge transfer).

This arrangement includes private enterprises, research and education institutions and public institutions (local and regional governments). The combination of these three components is known under the term Triple Helix, introduced by Leydesdof and Etzkowitz (1998).

There is considerable agreement the governments and the public sector have the ability to influence the business environment in general, as well as the need for the public sector to play an active role in promoting entrepreneurship and innovation. The role of the public sector in this regard can be significant, both within the above concepts and in many others (Leigh & Blakely, 2013; Blažek & Uhlíř, 2011).

### **1.3 Support of innovations in the framework of strategic planning in the Czech Republic at the regional and municipality level**

Support of business and innovations by the public sector is a global topic. Governments, regions and many municipalities apply several concepts in this respect. Therefore, of course, this topic is also reflected in strategic planning at individual levels of public administration. For example, Skokan (2004) lists among the main areas the focus of regional development strategies selected instruments for business support, business development, human resource development and employment programs; it emphasizes concepts such as achieving regional competitiveness, networking, key competencies, social capital development or strategic leadership.

Grebeníček (2016) addressed the topic of supporting of business and innovations in the framework of regional development strategic planning at regional level in the Czech Republic. Important findings of his work included: (a) The topic of supporting business and innovations is one of the main common development topics of regional development strategic planning. (b) There is considerable heterogeneity among the regions in the models used for strategic planning of regional development, with a focus on promoting business and innovations.

One of the other findings from Grebeníček (2016) in his work mentions the existence of two basic models of strategic planning of regions, namely the two-stage model and three-stage model. In the two-stage model, regions prepare one basic strategic document, which is then followed by individual sector strategies. In the three-step model, the basic long-term strategy is followed by a medium-term development program followed by individual sectoral strategies. The topic of business and innovation support is addressed at all levels in both models. In the case of regional sectoral strategies aimed at promoting entrepreneurship and innovation, documents usually bear the name Regional Innovation Strategy.

The topic of Supporting business and innovations in strategic planning of regional development at municipality level in the Czech Republic was addressed by Grebeníček et al. (2013). Their research was focused on a specific group of regional capitals in the Czech Republic. They analysed the main development strategies of these cities. The main finding was that the topic of business and innovation support is addressed in all analysed strategies, using several typical instruments and activities in this respect. The author's team concluded that supporting business



and innovations is considered as an important topic by the city authorities. On the other hand, they identified insufficient financial coverage of the declared instruments and activities for the cities concerned.

However, the more narrowly conceived topic of support for innovations at the municipality level in the specific environment of public administration in the Czech Republic has not yet been sufficiently covered by previous research.

## **2 METHODOLOGY**

In the introductory phase of the research represented in this paper, the authors focused on the approaches of regional capitals of the Czech Republic to the topic of supporting innovations, declared in the main development strategic documents of these regional capitals. The inclusion of the topic of supporting innovations in the main municipal development strategy indicates an importance of this topic to the municipality and creates preconditions for real systematic action. A specific group of municipalities - regional capitals - was chosen for the initial survey. In terms of conditions of the Czech Republic, regional capitals are large cities. They are members of a group of the largest cities in the country. Their institutional capacity to address the issue of supporting innovations should be better than the institutional capacity of smaller cities and towns in the country. All regional governments in the Czech Republic deal with the topic of supporting innovations with varying degrees of success, both at the level of formalized cooperation with the Ministry of Industry and Trade of the Czech Republic within the National Research and Innovation Strategy for Smart Specialization and at the level of their activities. Regional governments naturally concentrate their activities in the field of supporting innovations within the territories of their regional capital. The spatial proximity of the regional government and the municipality on the one hand and the concentration of the regional government's activities in the territory of its regional capital on the other hand bring these entities into intensive mutual interactions within the topic of supporting innovations. Regional capitals in the Czech Republic have good preconditions to address the topic of supporting innovations from the positions of municipality and for this reason, it is appropriate to focus the initial survey on them.

The research is structured into four research questions:

Q1: Does the regional capitals have valid and approved major development strategies?

Q2: How is the topic of supporting innovations included in the structures of the examined strategies?

Q3: What typical measures, activities and specific instruments made for supporting innovations are set in the main development strategies of regional capitals?

Q4: With what degree of complexity is the topic of innovations support elaborated in the main development strategies of the regional capitals?

Q5: Does supporting innovations represent an important topic which is accentuated by the regional capitals in their main development strategies?

The research is based on the scientific method of document analysis. The main development strategies of regional capitals in the Czech Republic were analyzed by this method. Only valid, approved and published strategies were analyzed. The documents for the research were gathered at the turn of September to October 2019.

Research is based on the scientific method of document analysis. The main development strategies of regional capitals in the Czech Republic were analyzed by this method. Only valid,

approved and published strategies were analyzed. The documents were gathered for the research at the turn of September and October 2019.

The answers to the research questions were assessed as follows:

Q1: In the first step, it was verified whether the individual Czech regional capitals have valid and approved major development strategy. It was done on the basis of information from a) the online tool “Database of Strategies - Portal of Strategic Documents in the Czech Republic” operated by the Ministry for Regional Development of the Czech Republic and also from, b) content of the regional capital’s websites. Subsequently, the proportion of Czech regional capitals meeting this condition was calculated.

Q2: The topic of supporting innovations was assessed within the hierarchical structures of each strategy - whether it appears at the level of vision, set of objectives, a system of measures or as groups of activities. Subsequently, the numbers of occurrence of the topic in the individual assessed levels of strategies were presented.

Q3: Within the group of assessed strategies the objectives, measures, instruments and activities made according to the theoretical background for supporting innovations were identified. Subsequently, they were grouped by species. Based on the frequency of its occurrence across the assessed strategies, the most relevant groups were identified.

Q4: To assess the level of complexity of the topic of supporting innovations in the strategies, a three-tier scale was created: 0 - the topic is not addressed in the strategy; 1 - the topic is included in the strategy, but it is elaborated partially (in a too general form or with using only individual isolated instruments); 2 - the topic is elaborated in the strategy in a specific and systematic form using a set of several instruments and activities. The identification of sub-elements of the topic implemented within the evaluated strategies was made with using of the knowledge of theoretical background. Thereafter, the frequency of occurrence of individual grades of the rating scale was compared.

Q5: The conclusion on the importance of the topic of supporting innovations in the main strategic documents of regional capitals is induced on the basis of answers to the previous questions.

### **3 RESULTS**

The research results presented in this chapter are divided into subchapters related to the individual research questions.

#### **3.1 Group of analysed strategic documents**

The Czech Republic is divided into fourteen regions. This group of regions contains two special cases: a) the City of Prague, which at the same time comprises the functions of municipality and regional government; b) the Central Bohemia Region, which does not have a regional capital - its regional government is based in the city of Prague, meaning outside the territory of the region. For a methodologically consistent approach, these two special cases were removed from the research. The main strategic documents of twelve regional capitals were examined.

The authors apprise as a positive the finding that all regional capitals have already approved main development strategies. In the conclusions of the research conducted by Grebeníček et al. (2013), the absence of the main development strategy was identified in the case of the regional capital Jihlava.

The terminology of the type designation of the strategic documents examined is inconsistent. In the twelve examined cases five different variants occur: (a) strategic development plan (5

occurrences), (b) development strategy (3 occurrences), (c) strategic plan (2 occurrences), (d) Sustainable Development Strategic Plan (1 occurrence), and (e) strategy (1 occurrence).

The average age of the examined documents after being approved is 5.2 years. However, after taking into account the partial updates of some documents, then it is 3.3 years. These documents can therefore be considered as relevant for evaluating of strategic approaches of the given group of municipalities. An overview of the examined documents is provided in Table 1 below.

Tab. 1 – Overview of the examined documents. Source: own research

Regional capital	Document's title*	Term of approval/update	End of validity	Validity in years
Brno	Strategy for Brno	2007 / 2016	no data	no data
České Budějovice	Strategic Plan of the City of České Budějovice 2017 - 2027	2018	2027	10
Hradec Králové	Strategic Development Plan of the City of Hradec Králové 2030	2013	2030	17
Jihlava	Strategic Development Plan of the Statutory City of Jihlava 2014-2020	2014 / 2018	2020	7
Karlovy Vary	Strategic Plan of Sustainable Development of the City of Karlovy Vary 2014-2020	2014	2020	7
Liberec	Development Strategy of the Statutory City of Liberec 2007–2020	2007 / 2013	2020	13
Olomouc	Strategic Development Plan of the City of Olomouc 2017-2023	2017	2023	6
Ostrava	Strategic Development Plan of the Statutory City of Ostrava 2017-2023	2017	2023	7
Pardubice	Strategic Development Plan of the City of Pardubice 2014-2025	2014 / 2017	2025	12
Plzeň	Strategic Plan of the City of Pilsen	2018	2035	18
Ústí nad Labem	Development Strategy of the City of Ústí nad Labem 2015-2020	2015	2020	6
Zlín	Development Strategy of the Statutory City of Zlín 2020	2012	2020	9

\* Document titles have been translated from Czech to English.

### 3.2 Placing the topic of supporting innovations into the structures of examined strategies

At the highest hierarchical level of the examined strategies, thus at the level of visions, the direct occurrences of the terms connected with the topics of innovation, research and development were identified in seven cases (Brno, České Budějovice, Liberec, Olomouc, Ostrava, Plzeň, Zlín). In the another five cases, an indirect occurrence was identified, represented by terms that assume the existence of a functional innovative ecosystem in the city or region. These are terms such as dynamic development, prosperous economy, advanced economy.

In eleven out of the twelve cases, an occurrence of a separate area or priority aimed at promoting of entrepreneurship, situated in the upper parts of the hierarchical structures of the strategies was identified. The absence was identified only in the case of the Strategic Development Plan of the Statutory City of Ostrava, which is due to a strong integration of topics included in the strategy. This strategy contains only three priority areas situated in the upper part of its hierarchical structure and the topic of promoting entrepreneurship and innovations is situated at one of the lower levels. Specific sub-objectives, measures, activities or instruments related specifically to research, development and innovations occur in all of the examined strategies except the Strategic Development Plan of the Statutory City of Jihlava. In this context, it is necessary to add that the City of Jihlava only adopted its first main development strategy in 2014. This city has the shortest experience with strategic planning at the level of the city's main development strategy. The following table 2 gives an overview of all the main priorities or areas in the examined strategies in which the topic of innovations support is included.

Tab. 2 – The main development priorities. Source: own research

Regional capital	Titles of the main development priorities in the strategic documents in which the topic of innovations support is included*
Brno	Local economic development Research, development, innovations and education Image of the city and internal/external relations
České Budějovice	Business environment, human resources, education, research and innovations
Hradec Králové	Business, science, research, innovation
Jihlava	Education, business and employment
Karlovy Vary	Strengthening the local economy
Liberec	Competitive economy and entrepreneurship
Olomouc	Competitive and creative Olomouc
Ostrava	Wealth in People (integrates multiple topics including Improve Business Development Environment)
Pardubice	Economy and life in the city
Plzeň	Develop a promising labor market and link the education system with practice To raise awareness of Pilsen beyond the city borders and among the citizens of the city
Ústí nad Labem	Economic development of the city, development and management of the city, external relations
Zlín	Economic development and labor market Management and administration of the city

\* Titles have been translated from Czech to English.

### 3.3 Identified objectives, measures, activities and instruments to support innovations

The individual strategies from the examined group were prepared in a methodologically inconsistent manner, especially in terms of structure, terminology and degree of detail. This fact reduces the possibility of mutual comparisons of these strategies. Thus, in examining the inclusion of innovation support in these strategies, it has been abstracted from comparisons at the individual levels in the vertical structure. Typical objectives, measures, activities and instruments were sought across all levels in the vertical structures of the individual strategies. An overview of the identified thirteen groups of typical objectives, measures, activities and instruments is shown in Table 3. Based on the frequency of occurrence, two groups that are most important for regional capitals were identified: (a) co-ordinated cooperation between participants in the innovation ecosystem, communication platforms and networking activities, (b) ensuring human resources for research, development and innovations.

Tab. 3 – Typical objectives, measures, activities and instruments to support innovations. Source: own research

Groups of typical objectives, measures, activities and instruments	Regional capitals
Areas and spaces for innovative entrepreneurship	Brno, České Budějovice, Ostrava, Plzeň
Establishment and development of supportive innovations infrastructure - science and technology parks, technology centres, technology transfer centres, incubators, co-working centres	Brno, Hradec Králové, Liberec, Olomouc, Ostrava, Zlín
Development of clusters and technology platforms for cooperation	Liberec, Olomouc, Ostrava, Plzeň
Establishment and development of research centres	Ostrava
Support for start-ups	Olomouc, Ostrava, Plzeň, Zlín
Innovative voucher programs	Karlovy Vary
Comprehensive system of support for investors' attractions	České Budějovice, Ústí nad Labem
Ensuring human resources for research, development and innovation	Brno, České Budějovice, Liberec, Olomouc, Ostrava, Pardubice, Ústí nad Labem, Zlín
Co-ordinated cooperation between participants in the innovation ecosystem, communication platforms and networking activities	Brno, České Budějovice, Karlovy Vary, Liberec, Olomouc, Ostrava, Pardubice, Plzeň, Ústí nad Labem, Zlín
The municipality's friendliness towards universities and research organizations	Brno, Liberec, Zlín
Active participation of the municipality in the processes of preparation and implementation of the regional innovation strategy	Liberec, Zlín
Internationalization of the local innovative ecosystem	Brno, Liberec, Olomouc, Plzeň, Ústí nad Labem
Promoting of the innovativeness of the city	Brno, Liberec, Olomouc, Plzeň, Zlín

### 3.4 The level of complexity of innovations support within the regional capitals strategies

Another assessed aspect of the main development strategies of the regional capitals in the Czech Republic was the complexity of innovations support. In a slight majority (7 cases) it was found that the topic is formulated in a systematic and specific form. A minority of strategies (5 cases) deal with the topic in partial form (using limited extent of instruments or in too many general declarations). In only one case, the strategy does not include the topic of innovations support at all. Overall, the group of examined strategies evinces a high degree of variability regarding the complexity of innovations support. The classification of the individual regional capital strategies into the levels of the grading scale is shown in Table 4.

Tab. 4 – The levels of complexity of innovations support in individual strategies. Source: own research

Level of complexity	Regional capitals
Level 2 – Specific and systematic elaboration	Brno, České Budějovice, Liberec, Olomouc, Ostrava, Plzeň, Zlín
Level 1 – Partial elaboration	Hradec Králové, Karlovy Vary, Pardubice, Ústí nad Labem
Level 0 – The topic is not addressed	Jihlava

### 3.5 Assessing the importance of including of the topic of innovations support within the regional capitals strategies

Except in one case, the topic of innovations support appears in the assessed group of main regional capitals development strategies. Directly or indirectly, it is accentuated at the highest level of the hierarchical structure of these individual strategies - at the level vision. At lower levels, in the systems of objectives, measures, activities and instruments, the topic is included with varying degrees of specificity and complexity. In a slight majority of cases, a detailed systematic approach was identified. Based on these findings, the authors conclude that the inclusion of innovations support in the main development strategies of regional capitals in the Czech Republic represents an important topic for these municipalities, which they seek to understand, grasp and guide.

## 4 DISCUSSION AND CONCLUSIONS

The research helped clarify the topic of innovations support in the framework of the main development strategies of the regional capitals in the Czech Republic. Regional capitals are important participants in the regional innovation systems. They should clarify their roles and attitudes related to the topic of innovations support within their main development strategies following the general principles of strategic planning.

The main development strategies of twelve Czech regional capitals were analyzed. The individual strategies were prepared in a methodologically inconsistent manner, especially in terms of structure, terminology and degree of detail. This fact reduces the possibility of detailed mutual comparisons of these strategies.

Five research questions have been defined in the research and all were fully answered. Their evaluation is briefly presented in the following paragraphs.

Q1: Does the regional capitals have valid and approved major development strategies?

It was found that all Czech regional capitals have already approved main development strategies and all of these strategies are still valid.

Q2: How is the topic of supporting innovations included in the structures of the examined strategies?

Directly or indirectly, it is ordinarily accentuated at the highest level of the hierarchical structure of these strategies - at the level of vision. At lower levels, in systems of objectives, measures,

activities and instruments, the topic is included in individual strategies with varying degrees of specificity and complexity.

Q3: What typical measures, activities and specific instruments for the supporting innovation are set in the main development strategies of regional capitals?

Thirteen basic groups of specific objectives, measures, activities and instruments have been identified. These are based on the theoretical concept of innovations support within the regional innovation systems. The most important for the Czech regional capitals according to their frequency in the strategies are co-ordinated cooperation between participants in the innovation ecosystem, communication platforms and networking activities, and ensuring human resources for research, development and innovations.

Q4: With what degree of complexity is the topic of innovations support elaborated in the main development strategies of the regional capitals?

It was found that in a slight majority (7 cases) the topic is formulated in a systematic and specific form. A minority of strategies (5 cases) deal with the topic in partial form (with using of the limited extent of instruments or in too much general declarations). In only one case, the strategy does not include the topic of innovations support at all.

Q5: Does supporting innovations represent an important topic which is accentuated by the regional capitals in their main development strategies?

The results have shown that innovations support represents the important topic in the main development strategies of the regional capitals in the Czech Republic

The inclusion of the topic of innovations support in the main development strategies of regional capitals represents certain declarations of a future implementation of concrete actions. However, the question arises as to whether or not the declared actions will become real actions in the forms of specific projects or other activities.

In the context of the statement in the introductory literature review about the considerable problematics of implementing of municipal strategies in the Czech Republic, it can be supposed that also the topic of innovations support will be problematic within the implementation phase of the strategy.

Another important issue is the role of municipalities and other participants while implementing strategies. Strategic documents have, among other things, a coordinating function, seeking to harmonize the activities of several participants. Typical groups of specific objectives, measures, activities and instruments have been identified in the individual strategies, but it is not clear what role the municipality and other participants should play in their implementation.

The results of this research responded to important questions on the topic of innovations support from the perspective of regional capitals in the specific environment of the Czech Republic. The authors of the research shall continue to address this topic, which also has strong practical implications.

## **Acknowledgement**

The authors would like to thank the Internal Grant Agency of FaME for providing financial support to carry out this research. Funding was extended through: TBU No. IGA/FaME/2018/006 Evaluation and efficiency of additional training in companies (SME) in the context of financial resources.

## References

- Blažek, J., & Uhlíř, D. (2011). *Teorie regionálního rozvoje: nástin, kritika, implikace*. Prague: Karolinum.
- Bryson, J. M. (2011). *Strategic planning for public and nonprofit organizations: a guide to strengthening and sustaining organizational achievement*. San Francisco: Jossey-Bass.
- Cooke, P. (1992). Regional innovation systems: Competitive regulation in the new Europe. *Geoforum*, 23(3), 365-382. doi: 10.1016/0016-7185(92)90048-9
- Grebeníček, P. (2016). *Podpora podnikání a inovací v rámci strategického plánování regionálního rozvoje*. Zlín: Tomas Bata University in Zlín.
- Grebeníček, P., & Hájek, O. (2013). K tématu strategického plánování regionálního rozvoje. *Urbanismus a územní rozvoj*, XVI(4), 21-26. Retrieved from [https://www.uur.cz/images/5-publikacni-cinnost-a-knihovna/casopis/2013/2013-04/03\\_k%20tematu.pdf](https://www.uur.cz/images/5-publikacni-cinnost-a-knihovna/casopis/2013/2013-04/03_k%20tematu.pdf)
- Grebeníček, P. Hájek, O., Smékalová, L., & Danko, L. (2013). Support of business and innovations in strategic planning of regional development on the municipal level of the Czech Republic. *Acta Universitatis Agriculturae et Silviculturae Mendelianae Brunensis*, 61(7), 2143-2149. doi: 10.11118/actaun201361072143
- Habuda, M. (2013). *Hodnocení současné praxe strategického plánování rozvoje ve městech s více než 50 000 obyvateli na území České republiky*. Paper presented at the 13th Conference of Postgraduate Students and Young Scientists in Informatics, Management, Economics and Administration, Pardubice, Czech Republic. Pardubice: University of Pardubice.
- Ježek, J. (2014). Plánovací kultura v České republice na příkladu strategického plánování měst. *Trendy v podnikání: vědecký časopis Fakulty ekonomické ZČU v Plzni*, 4(4), 52-57. Retrieved from <http://www.fek.zcu.cz/tvp/doc/akt/tvp-4-2014-clanek-7.pdf>
- Ježek, J. et al. (2015). *Strategické plánování obcí, měst a regionů: vybrané problémy, výzvy a možnosti řešení*. Prague: Wolters Kluwer.
- Leigh, N. G., & Blakely, E. J. (2013). *Planning local economic development: theory and practice*. Los Angeles: Sage.
- Leydesdorff, L., & Etzkowitz, H. (1998). The Triple Helix as a model for innovation studies. *Science and Public Policy*, 25(3), 195-203. doi: 10.1093/spp/25.3.195
- Malmberg, A. (1997). Industrial geography: location and learning. *Progress in Human Geography*, 21(4), 573-582. doi: 10.1191/030913297666600949
- Maskell, P. (1998). Low-Tech Competitive Advantages and the Role Of Proximity: The Danish Wooden Furniture Industry. *European Urban and Regional Studies*, 5(2), 99-118. doi: 10.1177/096977649800500201
- Mařátková, K., & Stejskal, J. (2011). Znaky regionálních inovačních systémů. *Scientific Papers of the University of Pardubice – Series D*, 22(4), 133-142. Retrieved from <https://dk.upce.cz/handle/10195/42687>
- Novák, D. W. (2010). Strategické plány rozvoje obcí a regionů a hodnocení jejich kvality. In V. Klímová (Ed.), *XIII. Mezinárodní kolokvium o regionálních vědách*. Brno: Masaryk University.

- Řehoř, P. (2015). How to Improve Strategic Planning of Municipal Organizations in Czech Republic? *Procedia Economics and Finance*, 34, 521-527. doi: 10.1016/S2212-5671(15)01663-9
- Skokan, K. (2004). *Konkurenceschopnost, inovace a klastry v regionálním rozvoji*. Ostrava: Repronis.
- Slach, O., & Ježek, J. (2015). The State of the Art of Planning in Europe – Czechia. *disP - The Planning Review*, 51(1), 28-29. doi: 10.1080/02513625.2015.1038050
- Tödting, F., & Tripl, M. (2005). One size fits all?: Towards a differentiated regional innovation policy approach. *Research Policy*, 34(8), 1203-1219. doi: 10.1016/j.respol.2005.01.018
- Truneček, J. (2004). *Management znalostí*. Prague: C. H. Beck.
- Vozáb, J. (1999). *Strategické plánování rozvoje měst v České republice*. Prague: Charles University.

### Contact information

#### **Ing. et Ing. Martin Habuda**

Tomas Bata University in Zlín, Faculty of Management and Economics  
Mostní 5139, 76001, Zlín, Czech Republic  
E-mail: habuda@utb.cz  
ORCID: 0000-0002-5291-0466

#### **Ing. Mgr. Ladislav Kudláček**

Tomas Bata University in Zlín, Faculty of Management and Economics  
Mostní 5139, 76001, Zlín, Czech Republic  
E-mail: lkudlacek@utb.cz  
ORCID: 0000-0001-7375-0388

#### **doc. PhDr. Ing. Aleš Gregar, CSc.**

Tomas Bata University in Zlín, Faculty of Management and Economics  
Mostní 5139, 76001, Zlín, Czech Republic  
E-mail: gregar@utb.cz  
ORCID: 0000-0001-9939-5222

doi: 10.7441/dokbat.2019.030



# LEGAL BASES FOR THE GDPR IMPLEMENTATION IN MARKETING

*Lenka Hanáková*

## **Abstract**

Business entities carrying out marketing activities are among those which are fundamentally affected by the protection of personal data provided by the GDPR Regulation. Personal data is part of a personal identity and a very valuable and strategically important commodity these days. The importance of this legislation therefore is that it unifies the protection of personal data of individuals across the EU, it is directly applicable legislation. Business entities work with personal data from existing or potential customer when implementing marketing activities. The successful application of GDPR to marketing of business entities assumes a very good knowledge of this legislation and the ability to apply it correctly to the various processes and procedures that the business entity or marketing agency implements in the marketing field. All personal data controllers and processors are required to introduce technical, organizational and procedural measures in accordance with the GDPR. No matter how big the institution or business entity is. This subject is very broad. With a view to the limitation of this contribution, the main aim is therefore to present and discuss only some selected aspects of this issue (knowing that a number of other sub-themes will be worked in the future), to highlight a number of questions that arise in relation to this theme, to outline the potential direction and methods of the future research.

*Keywords: Marketing, GDPR, personal data, controller, pseudonymization, anonymization*

## **1 INTRODUCTION**

The European Data Protection Regulation (hereafter referred to as GDPR or GDPR Regulation) became applicable as of 25 May, 2018, in all member states for any company that stores or processes personal information about EU citizens within EU states. Voss (2014) notes that despite the fact that the European Union had legislation in the area of data protection, yet there were reasons for change. The choice of a regulation as the EU legislative instrument was made, because regulations will be in force in the same form in all of the member states of the European Union. He also points to the support of uniformity of law in the EU, which contrasts with the differing ways of implementation of Directive from 1995 in the various EU member states. Similarly, Tankard (2016) states that “since it is a regulation, not a directive, compliance is mandatory, without the need for each member state to ratify it into its own legislation”. In addition, he points to an important fact, namely that “the GDPR expands the scope of data protection so that it applies to anyone or any organization that collects and processes information related to EU citizens, no matter where they are based or where the data is stored”.

The collection and storage of personal data in the European Union is governed by the principles of minimal disclosure (data minimization principle) and of the duration of the minimum storage of personal data (conservation principle). These general principles were stipulated in the Data Protection Directive in a broad way and applied to any processing of personal data (ENISA, 2012). Although Directive 95/46/ES was repealed as a result of the adoption of the GDPR, according to Recital 9 of the GDPR, its objectives and principles remain sound. However, there is still a widespread public feeling that there are risks in relation to the protection of personal data of individuals, particularly with regard to activities carried out online.

The GDPR Regulation constitutes a set of rules for the protection of personal data. These legal rules apply to any body that collects and processes the personal data of Europeans. This means that these rules also bind those companies and institutions outside the EU that operate in the European market. Put simply, any entity that works with the personal data of its customer, clients or suppliers and that monitors and analyses user behavior on the web when using apps or smart technologies must follow GDPR Regulation. To think that the GDPR Regulation represents a revolutionary change in privacy is inaccurate. In the Czech Republic, there was an act No. 101/2000 Coll., on the protection of personal data, which regulated personal data processing obligations. By this act Directive 95/46/EC was implemented into the Czech legal order. Although the obligation to implement this Directive had to be met by all EU Member States, there was a differing level of personal data protection between EU member states; it was due to differences in the implementation and application of this Directive. So what is the role of the GDPR Regulation? It is directly applicable in all EU member states, not necessary to implement it. The reason is to ensure a uniform level of protection for individuals across the EU (Recital 13 of GDPR Regulation). The GDPR refines personal data processing obligations, introduces some new institutes and rights, and also toughens the penalties stemming from breaches of them. EU states were required to adopt an implementing law to specify more than 50 points that the GDPR places under the national jurisdiction of individual member states. The Czech Republic fulfilled this obligation with an annual delay. Act No. 110/2019 Coll., on the processing of personal data, came into effect 24. 4. 2019. He replaced the existing national law (Act No. 101/2000 Coll.).

This paper deals with selected aspects of GDPR in conjunction with marketing. The issue of GDPR is a very wide-ranging issue that takes a lot of time not only to gain knowledge of the content of this legislation, but especially to understand the processes. The author of this contribution proceeds from the assumption, that the level of burden imposed by the GDPR Regulation and the financial, organizational and staffing impacts will be perceived differently by business entities. This depends on the size of the business entity and its focus. Recital 13 of the GDPR Regulation explicitly mentions that “To take account of the specific situation of micro, small and medium-sized enterprises, this Regulation includes derogation for organizations with fewer than 250 employees with regard to record-keeping. In addition, the Union institutions and bodies, and Member States and their supervisory authorities, are encouraged to take account of the specific needs of micro, small and medium-sized enterprises in the application of this Regulation. The notion of micro, small and medium-sized enterprises should draw from Article 2 of the Annex to Commission Recommendation 2003/361/ES”.

Business entities, and in particular marketing agencies, are among those subjects whose marketing activities are heavily impacted by the GDPR Regulation. If these entities have performed responsibly the obligations laid down by national legislation before the GDPR took effect, then the GDPR does not necessarily represent a revolutionary change for them. Potůček (2017) states that the effects will be different in a small trading company that has a corporate website, but does not collect any e-mails to send newsletters, just only uses the contact form or cookies. Different impacts can be expected for a business entity that operates an e-shop, has multiple communication channels, sends out newsletters regularly, and uses remarketing or targeted advertising.

The main objective of this article, taking into account the broad scope of the whole issue of GDPR in conjunction with marketing, is to address some of the core and, for the purposes of this contribution, selected problems that business entities must take into account and may face.

The structure of the article is as follows. First, the article will address some of the basic legal concepts of the GDPR Regulation, such as personal data and why it is important to distinguish

when a personal data is involved and when it is not. The difference between controller and processor will be explained as this distinction can cause problems and some uncertainty in practice, however this distinction is crucial for business entities – it is linked to the GDPR’s determination of obligations and especially the responsibilities involved. Another area of concern will be anonymization and pseudonymization, their benefits and potential risks to business entities in relation to the processing of personal data of individuals will be discussed. Secondly, possible targets of interest, potential direction and methods of the future research under PhD study will be identified.

This contribution is an initial step in the search for topics to be given particular attention within the planned focus group and subsequent qualitative eventually quantitative research.

## **2 BASIC LEGAL CONCEPTS OF GDPR REGULATION**

### **2.1 The importance of a subject’s position in the processing of personal data**

Veberová (2017) emphasizes, first and foremost, the need to understand the concept of personal data correctly and to distinguish correctly who is in the position of controller and who is in the position of processor. She considers these three things essential and primary, because it enables marketing activity managers to implement the next steps needed to comply with the GDPR Regulation.

Business entities undertake marketing activities to reach both potential and existing clients and to offer them their services or goods and convince them of the uniqueness of their offer. One way in which business entity can implement it, is through digital (on line) marketing. This may be implemented by the business entity itself as a body of rights through its employees, or the business entity can use the services of the marketing agency, then a contract must be concluded. In the first case, the business entity is in a position to both a controller and a processor of personal data. In the latter case, it is essential that there is a clear clarification of roles contractually between the business entity and the marketing agency. The GDPR Regulation in Article 4 (7) defines the term “controller” as follows: „Controller means the natural or legal person, public authority, agency or other body which, alone or jointly with others, determines the purposes and means of the processing of personal data “. Paragraph 8 of the same provision contains the definition of “processor”: „Processor means a natural or legal person, public authority, agency or other body which processes personal data on behalf of the controller “. Finally, it must be taken from how the GDPR Regulation defines “processing”, i.e. what all activities are covered by this legal concept. The answer is found in paragraph 2: „Processing means any operation or set of operations which is performed on personal data or on sets of personal data, whether or not by automated means, such as collection, recording, organization, structuring, storage, adaptation or alteration, retrieval, consultation, use, disclosure by transmission, dissemination or otherwise making available, alignment or combination, restriction, erasure or destruction”.

The processor of personal data, according to the GDPR, is therefore an entity (person, authority, business entity) that processes personal data on behalf of the personal data controller. It could be, for example, an accounting company, a payroll processing company or a customer data processing marketing company. A written personal data processing contract between the processor and the controller is necessary. However, it should be stressed that the controller has still a responsibility for processing personal data. Simply put, the controller is responsible for his processors and this responsibility cannot be transferred to another entity. This is also why the controller should be very cautious when selecting a processor and why he should select only such an entity that provides sufficient guarantees for the safe processing of personal data. The

importance of the written contract is reflected, *inter alia*, in the fact that it defines the activities and operations that the processor may carry out, in other words, which he has been instructed to carry out by the controller. The controller is the one with the main responsibility for processing personal data. However, even the processor has obligations, e.g. he is required to properly safeguard the processing of personal data and to comply with adequate organizational and technical measures to prevent personal data being compromised. In addition, the processor has another very important obligation. If he finds out, that a controller is in breach of the obligations laid down by GDPR, he must bring that fact to the controller's attention while stopping processing personal data. If he fails to do so, the processor shall be liable for the damage caused to the personal data subjects together with the controller.

The GDPR Regulation brought a new legal concept into the Czech legal order – joint controllers. However, this legal term has existed in European law for many years. This term has already been regulated by Directive 95/46/ES, but Czech legislators did not use the option of extending the definition of a “controller” to include more than one entity when implementing that directive into national law. According to the article 26 of GDPR applies as follows: “Where two or more controllers jointly determine the purposes and means of processing, they shall be joint controllers. They shall in a transparent manner determine their respective responsibilities for compliance with the obligations under this Regulation, in particular as regards the exercising of the rights of the data subject and their respective duties to provide the information referred to in Articles 13 and 14, by means of an arrangement between them unless, and in so far as, the respective responsibilities of the controllers are determined by Union or Member State law to which the controllers are subject. The arrangement may designate a contact point for data subjects”.

Considering the GDPR Regulation, it is therefore necessary to assess correctly situations where more than one entity is involved in the processing of personal data. The definition character of joint controllers within the meaning of Article 26 (2) of GDPR is a joint determination of the purposes and means of processing. However, the GDPR Regulation does not specify in more detail what can be included in the concept of “joint determination”. In this context, Nemčková (2019) states that answers to the interpretative and application ambiguities could be brought by the latest EU Court of Justice (SDEU) case law to the concept of “controller” enshrined in the Article 2 (d) of Directive 95/45, which is defined in it as a “natural or legal person, public authority, agency or any other body which, alone or jointly with others, determines the purpose and means of processing personal data”. The interpretation of this concept is particularly relevant from the point of view of the direct application of the relevant GDPR provisions both at European and national level. Nemčková (2019) cites two SDEU decisions as an example in this context, namely decisions C-210/16 and C-25/17. The term “controller” is to be interpreted broadly to ensure effective protection of the data subject and their right to privacy, according to the court. She notes that when applying this interpretation of the SDEU to an article 26 of GDPR, it can be concluded that the “joint determination” of purpose and means is to be interpreted extensively. She cites paragraph 43 of the C-210/16 judgment, which states that “it cannot necessarily be inferred from the existence of joint liability that individual operators should bear the same proportion of responsibility. On the contrary, those operators may be involved at different stages of that processing and to varying degrees, so that the degree of responsibility of each of them must be assessed in the light of all the relevant circumstances of the present case”. However, as Nemčková points out, the court did not specify what may be the relevant circumstances from the point of view of the court's or supervisory authorities' decision. That this is an interesting and important issue from the point of view of the recipients of the legislation, shows the fact, that the issue of a broad interpretation of the term “joint controllers” and the subsequent responsibilities was addressed by EU Advocate General Michal

Bobek (Opinion of the Advocate General, 2018). In this opinion, the Advocate General points to the practical problem of a broad interpretation of the SDEU, according to which there is no need for each of the controllers to have access to personal data. Such a controller is then responsible for processing, but he cannot effectively provide access to personal data to any data subject. Although that opinion concerns the interpretation of Directive 95/46, the Advocate General points out that the interpretation will also have an impact on the application of Article 26 of GDPR, in particular paragraph 3 – where that provision governs solidary liability of joint controllers and essentially rules out the conclusion that controllers need not have the same liability. He emphasizes the interpretation of the term “processing”, which focuses on processing stages, respectively acts or sets of personal data operations. He is of the opinion that the administration should be assessed in relation to specific processing operations. In relation to the responsibilities of joint controllers, he notes in point 101 of the opinion that “As regard a particular processing act, the (joint) controller is responsible for such an act or set of acts for which he shares or co-determines the purposes and means. On the other hand, such a person cannot be held liable for the preceding stages or the subsequent stages of the entire processing chain, in respect of which he could not determine the purpose or means of processing”.

With regard to the above, it is clear that determining the status of the entity is absolutely essential. The reason is simple, the entity may not only be in a position of controller, or in the position of processor, but under the GDPR Regulation there is even a “joint controllers”. As Nemčková (2019) points out, the concept of Article 26 of GDPR is based on the assumption that individual entities will be aware of being joint controllers and, based on this knowledge, they will define tasks and responsibilities between themselves. At the same time, however, she points to the practice when the entities have difficulty evaluating the position they are in, even in relation to the processing they carry out themselves. Therefore, determining the reciprocal position they are in when involving other entities in relation to the specific processing of personal data is even more challenging. A common question for obligors is whether one of them is the processor of the other, i.e. the person who processes personal data for the controller (according to his instructions). However, the relationship between the different entities involved in the processing can be diverse, such as the controller – controller relationship, the controller – processor relationship, the relationship of the joint controllers, or the relationship of the controller and the person in charge of processing in the controller’s business, typically the employee.

The correct determination of who is in what particular position (controller, processor, and joint controller) when processing the personal data of individuals is extremely important. Indeed, there is a threat of a penalty (administrative fines under the GDPR are very high – see Article 83 (4), (5), (6) of the GDPR Regulation) and liability for damage caused by processing that infringes the GDPR. This is not just about responsibility in public law, but also in private law. If a business entity in a position of controller or processor demonstrates that he is in no way liable for the event that led to the harm, he is absolved of liability for the harm. The existence of this mitigating ground for absolving liability laid down by the GDPR is absolutely essential for business entities. It means certainty for them to be able to demonstrate that all their activities relating to the personal data of individuals that they carry out in connection with the marketing activities are in line with the GDPR. On the other hand, however, this places considerable responsibility on the business entity in determining and securing all obligations and elaborating all procedure to comply with the requirements of the GDPR. Clarifying the roles in relation to the processing of personal data is crucial in determining the subsequent liability where a breach of a particular legal obligation under the GDPR is found.

## 2.2 Personal data, anonymization, pseudonymization

Esayas (2015) stresses that understanding the concept of “personal data” is at the center of discussions about the protection of personal data. At the same time, he adds, this is so because the “processing” of “personal data” is the main criteria for the applicability of data privacy rules.

Nulíček et al. (2017) states that the personal data is not only the identifier itself as a birth number or name and surname, but any information about the person associated with that identifier (e.g. a complete record in the personnel system that relates to a particular employee). Similarly, in the case of a business entity, it may be a complete record in a database relating to a particular customer. However, Nulíček et al. stresses that even if we remove all direct identifiers from the record as birth number or name and surname, the specific record may not stop containing personal data if the relevant data can be assigned to a particular individual indirectly. With regard to the possibility of indirect identification, according to Recital 26 of GDPR – into account should be taken of all the means reasonably likely to be used, such as singling out, either by the controller or by another person to identify the natural person directly or indirectly. However, the question is how to determine whether the use of means to identify a natural person can be reasonably assumed. Again according to Recital 26 of GDPR – all objective factors should be taken into account, such as the cost and the amount of time that identification will require, taking into consideration the available technology at the time of the processing and technological developments. Nulíček et al. (2017) points to the fact, that the controller should focus on the specific means by which an individual can be retrospectively identified from anonymized data, and also taking into account how costly this retrospective identification is, whether it requires extensive know-how and what is the likelihood that it will occur. It would certainly be much easier for managers of marketing activities if there was a clear and precise definition of the term “personal data”. Unfortunately, the legislation is somewhat ambiguous in this sense, as it regards as a “personal data” any information that may lead to the identification of the person.

As Esayas (2015) appropriately complements, identifiability implies that identification has not happened yet but is possible, for example, by combining the information being processed with other information. So it means that the mere possibility of associating certain information with particular individual is sufficient. This wording places a great responsibility precisely on marketing activity managers, who must be able to evaluate when it will be a personal data and when it will not. This decision is subsequently tied to the obligations laid down by the GDPR Regulation. However, what is personal data in case of one individual, because it makes it clearly identified, may not yet be personal data for another natural person. A crucial and decisive factor is whether it is possible to identify a specific person from the data associated with the information. From this point of view, the name of a person itself, or possibly an email in conjunction with a name, will not be a personal data unless it is possible to identify a particular person. A personal data may be just one, provided that it enables a particular individual to be identified in itself. But it will often be more data that only together will allow a specific person to be identified. It doesn't matter if the controller has this data in one database or in multiple separate databases or lists. While the definition of personal data is relative broad, it must be taken into account that the application of the GDPR Regulation only occurs when it is processed.

Only natural persons have the right to personal data protection under GDPR Regulation. Therefore, all legal persons, public authorities and other institutions are excluded from protection. However, their employees are affected by that protection. Based on the above, marketing activity managers must always take into account the existence of GDPR Regulation

when using these data to contact a natural person, or if any of the personal data are published online, e.g. in the context of a content marketing.

Personal data collected by the controller, whether alone or through a marketing agency, for a particular purpose may be deliberately and specifically anonymized or pseudonymized. The question is whether these processes, i.e. anonymization and pseudonymization relating to the personal data of individuals, are subject to the GDPR regime and what this means for marketing activity managers as a result.

Oswald (2014) has already discussed the importance of anonymization of personal data as a method of minimizing privacy risks and increasing trust. She considers anonymization to be important because it enables secondary use of personal data while minimizing the privacy risk to individuals.

Ohm (2009) says that the anonymization plays a central role in a modern data handling, it forms the core of standard procedures for storing or disclosing personal information. Ohm points out that data controllers anonymize to protect the privacy of data subjects when storing or disclosing data. For various reasons, they may want to disclose the data to another entity, citing the big banks as an example. These may want to share some data with their marketing departments, but only after anonymizing to protect customers' privacy. However, Ohm also points to a potential problem related to possible re-identification. It is based on the fact that by anonymizing data, a data controller gives notice of his intent to protect the privacy of his data subjects, who may rely on this notice when consenting to provide him their data. He draws attention to the fact that re-identification can happen completely in the shadows. The question then is how in practice do detect an act of re-identification. In this context, he outlines a possible eventual example concerning Amazon.com. Indeed, it is really a fictional example, when Amazon.com anonymizes its customer purchase database and hands it over to a marketing company. The marketing company will promise not to re-identify people in Amazon's database, but it knows that if it did, it could significantly increase profits. The question remains, if the marketing company breaks its promise and re-identifies, how Amazon or anyone else will ever know. So, according to him, a marketing company can make re-identification in secret and revenue gains may not be detectable for the vendor. Ohm admits that this problem could appear insurmountable, but he also cites possible solutions, such as a ban on re-identification by lawmakers with tougher sanctions and better enforcement or lawmakers can give citizens a private right of action against those who re-identify.

Esayas (2015) states that the term anonymization includes a number of techniques that aim at reducing the identifiability of individuals, and at the same time pseudonymization can be considered as one technique of anonymization. However, he distinguishes between these two terms, especially because of the different legal significance attached to different anonymization techniques under data privacy rules.

Nulíček et al. (2017) refers to the original Directive 95/46/ES, which contained a similar provision concerning the identification of a natural person as the GDPR, in particular its closer interpretation by the Court of Justice of the European Union in the Breyer case. As he points out, it follows from that decision that the possibility of identifying a particular person must be seen objectively, and if there is more than a hypothetical possibility that another person will make identification, the relevant data must be regarded as personal data. Thus, the specific conclusion of that decision was that the dynamic IP address collected by the website operator was a personal data item.

ICO (2012) says, that understanding anonymization means understanding what personal data is and to protect privacy it is better to use or disclose anonymized data than personal data. At the same time, it adds, that effective anonymization depends on understanding what constitutes

personal data. Information or a combination of information, that does not relate to an individual or does not identify an individual, is not personal data.

Nulíčet et al. (2017) argues that in practice, personal data will also be data that the controller adjusts so that they do not contain any more direct identifiers (e.g. by hashing technique) and then the controller passes them on to a third party for processing. The reason for that is the fact that the controller is able to make retroactive identification of data subjects based on the original data, if the original data had not been deleted. In that case, it will be pseudonymized data that is data protected by a security measure reducing the risk associated with the processing. However – these data are still subject to the GDPR regime. At the same time, he points to the ability of the controller to remove completely certain data from GDPR mode. In this context he speaks about anonymization, within which the data are adjusted in such a way that they cannot be assigned to a particular natural person, taking into account any means that can reasonably be assumed to be used by the controller or another person for the direct or indirect identification of the natural person.

Oswald (2014), referring to UK's Information Commissioner Office (2012) and its advice, stresses that determining whether personal data has been effectively anonymized involves an assessment of risk in order to ensure that the risk is "remote".

Anonymization consists in the removal of information that may lead to the identification of a particular person. In this process, personal data is removed from a document or database. This process, which is irreversible, makes it impossible to assign data in a document or database to specific individuals. This deletion must be done in such a way that no one in a given document or database can find and assign personal data back to a particular natural person. The result of anonymization is therefore a document, database or other media file, however the information contained therein is not attributable to specific persons. This procedure is very often used precisely in marketing in bulk data processing for statistical or evaluation purposes. It is essential for marketing activity managers that this procedure is not subject to GDPR Regulation. Anonymization may be accomplished by, for example, blacking out or blurring an anonymized part of a document or image. How ICO (2012) says anonymization helps organizations to comply with their data protection obligations whilst enabling them to make information available to the public.

There are undisputed positives of anonymization that business entities may feel in relation to the realization of marketing activities. The fact that anonymized data is exempt from the scope of the GDPR Regulation may provide sufficient reason for marketing activity managers to use anonymization in relation to customer personal data. Of course, this is not always possible, especially not in the case of direct marketing, where it is targeted at a particular individual. Nulíček et al. (2017), however, points out, that anonymization is not in practice a matter of a single operation. In this context, he refers to the opinion of WP 29 No. 5/2014 of 10. 4. 2014 on anonymization techniques. According to this opinion, full anonymization can only be achieved by combining multiple methods such as aggregation, permutation or "adding noise". Only by combining more such measures it can be achieved that it is not possible to separate an individual from the dataset, it is not possible to link different records relating to one person and it is not possible to infer information relating to one person from the dataset. In order to declare that personal data are anonymized, these three criteria mentioned must be met.

It should be stressed that pseudonymized personal data is not anonymized data. The consequence is that they are still subject to the GDPR Regulation. The essence of pseudonymization of personal data is the process of hiding the identity of a natural person. It means replacing the identification data of persons (e.g. names and surnames) with some insignificant identifier – a code (e.g. a number). The aim of this procedure is to protect data sets



with personal data so that this data cannot be paired with specific people. Only a person who has the necessary files, which are deliberately kept separately, can correctly assign sensitive data to specific individuals. It is therefore a reversible process, i.e. that it is possible to reconstruct the original file, but it is necessary to have both parts of it to do so. Marketing activity managers always collect personal data with some purpose. The aim may be, for example, to identify target group's preferences for subsequent adaptation of marketing activities. Pseudonymization is therefore mainly used for the protection of personal data. It makes it impossible to assign a particular person to specific data, which contributes to protection against wanted or unwanted abuse.

The GDPR Regulation in Article 4 (5) defines the term "pseudonymization" as follows: "Pseudonymization means the processing of personal data in such a manner that the personal data can no longer be attributed to a specific data subject without the use of additional information, provided that such additional information is kept separately and is subject to technical and organizational measures to ensure that the personal data are not attributed to an identified or identifiable natural person".

Mourby et al. (2018) addresses the question whether the GDPR is expanding the scope of personal data by introducing the term "pseudonymization". He argues that if all data that was "pseudonymized" in the conventional sense (e.g. through coding) should be considered personal data, it would have serious implications for research. Even when he is referring in particular to research relating to data that is collected and stored by public authorities, this can be extended, in the opinion of the author of this contribution, to any research. In this case, marketing research conducted by business entities to target well their marketing activities. Mourby et al. (2018) argues that the definition of pseudonymization does not expand the category of personal data. This definition within the GDPR is not intended to determine whether data is personal data, as all data falling within this definition is personal data. However, he points to Recital point 26 of the GDPR and the requirement contained therein of a reasonable assumption of the use of means to identification of a natural person. He sees this as a test of whether the data is personal. Mourby is of the view that this leaves open the possibility that data that has been pseudonymized in the conventional sense could be anonymized. He also admits that there may be circumstances where data that has undergone pseudonymization within one organization could be anonymous to a third party. The definition of pseudonymization is not to be used, according to his conclusions, to determination whether the data are personal data according to GDPR, as it is indeed clear that the data to which pseudonymization applies are and remain personal data. Instead, point 26 of Recital of GDPR should be used to determine whether the data is personal. The question is therefore whether there are any means that can reasonably be used to identify individuals.

Tsalakis et al. (2016) highlights in the context of pseudonymization that "The additional information needs to be kept separately by the data controller, who must take all appropriate technical and organizational measures to ensure non-attribution". He also points to the fact that "Although recital 28 acknowledges that pseudonymization can reduce risks of personal data breaches, under recital 26 pseudonymized data should still be considered as personal data as they include information relating to identifiable natural persons". He therefore concludes that pseudonymized data are not exempt from GDPR and in order for any dataset to be considered pseudonymized within the meaning of GDPR it shall not be possible to attribute information to identifiable individuals.

ICO (2012) notes that the definition of "personal data" can be difficult to apply in practice, this is especially because, that the term of "identify" and therefore "anonymize" is not straightforward because individuals can be identified in a number of different ways. Firstly, it

may be a direct identification, where someone is explicitly identifiable from a single data source, as for example a list including full names, secondly it may be an indirect identification, where two or more data sources need to be combined for identification to carry out. The problem is that there may be other data somewhere with which a third party will be able to realize re-identification. Apparently, therefore, ICO (2012) says, that it may actually be difficult to determine whether the data has been anonymized or is still personal data.

### **3 RESEARCH GAP AND OUTLINE OF THE RESEARCH**

It is clear from the literary research of selected problem areas relating to the subject that these are topics that are not only important and essential in the field of personal data processing, but also not always quite clear. Thus, they are linked to a number of other follow-up issues that, however, marketing activity managers have to cope with in practice.

It should be stressed that this contribution is only a small illustration of the sub-topics that relate to the author's main theme, namely – what are the changes in the approach of business entities to marketing after GDPR Regulation took effect. Since the author of this contribution is at the very beginning of the PhD study and research work, the contribution is deliberately focused on the legal bases for the implementation of GDPR in marketing. However, it should be added that, considering the limitation of the range of this contribution, it is not possible to address all the sub-topics that come into account. Nevertheless, the author will certainly address them in other future research work.

With respect to the literary research related, at the moment and for the purposes of this contribution, indeed, really only to a few selected sub-topics, it is evident the existence of a research gap. The research intention therefore aims to fill this gap. The author's research intention is to analyze and evaluate how business entities (small, medium and large) perceive these sub-themes in practice when implementing marketing activities, how they deal with them in practice, and what implication it has for them, whether in the financial, organizational or staffing fields.

The content of this contribution may lead to the following research questions. 1) Which key marketing activities were affected by the GDPR Regulation? A number of other partial research sub-questions will be answered as part of this research question. For example, whether business entities use anonymization and pseudonymization processes when processing personal data in connection with marketing activities. If so, what real problems they face. Whether they use these personal data processing processes to a greater extent after the GDPR has taken effect. In which marketing activities do business entities use anonymization and pseudonymization processes? Whether business entities have trouble clearly to identify, when implementing their marketing activities, what is a personal data item and what is not. If another entity is used to process personal data, or more than one entity is involved in certain processing of personal data – whether they perceive it easy to determine each other's roles and positions in processing and if not, how do they deal with it? The first research question leads logically to the second and third research question, namely: 2) what impact (financial, staffing, organizational, etc.) had a GDPR Regulation on management of marketing activities? 3) Is there a difference in the impact of GDPR on the management of marketing activities in small, medium and large business entities, if so, in what areas? The hypotheses will be formulated on the basis of literary research and implemented focus group. They will be confirmed or rebutted on the basis of the implementation of qualitative, or quantitative, research.

The intended procedure of the work and methods in carrying out the research are shown graphically below (Fig. 1).

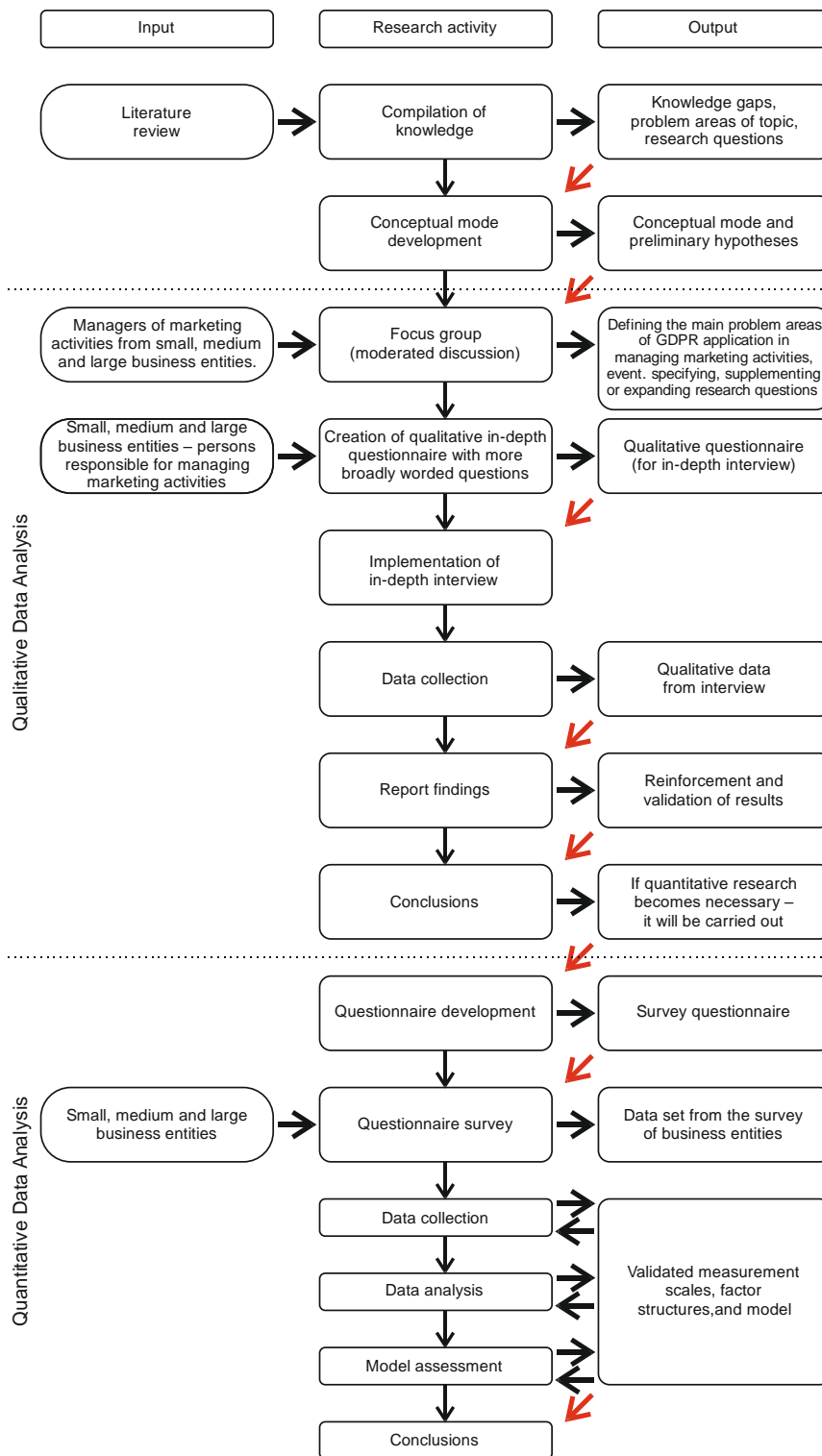

Fig. 1 – Procedure of the work and methods. Source: own research

## 4 CONCLUSION

Personal data is undoubtedly an important and integral part of an individual's personal identity. However, they represent a very valuable and strategically important commodity for a number of entities. The GDPR regulation seeks to balance these two, largely conflicting interests. The protection of personal data is gaining a new dimension. Business entities need personal information for their marketing activities to target on a specific entity. Individuals very often

provided their personal data without thinking, for example when shopping online, when registering for various applications and services. The GDPR seeks to respond to the huge technological changes that have occurred since 1995, when the Data Protection Directive 95/46/ES came into force.

Since the author of this contribution is only at the very beginning of the PhD study, the main aim of this paper is to highlight the complexity and breadth of the whole issue – i.e. marketing in conjunction with the GDPR, under which, for this contribution, only some sub-topics have been selected, such as the issue of the definition of personal data, the issue of determining a subject's position in the context of personal data processing, pseudonymization and anonymization issues.

This contribution presented, taking into account its scope limitation, only some selected aspects of this theme, highlighted some of the questions that arise in relation to this topic, outlined the potential direction and methods of future research.

## References

- Act No. 110/2019 Coll., on processing personal data. *Collection of laws of the Czech Republic*, 47, 890-911.
- Act No. 101/2000 Coll., on the protection of personal data and amending certain laws. *Collection of laws of the Czech Republic*, 32, 1521-1566.
- Data Protection Working Party. (2014). *Opinion No. 5/2014 on anonymisation techniques*. Retrieved from <https://www.pdpjournals.com/docs/88197.pdf>
- Directive 95/46/EC of the European Parliament and of the Council of 24 October 1995 on the protection of individuals with regard to the processing of personal data and on the free movement of such data
- ENISA. (2012). Study on data collection and storage in the EU. In *European Network and Information Security Agency*. Retrieved from <https://www.enisa.europa.eu/publications/data-collection>
- Esayas, S. Y. (2015). The Role of Anonymisation and Pseudonymisation under the EU Data Privacy Rules: Beyond the 'All or Nothing' Approach. *European Journal of Law and Technology*, 6 (2), 1-23. Retrieved from <http://ejlt.org/article/view/378/568>
- ICO. (2012). *Anonymisation: managing data protection risk code of practice*. Retrieved from <https://ico.org.uk/media/1061/anonymisation-code.pdf>
- Judgment of the Court. (2016). *Case C-582/14*. Retrieved from <https://eur-lex.europa.eu/legal-content/EN/TXT/?uri=CELEX%3A62014CJ0582>
- Judgment of the Court. (2018a). *Case C-210/16*. Retrieved from <http://curia.europa.eu/juris/celex.jsf?celex=62016CJ0210&lang1=cs&lang2=EN&type=TXT&ancre=>
- Judgment of the Court. (2018b). *Case C-25/17*. Retrieved from <http://curia.europa.eu/juris/celex.jsf?celex=62017CJ0025&lang1=cs&lang2=EN&type=TXT&ancre=>
- Mourby, M., Mackey, E., Elliot, M., Gowans, H., Wallace, S. E., Bell, J., Smith, H., Aidinlis, S., & Kaye, J. (2018). Are pseudonymised data always personal data? Implications of the GDPR for administrative data research in the UK. *Computer Law & Security Review*, 34(2), 222-233. doi: 10.1016/j.clsr.2018.01.002

- Nemčková, I. (2019). K odpovědnosti společných správců. In *Epravo.cz*. Retrieved from <https://www.epravo.cz/top/clanky/k-odpovednosti-spolecnych-spravcu-108827.html>
- Nulíček, M., Kovaříková, K., Tomíšek, J., & Švolík, O. (2017). GDPR v otázkách a odpovědích. In *Bulletin-Advokacie.cz*. Retrieved from <http://www.bulletin-advokacie.cz/gdpr-v-otazkach-a-odpovedich?>
- Ohm, P. (2010). Broken Promises of Privacy: Responding to the Surprising Failure of Anonymisation. *UCLA Law Review*, 57(6), 1701-1777. Retrieved from <https://www.uclalawreview.org/pdf/57-6-3.pdf>
- Oswald, M. (2014). Share and share alike? An examination of trust, anonymisation and data sharing with particular reference to an exploratory research project investigating attitudes to sharing personal data with the public sector. *Journal of Law, Technology and Society*, 11(3), 246-272. doi: 10.2966/scip.110314.245
- Opinion of advocate general. (2018). *Case C-40/17*. Retrieved from <https://eur-lex.europa.eu/legal-content/CS/TXT/HTML/?uri=CELEX:62017CC0040&from=EN>
- Potůček, J. (2017). E-mailly, cookies, remarketing: Jak vyřešit GDPR na webových stránkách? In *Obsah na dosah.cz*. Retrieved from <https://www.obnd.cz/e-mailly-cookies-remarketing-jak-vyresit-gdpr-na-webovych-strankach.html>
- Regulation (EU) 2016/679 of the European Parliament and of the Council of 27 April 2016 on the protection of natural persons with regard to the processing of personal data and on the free movement of such data, and repealing Directive 95/46/ES.
- Tankard, C. (2016). What the GDPR means for businesses. *Network Security*, 2016(6), 5-8. doi: 10.1016/S1353-4858(16)30056-3
- ÚOOÚ. (2018). *GDPR and direct electronic marketing*. Retrieved from <https://www.uoou.cz/gdpr-a-primy-elektronicky-marketing/d-30715>
- ÚOOÚ. (2017). *Controller, Processor*. Retrieved from <https://www.uoou.cz/7-spravce-zpracovatel/d-27278>
- Veberová, L. (2017). GDPR: Již včera bylo pozdě aneb Co je to za novoty. In *Obsah na dosah.cz*. Retrieved from <https://www.obnd.cz/gdpr-jiz-vcera-bylo-pozde-aneb-co-je-to-za-novoty.html>
- Voss, G. W. (2014). Looking at European Union Data Protection Law Reform Through a Different Prism: The Proposed EU General Data Protection Regulation Two Years Later. *Journal of Internet Law*, 17(9), 12-24. Retrieved from <https://ssrn.com/abstract=2567624>

## Contact information

### Mgr. Lenka Hanáková

Tomas Bata University in Zlín, Faculty of Management and Economics

Mostní 5139, 76001, Zlín, Czech Republic

E-mail: [lhanakova@utb.cz](mailto:lhanakova@utb.cz)

ORCID: 0000-0002-2242-7588

doi: 10.7441/dokbat.2019.031

# ASSESSING THE DISSIMILARITIES OF GAME MECHANICS ON ALBANIAN WORKING-CLASS CONSUMERS

*Fortesa Haziri, Fortune Nwaiwu, Miloslava Chovancová*

## **Abstract**

The increase in popularity of games and their attendant impact on player behaviour has led to the transformation of game elements in line with non-game contexts. The process of adding game elements in non-game context has been defined as gamification. Due to digitization, consumers are exposed to a wider range of information through their use of technological devices and social media. Therefore, gamification is seen as innovative engaging and motivating set of activities that influence purchasing dispositions of consumers. Due to the successful usage of gamification in numerous areas, this study was aimed at exploring the game mechanics differences for employed consumers who purchase via social media (s-commerce). Using a survey as part of the research design, a questionnaire was employed for data collection, 183 respondents participated completed the questionnaire, and the data collected was used to perform the non-parametric test, Chi-Square test for independence has been employed to describe and explore the differences. The results revealed that points, rewards and badges offered by the s-commerce retailer as factors that influence the purchase frequency of consumers are significantly differ based on the working sector for employed consumers. The study provides substantial evidences for retail businesses regarding game mechanics elements as purchasing motivator.

*Keywords:* game mechanics, gamification, purchase, social media, user behavior, employees

## **1 INTRODUCTION**

Purchasing via social media (s-commerce) has become an interesting research field. Moreover, to create a fun and enjoyable purchasing process game element may be employed. According to Gatautis et. (2016), the term of gamification was first used in sometime around 2002, but it was not until 2010 that the concept of gamification gained popularity and received greater interest, it attracted the attention of game creators who were interested in using gaming techniques in increasing players' engagement. Coincidentally, the concept has now received tremendous interest from stakeholders in the business world. Elements of e-games are often adapted and employed in real-life non-game environments as factors for engaging and motivating consumers. Gamification involves the adoption and incorporation elements associated with games as means of motivating, engaging and influencing the consumers' purchase and consumption behaviors, this is achieved by ensuring that the experience of the consumer becomes more pleasurable and exciting. The exploration of gamification is not restricted to the domain of consumer behavior. It has found successful applications in fields as diverse as education and training, marketing, social awareness, sales and human resources. (Calderón, Boubeta-Puig, & Ruiz, 2018). Presently, the internet has enhanced the usage of technology. Also, the daily use of social media platforms such as Facebook, YouTube, Twitter, Instagram has been shown to have an impact on the communication process between the end-users and technology devices (Decker & Trusov, 2010). According to Internet World Stats (2018), there are over 4 billion Internet users globally as at June 30, 2018.

Hsu and Chen (2018) argue that gamification has an effect on retention and customer loyalty; however, they stated that customers should first be engaged in playful experiences. Hence,

embracing gamification can be a marketing and business strategy applied to increase customer engagement and loyalty. Purchasing transcends the basic need for a product or service. Purchasing motivation is also evoked by factors such as passable play, social collaboration, and economic reasoning. The stated reasons are valid and impact the amount of money spent on the in-game environment. Furthermore, the designers apply unreal limitations and obstacles along with the social collaboration impact the amount of money spent on the in-game environment (Hamari et al., 2017). Also, the in-game environment enables consumer engagement and it is potentially linked to the consumers' psychological engagement and behavioral engagement levels. The key pillars for psychological engagement are listed as game satisfaction, game customization and social collaboration (Cheung, Shen, Lee, & Chan, 2015).

Models and elements of gamification have been studied by scholars; the studies differ according to various fields. For research purposes, the MDA framework has been considered as the most suitable for researching gamification in relations to issues such as consumer behavior. According to the MDA (acronym for game mechanics, dynamics, aesthetics) framework (J. T. Kim & Lee, 2015; Werbach & Hunter, 2012), gamification elements are game mechanics, game dynamics and aesthetics/emotions. The mentioned components were employed in the design of the questionnaire used for this study; the questionnaire was distributed to respondents in the Republic of Albania (hereinafter: Albania). Game mechanics are described as the rules, rewards, instruction and the limits for players to be followed. Those rules can be applied to online purchases as well.

Despite the high number of published guidelines and broad research, the gamification and game mechanics power for engaging and motivating consumers in developing countries has not been sufficiently explored which leaves a lot of gap within scientific literature. Due to lack of studies regarding game mechanics appliance, the study aims to fill this gap in theoretical and practical scope by assessing the dissimilarities of game mechanics on Albanian working class consumers. Furthermore, the research seeks to study the differences within working sector among Albanian citizens who use social media for purchasing purposes. By the same token, the authors did not find significant evidence to indicate that a study regarding the influence of game mechanics for social media purchasers has been investigated, notably within the context of developing countries.

## **2 LITERATURE REVIEW**

The increasing popularity of social media platforms, such as Facebook, Instagram and Twitter are significantly influencing consumer purchasing behavior. It is now common for users of these platforms to share product information with those within their network. Also, these consumers are encouraged by social media features to articulate their affinity or dislike towards products and services. They may also "consult their social community to seek advice in their purchasing decisions" and through social communities' consumers have the potential to affect the buying decisions of much larger communities (Baethge, Klier, & Klier, 2016; Shin, 2013). There are several factors proposed by researchers as catalysts of the growth of s-commerce especially among consumers in the working class sector of social demographics. Some of these factors include - rising trust levels attributable to the impact of micro-influencers; the preponderance of video and its impact on subtle, indirect influence of consumer choices; conversation through channels such as email and messenger apps are increasingly leading to an uptake of s-commerce; and social media interactions leads to an ever increasing level of impulse purchases online. There are numerous examples of successful use case of s-commerce such as Marvel studios selling movie tickets with Social Commerce and Nike's partnership with Snap through which it promoted the new Air Jordan III "Tinker", and after an NBA All-Star game,

the shoes were sold out in a record 23 minutes (Baethge et al., 2016; S. Kim & Park, 2013; Olbrich & Holsing, 2011).

In the quest to apply the concept of gamification, there has been various models that have been proposed among different domains. Calderón, Boubeta-Puig and Ruiz (2018) adopted the Model-Driven Engineering (MDE) and Complex Event Processing (CEP) technology (MEdit4CEP-Gam) model to investigate the stages of origination, application and also monitor the applicable strategies of gamification. Gatautis et al. (2016) compared the SOR model against the pyramid of gamification proposed by Werbach and Hunter (2012). The authors found substantial uniformity between gamification elements and SOR model. However, no empirical research has been conducted that sheds light on evidence regarding similarities within the model. Rahman et al. (2018) established a framework by using gamification elements dynamics, behavior, component and aesthetic. This model canvas method was designed for cloud computing environment to persuade teachers on sharing the lessons of gamification. Kim and Lee (2015) used the attributes of game design, the features of learning games, the ARCS (attention, relevance, confidence, and satisfaction) and MDA framework to constitute the dynamical model for gamification of learning. The MDA framework is made up of a group of three elements, they are: game mechanics, game dynamics and aesthetics.

Part of MDA framework are game mechanics. Game mechanics has found extensive use within business education for generation Y. The results of the study highlight the differences between the groups where game mechanics were deployed and those that did not benefit from such deployment. Also, there was a noticeably better performance by students in the group where game mechanics were deployed, the level of collaboration and participation among students in this group was higher, there was also noticeable higher level of expression of positive emotional reactions, and willingness to share further opinions and comments concerning the class experience (Martin Poole, Kemp, Patterson, & Williams, 2014). The class that did not use game mechanics recorded lower outcomes when compared to gamified classes. In the healthcare sector, game mechanics have resulted in improvements in patient engagement by creating challenging, entertaining, and improvements in how patients socialize (Hammedi, Leclerq, & Van Riel, 2017). Nour, Rouf and Allman-Farinelli (2018) have studied the impact of game mechanics on engaging young adults (18-34 years old) on improving their consumption of vegetables. Overall, the study findings confirm that the application of mobile-gamified elements combined with the usage of social media has remarkable impact on improving the vegetable intake of this focus group. Regarding the specific elements which were found to be the most effective is the act or reward system of “earning badges”. The study further highlights the importance of designing game elements by mentioning key features such as improved visual aesthetics, improvements in user experience (UX) via simplified design, credibility and relevance. Comparing two groups, one of the groups discussed the study environment and game mechanics were employed and the other group used a competitive discussion board game without game mechanics, whether the effect of presenting an activity as a game is relevant or not (Lieberoth, 2015). The sample study included students of age 20 to 43 years, and results indicated that vernacular and artifacts are psychologically powerful as game mechanics. For both groups, fun and enjoyment were significantly important, but motivation as a variable remained the same. In reference to age, a slightly negative correlation with relatedness was presented. The most important game mechanics to engage and motivate Taiwanese students of massive open online courses have been listed based on their level of importance as follows: virtual goods as gifts, redeemable points, team leaderboards, the Where’s Wally game, trophies and badges (Chang & Wei, 2016). The study concludes that Where’s Wally game has occurred to be significantly important for engaging students of the massive open online courses. Significantly important according to results have been identified as game points, levels, avatars



or virtual identity and badges (Scheiner, 2015). However, generally speaking, the participants of the study conducted by Scheiner (2015) ranked game mechanics as motivational factors for engaging consumers into idea competing provided by organizations.

The study by Hamari (2017) also confirms improvements in levels of engagement for participants when game mechanics are applied. The study was conducted over a two-year period, it utilized an experiment regarding the usage of badges in gamified utilitarian trading services as an incentive to influence user behavior. The results presented by the author corroborates other studies in regards to higher levels of significance for the end-users group after being introduced to gamification. The results from the study were in agreement with previous studies by researchers in the field (Hamari & Koivisto, 2014; Hamari & Tuunanen, 2014), where there was positive relationship between the features of the system and changes in user behaviors.

The impact of points, levels and leaderboards for an image annotation task, serve as external stimuli and it shows results for promoting level of performance only (Mekler, Brühlmann, Tuch, & Opwis, 2017). A more elaborate study focused on leaderboards was conducted with focus on employee motivation and engagement. Leaderboards have been proven to be important for simple tasks and extraordinary efficient for hardly-achievable goals and tasks (Landers, Bauer, & Callan, 2017). Furthermore, results from the study shows that points did not have an impact and on response accuracy. The successful appliance of game mechanics has been proven by numerous researchers as presented above. Concerning game mechanics impact on career awareness resulted significant due to the fact that game mechanics facilitated the communication with the system and provided additional options (McGuire, Broin, White, & Deevy, 2018). However, no research was found in terms of comparison between working classes. Consequently, to explore and investigate the differences, the following hypothesis have been proposed:

*H1: There is no association between the working sector and obtaining points, badges, and leader-boards when purchasing via s-commerce.*

*H2: There is no association between working sector and thrilling benefits obtained while purchasing via s-commerce.*

*H3: There is no association between working sector and forgetting unpleasant events when purchasing via s-commerce.*

*H4: There is no association between rewards, points and badges as motivators while purchasing via s-commerce and working sector.*

*H5: There is no association between perceiving shopping via s-commerce as fun and enjoyable process and working sector.*

### **3 METHODOLOGY**

This study was carried out in order to identify the working class differences for employed Albanian consumers who purchase via social media while game mechanics are considered. In order to fulfil the aim of the study, and provide information regarding game mechanics differences, a survey instrument has been chosen as part of the research design. Initially by considering deductive approach, articles related to game mechanics, purchasing via s-commerce and working class has been collected from Scopus and Web of Science which lead to problem formulation. Afterwards, the research was design in accordance with the theoretical knowledge as disposal. The questionnaire was used for data collection. The questionnaire contained five statements related to game mechanics initially designed in English and before

distributed for data collection in Albania, it was translated to the local Albanian language to ensure that respondents who do not speak English are also covered during the data gathering phase of the research. The five statements of game mechanics were previously used to investigate user behavior of Kosovar and the same statement without a changed have been part of this study (Haziri, Chovancová, & Fetahu, 2019; Haziri & Chovancova, 2018). To measure the level of agreement for the five statements, a five-point Likert scale (1 - Strongly disagree, 2 - Disagree, 3 - Neutral, 4 - Agree, 5 - Strongly agree) was employed as the measurement scale.

In order to examine the relationship between variables, chi-square has been employed. To analyses the data collected in Albania, the chi-square test is used. Chi-square is a non-parametric test which examines the association between categorical variables which are correlated in some population (Tabachnick & Fidell, 2014). From chi-square tests, the chi-square test for independence was employed to accomplish the research aim. The conditions which are two categorical variables, the sample size, two or more categorical or groups for each variable and the independence of observations to apply chi-square have been fulfilled. Besides, to measure the effect size chi-square independence test, Cramer's V has been observed. To explain Cramer's V the instruction from SPSS tutorial (2018) has been followed, therefore, the numbers between 0 and 1 has been used to provide explanation regarding the strength of the relationship between variables. After filtering 183 valid respondents were selected for further analyses. The data have been analyzed using SPSS version 23.

Tab. 1 – The game mechanics statements. Source: Haziri et al. (2019); Haziri & Chovancova (2018)

<b>Dimension</b>	<b>Item</b>	<b>Survey statement</b>
Game mechanics	GM01	By buying via social media, I am able to obtain points, badges, and leader-boards
	GM02	The benefits received for buying via social media are thrilling
	GM03	Purchasing via social media helps me forget unpleasant events and makes me feel better than others
	GM04	I felt motivated by the rewards, points and badges offered by sellers
	GM05	Social media make shopping a fun and enjoyable process

To perform the chi-square has been used game mechanics and the working class of respondents. After fulfilling the two initial criteria, which were to identify consumers who purchase via social media and are employed, the comparison of working sector differences when game elements are employed became the goal to conduct this research. Therefore, the authors aim to identify the game mechanics differences between Albanians consumers who purchase via social media and are employed.

#### **4 RESULTS AND DISCUSSION**

Albanian working sector is divided in three segments employees in public sector, non-agriculture private sector and agriculture private sector. Based on the reports provided by Institute of Statistics – Instat (2019) 14.97% of employed Albanian work in public sector and 85.02% work in private sector (non-agriculture and agriculture). In the survey conducted in Albania the majority of employed respondents (83.6%) work in private sector and the rest (16.4%) work in public sector. Therefore, the sample size is representative and corresponds with the data provided by the Institute of Statistics – Instat.

To perform the chi-square test has been gathering data in Albania from 183 respondents. The chi-square results for working sector are presented in Table 2.

Based on the literature review which lead to problem formulation, the hypotheses were designed considering the theoretical knowledge as disposal. The empirical test of hypotheses are

presented below which are expected to provide empirical evidences to support the hypotheses and fulfil the research aim.

Tab. 2 – Chi-Square test results (n=183, public sector=30, private sector=153). Source: own research

Items	Level of agreement	Public Sector		Private sector		Chi-Square		Cramer's V
		n	%	n	%	$\chi^2(4)$	p-value	Value
GM01	Strongly disagree	16	8.7	45	24.6	8.477	0.07	0.215
	Disagree	3	1.6	42	23			
	Neutral	6	3.3	45	24.6			
	Agree	1	2.2	18	9.3			
	Strongly Agree	1	0.5	3	1.6			
GM02	Strongly disagree	6	3.3	16	8.7	4.844	0.30	0.163
	Disagree	7	3.8	35	19.1			
	Neutral	7	3.8	44	24			
	Agree	10	5.5	45	24.6			
	Strongly Agree	-	-	13	7.1			
GM03	Strongly disagree	12	6.6	44	24	6.039	0.19	0.182
	Disagree	8	4.4	45	24.6			
	Neutral	2	1.1	36	19.7			
	Agree	5	2.7	21	11.5			
	Strongly Agree	3	1.6	7	3.8			
GM04	Strongly disagree	15	8.3	45	24.6	12.135	0.01	0.256
	Disagree	3	1.6	46	25.1			
	Neutral	3	1.6	35	19.1			
	Agree	6	3.3	22	12			
	Strongly Agree	3	1.6	5	2.7			
GM05	Strongly disagree	7	3.8	21	11.5	3.858	0.42	0.145
	Disagree	2	1.1	22	12			
	Neutral	8	4.4	51	27.9			
	Agree	8	4.4	43	23.5			
	Strongly Agree	5	2.7	16	8.7			

The chi-square test for independence indicated that no significant association between working sector and obtaining points, badges, and leader-boards  $\chi^2(4, n=183)$ ,  $p=0.07$ . Cramer's V resulted 0.215, signifying that the association strength between variables is medium. Regarding the association between the thrilling benefits of purchasing via social media and working sector, the results of the chi-square independence test failed to identify an association  $\chi^2(4, n=183)$ ,  $p=0.30$ . Cramer's V resulted with 0.163 signifying that the association strength between working sector and the thrilling benefits of purchasing via social media is small to medium. For purchasing via social media and forgetting unpleasant events and working sector differences, no association was identified  $\chi^2(4, n=183)$ ,  $p=0.19$ . Regarding Cramer's V, which resulted 0.183, the strength of the association is small to medium. Furthermore, the association between working sector and motivation elements such as rewards, points and badges offered by s-commerce retailers' resulted significantly different  $\chi^2(4, n=183)$ ,  $p=0.01$ . Also, Cramer's V resulted 0.256 indicates a small to medium association. Indicating that the motivations to purchase via s-commerce differ for Albanian consumers based on the working sector. No significant association was identified between working sector and consumers who consider shopping via social media as fun and enjoyable process  $\chi^2(4, n=183)$ ,  $p=0.42$ . Cramer's V resulted 0.145 signifying that the association is small to medium.

After analyzing the results of chi-square, the hypotheses H1, H2, H3 and H5 are supported due to the fact that the no association have been identified between working sector and obtainability of game mechanics when purchasing via s-commerce. On the other hand, H4 is not supported due to the fact that the association resulted significantly different between rewards, points and badges as motivators while purchasing via s-commerce and working sector. The authors aimed

to identify the differences between employed Albanian consumers who purchase via s-commerce when game mechanics are considered, however, differences have been identified between working sector and game mechanics motivators such as rewards, points and badges. Indicating that s-commerce retailers are advised to pay close attention regarding game mechanics motivation elements based on consumers working sector.

## **5 CONCLUSION**

The results of the current study depict the differences between game mechanics and Albania's working class consumers. Furthermore, the differences have been identified between game mechanics elements', rewards, points and badges, as motivators and working sector. Due to the fact that, the sample size corresponds with the reports presented by Institute of Statistics – InStat the results could be generalized for Albania citizens. For the rest of game mechanics elements, no association have been noticed. Therefore, regarding the benefits received for buying via social media are thrilling, forgetting unpleasant events by shopping via social media, and shopping via social media is fun and enjoyable process no differences were identified for game mechanics appliance despite working sector. Furthermore, the economy is highly depended in import goods, and it takes place in the group of the low-income country, namely consumers will be motivated by obtaining rewards, points and badges regardless working sector.

The aim of the research was to explore the differences between employed Albanian consumers when game mechanics are considered in a gamified purchasing setting. Furthermore, this study contribution is threefold. Initially, it provides information regarding game mechanics appliance in s-commerce consumer behavior as purchasing motivator. It also demonstrates the high importance of game mechanics successful design. Lastly, by empirically examining the employed consumers' differences for game mechanics elements, it provides significant contribution to science by extending the literature. Therefore, the current research creates a value-added on game mechanics, gamification and consumer behavior literature.

The findings of this research are beneficial for s-commerce retail business, mostly with the main purpose to attract and motivate consumers for purchasing behavior. The results are considerably useful to s-commerce retail trying to sell their products/services via s-commerce platforms. Also, for businesses who provide specified and/or general products/services for targeted employed consumers.

Similar to other research, the current study has its limitations. Although the results may be generalizing for countries that share same values, economic status as Albania, the study is limited to one country. The study sample is biased due to the fact that it provides information only for consumers who purchase via s-commerce, it would be interesting to compare the results for consumers who purchase offline and via m-commerce. Moreover, a comparison with unemployed consumers create an added value for retail businesses. Considering gamification as a broad concept additional game element may be investigated and provide important evidence for practitioners and researchers. Also, additional study can be conducted by adding extra variables such as education, gender and incomes.

### **Acknowledgement**

The authors are thankful for the financial support provided by the Internal Grant Agency of Tomas Bata University in Zlín, No. IGA/FaME/2018/005.

## References

- Baethge, C., Klier, J., & Klier, M. (2016). Social commerce: state-of-the-art and future research directions. *Electronic Markets*, 26(3), 269-290. doi: 10.1007/s12525-016-0225-2
- Berg, R. G. van den. (2018). Chi-Square Independence Test. Retrieved from <https://www.spss-tutorials.com/chi-square-independence-test/#what-is-it>
- Calderón, A., Boubeta-Puig, J., & Ruiz, M. (2018). MEdit4CEP-Gam: A model-driven approach for user-friendly gamification design, monitoring and code generation in CEP-based systems. *Information and Software Technology*, 95, 238-264. doi: 10.1016/J.INFSOF.2017.11.009
- Chang, J. W., & Wei, H.-Y. (2016). Exploring Engaging Gamification Mechanics in Massive Online Open Courses. *Educational Technology & Society*, 19(2), 177-203. Retrieved from <https://www.jstor.org/stable/jeductechsoci.19.2.177>
- Cheung, C. M. K., Shen, X.-L., Lee, Z. W. Y., & Chan, T. K. H. (2015). Promoting sales of online games through customer engagement. *Electronic Commerce Research and Applications*, 14(4), 241-250. doi: 10.1016/j.elerap.2015.03.001
- Decker, R., & Trusov, M. (2010). Estimating aggregate consumer preferences from online product reviews. *International Journal of Research in Marketing*, 27(4), 293-307. doi: 10.1016/J.IJRESMAR.2010.09.001
- Gatautis, R., Vitkauskaitė, E., Gadeikiene, A., & Piligrimiene, Z. (2016). Gamification as a Mean of Driving Online Consumer Behaviour: SOR Model Perspective. *Engineering Economics*, 27(1), 90-97. doi: 10.5755/j01.ee.27.1.13198
- Hamari, J. (2017). Do badges increase user activity? A field experiment on the effects of gamification. *Computers in Human Behavior*, 71, 469-478. doi: 10.1016/j.chb.2015.03.036
- Hamari, J., Alha, K., Järvelä, S., Kivikangas, J. M., Koivisto, J., & Paavilainen, J. (2017). Why do players buy in-game content? An empirical study on concrete purchase motivations. *Computers in Human Behavior*, 68, 538-546. doi: 10.1016/j.chb.2016.11.045
- Hamari, J., & Koivisto, J. (2014). Measuring flow in gamification: Dispositional Flow Scale-2. *Computers in Human Behavior*, 40, 133-143. doi: 10.1016/J.CHB.2014.07.048
- Hamari, J., & Tuunanen, J. (2014). Player Types: A Meta-synthesis. *Transactions of the Digital Games Research Association*, 1(2), 29-53. doi: 10.26503/todigra.v1i2.13
- Hammedi, W., Leclercq, T., & Van Riel, A. C. R. (2017). The use of gamification mechanics to increase employee and user engagement in participative healthcare services. *Journal of Service Management*, 28(4), 640-661. doi: 10.1108/JOSM-04-2016-0116
- Haziri, F., Chovancová, M., & Fetahu, F. (2019). Game mechanics and aesthetics differences for tangible and intangible goods provided via social media. *Management and Marketing - Challenges for the Knowledge Society*, 14(2), 176-187. doi: 10.2478/mmcks-2019-0012
- Haziri, F., & Chovancova, M. (2018). Game mechanics differences for Kosovars social media purchasers. Paper presented at 36th International Scientific Conference on Economic and Social Development - "Building Resilient Society", Zagreb, Croatia. Zagreb: Varazdin Development and Entrepreneurship Agency. Retrieved from <https://search.proquest.com/openview/ee797ad5b0b0c5e4475761796c9508a1/1?pq-origsite=gscholar&cbl=2033472>

- Hsu, C.-L., & Chen, M.-C. (2018). How gamification marketing activities motivate desirable consumer behaviors: Focusing on the role of brand love. *Computers in Human Behavior*, 88, 121-133. doi: 10.1016/J.CHB.2018.06.037
- Institute of Statistics - Instat. (2019). *Employment by administrative source and agricultural sector*. Retrieved from <http://www.instat.gov.al/en/themes/labour-market-and-education/administrative-data-on-labour-market/#tab1>
- Internet World Stats (2018). World Internet Users Statistics. Retrieved from <https://www.internetworldstats.com/stats.htm>
- Kim, J. T., & Lee, W.-H. (2015). Dynamical model for gamification of learning (DMGL). *Multimedia Tools and Applications*, 74(19), 8483-8493. doi: 10.1007/s11042-013-1612-8
- Kim, S., & Park, H. (2013). Effects of various characteristics of social commerce (s-commerce) on consumers' trust and trust performance. *International Journal of Information Management*. doi: 10.1016/j.ijinfomgt.2012.11.006
- Landers, R. N., Bauer, K. N., & Callan, R. C. (2017). Gamification of task performance with leaderboards: A goal setting experiment. *Computers in Human Behavior*, 71, 508-515. doi: 10.1016/j.chb.2015.08.008
- Lieberoth, A. (2015). Shallow Gamification: Testing Psychological Effects of Framing an Activity as a Game. *Games and Culture*, 10(3), 229-248. doi: 10.1177/1555412014559978
- Martin Poole, S., Kemp, E., Patterson, L., & Williams, K. (2014). Get your head in the game: using gamification in business education to connect with generation Y. *Journal for Excellence in Business Education*, 3(2). Retrieved from <http://www.jebejournal.org/index.php/jebe/article/view/40>
- McGuire, A., Broin, D. O., White, P. J., & Deevy, C. (2018). The effect of game elements in a career awareness system. Paper presented at European Conference on Games Based Learning, Reading, UK. Reading: Academic Conferences International. Retrieved from <https://search.proquest.com/openview/d752a033dcee385b5b73fb54970c060a/1?pq-origsite=gscholar&cbl=396495>
- Mekler, E. D., Brühlmann, F., Tuch, A. N., & Opwis, K. (2017). Towards understanding the effects of individual gamification elements on intrinsic motivation and performance. *Computers in Human Behavior*, 71, 525-534. doi: 10.1016/j.chb.2015.08.048
- Nour, M. M., Rouf, A. S., & Allman-Farinelli, M. (2018). Exploring young adult perspectives on the use of gamification and social media in a smartphone platform for improving vegetable intake. *Appetite*, 120, 547-556. doi: 10.1016/j.appet.2017.10.016
- Olbrich, R., & Holsing, C. (2011). Social Commerce. *WiSt - Wirtschaftswissenschaftliches Studium*. doi: 10.15358/0340-1650-2011-6-314
- Rahman, M. N. A., Jaafar, J., Kadir, M. F. A., Shamsuddin, S. N., & Saany, S. I. A. (2018). Cloud Based Gamification Model Canvas for School Information Management. *International Journal of Engineering & Technology*, 7(2.14), 28-31. doi: 10.14419/ijet.v7i2.14.11148
- Scheiner, C. W. (2015). The Motivational Fabric of Gamified Idea Competitions: The Evaluation of Game Mechanics from a Longitudinal Perspective. *Creativity and Innovation Management*, 24(2), 341-352. doi: 10.1111/caim.12115

- Shin, D. H. (2013). User experience in social commerce: In friends we trust. *Behaviour and Information Technology*, 32(1), 52-67. doi: 10.1080/0144929X.2012.692167
- Tabachnick, B. G., & Fidell, L. S. (2014). *Using multivariate statistics*. Harlow: Pearson.
- Werbach, K., & Hunter, D. (2012). *For the win: how game thinking can revolutionize your business*. Wharton: Wharton Digital Press.

### **Contact information**

#### **Fortesa Haziri**

Tomas Bata University in Zlín, Faculty of Management and Economics  
Mostní 5139, 76001, Zlín, Czech Republic  
E-mail: haziri@utb.cz, fortesa.haziri@gmail.com  
ORCID: 0000-0002-0804-3801

#### **Fortune Nwaiwu**

Tomas Bata University in Zlín, Faculty of Management and Economics  
Mostní 5139, 76001, Zlín, Czech Republic  
E-mail: nwaiwu@utb.cz  
ORCID: 0000-0001-8900-2130

#### **doc. Ing. Miloslava Chovancová, CSc.**

Tomas Bata University in Zlín, Faculty of Management and Economics  
Mostní 5139, 76001, Zlín, Czech Republic  
E-mail: chovancova@utb.cz  
ORCID: 0000-0002-9244-9563

doi: 10.7441/dokbat.2019.032

# IMPORTANCE OF INTERNAL CONTROLLING IN FRAUD DETECTION IN CZECH ENTITIES

*Jana Helová*

## **Abstract**

The aim of the paper is to present answers on questions of means used to prevent fraud commitment and early detection in organizations by using internal controlling department. Fraud is a serious problem everywhere in the world, which means huge financial losses not only for the company itself. Entities usually consider the risk of fraud inside as insignificant and therefore they do not take any preventive measures to minimize the possibility of its commitment. Companies lack the tools for quick detection of frauds and offenders. Here is the field of controlling, which deals with the basic issues related to the frauds in enterprises, their detection and prevention. Author performed research in 2018, when 51 employees of the controlling departments of companies operating in the Czech Republic participated in the questionnaire survey. Data were statistically evaluated using proportional and independence tests. For the purposes of the analysis, we have set the following research question: “*How much is the function of the internal controlling officer in detecting fraud important in Czech companies?*” We examined this research question from different perspectives and results showed that controlling staff plays important role within organizations for better fraud and mistake detection caused by accounting staff. Based on results some of fraud or mistakes detected had significant influence on company’s profit performance.

*Keywords: Internal controlling, fraud, fraud detection, accounting*

## **1 INTRODUCTION**

The control concept is coming from the English verb to control, which means to check but also to control or lead. This concept applied by foreign and Czech entities became as an all-encompassing term applied to all areas. Nowadays, a modern enterprise can successfully compete only if it puts efficient controlling processes into practice. Controlling is a complex interconnection (integration) of information, planning, implementation, management and control system. The goal of controlling is to recognize and solve problems or suggest measures for solving them in order to avoid such problems in the future. The sense of controlling may vary depending on the form of business entity, its size and on the extent of the funds, which management is willing to provide. The most important purpose is to ensure the functionality of the enterprise, from the perspective of examining the state of accounting and physical, as well as reviewing the financial affairs of the company. An essential part of controlling is its relationship to accounting and mainly to financial audit whose relationships work in reverse as well. Internal controlling, as already covered in naming of this discipline, has the main message to check and observe results of work done by accountants in the entity and to provide results, completeness and evidence of their work. Members of internal controlling departments in organizations should be the first who can discover any clues of fraud behaviour in enterprises.

The ultimate principle of bookkeeping is its true and fair picture, to maintain this rule, it is necessary to respect the honesty and reality of all data presented by companies. The accounting and current financial position of an enterprise is an integral part of the financial reporting of each company, so it is essential that the figures reported are consistent with the actual financial reality and not artificially created. However, if there is any modification or manipulation of the



data, we can speak of a certain amount of creativity in accounting or even fraud committed by employees of given organization. It is important to realize that fraud is on the increase and this is causing increasing damage to organizations. In some cases, their impact on the organization is also fatal.

The risk of fraud affecting virtually all economic operators is very common, but often underestimated. Committing fraud is a serious problem all over the world, as it often involves huge financial losses. Despite numerous studies, it is impossible to determine the exact extent of fraud losses. However, conducting crime studies is extremely important, as determining, the approximate size of a problem can make management aware of the estimated level of fraud loss and therefore decides to take action to effectively detect and suppress it. The fraud can negatively affect the business, causing huge losses of various types, such as reputational damage and reduced employee morale. All employees, regardless of their status or seniority, as well as people outside the company, can deceive organization. Therefore, it is extremely important for organizations to implement various anti-fraud measures and prevention measures, including awareness, detection, prevention and detection actions, as well as fraud risk assessment processes in the business. An Internal Audit or Controlling Department plays an important role in soon fraud detection. Effective internal audit or financial controlling can be very useful not only in founding fraud, but especially in the early detection and prevention of it. In order for these departments to work effectively, they need to have relevant knowledge of fraud, investigation techniques and relevant legal provisions.

That is why there is certain importance of controlling department within organizations. In academic literature and in business practice it is an increasingly present meaning. In the Czech business environment, it is a relatively new yet popular notion, which is nowadays getting wider. As business entities are open spaces for innovations and new terminology, controlling found its position very quickly in many types of worldwide companies. Controlling is spread through organizational structures does not matter how big the entity is, how many owners it has, or whether the enterprise is sourced by foreign capital. The controlling officer generally needs only basic accounting information as how to track costs, set prices, make future forecasts and check all financial outputs from accountants and management.

## **2 LITERATURE BACKGROUND**

Perhaps accounting is most critical and important social function is situating public corporations. Books of account represent substantially what corporate businesses remember about how their pasts became their presents, i.e., accounting data correspond to prior events bringing them to their present condition. They do this partly for their own purposes (managerial accounting), to depose to tax authorities, regulators, various capital providers, and the citizens with whom they share certain rights. These corporations are now the most dominant and powerful institutions in most peoples' lives. A corporation has no conscience or memory besides the one's society gives it. Accounting serves a critical role in providing, that which situates the corporate entity because it is a primary means of regulating corporate behaviour. (Forejt, Habarta & Trešlová, 2012)

This flexibility in accounting opens the door for many different methods of creative accounting. The boundary between creative accounting and fraud is very often unclear. The basic accounting equation is assets and expenses equal revenues plus liabilities plus capital. Therefore, it is possible to maintain the symmetry within accounting but classify expenses as assets and loans to revenues. There are five main strategies for the creative accountant. Strategy 1 involves increasing profit by increasing revenues, for example by treating loans as sales, by the premature recognition of sales, by maximizing other revenues or by treating loans as sales.

Strategy 2 involves increasing profit, this time by decreasing expenses by methods such as provision accounting, increasing inventory, and capitalizing expenses, lengthening asset lives, minimizing bad debts, minimizing tax or using the big bath technique. Strategy 3 focuses on increasing the net worth of the balance sheet by increasing the assets, for example, by including brands and intangibles, goodwill and revaluating fixed assets. Strategy 4 also involves boosting the net worth of the balance sheet, however, this time by reducing liabilities through, for example, off-balance sheet financing or reclassifying debt as equity. Finally, strategy 5 involves maximizing operating cash flow. Maximizing of operating cash flow can be by two ways. The first involves maximizing operating cash flows. The second, minimizing operating cash outflows. (Fenyk et al. 2010)

Management accountants need high-quality data in order to become the ones who know and the ones who tell the truth. They therefore expand the scope of their tasks to cover methods and pure bookkeeping, for instance, in order to ensure data quality, which in this case relates to the reliability of the product schedule. (Lambert & Pezet, 2011)

All accountants' technical expertise is linked the status and credibility attributed to the accounting profession not only to accountants' technical expertise but also to their ability to project a public image of themselves as 'ethical experts'. In other words, the function that accountants fulfil in the economic system is dependent on the profession's ability to maintain the perception of high ethical standards and ensure for themselves a respectable image within the community at large. Therefore, to fulfil their function, it is necessary not only let accountants act ethically but also that the public perceives them to do so. (Caglio & Cameran, 2017)

As already mentioned, controlling is in the Czech business environment a relatively new yet popular word. Controlling consists of verifying whether everything occurs in conformities with the plans adopted, instructions issued and principles established. Controlling ensures that there is effective and efficient utilization of organizational resources to achieve the planned goals. Controlling measures, the deviation of actual performance from the standard performance, discovers the causes of such deviations and helps in taking corrective actions. (Daft, 2012)

Controlling has multiple meanings, as effecting, keeping in check or simply giving orientation. Controlling is not only about monitoring given plans. Thanks to the plans (raw material procurement, investment, repairs, production, sales, human resources, etc.) and accounting information from the company, it is easy to compose budgets and calculations for the analysis of the financial performance of the business and evaluate whether the entity is approaching its profit goals. Generally, for the term controlling exists no consistent definition in the scholarly literature. (Eschenbach, 2004)

There are existing two main trends:

- a) Strategic controlling, which is oriented to the future. The main goals here play management of long-term profit potential focused on strategic business philosophy, analysing strengths and weaknesses of the company and mainly formulating strategic goals;
- b) Operational controlling captures shorter periods, constantly compares the deviations from reality, flexibly interfered with the course of business operations, and thus optimized the activity. This trend checks, evaluates and determines the processes of leading to the stated strategic objectives. It establishes a quality reporting, which on one hand is used for basic data processing and presentation, on the other hand, participates in the creation of an appropriate information base and adequate management and control mechanisms.

## **2.1 Development of controlling**

Development of controlling system was more than 100 years in American business practice. Experts designated controlling originally for a specific type of planning, covering controls in accounting, finance, and subsequently expanded to other business activities. It was only later begin to use in Europe, the most in the '50s in Germany. As a critical year for controlling is mentioned year 1880, which is associated with introduction of the position of controller in American society Acheson, Topeka & Santa Fe Railway System. The second milestone in the controlling history is year 1892, which is associated with the American industrial company General Electric Company, which as first in the industry set up a working position of controller. (Ciesielski & Weirich, 2015)

Controlling in Europe was firstly used after WWII and to Czech Republic came in the turn of the 20th and 21st century mainly due to the entry of multinational corporations into the Czech market. The introduction of controlling a larger scale was up with the economic crisis, which has increased the requirements for cost management and business planning.

Nowadays organizations establish controls in a number of different areas and at different levels. The responsibility for managing control is extensive. There are existing four basic areas, which definitely need controlling management to control over – physical, human, information and financial resources. Control on level of physical resources includes mainly inventory management, control of quality and equipment control. Human resources control as it is clear takes control over human resources in the company. This includes whole process of hiring of new employees, their selection and placement, training of all staff and their development, performance appraisal and compensation. Control on level of information resources includes sales-marketing forecasting, macro and microanalysis, public relations, all types of marketing, production scheduling and economic forecasting. The last type of control - financial resources control involves managing the organizations debt, cash flow and receivables/payables accounts. Control of financial resources may be the most important control of all and that is why we focused our patience to it in this paper.

## **2.2 Actual situation in the Czech Republic**

Organizations need controls in order to determine meeting their goals and to take corrective action where it is necessary. Control in the entity is the regulation of organizational activities so that some targeted elements of performance remain within acceptable limits. These limits are usually set before the environment change and before controlling tool is used. The purpose of the control is mainly to adapt to environmental change and as already mentioned – act quickly and precisely. A control system can to anticipate, monitor, and respond to changing environmental conditions.

Following are some of the most essential errors, where perfectly settled controlling department can limit the accumulation of errors or reduce them. An error is coping with organizational complexity, which is a factor increasing dramatically over recent times. The next one is minimizing of costs, control can help reduce costs and increase output. This definition then leads to increase of profit, because properly settled limits can lead to increase of organizational profit. These are also fields of each financial audit; proper controlling can suffer big mistakes from financial audit, moreover check actual settlement of controls and provide entity with more details to catch more costs and debts.

Actual situation in the Czech Republic differs based on concrete controlling organization. Very usually do a separate department, chief financial officer, external staff, assistant director of the company and many other positions perform the controlling position across entity. Factors that affect this are the size of a firm position on the market, the need for innovation, the complexity

issues and mainly the company strives to innovate and develop. Usually no diversification of controlling department from accounting department in Czech entities goes from long-term external auditors' practice.

Criminal activities and organized crime became the main generators of social and state instability in the recent years, much more than the wars. They generate significant illegal money and need to launder this money, which tends to integration to the legitimate financial system. Economic and financial crimes that called white-collar crimes, typically has diffuse costs to society and concentrated benefits for the perpetrators. The social expectations are that the auditors should play an effective role in reducing, if not eliminating, these crimes. New auditing standards require auditors to take a proactive approach to assessing whether management has in place appropriate systems and controls to manage the risk of fraud. (Petrevska & Petrevska, 2014)

Firms can see the role for the accountant two-dimensional: involvement in the internal operations of the company, focusing upon performance and compliance concerns, and in the external dimension relating to the disclosure of economic information to external report users. We can define those users as resource providers, recipients of goods and services and parties performing a review or oversight function. (Vollmuth, 2004)

In Czech practices these two trends of controlling stays for planning and reporting respectively. Unfortunately, there is no existing modern literature covering how controlling in praxes in the Czech environment really works. Czech entities still have only limited use of what controlling could really bring.

### **2.3 Fraud and fraud characteristics**

The concept of fraud began to emerge during the 1980s. Even nowadays, there is not enough literature to fully cover or delimit this topic. Fraud is an act committed by anyone who misuses someone's ignorance, incapacity or credulity for their own unjust enrichment or benefit and misleads someone by their actions. According to literature sources (Drábková, 2017), defining fraud is a very complex problem. This term means misuse of accounting in order to better present the company in the financial statements. It is therefore possible to meet human creativity, knowledge and knowledge in the field of accounting theory and practice when preparing and presenting financial statements. In the Czech Republic, Section 209 of Act No. 40/2009, the Criminal Code, regulates this crime. There are not defined the boundaries between accounting creativity and accounting fraud in the processing of accounting data as well as between deliberate doing and oversight. We could simply say that we are talking about fraud every time the conduct is in contrast to the Criminal Code.

## **3 METHODOLOGY**

The aim of the article is to assess whether internal control departments are helping to detect fraud in companies and in what possible material impact. In 2018, author sent out questionnaires by emails to haphazardly 92 selected companies, which has based on portal justice.cz its business office in the Czech Republic. Author do not considerate type of business, ownership and size of the enterprise. Only 51 employees of the controlling departments of companies operating in the Czech Republic participated in the questionnaire survey. Response rate for given questionnaire is 55.4%. Data were statistically evaluated using proportional and independence tests. Where the independence test showed a statistically significant relationship between the variables, sign variance schemes used to interpret the results.

### 3.1 Research question

For the purposes of the analysis, we have set the following research question:

#### **How much is the function of the internal controlling officer in detecting fraud important in Czech companies?**

We examined this research question from the following perspectives and settled for them following hypotheses:

- 1) *Do the controlling staff rely on the results of the accounting department staff?*
- 2) *In the performance of their duties, did the Controlling Officer detect any errors or fraud committed by accountants in their documentation?*
- 3) *How significant were the errors or fraud mistakes detected in comparison to overall yearly revenues of the entity?*

## 4 RESULTS

*First question - Do the controlling staff rely on the results of the accounting department staff?*

Tab. 1 – Results of first question. Source: own research

Answer	Frequency	%
Never	42	41.2 %
Almost never	20	19.6 %
Occasional	9	8.8 %
Often	22	21.6 %
Still	9	8.8 %
Total	102	100.0 %

As shown in Table 1, almost thirty-nine percent of controlling officers somehow rely on results reported by accounting department staff, and over sixty percent do not. In other words, more than one-third of controlling staff, within their prior review, rely on documentation given to them by department staff with less or no control over it and about two-thirds of them use own scepticism.

*Second question - In the performance of their duties, did the Controlling Officer detect any errors or fraud committed by accountants in their documentation?*

Tab. 2 – Results of second question. Source: own research

Answer	Frequency	%
Not at all	30	29.4 %
Sporadically	53	52.0 %
Often	16	15.7 %
Constant	3	2.9 %
Total	102	100.0 %

Table two shows that almost eighty-one percent of controlling officers detected no or very sporadically fraud or mistakes in accountants' documentation. Twenty-nine percent of controlling staff officers have no experience with detecting errors or fraud commitment. Fifty two percent of controlling officers' work with errors and fraud committed by accountants sporadically, and only sixteen percent work with them frequently. A surprising finding is that only three percent of requested controlling officers are constantly detecting errors or frauds committed by accountants.

*Third question - How significant were the errors or fraud mistakes detected in comparison to overall yearly revenues of the entity.*

Tab. 3 – Results of third question. Source: own research

Answer	Frequency	%
No errors	30	29.4 %
Less than 0,5%	32	31.4 %
In range 0,5-5%	18	17.6 %
In range 5-10%	20	19.6 %
Over 10%	2	2.0 %
Total	102	100.0 %

Results of table 3 support results of second question that over twenty-nine percent of controlling officers did not find errors at all. Next results show that over thirty-one percent of controlling officers work with errors or mistakes coming from fraud commitment recalculated in amount less than 0.5% or overall yearly revenues. Over thirty-seven percent of found errors or fraud mistakes is in range of 0.5-10% of overall yearly revenues of the entity. Almost two percent of errors or fraud mistakes detected by controlling officers reached over ten percent of overall yearly revenues of the entity.

#### 4.1 Statistical hypotheses

Statistical hypothesis HA1: *Most controlling officers are never relying or almost never relying on submitted results by accountants.* Stated hypothesis means in other words that controlling officers are checking documentation given to them by accountants and are never or almost never relying on data which accountants give them as being the right one. A one-sample proportional test at a significance level of 5% showed that most controlling officers are never relying or almost never relying on submitted results by accountants. ( $Z = 4.353$ ,  $p\text{-value} < 0.001$ ).

HA2: statistical hypothesis: *Controlling officers, in the performance of their duties, are detecting mistakes or fraud in documentation performed by accounting staff.* Hypothesis is trying to reflect the fact, that mistakes and fraud is in documentation submitted by accountants as to being ready and properly done and controlling officers find them.

The results of the two-sample proportional test indicate that controlling officers, in the performance of their duties, are detecting fraud in documentation performed by accounting staff. ( $Z = -0.944$ ,  $p\text{-value} = 0.827$ ). Therefore, controlling officers plays important roles in fraud detection for entities with this position.

## 5 CONCLUSION

In many companies where they believe that they have a modern management system, are often confused with the process of the internal audit and the process of controlling. It is a basic misunderstanding of the functions of these activities. Controlling is part of the planning and management participates in the strategic philosophy of the business and formulation of basic strategic aims. Controlling in the firm behaves as a corporate filter, which should eliminate unnecessary costs and any mistakes and losses.

There are existing typical factors influencing the choice of appropriate organizational controlling, as is size of an enterprise, for example large enterprise means separate departments or controlling unit with many departments. The position of the enterprise on the market is very important. The pursuit of victory increases the importance of controlling in the organization. The complexity of the problem also plays its role - the bigger and more complex problems, the greater the importance of controlling within the entity is. Its role plays the need for innovation with a lot changes and challenges growing importance of organization controlling. Another factor is the state of information technology in the enterprise and the tradition of controlling in the firm. Controlling in entity definitely helps to save costs, better organizes internal processes,

show hidden mistakes and frauds and finally helps financial auditors during their audit proceedings.

Gained results showed that more than one-third of controlling staff, within their prior review, rely on documentation given to them by department staff with less or no control over it and about two-thirds of them use own scepticism. This means that controlling staff needs to take action and check documentation provided by accountant staff to avoid mistakes and errors in final financial statements. A surprising finding about importance of controlling department is that only three percent of requested controlling officers are constantly detecting errors or frauds committed by accountants. What is more, almost two percent of errors or fraud mistakes detected by controlling officers reached over ten percent of overall yearly revenues of the entity. The proportional test indicates that controlling officers, in the performance of their duties, are detecting fraud in documentation performed by accounting staff.

Results supported an idea that for entities without controlling department there is bigger chance for not detecting possible fraud or mistakes coming from accounting background. Such mistakes or fraud behaviour can lead to often-significant negative impacts for entities in means of financial loss or damage of good name of the entity. Importance of controlling department within entities is in its role as filter for next spreading and issuing of incorrect and fraudulent statements. This investment will certainly pay off in the end.

According to results of given research it is hard to say with certainty that it was mistakes coming from overlooking or fraud what committed differences in reported documents presented by accounting staff. Even fraud commitment can be firstly coming from few small not discovered mistakes resulting in fraudulent issues. First not discovered mistake can persuade accountant to try more hidden surprises inside presented documentation. Controlling department is definitely essential tool for entities, especially where the external audit is not mandatory. Results showed that controlling is definitely important for sooner fraud detection. Rather let the controller reveal a small mistake or fraud commitment now, rather than lay down the whole business later.

## References

- Abreu, R. (2015). Accounting for Citizenship: The Role of Accountant. *Procedia Economics and Finance*, 26(1), 933-941. doi: 10.1016/S2212-5671(15)00909-0
- Bowron, M., & Shaw, O. (2007). Fighting Financial Crime: A UK Perspective. *Economic Affairs*, 27(1), 6-9. doi: 10.1111/j.1468-0270.2007.00701.x
- Caglio, A., & Cameran, M.. (2017). Is it Shameful to be an Accountant? GenMe Perception(s) of Accountants' Ethics. *Abacus*, 53(1), 1-27. doi: 10.1111/abac.12098
- Ciesielski, J. T., & Weirich, T. R. (2015). Current Accounting Issues Facing Chief Accounting and Chief Financial Officers. *The Journal of Corporate Accounting & Finance*, 26, 63-72. doi: 10.1002/jcaf.22065.
- Daft, R. (2012). *Management*. Australia: Cengage Learning.
- Dvořáček, J. (2014). *Due diligence: podstata, postupy, použití*. Praha: Wolters Kluwer.
- Drábková, Z. (2017). *Kreativní účetnictví a účetní podvody: řízení rizika účetních chyb a podvodů*. Praha: Wolters Kluwer.
- Dufils, P. (2004). *Finanční audit*. Praha: HZ.
- Eschenbach, R. (2004). *Controlling*. Praha: ASPI.

- Fenyk, J., Hájek, R., Polák, P., & Stríž, I. (2010). *Trestní zákoník a trestní řád, průvodce trestněprávními předpisy a judikaturou*. Praha: Linde.
- Flanagan, J. & Clarke, K. (2007). Beyond a Code of Professional Ethics: A Holistic Model of Ethical Decision-Making for Accountants. *Abacus*, 43(4), 488-518. doi: 10.1111/j.1467-6281.2007.00242.x
- Forejt, P., Habarta, P., & Trešlová, L. (2012). *Zákon o trestní odpovědnosti právnických osob a řízení proti nim s komentářem*. Praha: Linde.
- Grosanu, A., Rachisan, P. R., Berinde, S. R., & Bonaci, C. G. (2011). The conciliation between the results of managerial accounting and the results of financial accounting. *International Journal of Education and Information Technologies*, 5(2), 225-233. Retrieved from <http://naun.org/cms.action?id=3037>
- Jelínek, J. (2010). *Trestní právo hmotné*. Praha: Leges.
- Jones, M. J. (2011). *Creative Accounting, Fraud and International Accounting Scandals*. New York: Wiley.
- Kislingerová, E. (2010). *Manažerské finance*. Praha: C. H. Beck.
- Kuchta, J. (2009). *Kurs trestního práva, Trestní právo hmotné. Obecná část*. Praha: C. H. Beck.
- Kuchta, J. (2009). *Kurs trestního práva, Trestní právo hmotné, Zvláštní část*. Praha: C. H. Beck.
- Lambert, C., & Pezet, E. (2011). Making of the management accountant – Becoming the producer of truthful knowledge. *Accounting, Organizations and Society*, 36(1), 10-30. doi: 10.1016/j.aos.2010.07.005
- Molín, J. (2011). *Protiprávní jednání z pohledu profesní odpovědnosti auditorů, daňových poradců a účetních*. Praha: Wolters Kluwer.
- Petrevska, I., & Petrevska, M. (2014). The Role of Accountants and Auditors in Fighting Organised Crime. *Journal of Process Management - New Technologies*, 2(3), 24-29. Retrieved from <http://scindeks.ceon.rs/article.aspx?artid=2334-735X1403024P>
- Růžičková, P. (2011). *Finanční analýza - 4. rozšířené vydání: metody, ukazatele, využití v praxi*. Praha: Grada.
- Solnař, V. (2009). *Systém českého trestního práva*. Praha: Novatrix.
- Songlan, P., & Bewley, K., (2010). Adaptability to fair value accounting in an emerging economy. *Accounting, Auditing & Accountability Journal*, 23(8), 982-1011. doi: 10.1108/09513571011092529
- Šámal, P. (2009). *Trestní zákoník I, komentář*. Praha: C. H. Beck.
- Šámal, P. (2012). *Trestní odpovědnost právnických osob: komentář*. Praha: C. H. Beck.
- Tolk, A. (2017). Code of Ethics. In A. Tolk & T. Oren (Eds.), *The Profession of Modeling and Simulation: Discipline, Ethics, Education, Vocation, Societies, and Economics*. New York: Wiley. doi: 10.1002/9781119288091.ch3
- Trotman, K. T., Tan, H. C., & Ang, N. (2011). Fifty-year overview of judgment and decision-making research in accounting. *Accounting & Finance*, 51(1), 278-360. doi: 10.1111/j.1467-629X.2010.00398.x
- Venter, E. R., Gordon, E. A., & Street, D. L. (2018). The role of accounting and the accountancy profession in economic development: A research agenda. *Journal of International Financial Management & Accounting*, 29(2), 195-218. doi: 10.1111/jifm.12080



- Vollmuth, H. (2004). *Nástroje controllingu od A do Z*. Praha: Profess Consulting.
- Vysušil, J. (2004). *Rozpočetnictví a vnitropodnikové plánování: sladění plánu a skutečnosti pro potřeby controllingu*. Praha: Profess Consulting.
- Yang, Z., Rohrbach, K., & Chen, S. (2005). The Impact of Standard Setting on Relevance and Reliability of Accounting Information: Lower of Cost or Market Accounting Reforms in China. *Journal of International Financial Management & Accounting*, 16(3), 194-228. doi: 10.1111/j.1467-646X.2005.00117.x

### **Contact information**

#### **Ing. Mgr. Jana Helová**

Tomas Bata University in Zlín, Faculty of Management and Economics  
Mostní 5139, 76001, Zlín, Czech Republic  
E-mail: helova@fame.utb.cz  
ORCID: 0000-0003-3780-2907

doi: 10.7441/dokbat.2019.033

# REFORM OF PENSION SYSTEM AS A WAY FOR SOCIAL STABILITY

*Raman Herasimau*

## **Abstract**

This paper provides an examination of changes and reforms of pension system, its impact to social system and stability. Focusing on development of pension system, it discusses why pension reforms and changes were done, how they are impacted social stability. The analysis shows that changes should be done due to new challenges in savings behaviour, migration, fertility rate, and education. The uncontrollable migration policy in EU leads to decreasing in the quality of working force and doesn't help increase fertility rate, education, as a main element of saving behaviour, is not enough for active investment decisions, some states prefer voluntary elements during implementation of pension system which leads to rejection whole reform.

*Keywords: pension system, Slovakia, Czechia, Poland, social stability, pension reforms*

## **1 INTRODUCTION**

Social stability one of the main elements of the political and economic stability of the country. Policymaker, economists, scientists should find out such compromise which will be from one side satisfy budget constraints and from the other side doesn't "rock" society.

The first pension systems were created for stabilization social system and including general population in financing public expenditures. Today there are all countries have mixed pension system and almost whole population participates in social as well as pension system. At the same time, modern problems are different from past, they take roots from population aging, decrease in fertility rate, financial crisis etc.

State can influence to pension system or through reforms or through parametric changes such as age, seniority (years of work). For example, Sudén (2004) said that it is a trend to introduce individual accounts as part of both public and occupational schemes. One of the biggest parts of public expenditure are pensions: more than 10% of GDP on average today, possibly rising to 12.5% in 2060 in the EU as a whole. Spending on public pensions ranging from 6% of GDP in Ireland to 15% in Italy today, countries are in rather different situations although they face similar demographic challenges.

The country-specific pensions focus strongly on the need to keep older workers longer on the labour market, notably by raising the pensionable age and linking it to gains in life expectancy. In the first instance, increasing effective retirement ages would compensate to some extent for the earlier longevity growth, which has not been factored into pension calculations. Linking the pensionable age to life expectancy could then help stabilize the balance between working years and years in retirement. This is of key importance for future sustainability of social system. Simulations in the European Commission's 2009 Sustainability Report suggest that increasing the retirement age in line with future gains in life expectancy could result in budgetary savings representing more than half of the projected increase in pension expenditure over the next 50 years (European Commission, 2012).

In this article, we won't argue which system is better but look how much reforms affect the whole social system. What is the impact of pension system's reforms and changes on social stability?

## **2 METHODS AND METHODOLOGY**

For the purpose of the article author used historical method to show changes in countries' pension systems, graphical method for better view of results from reforms, analysis, analogy and comparison methods for understanding if countries have achieved aims in compare with neighbours.

Methodology of the work based mainly on the foreign and domestic (Czech and Slovak) literature and researches in this field (books, reports, articles, white papers etc.), also were used, reports of international organizations. Author used peer-reviewed evaluation as a scientific method in the study of the issue of the changes in the pension systems in the future. Author used the researches of economists that work at the topic.

Analyse of literature and historical steps of pension systems develop help us understand why countries have different reforms. Comparison method help us found similarities and differences in opinion of economists. For the conclusion, we used synthesis, which mean that we'd combined received results and created common view for development of pension systems.

Selection of literature was done based on the most developed countries in socio way such as Sweden, Germany, Japan. Discussion of pension system's form in Sweden had been started in 1907 and was successfully implemented in 1913. German as a country which social model is using by most of EU countries and at the same time country which faced more than others with migration crisis. Japan related literature was chosen as an alternative to European individualism as well as this country has aging population problems. Researches from these countries correlates with data from Slovakia and Czechia.

## **3 LITERATURE REVIEW**

The challenge for pension policies is to put in place a system that is financially sustainable so that the basic purpose of pension systems, namely to deliver adequate retirement incomes, to allow older people to enjoy decent living standards and economic independence and to level gap into earnings, can be achieved

Annual Growth Surveys (AGS) 2011 and 2012, which was prepared by the European Commission, highlighted key orientations for pension reforms which contribute to growth-friendly fiscal consolidation and will ensure adequate and sustainable pensions. For balancing between working years and years in retirement and of promoting complementary retirement savings Commission recommended to:

- a) link the retirement age with increases in life expectancy;
- b) restrict access to early retirement schemes and other early exit pathways;
- c) support longer working lives by providing better access to life-long learning, adapting work places to a more diverse workforce, developing employment opportunities for older workers and supporting active and healthy ageing;
- d) equalize the pensionable age between men and women;
- e) support the development of complementary retirement savings to enhance retirement incomes.

Successfully implementing pension reforms along these lines will contribute to putting the pension systems on a more sustainable path and thereby help states to offer their citizens adequate incomes in old age even in a much less favorable demographic context.

Increasing retirement age does not put interests of the young against those of the old. Staying active during some of the extra life years gained does not mean that older people are being deprived of their well-deserved retirement for the benefit of the young. Neither does it mean that older workers will keep jobs that would otherwise be available to younger workers. It's about low level of unemployment rates as older workers as youth employee, it's about knowledge and experience continuity and also increasing of life level and quality.

In the long-term, the number of jobs is not fixed, but depends notably on the supply of qualified workers, which is a key driver of economic growth. The increased availability of experienced older workers will enhance Europe's growth potential and thus create more opportunities and better living conditions for the young and the old.

Sometimes reforms could be indirect from the point of view pension system, for example Cigno and Rosati (1997) analysed alternative models of household saving behaviour. They tested using Japanese post-war time series data. They rejected life-cycle theory and models based on some form of intergenerational altruism in favour of an extended life-cycle model based on the assumption of strategic self-interest. Also, they show that early rise and subsequent fall of the saving rate are not because of the interaction of state, capital market but extended family as providers of old-age social security too. As a result, early rise in saving rate connects with the number of newly savers into public pension system. At the same time, proportion of these new savers decided recourse the capital market than with the help of the family. The successive decline in the saving rate related to the reduction in the amount saved by existing savers. Their arguments rests on the idea that extended family system provides a third way - an alternative to social security and the capital market - of making life-cycle adjustments.

The effects of introducing PAYG in the intermediate case of a large open economy, which affects international interest rates, may be very different from those obtained in the polar cases of closed or small-open economies (Arrau & Schmidt-Hebbel, 1995). Breyer and Wildasin (1993) show that starting PAYG implies an additional term of trade gain (loss) when the economy is a net creditor (debtor) of the rest of the world, derived from an increase in international interest rates. In a multi-country setting with free migration, government debt and pension systems -- relevant for the European Union -- national PAYG schemes that are not harmonized across countries result in inefficient international allocation of resources (Homburg & Richter 1993).

When some people are more myopic (have higher discount rates) than others within their cohorts and also face credit constraints, introducing a mandatory Fully funded system forces them to save involuntarily.

Hedesstrom, Svedsater and Garling (2006) in their research found out how had changed behavior of savers after implemented PPS in Sweden. They noticed that people prefer choosing the default fund were 82.4% in 2001, 85.9% in 2002, and 91.6% in 2003. The increase in choices of the default fund in the following years may reflect that those entering the PPS at a later stage on average had a smaller amount to invest (contributions earned during one year) than those who entered the scheme in 2000 (some of whom invested contributions earned during four years). This is supported by research that having a larger amount to invest makes individuals less likely to choose the default fund. The typical choice among those who did not select the default fund was to include as many funds as were allowed (five) in the portfolio, all of which belonging to different fund categories. To include many funds in the portfolio should thus not necessarily be considered a bias, as it may reflect effective diversification. However, if selecting a large number of PPS funds is due to acting on an impulse to seek variety (evoked by the simultaneous choice frame, rather than due to a deliberate decision based on sufficient knowledge, effective diversification is unlikely. In order to reduce the investment's risk,

portfolio theory prescribes holding a stock portfolio that is diversified across countries and industries, since the returns of included assets ought not to be excessively correlated. Choosing many funds may thus lead PPS investors to believe that they reduce the investment’s risk more than they actually do. Research shows that people who don’t connect with investments, economy or at least public sector have less knowledge and make wrong investments decisions, as a result improving financial education of the population has led Sweden to adequate level of risk illumination.

Thanks to Cifuentes (1994) who used P. Arrau's dynamic simulation model to address an issue that inspires many pension reforms. The financial collapse of many PAYG systems due to growing benefits and rising dependency ratios, has led policy makers to propose higher retirement ages as a solution to growing pension system deficits. Chile, Germany. Italy and Japan have increased retirement ages to 65 years and the United States has raised it to 67 years. Cifuentes simulates an increase in retirement age and estimates the welfare effect for every cohort during the transition period and the new steady state. He finds that the welfare impact on those cohorts which are close to retirement age can be substantial, reaching between 10 and 15% of their welfare (wealth-equivalent) levels. This result points toward the need to be careful when raising retirement ages in order to minimized disproportionately high welfare costs paid by reform-transition cohorts.

Development of pension system and its reforms are not unique in its essence. The same problems today have Slovak and Czech Republic.

For our article we assumed that conservative fund is the same as default fund in Sweden, because usually these funds are riskless and in case of SR, they are guaranteed ones. From the Figure 1 we see that most people prefer choose default fund. From 1 564 638 participants 65% (1 013 230) have riskless savings. This is correlate with Sweden research that people without enough knowledge or experience choose default fund, in case of Slovakia this is guarantee fund. Other 40% of participants have almost equal parts into Index fund, Stock and Others (different combinations of market securities).

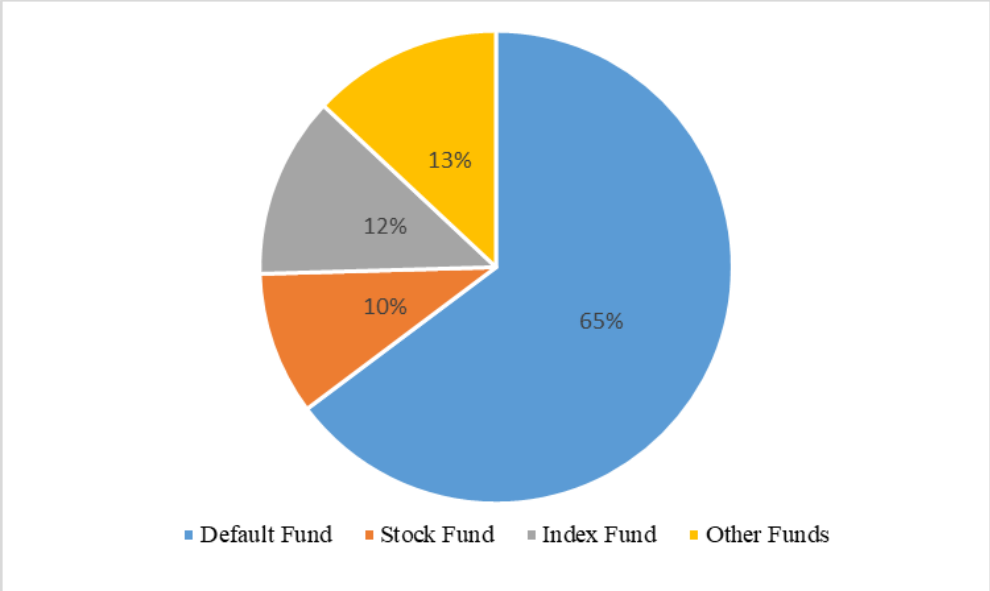

Fig. 1 – Participants allocation between funds in the 2<sup>nd</sup> pillar in SR. Source: ADSS (2019)

Figure 2 shows expected things that default fund has less risk and less profit, this scheme is relevant for soon retirements but not for new participants or people who have more than 10 years before the pension age.

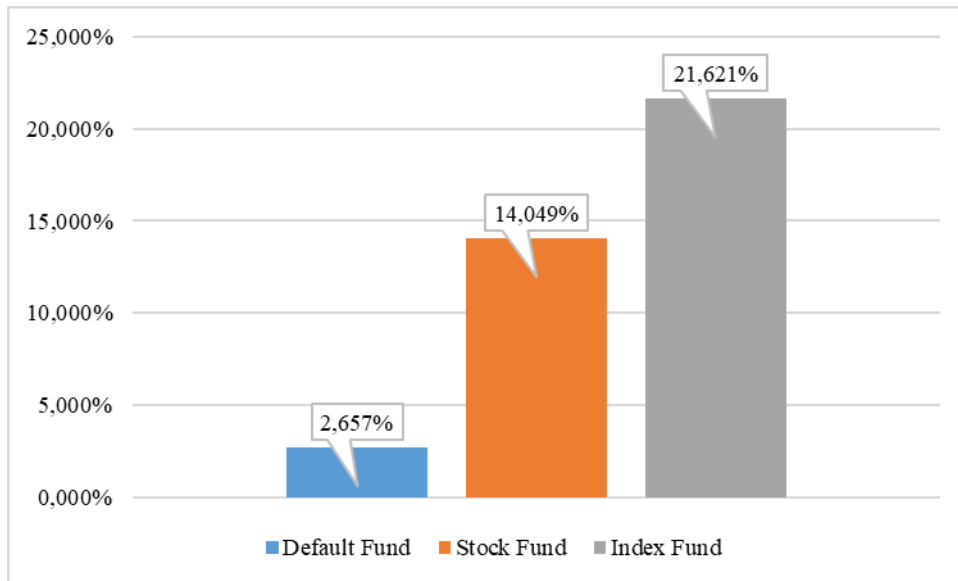

Fig. 2 – Funds' Profitability in SR. Source: ADSS (2019)

Pension system in Czech Republic is different but problems of active investment decisions are the same Figure 3.

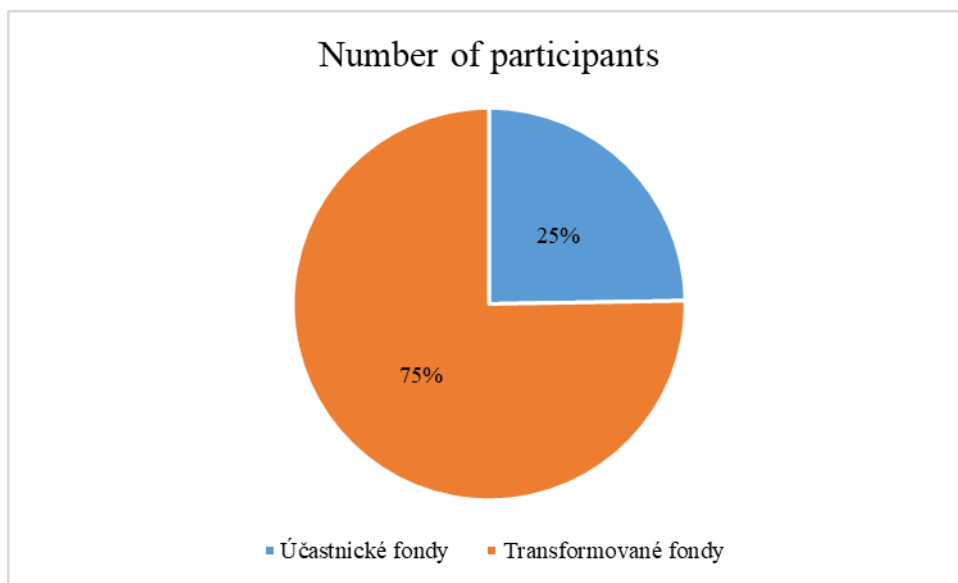

Fig. 3 – Participants allocation between funds in CZ. Source: APFCR (2019)

Transformation funds are less risky and have very conservative and careful strategy from 4 445 245 participants 75% (3 345 778) use default fund and only 25% prefer make active investments decisions. This numbers absolutely the same as in SR. It says that socio-economic situation in both countries is the same.

Simultaneously, Slovak republic has better profitability of both default fund and others Figure 4. In the 2019 participants lost their savings even conservative funds didn't provide inflation cover.

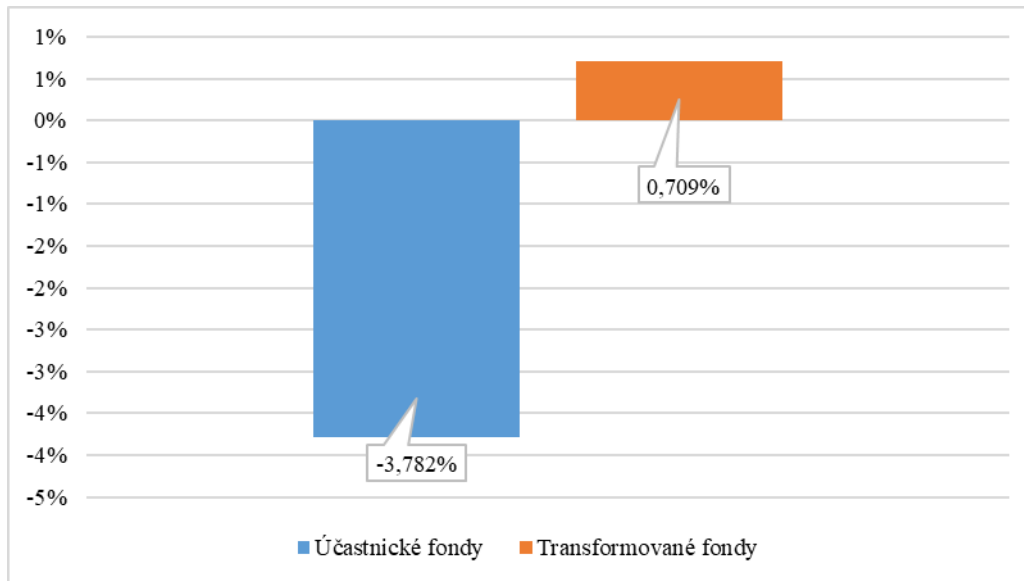

Fig. 4 – Funds' Profitability in CZ. Source: APFCR (2019)

Figure 5 shows movement of pension savings as percent of GDP. We can notice that Slovak republic has better results among three countries.

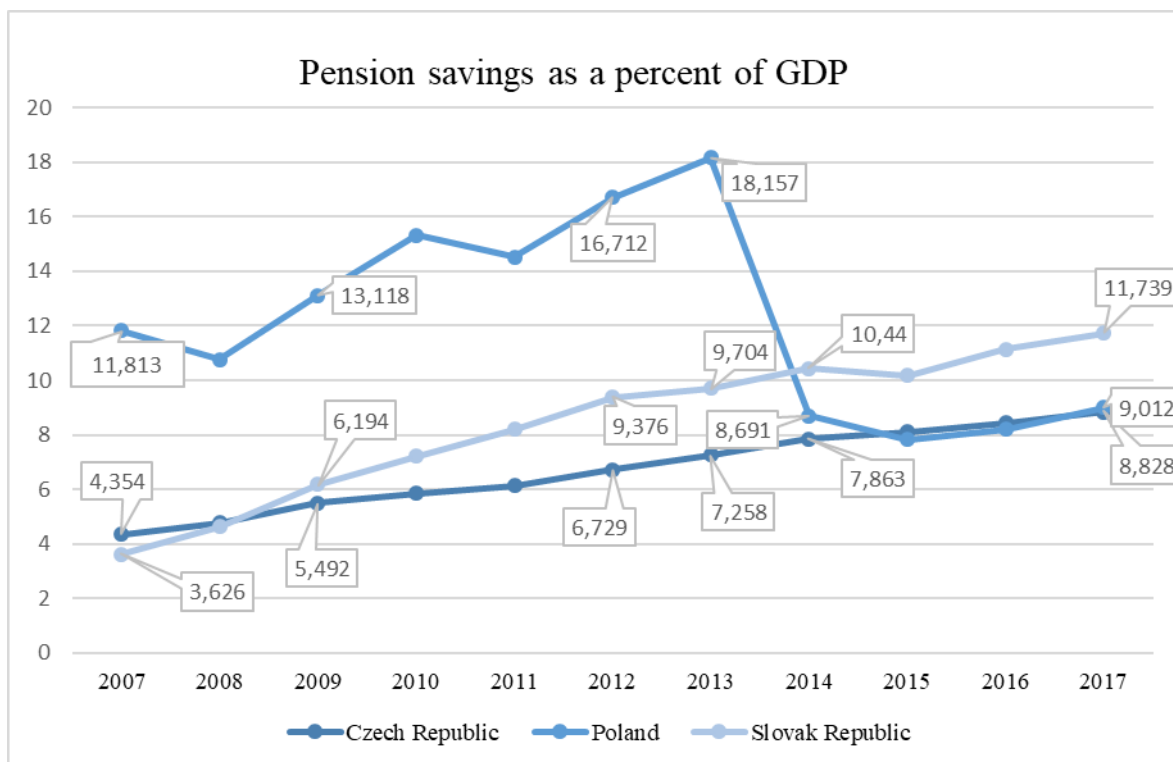

Fig. 5 – Pension savings movement. Source: OECD (2017)

The quickest growth had Poland, it started forming of it pension system in 1999. Even during the crisis 2008 it had great growth but in 2013 was strong fell to the Czech republic's level, from our point of view it relates with nationalization process of almost 51.5% of non-state pension fund assets. At the same time, Slovak republic show vest results, it also started reforms in 1998, and did it from implementation 2nd pillar as a mandatory which helped to attract savers. From the other hand, Czech Republic, reformed its system only in the way of deductions

to people who have retirement savings in the 3rd pillar, even implementation the 2nd one in the 2013 and it next declined in 2015 didn't influence to average level of savings.

## 4 CONCLUSION

As a result, we can mention that reforms in pension system have significant influence for stability of social system. Through pension system we can influence to people's economic and financial education, prevent "myopic" and reinforce responsibility. In today's falling of fertility pension system can help increase number of the children as a 3rd source of retirement investments. From the one side state can increase working age but at the same time if the parametric reforms would be done wrong it could decrease the level of life whole cohort. Involvement old workers positively influence to whole labour market, it provides budgetary savings, knowledge and experience continuity. During next 40 years we will have fertility falling with increasing of life expectancy to 77 years in 2045-2055, that will lead to labour force deficit, which will have impact to parameters of pension system in every country.

Transitions economies such as Slovak and Czech, have absolutely the same problems as had Scandinavian countries or West Europe. Not enough just implement pillar how it did Czech Republic, because will lead to rejection by society it, but need to do huge work in the way of explanation why it is good for every individual person. Both countries CZ and SR have the problem of passive investments, people don't want take responsibility for their future what will affect pensions in the future and as a result – negative relation to whole system.

Based on said above we can give suggestions:

- a) Ministry of Labor and Social Affairs together with National bank should provide wide level of information about investments and future pensions;
- b) Pension system should be connected with fertility rate and life expectancy;
- c) Pension system should be enough flexible and understandable for immigrants;
- d) Wide range of financial tools should accessible.

## References

- ADSS. (2019). *Údaje o dochodkových fondoch*. Retrieved from: <https://adss.sk/zhodnotenie-vo-fondoch>
- APFCR. (2019). *Účastnícké a transformované fondy*. Retrieved from: <https://www.apfcr.cz/ctvrtletni-vysledky-2019/>
- Breyer, F., & Wildasin, D. E. (2013). Steady-State Welfare Effects of Social Security in a Large Open Economy. *Journal of Economics*, 7, 43-49. doi: 10.1007/BF03052290
- Cifuentes, R. (1994). Changing the Pension Ages: The Welfare Effects. *Revista de Analisis Economico*, 9(1), 35-56. Retrieved from <https://www.rae-ear.org/index.php/rae/article/view/184>
- Cigno, A., & Rosati, F. A. (1997). Rise and fall of the Japanese saving rate: The role of social security and intra-family transfers. *Japan and the World Economy*, 9(1), 81-92. doi: 10.1016/S0922-1425(96)00238-1
- European Commission. (2012). *White Paper An Agenda for Adequate, Safe and Sustainable Pensions*. Retrieved from: <https://op.europa.eu/en/publication-detail/-/publication/32eda60f-d102-4292-bd01-ea7ac726b731>



- Hedesstrom, T. M., Svedsater, H., & Garling, T. (2007). Determinants of the Use of Heuristic Choice Rules in the Swedish Premium Pension Scheme an Internet-Based Survey. *Journal of Economic Psychology*, 28(1), 113-126. doi: 10.1016/j.joep.2006.04.002
- Homburg, S. & Richter, W. F. (2013). Harmonizing Public Debt and Public Pension Schemes in the European Community. *Journal of Economics*, 7, 51-63. doi: 10.1007/BF03052291
- OECD. (2017). *Pension Saving*. Retrieved from: [https://stats.oecd.org/OECDStat\\_Metadata/ShowMetadata.ashx?Dataset=PNNI\\_NEW&ShowOnWeb=true&Lang=en](https://stats.oecd.org/OECDStat_Metadata/ShowMetadata.ashx?Dataset=PNNI_NEW&ShowOnWeb=true&Lang=en)
- Patricio, A., & Schmidt-Hebbel, K. (1994). Pension Systems and Reforms: Country Experiences and Research issues. *World Bank Policy Research Working Paper No. 1470*. Retrieved from <https://ssrn.com/abstract=615023>
- Suden, A. (2004). How do individual accounts work in the Swedish pension? *Journal of the European Economic Association*, 5(2-3), 636-646. doi: 0.1162/jeea.2007.5.2-3.636

### Contact information

#### **Mgr. Raman Herasimau**

University of Economics in Bratislava  
Dolnozemska cesta 1, 85235, Bratislava, Slovakia  
E-mail: wfh@tut.by  
ORCID: 0000-0001-7698-5844

doi: 10.7441/dokbat.2019.034

# THE THEORY OF PLANNED BEHAVIOR TOWARD ORGANIC FOOD IN VIETNAM: THE MODERATION OF ENVIRONMENTAL CONCERN

*Hung Cuong Hoang, Miloslava Chovancová, Hoang Thi Que Huong,  
Abdul Bashiru Jibril*

## Abstract

With the increases in environmental concern, customers are more and more pay attention to purchase organic food. Despite purchase intention of customers toward organic food in many nations being commonly studied, there is a lack of research related to the moderation of environmental concern based on the Theory of Planned Behaviour (TPB). In this research, this study investigates the moderation of environmental concerns based on the theory of planned behaviour toward organic food in Vietnam. The methodology of mixed-methods of qualitative and quantitative is applied with a survey of 420 customers being conducted to collect data from three biggest cities in Vietnam: Ho Chi Minh, Da Nang and Ha Noi. The result shows that the customers have more environmental concern which increases their attitude to intention of purchasing organic food. This enriches the existing literature with the moderation of environmental concern to the relationship of attitude and purchase intention toward organic food in Vietnam based on the Theory of Planned Behaviour.

*Keywords: environmental concern, theory of planned behaviour, organic food, moderation, purchase intention*

## 1 INTRODUCTION

In recent decades the environmental concern (EC) has gradually increased (Han, Hsu, & Sheu, 2010). The ongoing and increasing overuse and depletion of natural resources like soil, land, and water is a major threat to human biodiversity. Consumers are aware of environmental issues in relation to their use, they are trying to buy products that are environmentally friendly (Paul, Modi, & Patel, 2016). Increased numbers of customers with various environmental problems start looking for and purchasing environmentally friendly products via alternatives, sometimes paying even more for these products (Laroche, Bergeron, & Barbaro-Forleo, 2001). In line with this trend, consumers' demand for green establishments has steadily increased in the lodging industry. Most consumers are aware of the damage to the community for the good of future generations. Although personal satisfaction remains central to consumer behaviour, preservation of the environment is also a key concern (Paul et al., 2016; Verbeke et al., 2007)

Empirical evidence is growing that environmental work focused on Theory of Planned Behaviour (TPB) is based on many dimensions, including tourism management (Han et al., 2010; Leelapattana et al., 2019; Wang et al., 2018), energy and waste (Li et al., 2019; Shen et al., 2019), green product consumption (Maichum, Parichatnon, & Peng, 2016; Paul et al., 2016; Yadav & Pathak, 2016). So far, scholars have published papers related to intention purchasing towards organic food. To have better understanding the purchasing intention used theory of planned behaviour, some studies have been investigated (Michaelidou & Hassan, 2008; Peighambari et al., 2016; Bonti-ankomah & Yiridoe, 2006) as well as empirical studies regarding factors influencing purchasing intention of organic food (Shaharudin et al., 2010; Singh & Verma, 2018); willingness to pay organic food (Aryal et al., 2009; Krystallis & Chryssohoidis, 2005; Zhang et al., 2018).

In the scope of expected Theory of Planned Behaviour (TPB) towards the purchasing of organic food, many researchers pay attention to the indirect and direct relationship between environmental concern (Chekima, Chekima, & Chekima, 2019; Pham et al., 2018; Yiridoe et al., 2014), but lacking of research related to how environmental concern impacts the relationship of personal attitude to purchase intention toward organic food. This study attempts to answer the following key research questions: the first question is whether the increase in environmental concern will increase the relationship of attitude to purchase intention toward organic food? The second is how is the influencing of factors in theory of planned behaviour to purchase intention? Therefore, research objectives of this study are: 1) to test the moderation of environmental concern in the Theory of Planned Behaviour (TPB) toward organic food in Vietnam, 2) to evaluate the relationship of personal attitude, subjective norms, and perceived behavioural control to purchase intention toward organic food in Vietnam.

The strength of this study to theory contribution is to update the moderation relationship of environmental concern based on theory of planned behaviour. In the practical fields, companies understand the importance of environmental concern of their customers. With launching many environmental activities, companies which producing organics food will increase the environmental concern of customers. It leads the raise in organic purchasing intention. The environment of the world and the health of human being would be better when using organic food. In the following section, Theory of Reasoned Action (TRA), TPB, and the conceptual framework that supports the research hypotheses are described. In the methodology section, measurement development, data collection and analysing are illustrated. Finally, study findings, implications, and conclusion are discussed in the results and conclusion sections.

## **2 LITERATURE REVIEW**

### **2.1 Theory background**

The theory of planned behaviour (TPB) is a cognitive model that targets to predict the intention and behaviour (Ajzen, 1991). This model has been widely used in various areas, such as health psychology (Walker, Grimshaw, & Armstrong, 2001; Zemore & Ajzen, 2014), environmental behaviour (Abrahamse & Steg, 2009), diet and food choice intention and actual behaviour (Arvola et al., 2008; Kim et al., 2013), green consumption (Al et al., 2018), intention of tourists and green hotel choices (Han et al., 2010; Wang et al., 2018).

From the Theory of Reasoned Action (TRA), The Theory of Planned Behaviour was developed (Fishbein & Ajzen, 1977). This model is a social psychological model describing behavioural intentions and actual behaviour based on attitude and subjective norm (Fishbein & Ajzen, 1977). For many factors, there are differences between actual behaviour and behavioural intention; in 1985, when the Theory of Planned Behaviour was written, Ajzen presented a further factor. The mediate variable is called "perceived behavioural control (PBC), which directly influences intention and behaviour.

In the Theory of Planned Behaviour, the first component of the model is intended to find out a "personal attitude" to the behaviour by determination of beliefs outcome and evaluation outcome. The outcome beliefs are related to what we believe to be the outcome of taking their behaviour and the outcome evaluation mentions how worthwhile we consider the outcome of the behaviour (Ajzen, 1991). The second part of the model aims to find out a person's "subjective norms" which is made of their normative beliefs and motivation to comply. The third part of the model looks at our personal control beliefs, which are made up of self- efficacy beliefs and perceived external barriers. The self- efficacy beliefs are about how confident we are we can achieve the change even in the face of barriers and the perceived external barriers

describe external factors that we perceive might prevent to achieve goals (Ajzen, 1991). Therefore, according to the Theory of Planned Behaviour (TPB), customers who have positive attitudes in regard to organic food, have normative support for using it, feel easy and comfortable to use this food, have strong intention to purchase this organic food.

## 2.2 Hypothesis development

In the Theory of Planned Behaviour, attitude refers to negative or positive evaluation related to behaviour investigation. There is an assumption that the more positive the attitude, the more possibly the intention (Nosi et al., 2017). Moreover, the more support of normative factor is, the more positive affect to purchase intention is. The normative support can be from parents, friends, or someone who has influences to. Besides, if customer feel comfortable to purchase organic food and it is easy for them to approach the purchasing this food, the relationship between perceived behavioural control and purchase intention is positive. There are many researches that prove the positive relationship between attitude of customer, subject norm, perceived behavioural control and purchase intention toward organic food (Arvola et al., 2008; Chen, 2007; Singh & Verma, 2018; Tsakiridou et al., 2008; Yazdanpanah & Forouzani, 2015). Thus, we posit that:

*H1: Attitude toward organic food will be positively related to purchase intention*

*H2: Subject norm toward organic positively affects purchase intention*

*H3: Perceived behaviour control positively affects purchase intention*

In this article, they argue that the relationship between attitude and purchase intention may depend on a number of boundary conditions that may alter the strength of this relationship. One constraint could be the extent or degree of environmental concern that may vary the strength of this relation. Firstly, according to Hu et al. (2010), environmental concerns is identified as "to the extent to which people are aware of environmental issues and endorse efforts to resolve them or to show their personal readiness to contribute to their solution" (Paul et al., 2016). Furthermore, researchers describe environmental concerns as being aware of environmental issues and their ability to tackle environmental challenges (Maichum et al., 2016). There are many researches proved the positive effect of environmental concern to purchase intention based on the theory of planned behaviour. For example, the study pointed out that the effect of ecological concerns and consumer purchase intentions for organic food (Pomsanam, Napompech, & Suwanmaneepong, 2014; Ragavan & Mageh, 2012); for the eco-friendly products and services (Aman, Harun, & Hussein, 2012; Han, Hsu, & Lee, 2009; Hartmann & Apaolaza-Ibañez, 2012). Sang and Bekhet (2015) reported a significant positive impact of environmental concern on consumer intention to buy an electric vehicle (Yadav & Pathak, 2016). Mostafa (2009) identified environmental concern among the major variables which influences consumers' attitude as well as their intention to buy green products. Mostafa (2007) also reported that environmental concern positively influences the consumers' attitude towards green products which further influences their green purchase intention.

However, Diamantopoulos et al. (2003) observed that environmental concerns are a significant consumer decision-making variable. Aman et al. (2012) noted that the incentive to purchase green products would be enhanced by an increasing number of consumers with environmental concern. Additional studies also show that environmental issues not only impact the behavioural will but also influence behavioural attitudes; consumers with greater environmental concern tend to adopt a more positive environmental attitude, which in turn increases their willingness to act (Chen & Peng, 2012; Clark, Kotchen, & Moore, 2003; Kalafatis et al., 1999). From the above arguments, the following hypothesis can be stated that:

*H4: The positive relationship between attitude and purchase intention will be stronger when environmental concern is high.*

Based on the above discussion a theoretical model can be developed:

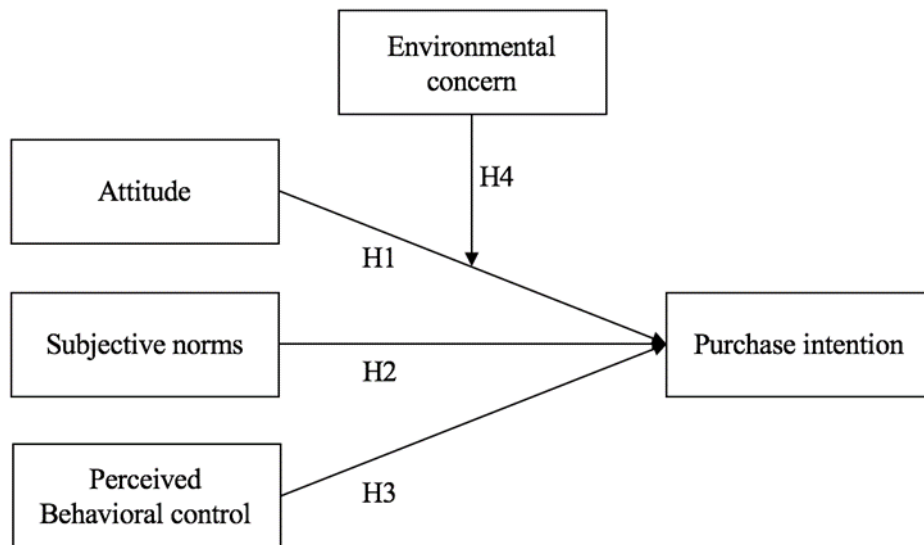

Fig. 1 – The proposed research framework. Source: own research

### 3 METHODOLOGY

#### 3.1 Research design

The study is applicable to both investigation approaches, including inductive and deductive methods. First, the inductive approach is used. This method seeks to gain a better understanding of organic purchasing and environmental concern. According to Saunders, Lewis, & Thornhill (2009), the strength of the inductive approach is to develop an understanding of the nature of the problem.

This study applied mixed-methods to investigate. According to Creswell (2014), one of the best ways to have a clear understanding of research problem is using mixed-methods. The mixed-methods is to incorporate the qualitative and quantitative data collection and analysis procedures which are employed either simultaneously or sequentially in a single study (Pham, Tučková, & Chiappetta Jabbour, 2019)

#### Qualitative research

Qualitative research is often defined as a study which aims at creating models instead of testing hypotheses (Bryman & Bell, 2011). Saunders et al. (2009) have mentioned that qualitative research is interpretive since scientists should recognize the significance of the chosen event or theme. Similar approaches are included in a qualitative process, for example: comprehensive interviews with people, action research reflection and team focal interviews. The purpose of the qualitative approach is to have a deep knowledge of a scenario or problem. This research focuses on the qualitative methodology with 10 Vietnamese customers, to identify and gain more understanding on planned behaviour theory and environment variable constructs

#### Quantitative research

Research objectives of this study aim to explore the effect of environmental concern on theory of planned behaviour toward organic food in Vietnam. Thus, the quantitative method is required

to achieve these objectives. The research strategy used in this study is survey. The survey research is to apply quantitative data collection, and is applied to measure the relationship between variables and propose the model (Saunders et al., 2009).

### 3.2 Data collection

#### Object of analysis

The ideal sample of this research is adults (18 years of age or older). More capacity for comparing and evaluating available options is related to adults. In addition, highly educated customer can give better understanding the topic with discussion and accreted providing of information as opposed to less well-educated people. (Han et al., 2010; Han & Kim, 2010; Hedlund, 2011). Hence, the data collection will be collected from consumers who have high education of above high school qualification.

#### Qualitative study

For the qualitative study, the focus group is conducted to collection data. The semi-structured interview is suitable for this stage. The objects of this interview are 10 customers who their age is 18 or over. The customers can be purchased organic food in the past or never purchase organic food.

#### Quantitative study

First of all, the questionnaire is developed with for five constructs: attitude, subjective norms, perceived behavioural control, purchase intention, and environmental concern. The study used measurement scales established in previous studies. The type scale applied for the measurement uses Likert of 5-point. Originally, questionnaire was written in English. The first author and a further bilingual scholar worked on this initial questionnaire in Vietnamese before it was translated into English. The data is collected by online using google form of questionnaire and offline by meeting directly customers. Three biggest cities in Vietnam chosen for this study are Ho Chi Minh City, Da Nang City, and Hanoi City. At the first stage, pilot study is conducted with sample of 70-100 customers. The purpose of this stage is to get more understanding of customer preparing for full study at the second stage. Another target is to estimate effect size for the full study. At the second stage, the full study is implemented with sample size which based on effect size of the pilot study. Moreover, the sample size sufficient for this research was calculated based upon the recommendation of Hair et al., (2013) for a desired level of 15 to 20 observations per variable examined. Our study consists of five constructs (6 items for attitude, 4 items for subjective norm items, 2 items for PBC, 6 environmental concern items and 4 purchase intention items, total of 22 items) resulting in an optimal sample size of 420 respondents. Table 1 illustrates the measurement scales for all constructs.

Tab. 1 – Measures description and properties. Source: own research

Measures	Item description	Fact. Load
Attitude (ATT) (Ajzen, 2002; Arvola et al., 2008)	X1: I think that purchasing organic food is interesting	0.724
	X2: I think that purchasing organic food is a good idea	0.807
	X3: I think that purchasing organic food is important	0.770
	X4: I think that purchasing organic food is beneficial	0.855
	X5: I think that purchasing organic food is wise	0.875
	X6: I think that purchasing organic food is favorable.	0.775
Subjective Norms (SBN) (Ajzen, 2002; Arvola et al., 2008)	X7: My family thinks that I should buy organic food rather than non-organic food	0.724
	X8: Most people I value would buy organic food rather than non-organic food	0.881
	X9: People I value (such as my teacher) think you should buy organic food	0.871

	X10: My close friends, whose opinions regarding diet are important to me, think that I should buy organic food	0.753
Perceived Behavioral Control (PBC) (Ajzen, 2002; Arvola et al., 2008)	X11: If I wanted to, I could buy organic food instead of non- organic food	0.772
	X12: I think it is easy for me to buy organic food	0,721
Environmental Concern (EC) (Kilbourne & Pickett, 2008; Maichum et al., 2016; Paul et al., 2016)	X13: I am very concerned about the environment	0.862
	X14: Humans are severely abusing the environment	0.840
	IX15: I would be willing to reduce my consumption to help protect the environment	0.661
	X16: Major political change is necessary to protect the natural environment	0.519
	X17: Major social changes are necessary to protect the natural environment	0.650
	X18: Anti-pollution laws should be enforced more strongly	0.856
Purchase Intention (PI) (Ajzen, 2002; Arvola et al., 2008)	X19: I am willing to consume organic food if they are available for purchase	0.840
	X20: I intend to consume organic food if they are available for purchase	0.911
	X21: I plan to consume organic food if they are available for purchase	0.859
	X22: I will try to consume organic food if they are available for purchase	0.782

### 3.3 Data analysis

#### Quantitative study

In respect to data analysis, the accuracy and quality of the measurement device was evaluated first. Then, regression was used to analyse the effect on TPB of environmental concerns. The PROCESS model was primarily used for clarifying interactive factors. The PROCESS model for SPSS programs were developed and implemented (Hayes & Rockwood, 2017). This process makes it easier to estimate regression equations because of its convenience and ease of use (Hayes & Rockwood, 2017). Moreover, SMART- PLS is applied to analyse the relationship between variable as well as to calculate the reliability and validity.

## 4 RESULTS

The sample characteristics analysis of the study is illustrated in the Table 2.

Tab. 2 – Sample characteristics. Source: own research

Variable	Categories	Frequency	Percentage
Gender	Male	192	46%
	Female	228	54%
Age	Less than 20 years	37	9%
	20–35 years	196	47%
	36–50 years	159	38%
	More than 50 years	28	7%
Marital Status	Single	245	58%
	Married	170	40%
	Divorced/Widow	5	1%
Family size	1 person	42	10%
	2–3 persons	153	36%
	4–5 persons	185	44%
	More than 5 persons	40	10%
Employment status	Full-time job	184	44%
	Part-time job	52	12%
	Student	69	16%

	Housewife	49	12%
	Unemployed	15	4%
	Business	51	12%
Education	High school	31	7%
	Diploma	63	15%
	Graduate	124	30%
	Post-graduate	182	43%
	Doctorate	20	5%
Personal income-monthly (Million VND)	less than 5000000	5	1%
	5000000-15000000	53	13%
	15000000-25000000	149	35%
	25000000-35000000	130	31%
	More than 35000000	83	20%

Hair et al. (2013) suggests that Cronbach's Alpha should be 0.7 or higher with an appropriate loading of 0.5 or higher for such measurements. Furthermore, the proportion of variance explained must exceed 50 percent. Table 3 shows that this finding meets the measurement reliability and validity criteria. Average Variance Extracted values (AVE) are higher than 0.5. Moreover, we used the approach used by (Fornell & Larcker, 1981) to assess discrimination by comparing square of AVE with square correlations between constructs. In Table 4, the square of AVE exceeds the squared correlations indicating discriminant validity (Paul et al., 2016).

Tab. 3 – Expected Reliability of scales. Source: own research

Variable	Item	Corrected Item-to-total correlation	Cronbach's $\alpha$	AVE	Composite Reliability
Attitude	ATT1	0.769	0.829	0.581	0.890
	ATT2	0.701			
	ATT3	0.789			
	ATT4	0.698			
	ATT5	0.739			
	ATT6	0.779			
Subjective norm	SBN1	0.749	0.761	0.656	0.883
	SBN2	0.641			
	SBN3	0.652			
	SBN4	0.761			
Perceived behavioral control	PBC1	0.743	0.689	0.635	0.694
	PBC2	0.656			
Environmental concern	EC1	0.718	0.787	0.504	0.853
	EC2	0.701			
	EC3	0.583			
	EC4	0.677			
	EC5	0.523			
	EC6	0.666			
Purchase intention	PI1	0.606	0.737	0.720	0.911
	PI2	0.597			
	PI3	0.666			
	PI4	0.557			

Tab. 3 – Expected discriminant validity. Source: own research

Construct	Attitude	Environmental control	Perceived behavioral control	Purchase intention	Subjective norm
Attitude	<b>0.762</b>				
Environmental control	0.375	<b>0.710</b>			
Perceived behavioral control	0.567	0.203	<b>0.751</b>		
Purchase intention	0.655	0.372	0.509	<b>0.849</b>	
Subjective norm	0.613	0.175	0.575	0.630	<b>0.810</b>



Tab. 4 – Evaluation of hypotheses testing. Source: own research

Hypotheses	Path	<i>t</i> -value	<i>p</i> -value	Hypotheses supported
H1	ATT → PI (+)	2.794	0.005	Yes
H2	SBN → PI (+)	2.336	0.020	Yes
H3	PBC → PI (+)	2.872	0.004	Yes
H4	ECxATT → PI (+)	2.454	0.005	Yes

Based on the analysis in Table 5, with  $p\text{-value} < 0,05$ , the analysis confirms the Theory of Planned Behaviour which illustrates the hypotheses supports of attitude, subjective norms and perceived behaviour control to purchase intention, supporting H1, H2, H3. Moreover, according to Table 5, the interaction of environmental concern and attitude ( $p\text{-value} < 0.05$ ) positively and significantly influences purchase intention, supporting H4. With the moderation effect of environmental concern to the relationship of attitude and purchase intention, the effect show that when environmental concern increase the relationship between attitude and purchase intention increase.

## 5 DISCUSSION AND CONCLUSIONS

Our findings are highlighted and discussed with respect to the two research questions as follows. Regarding the first research question, the study illustrates the moderation effect of environmental concern to the relationship of attitude and purchase intention. This indicate that extended TPB has higher utility than TPB and TRA to predict organic food purchase intention in Vietnam. Moreover, according to second research question, this study confirmed relationships in TPB as a research model useful for explaining consumers' organic food purchase intention.

The study's main contribution is that the interactive effect of Environmental concern (EC) and attitude is significant and positive to purchase intention. When consumers' attitude is positive and they display higher concern for environment, they will more likely make efforts to reduce their environmental impact and have more intention to buy organic food. In the practical fields, companies understand the importance of environmental concern of their customers. Companies which have more marketing campaigns toward to environmental concern will increase purchase intention of customers. It leads to increase in revenue as well as environment protection.

### Limitation and future research

The limitations of the study can be classified into two points. First, this study considers organic food only and this research model can be tested to another product in green area. Future research should test this proposed model in various green product settings, including recyclable products, green certified products, laundry and hotels. Second, more relevant variables like environmental knowledge, environmental awareness can be added to test model's sufficiency in predicting organic food purchase intentions.

### References

- Abrahamse, W., & Steg, L. (2009). How do socio-demographic and psychological factors relate to households' direct and indirect energy use and savings? *Journal of Economic Psychology*, 30(5), 711-720. doi: 10.1016/j.joep.2009.05.006
- Ajzen, I. (1991). The theory of planned behaviour. *Organizational Behaviour and Human Decision Processes*, 50(2), 179-211. doi: 10.1016/0749-5978(91)90020-T

- Ajzen, I. (2002). Perceived behavioural control, self-efficacy, locus of control, and the theory of planned behaviour. *Journal of Applied Social Psychology*, 32(4), 665-683. doi: 10.1111/j.1559-1816.2002.tb00236.x
- Al, A., Rosli, M., Ra, M., & Mohiuddin, M. (2018). Intention and behaviour towards green consumption among low-income households. *Journal of Environmental Management*, 227, 73-86. doi: 10.1016/j.jenvman.2018.08.061
- AlYahmady, H. H., & Abri, S. S. A. (2013). Using Nvivo for Data Analysis in Qualitative Research. *International Interdisciplinary Journal of Education*, 2(2), 181-186. doi: 10.12816/0002914
- Aman, A., Harun, A., & Hussein, Z. (2012). The influence of environmental knowledge and concern on green purchase intention the role of attitude as a mediating variable. *British Journal of Arts and Social Sciences*, 7(2), 145-167. Retrieved from <https://core.ac.uk/download/pdf/154907984.pdf>
- Arvola, A., Vassallo, M., Dean, M., Lampila, P., Saba, A., Lähteenmäki, L., & Shepherd, R. (2008). Predicting intentions to purchase organic food: The role of affective and moral attitudes in the Theory of Planned Behaviour. *Appetite*, 50(2-3), 443-454. doi: 10.1016/j.appet.2007.09.010
- Aryal, K. P., Chaudhary, P., Pandit, S., & Sharma, G. (2009). Consumers' Willingness to Pay for Organic Products: A Case from Kathmandu Valley. *Journal of Agriculture and Environment*, 10, 15. doi: 10.3126/aej.v10i0.2126
- Bonti-ankomah, S., & Yiridoe, E. K. (2006). *Organic and Conventional Food: A Literature Review of the Economics of Consumer Perceptions and Preferences*. Organic and Conventional Food: A Literature Review of the Economics of Consumer Perceptions and Preferences. Retrieved from [citeseerx.ist.psu.edu/viewdoc/download?doi=10.1.1.459.7393&rep=rep1&type=pdf](http://citeseerx.ist.psu.edu/viewdoc/download?doi=10.1.1.459.7393&rep=rep1&type=pdf)
- Bryman, A., & Bell, E. (2011). *Business research methods*. New York: Oxford University Press.
- Chekima, B., Chekima, K., & Chekima, K. (2019). Understanding factors underlying actual consumption of organic food: The moderating effect of future orientation. *Food Quality and Preference*, 74, 49-58. doi: 10.1016/j.foodqual.2018.12.010
- Chen, A., & Peng, N. (2012). Green hotel knowledge and tourists' staying behaviour. *Annals of Tourism Research*, 39(4), 2211-2216. doi: 10.1016/j.annals.2012.07.003
- Chen, M. F. (2007). Consumer attitudes and purchase intentions in relation to organic food in Taiwan: Moderating effects of food-related personality traits. *Food Quality and Preference*, 18(7), 1008-1021. doi: 10.1016/j.foodqual.2007.04.004
- Clark, C. F., Kotchen, M. J., & Moore, M. R. (2003). Internal and external influences on pro-environmental behaviour: Participation in a green electricity program. *Journal of Environmental Psychology*, 23(3), 237-246. doi: 10.1016/S0272-4944(02)00105-6
- Creswell, J. W. (2014). *Research design: qualitative, quantitative, and mixed methods approaches*. Thousand Oaks: SAGE Publications.
- Diamantopoulos, A., Schlegelmilch, B. B., Sinkovics, R. R., & Bohlen, G. M. (2003). Can socio-demographics still play a role in profiling green consumers? A review of the evidence and an empirical investigation. *Journal of Business Research*, 56(6), 465-480. doi: 10.1016/S0148-2963(01)00241-7

- Fishbein, M., & Ajzen, I. (1977). Belief, Attitude, Intention, and Behaviour: An Introduction to Theory and Research. *Journal of Business Venturing*, 5, 177-189. doi: 10.2307/2065853
- Fornell, C., & Larcker, D. F. (1981). Evaluating Structural Equation Models with Unobservable Variables and Measurement Error. *Journal of Marketing Research*, 18(1), 39. doi: 10.2307/3151312
- Hair, J., Black, W. C., Babin, B. J., & Anderson, R. E. (2013). *Multivariate Data Analysis: Pearson New International Edition*. London: Pearson.
- Han, H., Hsu, L. T., & Lee, J. S. (2009). Empirical investigation of the roles of attitudes toward green behaviours, overall image, gender, and age in hotel customers' eco-friendly decision-making process. *International Journal of Hospitality Management*, 28(4), 519-528. doi: 10.1016/j.ijhm.2009.02.004
- Han, H., Hsu, L. T., & Sheu, C. (2010). Application of the Theory of Planned Behaviour to green hotel choice: Testing the effect of environmental friendly activities. *Tourism Management*, 31(3), 325-334. doi: 10.1016/j.tourman.2009.03.013
- Han, H., & Kim, Y. (2010). An investigation of green hotel customers' decision formation: Developing an extended model of the theory of planned behaviour. *International Journal of Hospitality Management*, 29(4), 659-668. doi: 10.1016/j.ijhm.2010.01.001
- Hartmann, P., & Apaolaza-Ibáñez, V. (2012). Consumer attitude and purchase intention toward green energy brands: The roles of psychological benefits and environmental concern. *Journal of Business Research*, 65(9), 1254-1263. doi: 10.1016/j.jbusres.2011.11.001
- Hayes, A. F., & Rockwood, N. J. (2017). Regression-based statistical mediation and moderation analysis in clinical research: Observations, recommendations, and implementation. *Behaviour Research and Therapy*, 98, 39-57. doi: 10.1016/j.brat.2016.11.001
- Hedlund, T. (2011). The impact of values, environmental concern, and willingness to accept economic sacrifices to protect the environment on tourists' intentions to buy ecologically sustainable tourism alternatives. *Tourism and Hospitality Research*, 11(4), 278-288. doi: 10.1177/1467358411423330
- Hu, H. H., Parsa, H. G., & Self, J. (2010). The dynamics of green restaurant patronage. *Cornell Hospitality Quarterly*, 51(3), 344-362. doi: 10.1177/1938965510370564
- Kalafatis, S. P., Pollard, M., East, R., & Tsogas, M. H. (1999). Green marketing and Ajzen's theory of planned behaviour: A cross-market examination. *Journal of Consumer Marketing*, 16(5), 441-460. doi: 10.1108/07363769910289550
- Kilbourne, W., & Pickett, G. (2008). How materialism affects environmental beliefs, concern, and environmentally responsible behaviour. *Journal of Business Research*, 61(9), 885-893. doi: 10.1016/j.jbusres.2007.09.016
- Kim, E., Ham, S., Yang, I. S., & Choi, J. G. (2013). The roles of attitude, subjective norm, and perceived behavioural control in the formation of consumers' behavioural intentions to read menu labels in the restaurant industry. *International Journal of Hospitality Management*, 35, 203-213. doi: 10.1016/j.ijhm.2013.06.008
- Krystallis, A., & Chrysosoidis, G. (2005). Consumers' willingness to pay for organic food. *British Food Journal*, 107(5), 320-343. doi: 10.1108/00070700510596901

- Laroche, M., Bergeron, J., & Barbaro-Forleo, G. (2001). Targeting consumers who are willing to pay more for environmentally friendly products. *Journal of Consumer Marketing*, 18(6), 503-520. doi: 10.1108/EUM00000000006155
- Leelapattana, W., Hsu, S. Y., Thongma, W., Chen, C., & Chiang, F. M. (2019). Understanding the impact of environmental education on tourists' future Visit Intentions to Leisure Farms in Mountain Regions. *Sustainability*, 11(6), 1567. doi: 10.3390/su11061567
- Li, G., Li, W., Jin, Z., & Wang, Z. (2019). Influence of environmental concern and knowledge on households' willingness to purchase energy-efficient appliances: A case study in Shanxi, China. *Sustainability*, 11(4), 1-18. doi: 10.3390/su11041073
- Maichum, K., Parichatnon, S., & Peng, K. C. (2016). Application of the extended theory of planned behaviour model to investigate purchase intention of green products among Thai consumers. *Sustainability*, 8(10), 1-20. doi: 10.3390/su8101077
- Michaelidou, N., & Hassan, L. M. (2008). The role of health consciousness, food safety concern and ethical identity on attitudes and intentions towards organic food. *International Journal of Consumer Studies*, 32(2), 163-170. doi: 10.1111/j.1470-6431.2007.00619.x
- Mostafa, M. M. (2007). A Hierarchical Analysis of the Green Consciousness of the Egyptian Consumer. *Psychology & Marketing*, 24(05), 445-473. doi: 10.1002/mar
- Mostafa, M. M. (2009). Shades of green: A psychographic segmentation of the green consumer in Kuwait using self-organizing maps. *Expert Systems with Applications*, 36(8), 11030-11038. doi: 10.1016/j.eswa.2009.02.088
- Nosi, C., Pucci, T., Silvestri, C., & Aquilani, B. (2017). Does value co-creation really matter? An investigation of Italian millennials intention to buy electric cars. *Sustainability*, 9(12), 1-21. doi: 10.3390/su9122159
- Paul, J., Modi, A., & Patel, J. (2016). Predicting green product consumption using theory of planned behaviour and reasoned action. *Journal of Retailing and Consumer Services*, 29, 123-134. doi: 10.1016/j.jretconser.2015.11.006
- Peighambari, K., Sattari, S., Kordestani, A., & Oghazi, P. (2016). Consumer Behaviour Research: A Synthesis of the Recent Literature. *SAGE Open*, 6(2). doi: 10.1177/2158244016645638
- Pham, N. T., Tučková, Z., & Chiappetta Jabbour, C. J. (2019). Greening the hospitality industry: How do green human resource management practices influence organizational citizenship behaviour in hotels? A mixed-methods study. *Tourism Management*, 72(August), 386-399. doi: 10.1016/j.tourman.2018.12.008
- Pham, T. H., Nguyen, T. N., Phan, T. T. H., & Nguyen, N. T. (2018). Evaluating the purchase behaviour of organic food by young consumers in an emerging market economy. *Journal of Strategic Marketing*, 4488, 1-17. doi: 10.1080/0965254X.2018.1447984
- Pomsanam, P., Napompech, K., & Suwanmaneepong, S. (2014). An exploratory study on the organic food purchase intention among Thai-Cambodian cross-border consumers. *Asian Journal of Applied Sciences*. doi: 10.3923/ajaps.2014.294.305
- Ragavan, & Mageh. (2012). A Study on Consumers' Purchase Intentions Towards Organic Products. *Paripex - Indian Journal of Research*, 2(1), 111-114. doi: 10.15373/22501991/jan2013/41

- Sang, Y. N., & Bekhet, H. A. (2015). Modelling electric vehicle usage intentions: An empirical study in Malaysia. *Journal of Cleaner Production*, 92, 75-83. doi: 10.1016/j.jclepro.2014.12.045
- Saunders, M. N. K., Lewis, P., & Thornhill, A. (2009). *Research methods for business students*. Harlow: Pearson.
- Shaharudin, M. R., Pani, J. J., Mansor, W. S., & Elias, J. S. (2010). Factors Affecting Purchase Intention of Organic Food in Malaysia' s Kedah State. *Cross-Cultural Communication*, 6(2), 105-116. Retrieved from [https://www.researchgate.net/publication/44926510\\_Factors\\_Affecting\\_Purchase\\_Intention\\_of\\_Organic\\_Food\\_in\\_Malaysia's\\_Kedah\\_State](https://www.researchgate.net/publication/44926510_Factors_Affecting_Purchase_Intention_of_Organic_Food_in_Malaysia's_Kedah_State)
- Shen, L., Si, H., Yu, L., & Si, H. (2019). Factors influencing young people's intention toward municipal solid waste sorting. *International Journal of Environmental Research and Public Health*, 16(10). doi: 10.3390/ijerph16101708
- Singh, A., & Verma, P. (2018). Factors influencing Indian consumers' actual buying behaviour towards organic food products. *Journal of Cleaner Production*, 167, 473-483. doi: 10.1016/j.jclepro.2017.08.106
- Tsakiridou, E., Boutsouki, C., Zotos, Y., & Mattas, K. (2008). Attitudes and behaviour towards organic products: an exploratory study. *International Journal of Retail & Distribution Management*, 36(2), 158-175. doi: 10.1108/09590550810853093
- Verbeke, W., Sioen, I., Brunsø, K., Henauw, S., & Camp, J. (2007). Consumer perception versus scientific evidence of farmed and wild fish: Exploratory insights from Belgium. *Aquaculture International*, 15(2), 121-136. doi: 10.1007/s10499-007-9072-7
- Walker, A. E., Grimshaw, J. M., & Armstrong, E. M. (2001). Salient beliefs and intentions to prescribe antibiotics for patients with a sore throat. *British Journal of Health Psychology*, 6(4), 347-360. doi: 10.1348/135910701169250
- Wang, C., Zhang, J., Yu, P., & Hu, H. (2018). The theory of planned behaviour as a model for understanding tourists' responsible environmental behaviours: The moderating role of environmental interpretations. *Journal of Cleaner Production*, 194, 425-434. doi: 10.1016/J.JCLEPRO.2018.05.171
- Whitmarsh, L., & O'Neill, S. (2010). Green identity, green living? The role of pro-environmental self-identity in determining consistency across diverse pro-environmental behaviours. *Journal of Environmental Psychology*, 30(3), 305-314. doi: 10.1016/j.jenvp.2010.01.003
- Yadav, R., & Pathak, G. S. (2016). Young consumers' intention towards buying green products in a developing nation: Extending the theory of planned behaviour. *Journal of Cleaner Production*, 135, 732-739. doi: 10.1016/j.jclepro.2016.06.120
- Yazdanpanah, M., & Forouzani, M. (2015). Application of the Theory of Planned Behaviour to predict Iranian students' intention to purchase organic food. *Journal of Cleaner Production*, 107, 342-352. doi: 10.1016/j.jclepro.2015.02.071
- Yiridoe, E. K., Tsakiridou, E., Boutsouki, C., Zotos, Y., Mattas, K., Shaharudin, M. R., & Sharma, G. (2014). Attitudes and behaviour towards organic products: an exploratory study. *International Journal of Business Excellence*, 10(2), 320-343. doi: 10.3126/aej.v10i0.2126

Zemore, S. E., & Ajzen, I. (2014). Predicting substance abuse treatment completion using a new scale based on the theory of planned behaviour. *Journal of Substance Abuse Treatment*, 46(2), 174-182. doi: 10.1016/j.jsat.2013.06.011

Zhang, B., Fu, Z., Huang, J., Wang, J., & Xu, S. (2018). Consumers' perceptions, purchase intention, and willingness to pay a premium price for safe vegetables: A case study of Beijing, China Conventional vegetable. *Journal of Cleaner Production*, 197, 1498-1507. doi: 10.1016/j.jclepro.2018.06.273

### **Contact information**

#### **Hung Cuong Hoang**

Tomas Bata University in Zlín, Faculty of Management and Economics  
Mostní 5139, 76001, Zlín, Czech Republic  
E-mail: hoang@utb.cz  
ORCID: 0000-0003-0732-8319

#### **Thi Que Huong Hoang**

University of Economics and Law, Faculty of International Economic Relations  
Quarter 3, Linh Xuan Ward, Thu Duc District, Ho Chi Minh City  
E-mail: huongtq@uel.edu.vn  
ORCID: 0000-0002-0111-0004

#### **doc. Ing. Miloslava Chovancová, CSc.**

Tomas Bata University in Zlín, Faculty of Management and Economics  
Mostní 5139, 76001, Zlín, Czech Republic  
E-mail: chovancova@utb.cz  
ORCID: 0000-0002-9244-9563

#### **Abdul Bashiru Jibril**

Tomas Bata University in Zlín, Faculty of Management and Economics  
Mostní 5139, 76001, Zlín, Czech Republic  
E-mail: jibril@utb.cz  
ORCID: 0000-0003-4554-0150

doi: 10.7441/dokbat.2019.035

# ASSESSING THE IMPACT OF GLOBAL DIGITAL ENVIRONMENT ON THE ONLINE REPUTATION OF SELECTED CAR BRANDS IN SLOVAK AND GLOBAL MARKET

*Vladimír Hojdík*

## **Abstract**

Reputation is one of the most important factors which impacts the perception of company in public. A positive corporate reputation is widely considered as an asset which can result in many benefits for company and thus improve its performance. The importance of corporate reputation is unquestionable and this suggestion is even more appropriate in context of digital environment. The potential of the Internet and digital technologies is raising which causes that companies are forced to manage their reputation in the online environment, too. Online reputation of company is influenced by multiple influences. Especially social media are currently important factor, that impacts the level of corporate reputation in online environment. This fact puts the pressure on companies to be actively involved in social media communication. In addition, companies should be also interested in assessing the level of their online reputation. But this is the problem: online reputation assessment is very complex issue, and possibilities or methods of its measurement are still very limited and insufficient. However, the data obtained from most popular social media offer valuable information for companies considering their online reputation. Metrics such as number of fans, followers or subscribers inform about the popularity of company in online environment. These metrics are therefore suitable for corporate online reputation assessment as they enable companies to compare themselves to competition or whole sector. The aim of this paper is to bring the issue of online reputation measurement and evaluate the level of online reputation of selected car brands in both Slovak and global social media environment, based on data obtained by social media analysis

*Keywords:* online reputation, online reputation management, car brands, social media

## **1 INTRODUCTION**

Reputation is one of the most important factors for obtaining and retaining customer trust, which is true not only in real but increasingly also in the digital environment of the Internet (Gottschalk, 2011). The building of corporate reputation has a long-lasting character and significant role in this process is played by the feelings and experiences of people who came to contact with specific company (or product of company). The issue of reputation is now receiving more attention from businesses than ever before, and that is because of the increasing turbulence of the environment. Becoming a strong market player is no longer just a matter of know-how, a unique product, passionate business will or enterprise flexibility. The vision of a successful company already includes the building of a positive reputation, which is one of the key elements for improving the competitive position (Dorčák et al., 2014). Based on this suggestion, the reputation of the company significantly influences corporate results.

Companies are currently facing many challenges, mainly due to the rapid development of digital technologies. This means that getting a positive reputation applies not only to the real world but also to the online environment. The reputation in the online environment (also called online reputation) and its acquisition, maintenance and management are extremely important

determinants of business success. Properly designed marketing strategy and appropriate marketing tools are the basis for building corporate reputation. Subsequently, the efficient use of online marketing tools has direct impact on online reputation of company. Nowadays, online reputation management is closely related to social media. Popularity of biggest social media cannot be overlooked by companies, if they want to succeed in highly competitive market. This suggestion also applies to car brands – these companies realize their business activities worldwide, and for them the level of reputation is direct determinant of success.

## **2 ONLINE REPUTATION AND ONLINE REPUTATION MANAGEMENT (ACCORDING TO HOJDIK – MAJTÁN, 2017)**

Corporate reputation is a reflection of how other stakeholders are regarding a company. According to Baur and Schmitz (2011), an organization's reputation can lead to trust and credibility in society, and thus help the company to achieve its goals and objectives.

Each company has some reputation and as Marsden (2013) claims, reputation always exists. According to Balmer and Greyser (2003), the reputation of company is formed over a long time and relates to what the company does and how it is maintained. For this reason, corporate reputation is nowadays considered as a very valuable asset.

Online reputation is a reputation of company in online environment, and it is very important element which impacts its success. Walter (2013) brings very interesting idea as he says business reputation is everything – it is very fragile and only one mistake can damage it completely. All these suggestions are even more intense in the online environment. Nowadays, people or customers can easily express their opinion about the brand and share it via the Internet. Such comments and similar online interactions are creating the online reputation, and therefore companies should take an active approach in its management.

The rise of the Internet is accompanied by the fact that what used to be local, is now global and what used to be private, is now public. This shift is a consequence of technological development and growing number of the Internet users. Worldwide popularity of social media caused that spreading of information is not a matter of days, but hours or seconds.

The issue of online reputation management is still an undiscovered area, especially in terms of Slovak market. Even though companies are interested about brand protection and brand awareness, the problem of online reputation management remains quite unknown. Online reputation management is the process of analysis and management of entities reputation (people, organizations), which is characterized by the existent content on the Internet and within all kinds of online media. Very important for organizations is the ability to monitor the online environment and to answer fast enough when people express their opinions about them (Hung et al., 2012).

Online reputation management is based on monitoring media, detecting relevant contents, analysing what people say about company and interact with consumers, too. Especially negative comments may influence reputation of company. Comments with negative sentiment can seriously affect the corporate reputation in negative way and therefore online reputation management is becoming increasingly important part of company communication.

As Sasko (2014) outlines, online reputation management consists of these four main activities:

- a) online monitoring of the Internet and users;
- b) communication with clients and public;
- c) evaluation and interpretation of results;



d) crisis reputation management.

As Portmann (2013) says, the process of online reputation management has these stages: identification, analysis, reaction and controlling. Identification represents the stage in which entities should search for potential issues or risks that could lead to negative reputation. Depending on the business/industry, these activities need to be constantly developed and then monitored. For the success of this step, inclusion of employees in the monitoring process could eventually result in higher added value for the organization. The analysis stage follows the stage of identification – the identified issues need to be analysed and included in the business strategies. The process then continues with the reaction stage – actions for an appropriate business strategy should be developed and implemented. Control stage that represents the evaluation of the actions implemented for improvement is a final stage of the process. What is very important for the whole process is the fact, that it need to be improved and maintained over time.

Activities of online reputation management should protect the reputation of person, brand or business in the Internet and eliminate the causes of negative sentiment. To do this, companies should find out, what is written about them in the Internet, identify a potential cause of negative image and act appropriately towards the audience.

The principle of online reputation management expresses the need for monitoring the Internet as a whole: watch online discussions, discussions forums, search engine results and even communicate with the public. The essential aspect for the entities is having as many positive online references as possible. Such positive sentiment supports corporate reputation and image. It is therefore important to monitor crucial factors which dominantly influence the level of online reputation, especially:

- a) carefully manage the website of company;
- b) actively operate and communicate on the social media;
- c) create and publish relevant content that is attractive for target group of company;
- d) ensure that positive references about the entity on the Internet are clearly visible and push negative references into the background (Hojdik – Majtán, 2018).

However, for companies it is very important to evaluate the level of online reputation. The truth is, there are indicators of online reputation measurement, but their quality is insufficient to reflect current specifics of online world. Above mentioned indicators include especially sentiment analysis, and multifactor sentiment analysis.

Sentiment analysis was firstly proposed and used by Rohál' and Sasko (2011). Sentiment analysis (or advanced sentiment analysis) evaluates results found by search engine after typing a searched keyword. Multifactor sentiment analysis expands the idea of sentiment analysis by adding next factors (social media, number of pages indexed by search engine etc.) and allows more detailed analysis of corporate online reputation. Multifactor sentiment analysis was firstly used in research of Dorčák and Pollák (2013) and was thoroughly explained by Pollák (2015). Multifactor sentiment analysis is represented by indicator TOR score which construction is following:

$$TOR = \frac{R_{ASA} + \sum_{i=1}^n R_i}{n + 1} \quad (1)$$

$TOR$  – total online reputation score (%);

$R_i$  – partial score of  $i$ -factor of reputation (%);

$R_{ASA}$  – partial score of reputator ASA (advanced sentiment analysis);

n – number of factors of reputation.

### **3 METHODOLOGY**

The aim of the paper is to evaluate the level of reputation of selected car brands on the most popular social media – Facebook, Instagram, YouTube and Twitter. For evaluation, we used modified version of multifactor sentiment analysis as we focused strictly on social media. We also did not evaluate complex TOR score, but we analysed each partial result separately. The key metric of the study is the size of the audience, the number of fans (Facebook), followers (Instagram and Twitter) or subscribers (YouTube). Audience size is indicator that depicts the quality of marketing activities of car brands in the online environment, thus it is important factor of building positive reputation of brand.

The research sample of the study contains 21 car brands with the highest market share according to the number of cars sold on the Slovak market for the year 2017. Data were collected from a survey of the Internet, especially from the social media, and were completed for official Slovak and global car brands profiles on Facebook, Instagram, YouTube and Twitter. All data about the size of audience were then transformed into a relative numbers (%) for a better comparability of results found. The research sample consisted of the following car brands: Audi, BMW, Citroen, Dacia, Fiat, Ford, Honda, Hyundai, KIA, Mazda, Mercedes Benz, Mitsubishi, Nissan, Opel, Peugeot, Renault, Seat, Suzuki, Škoda, Toyota, Volkswagen. Data about audience size of car brands were obtained during the period of March of 2019. Based on the obtained data, it was also possible to evaluate the distribution of power of car brands in terms of their presence in the Slovak and global social media environment.

### **4 ONLINE REPUTATION OF CAR BRANDS ON THE SOCIAL MEDIA**

In this chapter, there are summarized and evaluated all the data needed for the purpose of the research. As mentioned above, the collection of relevant data was necessary in order to follow the aim of the paper – to evaluate the level of online reputation of car brands in Slovak and global digital environment. Following tables (Tab. 1 – Tab. 8) contain data about the audience size of brands on social media (Facebook, Instagram, YouTube and Twitter) and inform about the level of online reputation of analysed car brands (Tab. 9 and Tab. 10).

Tables 1 to 8 create a database for purposes of the research. Data listed in these tables are subsequently explained in the paper. In addition, data show what is the quality level of marketing communication of brands in global and Slovak online environment of most popular social media. In tables 9 and 10 (Tab. 9 and Tab. 10), there are completed data about online reputation of brands in global and Slovak digital environment according to their relative score (%). Relative score represents the level of online reputation within selected social media platforms. The level of relative score was calculated for each brand. For example, relative scores of brands in global Facebook environment were calculated as follows: Volkswagen with approximately 33 million global fans on Facebook is leading brand and thus its score is 100% (FB=100%). Audience size of all other brands were compared to Volkswagen. Second place is occupied by Nissan (more than 21 million of fans) and its relative score is then  $21\,411\,692/33\,799\,811 * 100 = 63,35\%$ . The same approach was applied for calculation of relative scores of all other brands in both, global and Slovak social media environment.

Tab. 1 – Audience size of brands for Global Facebook profile. Source: own research

	<b>Brand</b>	<b>Facebook (fans)</b>
1	Volkswagen	33 799 811
2	Nissan	21 411 692
3	Mercedes Benz	20 948 147
4	BMW	20 233 341
5	Renault	18 915 826
6	Ford	15 724 089
7	Peugeot	12 595 170
8	Audi	11 222 243
9	Citroen	10 643 111
10	Toyota	7 394 593
11	Seat	5 575 707
12	Honda	4 928 690
13	Hyundai	4 725 262
14	KIA Motors	4 298 919
15	Opel	4 119 095
16	Fiat	3 975 045
17	Dacia	3 905 111
18	Škoda	1 065 124
19	Mitsubishi	1 025 221
20	Mazda	442 866
21	Suzuki	171 993

Tab. 2 – Audience size of brands for Slovak Facebook profile. Source: own research

	<b>Brand</b>	<b>Facebook (fans)</b>
1	BMW	170 954
2	Volkswagen	118 568
3	Hyundai	80 366
4	Škoda	77 448
5	Audi	66 242
6	Kia	62 427
7	Mercedes Benz	56 875
8	Citroen	45 540
9	Renault	42 907
10	Peugeot	42 371
11	Fiat	38 855
12	Toyota	31 215
13	Nissan	26 582
14	Seat	22 672
15	Dacia	21 519
16	Opel	19 563
17	Ford	16 580
18	Mazda	15 228
19	Honda	6 993
20	Mitsubishi	6 872
21	Suzuki	6 695

From the data listed in Table 1 it is clear, that Volkswagen is dominant car brand according to the number of global Facebook fans. The official global profile of this German brand is currently followed by more than 33 million fans. Nissan and Mercedes Benz make up the TOP3, with more than 20 million of fans. BMW placed in fourth place of the rankings and reached 20 million level as well. On the bottom of the table there are brands like Mitsubishi, Mazda or Suzuki. Table 2 summarizes data from Slovak official profiles of the brands. BMW, Volkswagen and Hyundai are three strongest brands according to the size of Slovak audience. The difference between the global and Slovak audience size is significant, but not very surprising. However, we can see interesting changes in the rankings of brands in Table 1 and Table 2. For example, Škoda placed very low (18th place) for global Facebook audience size, but it has much stronger position in Slovak Facebook environment (4th place). On the other hand, the power of Ford is considerably higher in global Facebook environment (6th place) than in Slovak (17th place). Comparison of data from both tables shows differences between brand rankings in global and Slovak Facebook audience size.

Tables 3 and 4 contain data about Instagram followers of brands – in global and Slovak online environment, too. For global data, the German trinity (BMW, Mercedes Benz and Volkswagen) hold top three spots of the rankings. Especially BMW and Mercedes Benz with 19 and 18 million of followers have built very strong online reputation on Instagram. These three brands confirmed their power also for Slovak Instagram environment (placing in 2nd, 3rd and 4th place), where another German player is a leader – Audi. Data about Instagram audience refer to high contrast between brands strategy of their online reputation management. While some of them (for example German brands mentioned above) are aware of the potential of Instagram, others underrate this platform and do not even own the official profile (Suzuki or Mazda).

Tab. 3 – Audience size of brands for Global Instagram profile. Source: own research

	<b>Brand</b>	<b>Instagram (followers)</b>
1	BMW	19 505 798
2	Mercedes Benz	18 249 029
3	Volkswagen	5 282 904
4	Nissan	3 755 219
5	Ford	3 487 404
6	Honda	3 300 074
7	Toyota	1 186 711
8	Hyundai	615 273
9	Audi	463 234
10	Peugeot	437 412
11	KIA Motors	346 775
12	Fiat	330 276
13	Citroen	301 118
14	Opel	226 035
15	Mitsubishi	187 494
16	Škoda	146 653
17	Renault	139 666
18	Seat	80 710
19	Dacia	1210
20	Suzuki	-
21	Mazda	-

Tab. 4 – Audience size of brands for Slovak Instagram profile. Source: own research

	<b>Brand</b>	<b>Instagram (followers)</b>
1	Audi	11 156
2	BMW	9 023
3	Volkswagen	8 820
4	Mercedes Benz	7 028
5	Škoda	6 766
6	Citroen	5 260
7	Ford	3 636
8	Mazda	3 465
9	Peugeot	3 325
10	Hyundai	3 193
11	Seat	2 340
12	Kia	2 193
13	Renault	1 654
14	Mitsubishi	1 501
15	Dacia	1 226
16	Suzuki	877
17	Fiat	397
18	Toyota	341
19	Opel	278
20	Nissan	248
21	Honda	-

Tab. 5 – Audience size of brands for Global YouTube profile. Source: own research

	<b>Brand</b>	<b>YouTube (subscribers)</b>
1	Ford	1 924 222
2	Mercedes Benz	886 192
3	BMW	840 042
4	Audi	551 763
5	Honda	378 962
6	Toyota	293 720
7	Hyundai	176 041
8	KIA Motors	143 408
9	Volkswagen	135 873
10	Nissan	67 446
11	Peugeot	59 263
12	Renault	57 818
13	Mazda	57 241
14	Opel	42 576
15	Škoda	41 700
16	Suzuki	41 207
17	Fiat	39 594
18	Citroen	21 311
19	Seat	20 703
20	Mitsubishi	12 247
21	Dacia	7 607

Tab. 6 – Audience size of brands for Slovak YouTube profile. Source: own research

	<b>Brand</b>	<b>YouTube (subscribers)</b>
1	Ford	3 522
2	BMW	3 376
3	Škoda	2 951
4	Volkswagen	2 590
5	Kia	1 998
6	Audi	1 736
7	Peugeot	1 272
8	Seat	1 171
9	Nissan	1 158
10	Hyundai	897
11	Renault	758
12	Mercedes Benz	429
13	Mazda	422
14	Dacia	414
15	Mitsubishi	412
16	Honda	359
17	Toyota	327
18	Fiat	303
19	Suzuki	163
20	Citroen	162
21	Opel	81

According to the number of YouTube subscribers (Tab. 5 and Tab. 6), Ford (almost 2 million audience) has a solid lead over the second-placed Mercedes Benz and third BMW. Other brands possess significantly lower YouTube audience and Dacia or Mitsubishi found themselves again on the back of the rankings. In Slovak YouTube environment, Ford underlines its strong position and sits on the top also in this case. Behind Ford, BMW and Škoda also belong to TOP3. Interesting fact is linked to Mercedes Benz – this brand holds 2nd place in global YouTube rankings (Table 5), but within the Slovak YouTube environment it has only average position (12th place).

In tables 7 and 8 are completed data about Twitter followers of brands. From the global perspective, Mercedes Benz safely placed in the 1st place with 3,3 million followers, while Audi with BMW took 2nd and 3rd positions with 1,9 and 1,8 million followers. This fact again points out to stable positions of these German car brands in digital world. Despite high

popularity of Twitter worldwide, some car brands simply do not pay attention to this platform and the size of its audience is very small in comparison to leading trio. Moreover, Suzuki, which is globally known car producer and reseller do not even run its official profile on Twitter, which cannot be considered as good strategic decision in terms of online reputation management. On the bottom of rankings, we again see the same brands, as Škoda or Dacia.

Even more interesting is the look on the Table 8. It is obvious, that owning Slovak official profile on Twitter remains on the edge of interest of analysed brands. From totally 21 brands, only 9 of them own their official Slovak Twitter profile. However, brands like Mercedes Benz and BMW proved also in this case, that they are serious about complex online reputation strategy, and dominantly filled two top places.

Tab. 7 – Audience size of brands for Global Twitter profile. Source: own research

	<b>Brand</b>	<b>Twitter (followers)</b>
1	Mercedes Benz	3 325 771
2	Audi	1 967 846
3	BMW	1 839 789
4	Ford	1 153 852
5	Honda	963 003
6	Toyota	748 129
7	Nissan	738 410
8	Mazda	328 208
9	Mitsubishi	250 707
10	KIA Motors	227 991
11	Fiat	164 512
12	Peugeot	147 872
13	Volkswagen	130 173
14	Renault	130 063
15	Citroen	119 879
16	Opel	101 101
17	Hyundai	67 579
18	Seat	18 703
19	Dacia	11 502
20	Škoda	8 295
21	Suzuki	-

Tab. 8 – Audience size of brands for Slovak Twitter profile. Source: own research

	<b>Brand</b>	<b>Twitter (followers)</b>
1	BMW	2 055
2	Mercedes Benz	1 159
3	Kia	508
4	Fiat	462
5	Nissan	310
6	Audi	113
7	Citroen	50
8	Mitsubishi	19
9	Suzuki	13
10	Peugeot	-
11	Škoda	-
12	Volkswagen	-
13	Hyundai	-
14	Dacia	-
15	Seat	-
16	Toyota	-
17	Ford	-
18	Honda	-
19	Mazda	-
20	Opel	-
21	Renault	-

Tab. 9 – Online reputation of brands for Global environment quantified as relative score. Source: own research

<b>Brand</b>	<b>FB(%)</b>	<b>IN(%)</b>	<b>YT(%)</b>	<b>TW(%)</b>
Volkswagen	100,00	27,08	7,06	3,91
Škoda	3,15	0,75	2,17	0,25
Kia	12,72	1,78	7,45	6,86
Peugeot	37,26	2,24	3,08	4,45
Citroen	31,49	1,54	1,11	3,60
Hyundai	13,98	3,15	9,15	2,03
Opel	12,19	1,16	2,21	3,04
Suzuki	0,51	0,00	2,14	0,00
Dacia	11,55	0,01	0,40	0,35
Mercedes Benz	61,98	93,56	46,05	100,00
Toyota	21,88	6,08	15,26	22,49
BMW	59,86	100,00	43,66	55,32
Renault	55,96	0,72	3,00	3,91
Ford	46,52	17,88	100,00	34,69
Mazda	1,31	0,00	2,97	9,87
Audi	33,20	2,37	28,67	59,17
Nissan	63,35	19,25	3,51	22,20
Fiat	11,76	1,69	2,06	4,95
Seat	16,50	0,41	1,08	0,56
Honda	14,58	16,92	19,69	28,96
Mitsubishi	3,03	0,96	0,64	7,54

Tab. 10 – Online reputation of brands for Slovak environment quantified as relative score. Source: own research

<b>Brand</b>	<b>FB(%)</b>	<b>IN(%)</b>	<b>YT(%)</b>	<b>TW(%)</b>
Volkswagen	69,36	79,06	73,54	0,00
Škoda	45,30	60,65	83,79	0,00
Kia	36,52	19,66	56,73	24,72
Peugeot	24,79	29,80	36,12	0,00
Citroen	26,64	47,15	4,60	2,43
Hyundai	47,01	28,62	25,47	0,00
Opel	11,44	2,49	2,30	0,00
Suzuki	3,92	7,86	4,63	0,63
Dacia	12,59	10,99	11,75	0,00
Mercedes Benz	33,27	63,00	12,18	56,40
Toyota	18,26	3,06	9,28	0,00
BMW	100,00	80,88	95,85	100,00
Renault	25,10	14,83	21,52	0,00
Ford	9,70	32,59	100,00	0,00
Mazda	8,91	31,06	11,98	0,00
Audi	38,75	100,00	49,29	5,50
Nissan	15,55	2,22	32,88	15,09
Fiat	22,73	3,56	8,60	22,48
Seat	13,26	20,98	33,25	0,00
Honda	4,09	0,00	10,19	0,00
Mitsubishi	4,02	13,45	11,70	0,92

In Tab. 9 and Tab. 10, all data are unified and the level of online reputation of car brands is expressed as a relative score in %. Tab. 9 captures results from global digital environment while Tab. 10 contains score calculated for specifications of Slovak digital environment.

All data considered, we can state that German car brands Mercedes Benz, Audi, BMW or even Volkswagen have achieved the most consistent results across analysed rankings. Their strategy of marketing communication in digital world is balanced on all social media both in global and Slovak environment. It can be stated, that these companies understand the importance of proactive approach to digital technologies, and they take steps to build and maintain high level of online reputation in social media.



On the contrary, car brands like Dacia, Suzuki, Mazda or Mitsubishi represent total opposite, as they repeatedly appear on the lowest places of data tables. Especially these companies should concentrate about social media communication in order to get wider audience and become more visible in online environment in their efforts to fortify online reputation.

## 5 CONCLUSION

The paper completes data related to online reputation of car brands from the environment of most important social media. Even though all analysed brands are among globally known companies, the results of research proved there are big differences between them in terms of their social media activities. According to research results, some companies are very strong in social media communication which also positively influence their level of online reputation. On the other hand, there are still car brands which tend to neglect the online communication and thus their online reputation is impacted negatively.

This paper points out that even large global brands still have a lot of room to enhance their communication in digital environment. Improvement in this area can companies help to build their online reputation, and more importantly, it can finally lead to better corporate performance and stronger financial results.

A proactive approach to online reputation management with the use of social media can have a long-term positive impact on corporate performance. The active use of online social media allows businesses to be more flexible to customer requests and react quickly to their feedback. Social media also provide platform for efficient communication with the public or other interest groups of the company. However, many companies do not exploit full potential of social media, depriving them of possible competitive advantage and improved business results.

### Acknowledgement

This work is one of the partial outputs of the research grant VEGA no. 1/0876/17 entitled “Research of cognitive and behavioural determinants of products innovation diffusion across European markets”, led by Ing. Bc. Peter Štetka. PhD., University of Economics in Bratislava, Faculty of Business Management, Department of Business Economy.

### References

- Burke, J. et al., (2011). *Corporate reputation: Managing opportunities and threats*. UK: Gower.
- Doorley, J., & Garcia, H. F. (2007). *Reputation Management*. New York: Taylor & Francis.
- Dorčák, P., Pollák, F., Mudrik, M., & Nastisin, L. (2014). Slovak virtual market in the light of analysis of possibilities of detecting on-line reputation for selected subjects. *Komunikacie*, 16(4), 128-132. Retrieved from [komunikacie.uniza.sk/index.php/communications/article/view/589](http://komunikacie.uniza.sk/index.php/communications/article/view/589)
- Dorčák, P., & Pollák, F. (2013). *Analýza on-line prostredia slovenského virtuálneho trhu 2013*. Retrieved from [www.region-bsk.sk/SCRIPT/ViewFile.aspx?docid=10051170](http://www.region-bsk.sk/SCRIPT/ViewFile.aspx?docid=10051170)
- Gottschalk, P. (2011). *Corporate social responsibility, governance and corporate reputation*. USA: World Scientific Publishing.



- Hung, Y. et al. (2012). Online reputation management for improving marketing by using a hybrid MCDM model. *Knowledge-Based Systems*, 35(1), 87-93. doi: 10.1016/j.knosys.2012.03.004
- Hojdik, V., & Majtán, Š. (2017). Online reputation management as an integral part of company business management. Paper presented at International Scientific Conference of Business Economics, Management and Marketing, Zaječí, Czech Republic, 76-83. Retrieved from <https://is.muni.cz/repo/1389403/Proceedings.html>
- Hojdik, V., & Majtán, Š. (2018). Online Reputation Management as an Opportunity For Business Performance Improvement. *Aktuálne problémy podnikovej sféry 2018*. 433-442. Retrieved from <https://appsconf.wordpress.com/zborniky/>
- Micháleková, J., Šulik, M., & Sasko, J. (2016). *Sprievodca online reputačným manažmentom*. Visibility.
- Pollák, F. (2015). *On-line reputačný manažment v podmienkach stredoeurópskeho virtuálneho trhu*. Prešov: Bookman.
- Roháľ, R., & Sasko, J. (2011). *Analýza sentimentu výsledkov slovenských firiem*. Retrieved from [reputation.sk/wp-content/uploads/2014/01/Analyza\\_sentimentu\\_reputation\\_sk.pdf](http://www.reputation.sk/wp-content/uploads/2014/01/Analyza_sentimentu_reputation_sk.pdf)
- Sasko, J. (2011). *Spravodajské portály ako riziko pre reputačný manažment*. Retrieved from <http://www.reputation.sk/spravodajske-portaly-ako-riziko-pre-reputacny-manazment/>
- Sasko, J. (2014). *Dbáte na hodnotu svojej značky?* Retrieved from <https://www.podnikajte.sk/manazment-marketing/c/1392/category/marketing/article/online-reputacny-manazment.xhtml>
- Walter, E. (2013). *10 Tips for Reputation and Crisis Management in The Digital World*. Retrieved from [https://www.forbes.com/home\\_usa/?toURL=https://www.forbes.com/sites/ekaterinawalter/2013/11/12/10-tips-for-reputation-and-crisis-management-in-the-digital-world/](https://www.forbes.com/home_usa/?toURL=https://www.forbes.com/sites/ekaterinawalter/2013/11/12/10-tips-for-reputation-and-crisis-management-in-the-digital-world/)

## Contact information

### Ing. Vladimír Hojdik, PhD.

University of Economics in Bratislava, Faculty of Business Management

Dolnozemska cesta 1, 852 35 Bratislava

E-mail: [vladimir.hojdik@euba.sk](mailto:vladimir.hojdik@euba.sk)

ORCID: 0000-0001-6955-1677

doi: 10.7441/dokbat.2019.036

# A START-UP – WHAT REALLY MATTERS AT FIRST

*Jana Hubinová Skubeňová*

## **Abstract**

This paper deals with basic presumptions about start-ups. In fact, new businesses do not any longer present themselves as a business but as a start-up; especially if they throw the ball into undiscovered field or/and they come up with new, creative and innovative solutions how to simplify people's lives. As we reflect on our contemporaneity, being innovative has become a standard in business societies that we often blame of consumerism. The truth is that start-ups have, just like any other business, two faces: the one related to trade and the other related to their cause. In our paper, we explain basic differences in between a start-up and a business and continuously try to dig a little deeper into stereotypes very often linked to start-up launch on the market. In the end, we explain our stand-point related to start-ups research we are continuously running and what does really matter at the very first stages of start-ups' existence.

*Keywords: business, digital platform, entrepreneurship, good cause, investor, start-up*

## **1 INTRODUCTION**

For general public, common people in the crowd, it may eventually be quite difficult to understand what does a start-up mean. People usually use the term interchangeably with the notion business. So what is the difference in between the two, anyway? Are the notions interchangeable or is one an umbrella term for the other one? Why do we mix them up so often?

## **2 A BUSINESS OR A STARTUP**

Let's start with the characteristics a business and a start-up have in common. A business as well as a start-up can exist both, as a profit and non-profit entity. Businesses and start-ups where profit is the main cause have profit and moneymaking as one of their main aims. Non-profit organizations and companies, on the other hand, do not put profit at first positions of their target list however making-money or saving-money usually is one of their causes. This may sound quite incomprehensible and for the case, examples should be given. (Hayes, 2019)

Moneymaking is a big challenge for most of the charities who are non-profit businesses and as such raise money for some good cause. Their mission is charitable. In case of money-saving businesses and start-ups, social cause is usually very much present in their mission as well as their company's vision. (Hayes, 2019)

Taking it solely from the semantic perspective, the term start-up (written also as start-up) has already settled well in English language dictionary. Its semantic meaning comes from the parts of compound, describing something that has just started and is on its way up.

Merriam-Webster's dictionary (2019) describes start-up as 'a fledgling business enterprise'. The important part of the description is the word fledgling (adjective) that is usually used as some sort of diminutive, to soften or subtilize the subject. Cambridge dictionary (2019) explains the noun fledgling as 'a young bird that has grown feathers and is learning to fly'. Start-ups are meant to grow, evolve, to be developed. However, this is the case with long functioning business, too. (Robehmed, 2013)

Having outlined what a start-up actually is, the difference between launching a start-up and running a business starts to emerge. There is no doubt that start-up is all about growth. Growth of the company, growth of individuals working within it, use of new ideas supported by new technologies... Certain start-up founders who became tycoons in their field perceive start-ups with a slightly shifted perspective. One of them is Neil Blumenthan, cofounder and co-CEO of Warby Parker who defines a start-up as '... a company working to solve a problem where the solution is not obvious and success is not guaranteed'. (Robehmed, 2013)

Compared to the neologism start-up, business is a term commonly used in and for many fields of human activities. Speaking about its economic potential, a business is a commercial, mercantile or industrial activity that is usually meant as a means of livelihood. The term business is therefore used for both, an activity of organization and entrepreneurship of an individual. What makes a real and nearly touchable difference in between the two terms is the factor of innovation. A start-up needs to bring something innovative compared to a business that can be an engagement in the field that is already in place and ideally, the demand is higher than the actual offer. New businesses often take advantage of their competitors avoiding mistakes they have made and grab the opportunity to make things better. At this point, a business could possibly become a start-up once the approach to business is ahead the competitors'. It usually requires a great idea to run a start-up. (Hayes, 2019)

## **2.1 Popular successful and failed start-ups**

One of the most common causes why some businesses in Slovakia did not make it through 1990s was that the set of political, social and bureaucracy situation in Slovak republic changed. Zednik (2012) suggests that the society reacts to such a change by progressive change in tendencies that lead to over-all adaptation of the society to new circumstances. Some businesses understood the dogma and those businesses survived the turbulent era. They changed the suppliers, start to use innovative materials, enhanced their services, though the other businesses who stick to their long-term heading with no shift in the direction ended.

One of the primary reasons why we have launched our global research (starting in the EU) is that we believe in high potential of domestic self-employment as well as small business companies capabilities for GDP growth.

In the course of 2018, we have set up a team of co-workers and data miners who were asked to have a closer look at some outstanding start-ups (especially US ones), trying to find the links in between the successful as well as unsuccessful ones. The choice of start-ups was conditioned by 3 basic criteria given conditions of 'start-up and its specifics in individual countries' pre-launch project of Scientific Grant Agency VEGA as a part of the Ministry of Education, Science, Research and Sport of the Slovak Republic.

The first one was that the chosen start-up must have had a clear and traceable funding from the very beginning. There should have been no doubts to whatever stage of start-up evolution where did the money come from and how the funds were collected. Transparent and traceable funding is legal requirement and an absolute must for newly launched companies, especially in case of crowdfunded start-ups. Transparency stands for traceability, in other words, funding must be exposed to public. Information have to be fully and freely accessible. (Nielsen, 2017)

The second one was that the start-up must have been referenced in local and/or nation-wide media as something outstanding at least by 5 different, relevant sources. The term outstanding is used in this article only, as in our original research, we used a list of keywords in English language (put together by a SEO specialist) that was translated into several languages and will be used ongoing in our further research. The relevance of sources was judged based on their credibility and readability according to CREDBANK corpus criteria (Mitra & Gilbert, 2015).

The criterion was referenced to add up on emotional value and content aspect of chosen start-ups. Awareness spreads faster if a reference is provided in media. Popularity is at its first stage matter of awareness and then likeness.

The last criterion we set up was topicality. Each start-up referred to in our pre-launch research must have been settled for the purpose of some so-called 'good cause'. As the notion itself is used as an umbrella term, we work with it in scope of social entrepreneurship. The reason why we limited our research to socially responsible companies only is quite simple. We, the scholars, want to raise awareness especially of those businesses that add some extra value worth spreading. At the same time, goodwill of the company is an immensely important attribute contributing to start-up success/ fail.

We divided researched companies into three basic groups according to Bassell (2007). Here we give examples of start-ups representing each group.

### **Small, 'happen-to-be' start-ups**

A great example of a good cause start-up, directly from Slovakia, is the project KOLOKOLO that was founded by FMK (Faculty of MassMedia Communication at University of Ss Cyril and Methodius in Trnava, Slovakia) students. The students initialized a collection of old or non-functioning bicycles in Trnava town and after having them collected, they repaired and renewed the bikes and these are currently offered for rent as an ecological alternative for short-distance commuting. The bicycles are green which symbolizes eco aspect of the project and even though they were primarily meant for Trnava students, nowadays anybody can rent one for a symbolic price from 10 to 30 Euro for up to 10 months. The project is definitely non-profitable taking into consideration the amortization of the bikes, their technical maintenance, few cases of stolen bikes that needed to be replaced and the fact that the citizens community KOLOKOLO used the money from rents to build bicycle parking bays around the town of Trnava to increase the comfort of bike users. The bicycle bays were built especially in the university campus and in the town centre to satisfy needs of their clients and for safe bike parking. Socially responsible approach of the project KOLOKOLO along with its eco-friendly dimension leaves a clear message in Trnava citizens' conscience; it is extremely important to find simple solutions for everyday complications of local people, especially of the young ones. At the same time it leaves us with hope that socially responsible conduct can be taught. This type of start-ups rarely lasts for long enough; its existence is rather a matter of trend. They are referred to as lifestyle companies.

### **On demand companies**

The second group is represented by companies that sell some service on demand. In this group, there are incorporated companies meant to elevate living standard and/ or simplify our lives. The companies make one's existence less complicated, more comfortable and less time consuming. These start-ups incorporate social aspect and commercialize the service into moneymaking. A great example of such a company is Homejoy. Homejoy is a company offering cleaning services via online booking. The advantage of Homejoy, compared to other cleaning service companies, was that they offered a low-cost service to be booked from the comfort of one's sofa with no need to call the service company. Homejoy's cleaners should have been scanned. The company was a massive success back in 2013 when siblings Adora and Aaron Cheung founded the company. They even hit the list of The Hottest start-ups of 2013 compiled by Forbes- online magazine- as the fastest growing business in that year. When asked about a start-up back then, Adora Cheung, the co-CEO of Homejoy proclaimed that she perceived a start-up as 'a state of mind' rather than a business or entrepreneurship. Especially from the point of view of start-up employees. 'It's when people join your company and are still

making the explicit decision to forgo stability in exchange for the promise of tremendous growth and the excitement of making immediate impact.’ (Robehmed, 2013)

### **World changing ventures**

The last group are ‘gazelles’. A gazelle is a start-up thriving for better future. In the first group, there are the companies that are socially responsible and thrive for our better future. A great example of those is Warby Parker, a tremendously successful designer eyewear company who followed the path of other socially responsible companies such as TOMS or Thrives Market (eco-friendly online supermarket). What clearly makes them a start-up company and not a common business launch is not only their eco-friendliness (they are the only carbon-neutral eyewear company), but mostly their equity (they guarantee low prices for quality eyewear as one of primary reasons of their existence). At the same time, they became a part of 'buy one, give one' movement which means once a customer purchases any glasses, the company donates a pair of glasses for the ones in need. Warby Parker companies do not sell goods, only. Their services are above standard and more over, a product bought is sold to their client along with better conscience. After having collected data from the researchers and suggestions on what the common factors for start-up success or fail really are, here we present a review outlining our individual findings.

## **3 TOP THREE OF WHAT MATTERS**

Being successful in business means to do something tremendously well. Proficiency in business area is necessary. Not always, but most of the time it is the key factor of flourishing on the market. Then, there are other variables. These variables may predestine a start-up to become a successful business or even a venture. In our primary research, we have considered a list of 14 criteria. Among these, there were action plan, ideas, methods, money and others. After having reviewed 76 start-ups from the EU and Russia, we put together with our researchers the following factors influencing success. For the purpose of this article, we picked up top three ones that achieved the highest score (these were present in the list of the most influential factors in re-researched start-ups). The order is alphabetical.

### **3.1 Geographical extent**

Globality vs. locality. A thrive one needs to understand to be able to accommodate to their business needs wisely. First, there are two trends, both very strong and those, who took one or the other path, have very strong reasons to do so. To choose the right geographical extent for a start-up is a vital thing. In fact, ambitions of a business influence the decision a lot, of course. Not being blindfolded by one’s ambitions and facing the challenges with a reasonable approach is an advantage. Speaking about the differences, there are generally three types of businesses based on sales area.

Local business is very easily recognizable. It is a business that sells its products and services to consumers in its own city, town, or geographic area (Fletcher & Lyon, 2016). Owners of local businesses are limited by regional and national legal acts and are usually in good contact with their customers, as well as suppliers. Local businesses do not necessarily have to be businesses of small-scale, though, they usually are. They are mostly limited by finances and personnel. Once there is a stable clientele, the product/service is repetitively sold to clients and functions on their loyalty. They cannot compete much with global companies, especially not in price, though, they take exceptional care of relations they create and build up a stable basis of customers. They focus on CRM and they tend to have individual needs fulfilment approach. Community service is the key notion. Extra advantages for a few long-term customers are possible; however, no big discounts or exceptional price lists should be expected. Community

culture is highly respected, habits are held and expectations are met on a high level. Local business of a small-scale is e.g. a nail design shop, home-grown vegetables grocery shop or a language school. A great example of a locally successful language school is Wings, a language school operating in the Galanta region, precisely the town of Sered'. Its revenue depends directly on two factors, the number of personnel and the number of clients. It offers lessons to their individual clients and company clients in the town. Knowing the company's culture enables them to suit their clients' needs the best possible way. The school focuses on each individual client (whether a person or a company) and they excel in a friendly, family-like approach.

A type of business that has all previously mentioned features but is no longer a local business due to their geographical extent growth is regional business. In respect to business, regional means pertaining to a small geographical area (Fletcher & Lyon, 2016). Such type of businesses usually offer their products and/or services at various sites, given their internal and external structure. Regional business is oriented on the whole region and ideally, does not have much competition within the same region. Any well-settled competition to newly launched start-up is a great disadvantage and may (usually does) result in bad success. As an example of the luckier case may serve us Natur House that was established in Spain by an economist Félix Revuelta who had decades of experience in pharmaceutical (basically nutrition oriented) business. The company raised its start-up flag with an innovative approach to nutrition and weight-controlling in 1986 and soon became a flourishing regional business. More than a decade later, in 2000, the company board decided to take the flourishing business overboard and now they run around 2400 establishments worldwide, in Spain, Slovakia and other 31 countries.

Speaking about development of Natur House, for example, a successful regional business may make effort to become a national business. In most countries, where there is no civil war, no racial, nationality or sex hatred that are likely to cause a country's disintegration, a regional business may easily become a nation-wide one. The same rules apply, districts within the same country rarely differ in legislative regulations and enlarging a regional business is usually easier than running a completely new start-up. Expanding area means expanding personnel, number of sites and sometimes strengthening marketing activities; apart from that, the concept of a business remains the same. National business is the one that operates on national market, which means the domestic marketplace for goods and services operating within the borders of and governed by the regulations of a particular country (Fletcher & Lyon, 2016).

The highest potential revenue comes from large global business or global networks. As per rule, it comprises of high amounts of employees, big capital and great time and effort lies in management. It means that managing a worldwide enterprise or corporation is the most difficult and the most profitable business out of all. Speaking about start-ups, nowadays, when a great number of them come from and function in the internet environment, huge investments of money tend to be surmountable. This is often not the case as poor software or virtual world start-ups tend to raise and fall with no significant success and little time lapse in between the two stages. Visibly, an international business does not limit to country borders but consists of business transactions between parties from more than one country (Fletcher & Lyon, 2016). The important message in the definition lies in transactions being made cross-border. In fact, thanks to global outlook on international business and its policies worldwide, there exist a few concepts how to run an international business. The most common approach is to expand foreign markets with already profitable pack of services or products that are well-settled on the national market. A completely different concept is to create such an innovative idea (product or service) that it requires to be protected by a patent. Licensing a patent requires money, especially licensing it globally. In fact, few companies succeed to invent something new but those who do win a lottery. Public know the most influential companies that started certain revolutions-technological (Microsoft, Apple), communication (Facebook, Instagram, Viber), etc. Their

investors are billionaires now, their CEOs became tycoons. Business world is run by them. However, they face a new challenge, too. The biggest challenge of a successful international start-up is its sustainability and the guts of the Board of Directors in regards not to sleep on new opportunities for investments, innovations and further business expansions.

So to say, there are various approaches to entering foreign markets to become an international business. The most common ones are exporting (the easiest way how to enter a foreign market by producing goods on home market but selling it on the foreign market), licensing (usage of intellectual property of one entity by another entity in a different country), franchising (usage of name of a parent company by a different company cross-border), joint venture (mutual agreement of collective ownership of a company on global level) or IBC (International Business Corporation- 'an offshore company that is generally exempt from all types of taxes, and mostly used for investment and is a vehicle for international commerce'). (Projects4MBA, 2020)

The geographical factor and the right choice of start-up geographical extent may determine the size of the business from the beginning. May one want to settle a highly profitable business, depending on the geographical scale the business is limited to, the company may be profitable. Simply said, less profit comes from smaller area as there are fewer potential customers compared with a waster area where a business operates and there are more potential customers. As found in researched start-ups, it is better to focus on wide scale of potential customers in vast territories rather than to focus on local market with very limited being force. In addition, in regards to tycoons... Tycoons are born into families with global thinking and are raised by international tutors. Also proven by history. (Robehmed, 2013; Fletcher & Lyon, 2016)

### **3.2 A good cause**

A good cause is an idiom used in various contexts. Its meaning varies based on context in which the term is used. Some business literature uses the term to describe non-profit organizations, so-called charities. In our paper, we understand a good cause to be a worthy cause (Janáková, 2015). We work with the notion having in mind the following; having a good cause stands for having a clear, unmistakable vision why you start a business. It is the vision that the founder envisages while working on the project. The cause may relate to any area of human activity where the change is needed and a problem should be solved. Nowadays, when our planet faces inevitable species extinction, carbon gases pollution and many more environment related threads, which have massive impact on all of us, some start-ups tend to search for solutions related to no-waste, eco-friendly, bio branches of business. There also are many start-ups that try to propose new technological solutions to simplify our lives- both in artificial intelligence direction or/ and robotics. There is quite a balance in between innovative and back-to-roots related business that are founded and they usually enter the market as growing start-up companies.

Getting back to good cause, ideally, it should be nothing profit-related because people burn out easily (as well as finances do). From conversations with a few owners of quite recent start-ups (sli.do, eyerim, Martinus) we acknowledged that they consider a good cause to be the driving force, the unstoppable engine, the one reason to overcome eventual issues that do usually appear at the beginning. As many failed start-ups have proven, it is easier to replace personnel if a good company vision is proposed compared to the opposite case.

Another thing, inevitably linked to any good cause is the possibility of sponsorship. Many start-ups as already mentioned tend to search for sponsors. Those, on the other hand, do not usually have to look up for start-up investments, though, they are 'attacked' by numerous founders, researchers and CEOs and asked for financial support because of their 'good cause'. The purpose of the business along with realistic evaluation of its possible success are the two main

reason why most sponsors consider investments into start-ups. The key factor of a start-up is to be recognizable.

Sometimes, the good cause comes later on, when the business is already well settled on the market, profitable and recognized. Other times, it comes retrospectively and a business strengthens its position on the market, in the community or its goodwill by making their product or service extra in certain way. It can be an innovative eco-friendly production that they may introduce into their business or waste management with zero waste orientation. Either way, innovation and keeping up the pace with trends makes any start-up a clearly recognizable company if supported by good marketing.

Looking for sponsorship may usually be worthy especially in cases of start-ups that want to invest in great, transformative ideas. The simple truth applies here; who wants to buy a new pair of shoes if they are very much alike the previous one. Especially in short term. A great example that comes in use is the one of popular start-ups related quote that says: 'Fake it 'till you make it.' In fact, many social psychologists consider this quote a modus operandi of Silicon Valley, the most potential cradle of start-ups in the world, for years now. The Independent, one of opinion-forming online newspapers in the UK claimed that this approach is toxic and results from the whole culture wrapped around the notion. As a result of such claims, let us remind new start-up founders 'think twice, cut once' in regards to their cause propaganda.

Not long ago, in September 2018, Theranos, a health corporation co-founded by Elizabeth Holmes became a great example of 'fake it till you can't manage it' when the company shut down their laboratory and along with it a few corporate sites as they could not prove any of their research to be true. (Cardenas, 2019)

Daniel Ariely, a recognized behavioural expert stated in regards to Theranos unthinkably and unbelievably high financial stimulus received from sponsors, the following: 'The reality is that data just doesn't sit in our minds as much as stories do. Stories have emotions that data does not. And emotions get people to do all kinds of things, good and bad.' In fact he acknowledged one of the marketing mantras that telling a story (a cause) about what You do is a way more powerful message than giving data on how successful your product or service is going to be. (Cardenas, 2019)

It is tremendously important to come either with an icebreaker (in regards to new ideas and technologies) or with an idea worth spreading. More than 87% of researched start-ups brought up something new that was meant to simplify, facilitate or make our living more effective. To sum it up, social, environmental, education, technological or sustainability related changes are good causes a start-up shall ideally foster to envision its future success. One should keep it in mind while establishing a start-up.

### **3.3 Money**

Taking into consideration that the most successful start-ups do often come from fledgling entrepreneurs, it may seem that money is not an important factor. However, it actually is the other way round. Emerging start-ups do not require any cash at the stage of being ideas, dreams, visions... Then, an idea needs to profile into a running business. At this stage, the creator of the idea becomes its performer. Usually, a team is created and a business plan associated with the idea is introduced to all people involved. Various levels of secrecy are applied in communication with various individuals and/or companies. In pursue of a running well-off start-up, the creator who has become a performer, very quickly shifts their role to a role of an executioner, an achiever. Now, there is the time to speak about finances...



Based on legal requirements of the country where the business starts its existence, a business structure has to be decided upon. The very first question asked is whether the proprietor should stay a self-employed professional or they want to operate a business. Do they want to create a limited liability company (LLC)? Does the inventor have enough capital to be a sole proprietor of the start-up? They usually do not. As such, start-ups are often partnerships of individuals and/ or partnerships with corporations. What has a tremendous impact on the business structure are the ambitions of the owners. In addition, as already mentioned, the available capital of money to be spent. Premises, personal, technologies; it costs quite an amount of money and the capital flow needs to be ensured throughout all the time.

In case of successful start-ups, the business structure changes swiftly and a simple partnership may develop into a flourishing LLC or corporation itself. The business size and the region they operate in (company's geographical impact) affects these decisions a lot. From a small, owner-operated company of innovative ideas or a flourishing family business into an international conglomerate. Such dreams do not happen often, though, they sometimes do as great examples of outstanding start-ups.

For starting the most common form of a business, a partnership, one should know the following golden economic/ tax rule. A partnership is a business relationship between two or more people who join to conduct business. Each partner contributes resources and money to the business and shares in the profits and losses of the business. The shared profits and losses are recorded on each partner's tax return. Similarly, it works for corporations and international conglomerates.

Once the money talks keep on intensifying their periodicity in business and keep on growing in the sums needed to operate a business, a start-up is in the right time for so-called stretch. The term comes from Paul Graham, a head of Y Combinator, an entrepreneur and venture capitalist. He co-founded the start-up accelerator '... because it seems such a great hack. There are thousands of smart people who could start companies and don't, and with a relatively small amount of force applied at just the right place, we can spring on the world a stream of new start-ups that might otherwise not have existed.' (Graham, 2006) 'Small amount of force', speaks for itself; mostly capital and know-how (experience in business making). He used the term stretch to describe a company that strives to settle on a market for quite longer period of time (such as 10 years) and even though it is not a brand new enterprise, it still may be perceived as a start-up; a start-up company in need of investment.

Investors are those people who facilitate start-up flourishing in short period of time as they have both, some free capital and know-how from other business experience. Overall, general public perception of an investor as a person who is interested in achieving profit from their free financial resources by investment into a business, for example, is quite inaccurate. The truthful part is the one about an investor expecting to achieve something in return; however, the profit may have in numerous forms. Investments from investors are usually in form of money or/ and premises, staff, supporting services, etc.

There are all variables of investors. A few examples of the most common start-up investors follow:

**Family and acquaintances** (they do not expect much in return. Their investments usually depend on their own free will to invest in one's company and lead to low or no profit. These are based on mutual trust. Nevertheless, such loans are legally binding, too.).

**Accredited investor** (the term is used primarily in the US legal and business system as such investments are coordinated by the government and SEC (The Securities and Exchange

Commission). The US system prevents individuals, the investors, from accidental bankruptcy by setting the rules proving that one can afford to risk their money in a start-up.

**Angel investors** (the term angel investor, also referred to as informal investors or angel funders, stands for a whole bunch of things. From experience, these investors put their money into a business at the very early stage of its existence with no guarantees of any positive financial outcomes. These investments are very risky and only rarely, any visible, touchable and reasonable outcomes can be expected within a short period of time since investment. However, there are certain exceptions such as tremendous success of Instagram, for example. On the other hand, one has to admit, Instagram was not a solitaire at the time it was invented on the field of social networks. Still, it is incredibly successful in the gap on the networking market; people became more visual and less written-content-orientated. At the time of its invention, Facebook did not catch up on the fact that every human being of our era having access to the Internet and existing on any networking platform wanted to share but in as little time as possible with the biggest possible impact on their audience. Sharing primarily visual and audio-visual material was the clue. It actually still is.

Financing a project is a whole science on its own. May we have an opportunity to give a single rule for financing a start-up at its very early stage; do not work on the business plan, solely. Building up a solid financial plan ahead is comparably important. In addition, in the end, it protects your own private money from making foolish, accessible investments blindfolded by your own ambitions about a thriving business.

Investigating 78 start-ups, money (sufficient financing) has proven to be a common factor that all researched start-ups have been dealing with at the early stages of its existence. Primarily, it was in regards to administration (bureaucracy) fees related to a start-up launch from legal point of view. At both, national and federal level, legislation conditions start-ups to be legal entities with certain level of liability. Legal business requires legal settlements.

## 4 CONCLUSION

The Earth is supposed to be more than 4.5 billion years old. Just centuries ago, the wheel did not exist. Its development went through various stages. At one specific stage, the wheel already existed (a pottery wheel) but the system of wheels for transportation (consisting of a round with a hole in its middle and an axle) was not yet figured out. And yet, the wheel as we know it, a perfectly round shape used on a bicycle or for cars, is now an inevitable part of our everyday lives.

The same way it is with start-ups. Once unbelievable, impossible or improbable inventions come into life on daily basis. Discoveries are found. Charles H. Duell is known for his quote: 'Everything that can be invented has been invented.' The fact is that there always is something new that can be brought to existence. Improved. Simplified. Magnified... Start-ups are businesses that usually start with people envisioning their better lives. Everybody's better life. At first, they are viewed as dreams and subsequently, these dreams develop into projects. The extent of the project depends on various factors among which the most important ones are ambitions of the idea owners, their self-confidence and, of course, funding, so that finances. Usual start-up is a small entrepreneurship vision and it seeks its mission in the wide world. Once searched well and the correct plans are followed, the correct strategies are applied, a start-up may become a successful business.

In our research, we work with various European Union countries, such as Latvia, Germany, Spain, Netherlands, etc. At first stage of our research, after having run the scan and agreed on common conditions, our researchers in various countries picked up various start-ups from

different backgrounds- technological, art, service and product start-ups. As this scanning phase proved, there are three main factors having extremely important influence on start-ups success. The first one is money. A start-up cannot be run with no finances to back it up. From re-researched start-ups experience woman claim that the most of the capital comes from so-called 'angels' and start-up initiators family members (depending on the size of the business run). The second is the cause that can attract potential clients. This is applicable especially in case of start-ups providing products. Product portfolio can be both limited and wide but only occasion-ally there appears a new product. For such a reason the products demand not only the product itself but also an extra service supporting product's sale. The good cause and its importance starts to emerge here. The last of top three list is the decision that needs to be taken at the level of start-up extent. Ideally, this decision should be taken at the very first stages or even before the start-up is launched. All further steps in regards to marketing, logistics and provisions need to be directed in chosen way. The sooner the decision of expansion is made the better the preparation and direction of the start-up owners efforts are.

What really matters these days, especially in case of new business launch, is envisioning. As William Arthur Ward has once wisely proclaimed: 'If you can imagine it, you can achieve it. If you can dream it, you can become it.' A viewpoint worth following. The fact is that no matter how much money is spend, how much time is wasted, a start-up is a lesson learnt and experience gained.

## References

- Bassell, M. (2007). *Entrepreneurship: Types of start-ups*. Retrieved from [http://userhome.brooklyn.cuny.edu/bassell/entrepreneurship/images/Myles\\_Bassell\\_505SGS1.pdf](http://userhome.brooklyn.cuny.edu/bassell/entrepreneurship/images/Myles_Bassell_505SGS1.pdf)
- Cambridge dictionary. (2019). *Fledgling: Meaning of fledgling in English*. Retrieved from <https://dictionary.cambridge.org/dictionary/english/fledgling>
- Cardenas, B. (2019). *Theranos founder Elizabeth Holmes succeeded because of toxic millennial 'fake it til you make it' culture*. Retrieved from <https://www.independent.co.uk/voices/theranos-elizabeth-holmes-scam-silicon-valley-a8835886.html>
- Fletcher, A., & Lyon, B. (2016). *Geographic Market Definition in European Commission Merger Control*. Retrieved from [https://ec.europa.eu/competition/publications/reports/study\\_gmd.pdf](https://ec.europa.eu/competition/publications/reports/study_gmd.pdf)
- Graham, P. (2006). *Why YC*. Retrieved from <http://www.paulgraham.com/whyyc.html>
- Hayes, A. (2019). *Business: What is a business*. Retrieved from <https://www.investopedia.com/terms/b/business.asp>
- Janáková, H. (2015). The Success Prediction of the Technological Start-up Projects in Slovak Conditions. *Procedia Economics and Finance*, 34, 73-80. doi: 10.1016/S2212-5671(15)01603-2.
- Merriam-Webster. (2019). *Start-up: Meaning of start-up in English*. Retrieved from <https://www.merriam-webster.com/dictionary/start-up>
- Mitra, T., & Gilbert, E. (2015). *CREDBANK: A Large-Scale Social Media Corpus with Associated Credibility Annotations*. Paper presented at the Ninth International AAAI Confer-ence on Web and Social Media, Oxford, England. Oxford: Retrieved from

- Oxford University. Retrieved from <https://www.aaai.org/ocs/index.php/ICWSM/ICWSM15/paper/viewPaper/10582>
- Nielsen. (2017). *It's clear: Transparency is winning the U.S. retail market*. Retrieved from <https://www.nielsen.com/us/en/insights/report/2017/transparency-is-winning-the-us-retail-market/>
- Projects4MBA. (2020). *Types of International Business*. Retrieved from <https://www.projects4mba.com/types-of-international-business/137/>
- Robehmed, N. (2013). *What is a startup*. Retrieved from <https://www.forbes.com/sites/natalierobehmed/2013/12/16/what-is-a-startup/#4b78b4ce4044>
- Zednik, R. (2012). *A Country Lost, Then Found: Discovering My Father's Slovakia*. Scotts Valley, California: CreateSpace.

### Contact information

#### **Mgr. Jana Hubinová, PhD.**

University of Ss. Cyril and Methodius in Trnava, Faculty of MassMedia Communication  
Nám. J. Herdu 2, 91701, Trnava, Slovak Republic  
E-mail: [jana.hubinova@gmail.com](mailto:jana.hubinova@gmail.com)  
ORCID: 0000-0002-9456-7803

doi: 10.7441/dokbat.2019.037

# EXPLORING THE ROLE OF DESTINATION IMAGE TO ECOTOURISM INTENTION

*Vo Viet Hung, Zuzana Tuckova, Hung Cuong Hoang*

## **Abstract**

The destination image is a concept created by different supply and demand agents. The balance between what is expected and what is being offered is essential in promoting the destination. Tourism is a social phenomenon based on a positive destination image. The target image is the mental expression held by the individual of the venue, and the delay depends on the information received or the actual visit by the individual. However, tourism research has yet to confirm whether an integrated destination image models applicable in predicting the overall destination image and behavioural of travellers. The purpose of this study is to delineate those criteria by analysing the correlation between destination personality, destination image, and intention to visit while considering the influence of constructive attitudes and emotional values.

*Keywords: destination image, destination personality, ecotourism, behavioural intention*

## **1 INTRODUCTION**

Tourism to natural areas has been widely endorsed as a mechanism for sustainable development and for providing financial incentives to protect natural areas from alternative economic transformation (Kazeminia, Hultman, & Mostaghel, 2016). Tourism has been seen as the driving force for regional development. Successful tourism can increase destination's tourist receipts, income, employment, and government revenues. How to attract tourists to visit and/or recommend the destination to others is crucial for the success of destination tourism development.

Ecotourism or nature tourism is acclaimed as the fastest-growing sector of the international tourist industry. Though used interchangeably, the two terms involve separate and distinct concepts. In order to differentiate the many aspects of nature tourism, a confusing array of terms has been adopted into common usage. To discriminate among these terms is more than a debate of semantic distinction. The terms are not synonymous and the nuances of their separate meanings should be recognized. The notion of ecotourism eludes precise definition because it is a complex concept that ambitiously attempts to simultaneously describe an activity, frame a philosophy, and promote a model for development. From the perspective of the tourist consumption process (Juganaru & Juganaru, 2008), tourist behaviour can be divided into three stages: pre-, during- and post visitation. More specifically, tourist behaviour is an aggregate term, which includes pre-visit decision-making, onsite experience, experience evaluations, and post visits behavioural intentions.

It has been generally accepted in the literature that destination image has an influence on tourist behaviours (Dener, 2011; Lee, 2007). Travel behaviours include selecting a destination to visit and evaluating subsequent and future behavioural intent. Further assessments include travel experience or perceived trip quality during stay, perceived value and overall satisfaction while future behavioural intent includes intention to visit. Based on the knowledge that the target image is an overall impression cognitive and affective evaluations (Chiu, Lee, & Chen, 2014) it is suggested that brand associations should include cognitive and affective image components (Bramwell & Rawding, 1996). These two components are accepted as influential indicators of destination image (Williams & Soutar, 2009).

## 1.1 Research problem

In recent years, the influence of tourism on the environment, economy, and social and cultural fabric of society has become increasingly important. Alternative tourism models, such as nature-based travel, green travel, responsible travel, soft-tourism, cultural tourism, adventure travel, and ecotourism, are widely regarded sectors that are growing more rapidly than general tourism (Gartner, 1989).

Ecotourism, one of the fastest-growing tourism sectors, is defined as traveling to respectively undisturbed natural areas with a specific objective of learning, admiring, and enjoying the scenery and wildlife in the ecosystem, and understanding the history and culture supported by the environment. Ecotourism is also considered as a scientific, aesthetic, or philosophical approach to tourism (Ross & Wall, 1999). It benefits the conservation of natural resources financially, and assist local populations directly in achieving sustainable development of the environment (Dogru & Bulut, 2018; Tsaur, Lin, & Lin, 2006). Ecotourism compared to mass tourism has four principal advantages:

- 1) Less impact on the environment and maintenance of ecosystem stability and diversity;
- 2) Respect for local culture;
- 3) Direct economic benefit for local populations;
- 4) Maximization of recreational satisfaction. (Clarke, 1997; Tribe, 2012)

Thua Thien Hue province is a small but rapidly growing city in central Vietnam, famous as a cultural centre. The development of the province has negative impacts on its environment and natural resource base. In the scenario, tourism plays a key role in the city's socioeconomic. However, the problems for Hue's government are presented in aspect: lack of researches which focuses on tourist behaviour, through the demand of policies follow the feedback from visitors and stakeholders, who is responsible directly from tourism activities.

In its story, ecotourism became evident over this period that demands a particular type of tourism which has shifted away from tourism towards sustainable development in Thua Thien Hue province. When tourists chose destinations, they usually select locations that satisfy the subjective criteria if their requirements. The purpose of this study is to delineate those criteria by analysing the interrelationship among destination personality, destination image and intend to visit while examining the effect of construct attitude, perceived value, and tourist satisfaction.

## 1.2 Research objectives

From problems research, this study focuses on examining ecotourism activities under a visitor perspective. The primary aim of this research was to assess ecotourism behaviour and a view to suggesting strategies that will contribute to local, sustainable tourism. In order to fulfil this research aim, the five objectives were set up as follows:

- a) To measure the impact of Destination Image on ecotourism attitude;
- b) To measure the impact of Destination Image on ecotourism perceived;
- c) To measure the impact of Destination Image on the Destination personality;
- d) To identify the relationship between Destination Image and visit intention of visitors;
- e) To clarify the role of Destination Image as a moderator variable of the relationship between Perceived value and visit intention.

The research question below was conducted to ensure these main objectives were set:

*Research question 1:* What is the impact of Destination Image on Destination personality?

*Research question 2:* What is the impact of Destination Image on ecotourism attitude?

*Research question 3:* What is the impact of Destination Image on ecotourism perceived value?

*Research question 4:* What Destination Image influence on visit ecotourism intention?

## **2 LITERATURE REVIEW AND CONCEPTUAL FRAMEWORK**

Destination image can be defined as a tourist's general impression of a destination (Souiden, Ladhari, & Chiadmi, 2017), that is, it is 'sum of beliefs, ideas, and impressions' that a visitor has toward a certain place (Juganaru & Juganaru, 2008). The image is a portrayal of the visitor's attitude towards a number of cues related to the destination attributes (Ramseook-Munhurrin, Seebaluck, & Naidoo, 2015). The destination image in the minds of travellers plays an important role in their travel purchase decisions and then, stimulating their intention to visit (Beerli & Martín, 2004). The main factors considered by travellers at a destination are natural and scenic resources, accessibility, cultural resources, security, nightlife and entertainment, and quality/price ratio (Baloglu, 1997). Ramseook-Munhurrin, Seebaluck, & Naidoo (2015) describe the destination image as consisting of three components: the product, for instance, the quality of the attraction; the second one as the behaviour and attitude of the destination hosts; and thirdly the environment: weather, scenery, and facilities.

Destination Image has been one of the areas of great interest for tourism scholarly inquiry; and its importance in relation to the overall success of a destination has been acknowledged by destination marketing-related literature (Draper & Minca, 1997; Kuo, Wu, & Deng, 2009) DI is considered as a strong element of a destination to develop competitive advantages (Baloglu & Brinberg, 1997), because, as highlighted by (Ahmed, 1996) "destinations mainly compete based on their perceived images relative to competitors in the marketplace". In addition, (Chew & Jahari, 2014; Fesenmaier & MacKay, 1996) suggested that by studying the DI of a country, it is possible to better understand destination selection processes of tourists, as it is an element influencing tourists' behaviour before, during and after the visitation of a place. This opinion has been supported by Chew and Jahari (2014), who considered that the study of DI is of great importance because it influences "tourists' decision-making and behaviour". Likewise, DI is an element that contributes to the tourist's loyalty to a destination (Chen & Chen, 2010). Arguably, the perceptions of the DI potential tourists hold of a place, is a key player in the selection process of destination. In this respect, tourism literature "in general, indicates that what a prospective traveller believes or thinks about the natural environment, climate, people, infrastructure, quality of a place, may shape perceptions or images which will contribute, or not, to the selection of this place by the traveller" (Baloglu & McCleary, 1999; Chi, Pan, & Del Chiappa, 2018). In other words, studies have shown that destinations conveying positive images are most likely to be selected rather than those with negative images. In sum, it can be say that exploring the DI of a country is an imperative task every destination should undertake (Hultman, Kazeminia, & Ghasemi, 2015)

While destination image is based on the availability of local environmental resources and supporting site facilities (Jin, Lee, & Lee, 2015), it is also dependent on tourists' subjective perception of these attributes (Chen & Tsai, 2007; Cronin, Brady, & Hult, 2000; Lee, 2007).

Cognitive is defined as the belief or knowledge about a destination's attributes, whereas affective evaluation describes the feelings toward or attachment to these attributes due to experiences related to the scenic spots or wildlife appreciation (Ahmed, 1996; Chang & Horng, 2010; Lindberg & Johnson, 1997). What tourists actually experience, see, and feel helps them to form impressions of the tourist destination (Baker & Crompton, 2000; Kuo, Wu, & Deng, 2009; Shin, 2017). If the tour site can indeed attract tourists, satisfy their expectations and evoke

positive cognitive and affective perceptions of the destination, then this will be conducive to the destination image. Previous studies suggest that cognitive image can influence effective image (Chon, 1992; Gartner, 1989). In other words, tourist cognition of destination attributes will determine their feelings (positive or negative) about the travel destination. Numerous studies take an ex-post view of destination image, exploring destination image after the tourist has toured the destination. Destination image has also been modelled as an antecedent variable that correlates with perceived value (Ahmed, 1996; Ramseook-Munhurrun, Seebaluck, & Naidoo, 2015), satisfaction (Jin, Lee, & Lee, 2015; Lindberg & Johnson, 1997) and behavioural intention (Chon, 1990; Ha & (Shawn) Jang, 2010; Williams & Soutar, 2009). This component responds to the behavioural attitudes towards the destination and is basically how one behaves in relation to the aforementioned two components. It is the point where an individual decides to travel or not. Both the cognitive and affective aspects of destination image have different roles, and their impacts vary according to specific circumstances.

Because the image concept is subjective, individuals' perceptions of the tourist destination image tend to vary greatly (Buonincontri et al., 2017). Consequently, the overall image of the destination is a combination of cognitive/perceptual and affective components (Chang & Horng, 2010; Draper & Minca, 1997). This overall image could drive a person to travel to a destination or visit. Hence, it can be argued that the actual experience of visiting a destination will have an important effect on the DI from a cognitive and emotional point of view (Crompton, Fakeye, & Lue, 1992; Selby & Morgan, 1996).

Perceived value can be defined as “the consumer’s overall assessment of the utility of a product based on perceptions of what is received and what is given” (Chon, 1991; Fesenmaier & MacKay, 1996) pointed out that value is related to service quality, the costs paid by the customer, customer expectations for service and the actual delivered service. In a trade-off process, perceived value results from comparing the monetary sacrifices and the derived benefits associated with an acquisition (Agarwal, 2002; Fakeye & Crompton, 1991). Therefore, if perceived value lives up to customers’ desired value, then customers would be satisfied with the product.

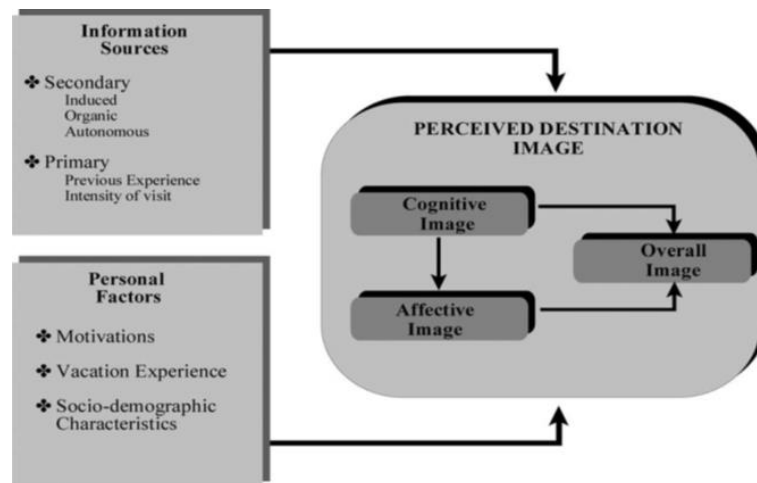

Fig. 1 – Model of the Formation of Destination Image. Source: Beerli & Martín (2004)

Destination formation model Customer satisfaction has received a lot of attention in marketing materials. Satisfaction is defined as customers' judgments about products or service fulfilment (Alford, 1998). One of the key factors of destination marketing success is traveller satisfaction as it influences destination selection and decision to visit. (Lee, 2009). Loyalty signals customers' attitudes and behaviours towards the products and services received and their repeat usage (Agarwal, 2002; Kazeminia, Hultman, & Mostaghel, 2016). Previous studies have confirmed the relationship between customer satisfaction and loyalty (Chen & Tsai, 2007;



Chen, Shang, & Li, 2014; Cronin, Brady, & Hult, 2000). Therefore, it is important to examine the concept of the image and its relationship with the satisfaction obtained to determine visitor intent and propose a destination (Souiden, Ladhari, & Chiadmi, 2017; Hongmei Zhang, Wu, & Buhalis, 2018). A number of studies in the field of tourism found satisfaction has an influence on tourists' future behavioural intentions (Kuo, Wu, & Deng, 2009; Sekaran & Bougie, 2016). Positive travel experiences in terms of services, products and other resources provided by the destination could induce positive word-of-mouth (WOM) recommendations as well as repeat visits (Alrawadieh, Alrawadieh, & Kozak, 2019; Chang & Horng, 2010; Dann, 1996)

## **2.1 Destination personality**

While destination image has been the focus of tourism research for several decades, destination personality has received less attention from researchers, because the concept is quite new in the tourism field (Chen & Tsai, 2007; Gursoy, Jurowski, & Uysal, 2002). Positioning destinations on the basis of their functional attributes make them less distinguishable and easily substitutable. Therefore, using additional traits and selling propositions such as destination personality may contribute to differentiating tourism places and encouraging tourists (Dann, 1996; Haahti, 1986)

Destination marketers use destination personality to differentiate and position their branded cities in a highly competitive tourism marketplace (Chen & Tsai, 2007; Selby & Morgan, 1996). As a matter of fact, destination personality is becoming a more viable metaphor for destination branding and positioning (Crompton, Fakeye, & Lue, 1992).

One of the most known models for investigating personality traits is the Big Five Model (Buonincontri et al., 2017; Draper & Minca, 1997). Its five factors are openness to experience (e.g., people's appreciation of art, adventure, curiosity, etc.), conscientiousness (e.g., people's consideration of others when making decisions, their self-discipline, strive for achievement), extraversion (e.g., people's interest in other people and external events, etc.), agreeableness (e.g., people's compatibility with other people, their concern for social harmony, kindness and generosity, etc.) and neuroticism (e.g., shows people's negative emotions such as anger, anxiety, or depression, emotional reactivity and vulnerability to stress, etc.). Building on the Big Five model of human personality, (Sternberg, 1997) has proposed the Brand Personality Scale (BPS) that better describes the personality attributes of products and brands. Since then, (Chi, Pan, & Del Chiappa, 2018; Moon & Han, 2018) scale has been widely employed as a measure of product brand personality. (Crompton, 1979) defines brand personality as "the set of human characteristics associated with a brand". Brand personality contributes to the development of positive brand evaluation, brand preferences, brand trust, brand effect, and brand loyalty (Qu, Kim, & Im, 2011; Selby & Morgan, 1996). It is a central component of brand identity, which is the brand, meaning that a firm wants to convey to its target consumers. Brand image, however, is the consumers' interpretation of the brand's identity (Kazemina, Hultman, & Mostaghel, 2016; Ryan & Montgomery, 1994). Academics argue that brand personality is best-comprehended from the sender's viewpoint, whereas the brand image is best-understood from the receiver's viewpoint (Agarwal, 2002; Strydom, 2010). Also, brand personality refers to the symbolic function of a brand, whereas brand image refers to both symbolic and functional benefits (Heng Zhang & Lei, 2012).

## **2.2 Behavioural intention**

Favourable behavioural intent often represents customer loyalty. Customer loyalty is an important goal in the consumer marketing community because it is a key ingredient for the company's long-term or long-term viability. Loyalty measurement can provide a better understanding of customer retention. Retaining existing customers often costs much less than

acquiring new customers. Moreover, loyal customers are more likely to refer friends, relatives or other potential customers to your product/service by acting as a free word of mouth advertising agency. (Juvan & Dolnicar, 2016; Morley L., 1992). Loyalty can be identified and assessed by both attitude and behavioural measures. The attitude measure refers to a specific desire to continue the relationship with the service provider while the behavioural perspective refers to the concept of repeated sponsorship.

### 3 RESEARCH FRAMEWORK AND RESEARCH HYPOTHESIS

In order to exam the relationship between Destination Image and visit ecotourism behavioural intention, this study uses the conceptual, behavioural theory.

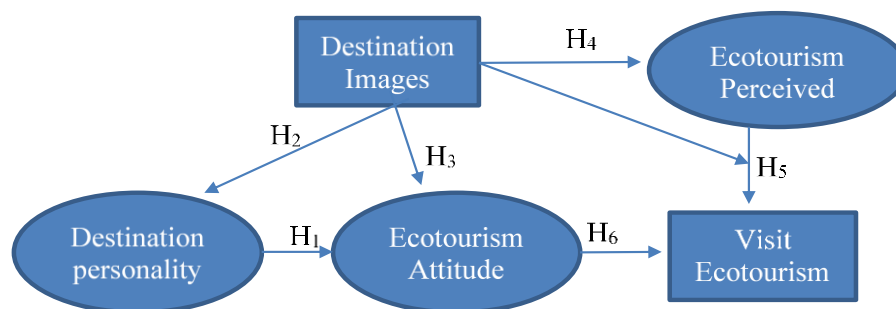

Fig. 2 – The structure model of Theoretical. Source: own research

#### 3.1 The impact of destination personality on ecotourism attitude

An attitude toward a destination is the opinion favourable, unfavourable or neutral-that a tourist has about the destination. (Ahmed, 1996) states that attitude towards a destination is a key factor in explaining the influence a place may have on tourists' decision-making.

In the marketing literature, the attitude has been shown to be related to behavioural intentions. The theory of planned behaviour stipulates that individual behavioural intentions are influenced by attitudes, perceived behavioural controls toward behaviour, and subjective norms (Chi, Pan, & Del Chiappa, 2018; Ajzen, 1991). Juvan & Dolnicar (2016) find no significant link between attitude and behavioural intention of choosing a travel destination, many other studies support the relationship between attitudes and destination choice (Kazeminia, Hultman, & Mostaghel, 2016), attitudes and overall satisfaction (overall impression, overall performance), and attitudes and tourist behavioural intentions (Fesenmaier & MacKay, 1996; Ramseook-Munhurrun, Seebaluck, & Naidoo, 2015). Therefore, the following hypothesis is proposed:

*Hypothesis 1:* Destination personality has a positive and significant impact on attitude toward the destination

#### 3.2 The impact of destination image on destination personality and attitude

Baloglu & McCleary (1999) argue that while several studies have attempted to explain both concepts, there is much ambiguity surrounding the relationship between brand image and brand personality. Both concepts were used interchangeably in the literature (Baker & Crompton, 2000; Lindberg & Johnson, 1997). For Cronin, Brady and Hult (2000), brand personality and the affective component of brand image are interrelated. This opinion is further supported by studies stipulating that the affective component of image can be associated with some dimensions of destination personality (i.e., sincerity, excitement, and conviviality) (Gallarza, Saura, & García, 2002; Hultman, Kazeminia, & Ghasemi, 2015). However, they add that a

fuzzy conceptualization and a lack of empirical studies have hindered the understanding of the relationship between brand image and brand personality. In fact, there is no general agreement on their causal relationship (Chang & Horng, 2010; Cronin, Brady, & Hult, 2000; Echtner & Ritchie, 1993).

As for the conceptualization of the relationship between destination personality and destination image, this study proposes to use the widely recognized cognitive-affective-conative attitude model of (Altunel & Erkut, 2015; Cronin, Brady, & Hult, 2000). This conceptualization, stipulating that attitude is formed on the basis of cognitive, affective, and behavioural components, has dominated the marketing and consumer psychology literature. Additionally, (Chi, Pan, & Del Chiappa, 2018; Gallarza, Saura, & García, 2002) find support for the attitude theory in the tourism industry. Hence, the present study proposes the following hypothesis:

*Hypothesis 2:* Destination image has a significant positive impact on destination personality.

*Hypothesis 3:* Destination image has a significant positive impact on ecotourism attitude

### **3.3 The impact of destination image on ecotourism perceived value**

Baker & Crompton (2000) and Shin (2017) found that the destination image indirectly influences satisfaction via the trip quality–perceived value path and has both direct and indirect effects on behavioural intentions. Yoshida (2017) developed a conceptual model to explain destination loyalty by examining the causal relationships among destination image, tourist attribute, and overall satisfaction and destination loyalty. Their results supported the proposed destination loyalty model, which advocated that destination image directly influenced attribute satisfaction; destination image and attribute satisfaction were both direct antecedents of overall satisfaction; and overall satisfaction and attribute satisfaction, in turn, had a direct and positive impact on destination loyalty. However, their study did not examine the effect of tourists' perceived value on the destination loyalty model. Based on the review, the hypotheses, therefore, would be:

*Hypothesis 4:* The higher the destination image, the higher the perceived value

### **3.4 The impact of perceived value to visit ecotourism behavioural intention**

Analysis of the relationship between the concepts of perceived value and intended future behaviour has found that perceived value often stands out as an antecedent and a key determinant of their future behavioural intentions (Juvan & Dolnicar, 2016; Lee, 2007; Ramseook-Munhurrun, Seebaluck, & Naidoo, 2015). Because of the narrow focus of this study, the empirical analysis of the relationship between perceived value, and behavioural intentions was focused on ecotourism. Therefore, the hypotheses would be given:

*Hypothesis 5:* The ecotourism perceived value has a significant positive impact on behavioural intention to visit.

### **3.5 The impact of attitude to visit ecotourism behavioural intention**

*Hypothesis 6:* The ecotourism perceived value has a significant positive impact on visit behavioural intention.

## 4 METHODOLOGY

### 4.1 Research design

This study uses research paradigms of post-positivism because the Methodological stance of this study is that the hypotheses will be tested and more emphasis placed on the context (Sekaran & Bougie, 2016). This investigation uses the research approach of deduction, which is that from the more general to the more specific. Moreover, if research starts with a theory, often developed from a reading of academic literature and the researcher designs a research strategy to test the theory, the deductive approach is used (Trochim & Donnelly, 2008). This deductive approach is illustrated as follows:

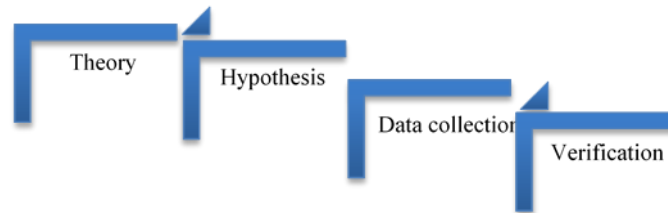

Fig. 3 – The structure of method design. Source: Trochim & Donnelly (2008)

This research applies the survey research, which uses mix-methods of qualitative and quantitative for the investigation. The qualitative stage will be applied with the technique of the semi-structured interview to explore whether important variables or relationships are missing from the model. The quantitative stage with the pilot study and full study will be investigated.

First of all, through analysing and the existing literature, the study proposes a conceptual model. After building the constructs' measurement for the proposed research model, all survey items, originally published in English, are converted into Vietnam. When the translation is completed, a semi-structured interview and the pilot test are carried out to ensure comprehension of all questions by subjects. This step will explore to identify whether or not the variable or relationships are lacking in the model. After the pilot test, the questionnaire is completed, the survey items are refined. Finally, the official survey is collected through an offline survey for respondents.

### 4.2 Data collection

#### Qualitative

The qualitative research intends to give a complete and total description of this research by semi-structured interview people. The data collected is then turned to utilize to explore whether important variables or relationships are missing from the model. 10 tourists will be used as a pre-test to collect data. Paper and record are used as techniques for the interview.

#### Quantitative

As the study is conducting quantitative data, the study will be using a questionnaire as an instrument for the primary data collection; the result will be analysed and interpreted using descriptive statistics. By doing this way, the pilot study with the sample size of 100 tourists would be run firstly, the main goals of the pilot study to assess the items' accuracy in representing corresponding constructs and evaluate the quality of content and reliability of measures scale. Finally, the full study would be carried out in a range sample of more than 300 visitors using a Likert scale (1-5) questionnaire.

### 4.3 Data analysis

#### Qualitative analysis

The data will be analysed by excel with table analysis for coding and analysis to identify new variables and confirm variables that have been found in the literature review. For example, some questions can be used for qualitative analysis. The software of NVIVO may be applied to analyse the quantitative data.

#### Quantitative analysis

In order to achieve the purpose of this research and test hypotheses, SPSS 22.0, and SmartPLS 3.0 will be employed to analyse the collected data. This study has conducted the following data analysis. To delineate underlying factors of experience quality, this research conducts an exploratory factor analysis (EFA) using the principal component method with varimax rotation. A confirmatory factor analysis (CFA) is first used to confirm the factor loadings of the constructs (i.e. destination image, destination personality, perceived value, and behavioural intentions) and to assess the model fit.

#### Descriptive Statistic Analysis

Descriptive statistical analysis will be used to analyse the characteristics of each variable. Firstly, respondents' profiles will be illustrated using descriptive statistic techniques in terms of the frequency of distribution. Then the means and standard deviation of both independent and dependent variables will be illustrated.

#### Factor analysis and Reliability Test

To verify the dimensionality and reliability of constructs of this study, purification processes, including factor analysis and Cronbach's alpha analysis were conducted in this study. Factor analysis examined the basic structure of the data. To maintain the most flexibility for this exploratory study, the decision was made to test each sub-dimension separately as a discrete construct. Coefficient (Cronbach's) alpha measured the internal consistency of each identified dimension. A confirmation factor analysis (CFA) is first used to confirm the factor loadings of the constructs and to assess the model fit. Convergent validity of the CFA result should be supported by item reliability, construct reliability and average variance extracted.

Tab. 1 – Confirmatory Factor Analysis. Source: own research

Constructs	Items	Item reliability			Construct reliability	Average variance extracted
		Standardized factor loading	Standard errors	t-value		
Destination Image						
Destination personality						
Perceived value						
Attitude						
Behavioral intention						

#### Hypothesis testing

The partial least squares (PLS) approach is employed with SmartPLS 3.0 to analyse the measurement model. The PLS approach (a variance-based SEM method), not covariance-based SEM methods such as LISREL and AMOS, is chosen because some indicators are formative, and the main objective is to determine the predictive validity of the specified paths, not to establish a causal model with the best fit. Additionally, the PLS approach allows for the simultaneous testing of both the measurement and structural models.

## Evaluation of Measurement Model

The model on this study has constructs that more formative, PLS uses component-based algorithms, and can estimate formative constructs. To measure the reliability and validity of the measurement model through several criteria, such as R<sup>2</sup> value, average variance extracted (AVE), composite reliability (CR), Cronbach's alpha. The R<sup>2</sup> value of the dependent constructs measures the amount of explained variance of each endogenous latent variable. AVE is the measurement of the amount.

## 5 CONCLUSION AND DISCUSSION

This study examines the influence of destination imagery on tourists' intentions and decisions on tourism destinations for ecotourism in Thua Thien Hue Province, Vietnam. The target image is an independent variable, the intention of a visitor is to intervene and the access decision is a dependent variable. The study explained with a quantitative method used. The sample size is 365 respondents. The purposeful sampling technique is applied to the criteria of travellers using eco-tourism products. Data is collected with a questionnaire and processed with path analysis. These results indicate that the changing destination image has a direct and significant impact on the intention of tourists to visit x%. A changed target image has a direct and significant effect on access decisions in y%. The intention to change travel has directly and significantly affected the decision to access up to z%. Based on these results, ecotourism activities should continue to try to build a positive image and improve communication between local authorities and local communities to enhance cooperation to improve the environment natural school in Thua Thien Hue province.

## References

- Agarwal, S. (2002). Restructuring seaside tourism: The resort Lifecycle. *Annals of Tourism Research*, 29(1), 25-55. doi: 10.1016/S0160-7383(01)00002-0
- Ahmed, Z. U. (1996). The need for the identification of the constituents of a destination's tourist image: A promotional segmentation perspective. *The Tourist Review*, 51(2), 44-57. doi: 10.1108/eb058223
- Ajzen, I. (1991). The theory of planned behavior. *Organizational Behavior and Human Decision Processes*, 50(1991), 179-211. doi: 10.1016/0749-5978(91)90020-T
- Alford, P. (1998). Positioning the destination product - can regional tourist boards learn from private sector practice? *Journal of Travel and Tourism Marketing*, 7(2), 53-68. doi: 10.1300/J073v07n02\_03
- Alrawadieh, Z., Alrawadieh, Z., & Kozak, M. (2019). Exploring the impact of tourist harassment on destination image, tourist expenditure, and destination loyalty. *Tourism Management*, 73, 13-20. doi: 10.1016/j.tourman.2019.01.015
- Altunel, M. C., & Erkut, B. (2015). Cultural tourism in Istanbul: The mediation effect of tourist experience and satisfaction on the relationship between involvement and recommendation intention. *Journal of Destination Marketing and Management*, 4(4), 213-221. doi: 10.1016/j.jdmm.2015.06.003
- Baker, D. A., & Crompton, J. L. (2000). Quality, satisfaction and behavioral intentions. *Annals of Tourism Research*, 27(3), 785-804. doi: 10.1016/S0160-7383(99)00108-5

- Baloglu, S. (1997). The relationship between destination images and sociodemographic and trip characteristics of international travellers. *Journal of Vacation Marketing*, 3(3), 221-233. doi: 10.1177/135676679700300304
- Baloglu, S., & Brinberg, D. (1997). Affective images of tourism destinations. *Journal of Travel Research*, 35(4), 11-15. doi: 10.1177/004728759703500402
- Baloglu, S., & McCleary, K. W. (1999). A model of destination image formation. *Annals of Tourism Research*, 26(4), 868-897. doi: 10.1016/S0160-7383(99)00030-4
- Beerli, A. N., & Martín, J. D. (2004). Factors Influencing Destination Image. *Annals of Tourism Research*, 31(3), 657-681. doi: 10.1016/j.annals.2004.01.010
- Buonincontri, P., Morvillo, A., Okumus, F., & van Niekerk, M. (2017). Managing the experience co-creation process in tourism destinations: Empirical findings from Naples. *Tourism Management*, 62, 264-277. doi: 10.1016/j.tourman.2017.04.014
- Chang, T.-Y., & Horng, S.-C. (2010). Conceptualizing and measuring experience quality: the customer's perspective. *The Service Industries Journal*, 30(14), 2401-2419. doi: 10.1080/02642060802629919
- Chen, C.-F., & Chen, F.-S. (2010). Experience quality, perceived value, satisfaction and behavioral intentions for heritage tourists. *Tourism Management*, 31(1), 29-35. doi: 10.1016/j.tourman.2009.02.008
- Chen, C.-F., & Tsai, D. (2007). How destination image and evaluative factors affect behavioral intentions? *Tourism Management*, 28(4), 1115-1122. doi: 10.1016/j.tourman.2006.07.007
- Chen, Y.-C., Shang, R.-A., & Li, M.-J. (2014). The effects of perceived relevance of travel blogs' content on the behavioral intention to visit a tourist destination. *Computers in Human Behavior*, 30, 787-799. doi: 10.1016/j.chb.2013.05.019
- Chew, E. Y. T., & Jahari, S. A. (2014). Destination image as a mediator between perceived risks and revisit intention: A case of post-disaster Japan. *Tourism Management*, 40, 382-393. doi: 10.1016/j.tourman.2013.07.008
- Chi, C. G.-Q., Pan, L., & Del Chiappa, G. (2018). Examining destination personality: Its antecedents and outcomes. *Journal of Destination Marketing & Management*, 9, 149-159. doi: 10.1016/j.jdmm.2018.01.001
- Chon, K. (1990). The role of destination image in tourism: A review and discussion. *The Tourist Review*, 45(2), 2-9. doi: 10.1108/eb058040
- Chon, K. (1992). The role of destination image in tourism: An extension. *The Tourist Review*, 47(1), 2-8. doi: 10.1108/eb058086
- Chon, K. S. (1991). Tourism destination image modification process. Marketing implications. *Tourism Management*, 12(1), 68-72. doi: 10.1016/0261-5177(91)90030-W
- Crompton, J. L. (1979). An Assessment of the Image of Mexico as a Vacation Destination and the Influence of Geographical Location Upon That Image. *Journal of Travel Research*, 17(4), 18-23. doi: 10.1177/004728757901700404
- Crompton, J. L., Fakeye, P. C., & Lue, C.-C. (1992). Positioning: The Example of the Lower Rio Grande Valley in the Winter Long Stay Destination Market. *Journal of Travel Research*, 31(2), 20-26. doi: 10.1177/004728759203100204

- Cronin, J. J., Brady, M. K., & Hult, G. T. M. (2000). Assessing the effects of quality, value, and customer satisfaction on consumer behavioral intentions in service environments. *Journal of Retailing*, 76(2), 193-218. doi: 10.1016/S0022-4359(00)00028-2
- Dann, G. M. S. (1996). Tourists' images of a destination an alternative analysis. *Journal of Travel and Tourism Marketing*, 5(1-2), 41-55. doi: 10.1300/J073v05n01\_04
- Draper, D., & Minca, C. (1997). Image and destination: A geographical approach applied to Banff National Park, Canada. *The Tourist Review*, 52(2), 14-24. doi: 10.1108/eb058244
- Echtner, C. M., & Ritchie, J. R. B. (1993). The Measurement of Destination Image: An Empirical Assessment. *Journal of Travel Research*, 31(4), 3-13. doi: 10.1177/004728759303100402
- Fakeye, P. C., & Crompton, J. L. (1991). Image Differences between Prospective, First-Time, and Repeat Visitors to the Lower Rio Grande Valley. *Journal of Travel Research*, 30(2), 10-16. doi: 10.1177/004728759103000202
- Fesenmaier, D., & MacKay, K. (1996). Deconstructing destination image construction. *The Tourist Review*, 51(2), 37-43. doi: 10.1108/eb058222
- Gallarza, M. G., Saura, I. G., & García, H. C. (2002). Destination image: Towards a conceptual framework. *Annals of Tourism Research*, 29(1), 56-78. doi: 10.1016/S0160-7383(01)00031-7
- Gartner, W. C. (1989). Tourism image: attribute measurement of state tourism products using multidimensional scaling techniques. *Journal of Travel Research*, 28(2), 16-20. doi: 10.1177/004728758902800205
- Gursoy, D., Jurowski, C., & Uysal, M. (2002). Resident attitudes: A structural modeling approach. *Annals of Tourism Research*, 29(1), 79-105. doi: 10.1016/S0160-7383(01)00028-7
- Ha, J., & (Shawn) Jang, S. (2010). Perceived values, satisfaction, and behavioral intentions: The role of familiarity in Korean restaurants. *International Journal of Hospitality Management*, 29(1), 2-13. doi: 10.1016/j.ijhm.2009.03.009
- Hahti, A. J. (1986). Finland's competitive position as a destination. *Annals of Tourism Research*, 13(1), 11-35. doi: 10.1016/0160-7383(86)90055-1
- Hultman, M., Kazemina, A., & Ghasemi, V. (2015). Intention to visit and willingness to pay premium for ecotourism: THE impact of attitude, materialism, and motivation. *Journal of Business Research*, 68(9), 1854-1861. doi: 10.1016/j.jbusres.2015.01.013
- Jin, N. P., Lee, S., & Lee, H. (2015). The Effect of Experience Quality on Perceived Value, Satisfaction, Image and Behavioral Intention of Water Park Patrons: New versus Repeat Visitors. *International Journal of Tourism Research*, 17(1), 82-95. doi: 10.1002/jtr.1968
- Juganaru, I., & Juganaru, M. (2008). Sustainable tourism types. *Annals of University of Craiova-Economic Sciences Series*, 2(36), 797-804. Retrieved from <https://www.ceeol.com/search/article-detail?id=126534>
- Juvan, E., & Dolnicar, S. (2016). Measuring environmentally sustainable tourist behaviour. *Annals of Tourism Research*, 59, 30-44. doi: 10.1016/j.annals.2016.03.006
- Kazemina, A., Hultman, M., & Mostaghel, R. (2016). Why pay more for sustainable services? The case of ecotourism. *Journal of Business Research*, 69(11), 4992-4997. doi: 10.1016/j.jbusres.2016.04.069



- Kuo, Y.-F., Wu, C.-M., & Deng, W.-J. (2009). The relationships among service quality, perceived value, customer satisfaction, and post-purchase intention in mobile value-added services. *Computers in Human Behavior*, 25(4), 887-896. doi: 10.1016/j.chb.2009.03.003
- Lee, T. H. (2009). A Structural model to examine how destination image, attitude, and motivation affect the future behavior of tourists. *Leisure Sciences*, 31(3), 215-236. doi: 10.1080/01490400902837787
- Lee, T. H. (2007). An ecotourism behavioural model of national forest recreation areas in Taiwan. *International Forestry Review*, 9(3), 771-785. doi: 10.1505/ifor.9.3.771
- Lindberg, K., & Johnson, R. L. (1997). Modeling resident attitudes toward tourism. *Annals of Tourism Research*, 24(2), 402-424. doi: 10.1016/S0160-7383(97)80009-6
- Moon, H., & Han, H. (2018). Destination attributes influencing Chinese travelers' perceptions of experience quality and intentions for island tourism: A case of Jeju Island. *Tourism Management Perspectives*, 28, 71-82. doi: 10.1016/j.tmp.2018.08.002
- Morley L., C. (1992). A microeconomic theory of international tourism demand. *Annals of Tourism Research*, 19, 250-267. doi: 10.1016/0160-7383(92)90080-9
- Qu, H., Kim, L. H., & Im, H. H. (2011). A model of destination branding: Integrating the concepts of the branding and destination image. *Tourism Management*, 32(3), 465-476. doi: 10.1016/j.tourman.2010.03.014
- Ramseook-Munhurrun, P., Seebaluck, V. N., & Naidoo, P. (2015). Examining the Structural Relationships of Destination Image, Perceived Value, Tourist Satisfaction and Loyalty: Case of Mauritius. *Procedia - Social and Behavioral Sciences*, 175, 252-259. doi: 10.1016/j.sbspro.2015.01.1198
- Ryan, C., & Montgomery, D. (1994). The attitudes of Bakewell residents to tourism and issues in community responsive tourism. *Tourism Management*, 15(5), 358-369. doi: 10.1016/0261-5177(94)90090-6
- Sekaran, U., & Bougie, R. (2016). *Research methods for business: a skill-building approach*. London: Wiley.
- Selby, M., & Morgan, N. J. (1996). Reconstructing place image. *Tourism Management*, 17(4), 287-294. doi: 10.1016/0261-5177(96)00020-9
- Shin, D.-H. (2017). Conceptualizing and measuring quality of experience of the internet of things: Exploring how quality is perceived by users. *Information & Management*, 54(8), 998-1011. doi: 10.1016/j.im.2017.02.006
- Souiden, N., Ladhari, R., & Chiadmi, N. E. (2017). Destination personality and destination image. *Journal of Hospitality and Tourism Management*, 32, 54-70. doi: 10.1016/j.jhtm.2017.04.003
- Sternberg, E. (1997). The iconography of the tourism experience. *Annals of Tourism Research*, 24(4), 951-969. doi: 10.1016/S0160-7383(97)00053-4
- Strydom, M. (2010). *Integrated Rapid Transport: Is the City of Cape Town utilising its full potential?* Retrieved from [https://dspace.nwu.ac.za/bitstream/handle/10394/4417/Strydom\\_M.pdf?sequence=2](https://dspace.nwu.ac.za/bitstream/handle/10394/4417/Strydom_M.pdf?sequence=2)
- Williams, P., & Soutar, G. N. (2009). Value, Satisfaction and Behavioral Intentions in an Adventure Tourism Context. *Annals of Tourism Research*, 36(3), 413-438. doi: 10.1016/j.annals.2009.02.002

- Yoshida, M. (2017). Consumer experience quality: A review and extension of the sport management literature. *Sport Management Review*, 20(5), 427-442. doi: 10.1016/j.smr.2017.01.002
- Zhang, H., & Lei, S. L. (2012). A structural model of residents' intention to participate in ecotourism: The case of a wetland community. *Tourism Management*, 33(4), 916-925. doi: 10.1016/j.tourman.2011.09.012
- Zhang, H., Wu, Y., & Buhalis, D. (2018). A model of perceived image, memorable tourism experiences and revisit intention. *Journal of Destination Marketing & Management*, 8, 326-336. doi: 10.1016/j.jdmm.2017.06.004

### **Contact information**

#### **Vo Viet Hung**

Tomas Bata University in Zlín, Faculty of Management and Economics  
Mostní 5139, 76001, Zlín, Czech Republic  
E-mail: vvo@utb.cz  
ORCID: 0000-0003-0705-8419

#### **doc. Ing. Zuzana Tučková, Ph.D.**

Tomas Bata University in Zlín, Faculty of Management and Economics  
Mostní 5139, 76001, Zlín, Czech Republic  
E-mail: tuckova@utb.cz  
ORCID: 0000-0001-7443-7078

#### **Hung Cuong Hoang**

Tomas Bata University in Zlín, Faculty of Management and Economics  
Mostní 5139, 76001, Zlín, Czech Republic  
E-mail: hoang@utb.cz  
ORCID: 0000-0003-0732-8319

doi: 10.7441/dokbat.2019.038

# INTRODUCTORY ANALYSIS OF POSSIBILITY TO UTILIZE POTENTIAL OF LEAN AND AGILE MANUFACTURING METHODS IN CONDITIONS OF INDUSTRY 4.0

*Mikuláš Hurta, Darja Noskievičová*

## Abstract

The paper presents Lean and Agile Manufacturing systems in context of the fourth industrial revolution. The aim of the paper is to describe relation between Lean/Agile Manufacturing and Industry 4.0, find their coherences and outline possible ways of utilization of Lean Manufacturing tools and methods in conditions of Industry 4.0. Methodology is based on theoretical research with composition “from general to concrete.” The first chapter is focused on description of the current situation and trends in a field of manufacturing system. The second chapter provides a theoretical background of Lean and Agile Manufacturing and Industry 4.0 needed for further comparison. Next chapter, the third one, can be taken as the core of the paper as it brings specifications of differences and similarities between both analyzed manufacturing systems and leads into summarization of possible utilization of concrete Lean Manufacturing tools in conditions of Industry 4.0. The last three chapters belong to methodology, results and conclusion. Found coherences and disparities between the systems are the results of the paper. Based on this comparison it was concluded that there are not only wide options for utilization of Lean Manufacturing methods in Industry 4.0 environment but also the fact that some of Lean Manufacturing tools create a necessary base for Industry 4.0.

**Keywords:** *Lean Manufacturing, Agile Manufacturing, Industry 4.0, production systems, production management*

## 1 INTRODUCTION

In eighties, Bennis predicted that “the factory of the future will have only two employees, a man and a dog. The man will be there to feed the dog. The dog will be there to keep the man from touching the equipment” (Fisher, 1991). Now, more than thirty years later, the prediction becomes to be actual in regards to current trends in manufacturing systems.

Nowadays, companies use a lot of different approaches to production systems depending on particular business field, a company size or region standards. Generally, we can point out that one of the widely used concept is Lean Manufacturing which is based on Toyota Production System formed in Japan. The main idea of the Lean Manufacturing is to increase production productivity and effectivity by reducing complexity and costs by eliminating waste (defects, overproduction, waiting, transportation, inventory, motion, extra-processing and non-utilized talent) and activities without added value across all company processes (Küpper et al., 2017).

Agile Manufacturing is often perceived like a part of Lean Manufacturing, but some business segments like IT field use it separately. According to Fountain (2017), “Agile Manufacturing is about being able to move quickly and easily in response to changing customer demand”. It means that the main emphasis is given to connecting customers, company management and technologies into a well-functioning system. The Lean and Agile Manufacturing approaches are facing to emerging of the fourth industrial revolution.

“The fourth industrial revolution” is a designation of the Industry 4.0 manufacturing system which is based on an utilization of cyber-physical systems and related automatization and

digitalization with intention to create a mass customization and mass personalization functioning characterized by adaptability, efficiency, flexibility and high involvement of customers and other business partners (Yao & Lin, 2015). In comparison with the previous industrial revolutions which were a result of some technical progress (mechanization, electricity, IT), the new industrial revolution stands on Internet and social market aspects as personalization, customization, social computing or wisdom in manufacturing, while the technical progress (cyber-physical systems) is just an essential tool for its feasibility, but it is not a focus of the revolution.

Yao and Lin (2015) also highlighted an economic perspective of the revolution as a creation of an ideal production system where personalized/customized individual demands are fulfilled by smart manufacturing and 3D printing in maximally effective way reducing inventory, risk of forecasting, costs and response time, raising product fitness, variety, customer involvement, personalization and creating self-expression, uniqueness and continuous design evolution. As shown in Fig. 1, the ideal production system connects advantages of economies of scale and economies of scope and facilitates to make low volumes of different products for wide range of different target groups with increasing of profits.

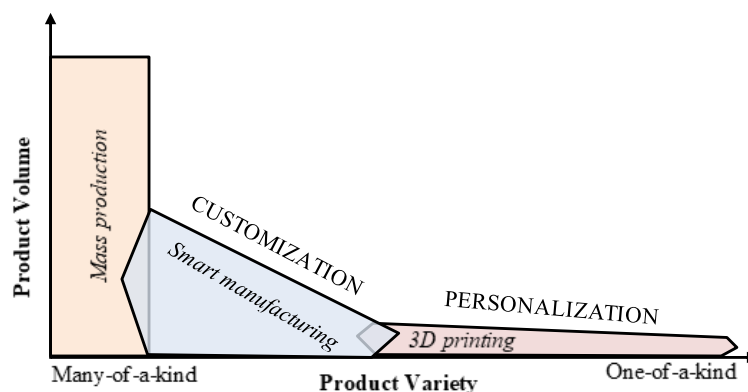

Fig. 1 – Product volume and product variety in conditions of Industry 4.0. Source: Yao & Lin (2015)

Regarding nomenclature of the new industrial revolution the “Industry 4.0” arisen from German Federal Government’s high-tech national innovation strategy which was an impulse for similar national government strategies in USA, Japan, Taiwan or Republic of Korea (Shyuac, Kuo, & Ding, 2019) and also in the Czech Republic (Mařík, 2016).

From competition point of view, it is important for companies to successfully manage the implementation of the new manufacturing system because it leads to increasing of its productivity (Kagermann et al., 2016). According to Žák and Zajíc (2017), based on IDC analysis the conception of Industry 4.0 should lead to productivity increasing by 30% in the Czech Republic. The Industry 4.0 implementation process will be a key.

Main questions related to the implementation process are following. What is a relation between Lean/Agile Manufacturing and incoming Industry 4.0? Is it possible to manage the transformation without correctly established process management? Which aspects, knowledge and tools of Lean and Agile Manufacturing could create a necessary base for the Industry 4.0? Or is the Industry 4.0 just a subset of Lean?

Topics related with Lean Manufacturing or Industry 4.0 are quite frequent. However, a research gap can be seen in the areas of their relation. This paper aims to outline coherences between Lean/Agile Manufacturing and Industry 4.0 important for the implementation and integration process as well as clarify relations between Lean/Agile manufacturing and Industry 4.0.

## **2 METHODOLOGY**

The paper is a theoretical development based on review about Lean Manufacturing, Industry 4.0 and their relation aspects with the use of professional sources and personal experiences of the first author of the paper. The sources include predominantly professional articles and bibliography from the recent years. The first author of the paper has long-term experiences with Lean Manufacturing due to production management positions that he holds in various companies.

An emphasis was given to selecting up-to-date sources with a time frame of the last 5 years. Just two sources are out of the time frame – they were used because they provide a historical context important for the paper.

Within the specified time frame there were found 13,025 articles related to “Lean Manufacturing,” 6,583 articles related to “Agile Manufacturing,” and 88,974 articles related to “Industry 4.0.” For the mentioned articles search we used the database of ScienceDirect, for other searches ResearchGate and other databases were used. The articles and the other sources which were the most relevant to the key words and the topic of the paper were used. The searches led to the use of 19 journal articles and other electronic sources.

It is systematically constructed in the method with the order “from general to concrete.” In this way, firstly the manufacturing systems environment was presented, then Lean Manufacturing and Industry 4.0 were specified, connections between them were summarized and in the end the utilization of Lean Manufacturing methods in Industry 4.0 was outlined.

## **3 THEORETICAL BACKGROUND**

Before we will focus on concrete links between Lean/Agile Manufacturing and Industry 4.0 it is desirable to introduce these approaches in deeper details and expose their theoretical background.

### **3.1 Lean/Agile Manufacturing**

As has been mentioned, the roots of the Lean Manufacturing could be seen in Japan in seventies and eighties of the twentieth century. Taiichi Ohno, who was operating in the production department of the Japanese automotive enterprise Toyota, faced to American competition which was producing huge batch sizes to reduce long set-up times. Toyota was not able to manufacture such big production volume so he was searching for different ways how to reduce lead time between the ordering and the money income (Leyh, Martin, & Schäffer, 2017). The result was a manufacturing system built on waste reduction.

The reduction of wastes is achieved through Lean tools as Kanban, 5S, Heijunka, Jidoka, Andon, Poka-Yoke, SMED, Kaizen, VSM and others. Each application of the named tools is a standardized process way how to deal with the waste or wastes. Standardization is an important part of Lean manufacturing because it limits processes to the most efficient manner (blots manners with lower added value out).

Lean Manufacturing is a closed loop improvement system – it is ensured by the improvement kata and coaching kata (Tamás & Illés, 2016). Improvement kata is a principle which aims to establish continuous improvement system like PDCA (Plan, Do, Check, Act). As shown in Fig. 2, in practice it means that all processes are planned (standards, plans, diagrams, procedures, etc.), done (standards and plans application), then checked by data monitoring (check lists, audits, management checks, etc.) and followed by the evaluation of the collected data and

appropriate reactions and steps. Coaching kata is an approach how to systematically teach the improvement kata.

Agile Manufacturing concept was created in USA in nineties. It was an answer for the shift in the business situation which became more and more dynamic with a big pressure to change flexibility. Gunasekaran et al. (2018) wrote that “the early proponents of agility described it as a system with internal resource competencies to answer to customer dynamic demands with speed and flexibility”.

In a sense, it is a manufacturing system using special processes and tools for an ability to react on changing customer needs and requirements (with taking in account of costs and quality) in conditions of very dynamic market (Gunasekaran et al., 2018). That is the reason why it is often used in IT business field, concretely in software development through agile methods like SCRUM for example. Customers are directly involved into product design and development, in some systems also into production or quality processes. It allows to reduce processes and activities without added value and this is a linkage to Lean Manufacturing approach and the grounds why Agile Manufacturing became a part of Lean Manufacturing in some production systems over the times.

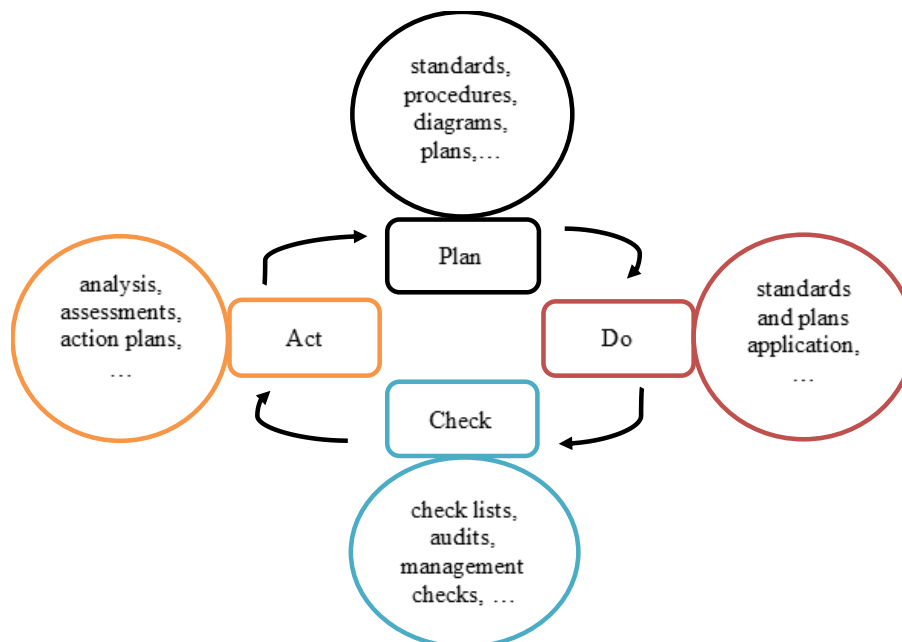

Fig. 2 – PDCA principle functioning. Source: own research

### 3.2 Industry 4.0

According to Marsh (2013), the beginning of the new industrial revolution is dated around 2005. German enterprises were under pressure of global competition regarding balance between product quality and manufacturing product costs. As a substantial part of the costs was labour costs, a lot of companies decided to solve it by relocation (or outsourcing) of their production capacities to countries with lower labour costs, while many German companies focused on adjusting of their business model to customization and fast time to market (Brettel et al., 2014). The companies choosing the second way started to integrate themselves into a cooperating network. Industry 4.0 was a conceptual reaction to the new industrial, business and social trends.

As was mentioned in Chapter 1, Internet plays the main role in the new industrial revolution. Industry 4.0 separates Internet of Things, Internet of People, Internet of Knowledge and Internet

of Services. Internet of Things allows to manufacturing to be smart by connecting of cyber and physical systems through data interactions. Internet of People creates online integrations for customers, designers, sellers, stakeholders, managers and others, hereby it deletes barriers between them and builds a ground for socialized manufacturing (Yao & Lin, 2015). Internet of Knowledge is imaginable as information/knowledge transferred from data received from smart devices (Internet of Things). Then the information/knowledge is usable for wide range of subjects. Internet of Services brings the concepts of Service-Oriented Architecture and Cloud services and hereby enables to obtain flexible and service-oriented production processes (Reis & Gonçalves, 2018). These four Internets (Internet of Things, Internet of People, Internet of Knowledge and Internet of Services) are the key technology for the cyber-physical systems.

Most of authors confine the description of the Industry 4.0 base to cyber-physical systems (CPS), however Yao and Lin (2015) extended this base to socio-cyber-physical systems (SCPS), where Internet of People is the technology in the social world, Internet of Knowledge and Internet of Services are match to cyber world and Internet of Things to the physical world. The technologies into the worlds collaborate and construct SCPS-based manufacturing.

Industry 4.0 as SCPS-based manufacturing can be represented in a following manner. In the social world people share their ideas, opinions, culture, beliefs, make commitments, deals, contracts and communicate or cooperate via Internet of People (Yao & Lin, 2015). Pursuant to these actions they build their customer requirements for manufacturing and through Internet of Services (via right application composition) assign the requirements to production companies, concretely to their smart manufacturing devices. The devices are bridged by Internet of Things; thus, they share data between each other and also between them and humans in real time (Reis & Gonçalves, 2018). The data are transferred to information and knowledge through Internet of Knowledge where they are distributed back for people use (Internet of People), or into Internet of Services for further development of application compositions.

This system leads to new possibilities in mass customization and opens a new manufacturing variability with keeping or increasing of economic profitability. The system is conditioned by digitalization and automation (Schumacher, Sihn, & Erol, 2016).

## **4 RELATION BETWEEN LEAN/AGILE MANUFACTURING AND INDUSTRY 4.0**

This Chapter points differences and similarities between Lean/Agile Manufacturing and Industry 4.0 and follows them to describe their relation. For this chapter need, the designation of Lean Manufacturing includes Agile Manufacturing principles and meaning.

### **4.1 Differences between Lean Manufacturing and Industry 4.0**

Lean Manufacturing and Industry 4.0 are particular systems with approximate 30 years difference between their formations so it is logical that distinctions exist. One of them is *different roles of subjects* in processes. Lean Manufacturing processes are based on workers, their collaboration, knowledge, attitude and so on, whereas Industry 4.0 processes bet on smart devices, their sensors, actuators, data exchange etc. The meaning is not to say that Industry 4.0 works without human factor on a shop floor, but basically in advanced stages, routes to it, or at least substitutes a lot of activities done by human in conditions of Lean Manufacturing.

As an example, we can use root cause analysis tools like 5 WHY or Ishikawa. While Lean Manufacturing problem solving processes assign main role to humans who make the analysis or create solving teams, in shape of Industry 4.0 the main role is allocated to machines which

are able to detect failures, wasting or through data sharing determine a root cause and react in real time, or inform production leaders (Geissbauer, Vedsø, & Schrauf, 2016).

Another difference is the *channels of data transfer*. Outputs of Lean Manufacturing processes and tools are often in a paper form. Sometimes this fact makes it more difficult for managers implementing Lean because it could be incorrectly understood by workers as useless papering. In Industry 4.0 a lot of data outputs are automatically transferred into other systems and software thanks to their interconnectivity. Also, the Industry 4.0 environment creates conditions for touchscreens or tablets use. Brau (2016) highlighted that using papers means that data is recorded twice (to a paper and then to a computer) so paperless solutions reduce the cost by half and eliminate about 90% of the typical log errors related with paper data recording.

According to Roser (2018) there is also a *difference of the flexibility* between Lean Manufacturing and Industry 4.0. He argued that Industry 4.0 stands on expensive cyber-physical systems which reduce its flexibility (because each change costs are high) and related speed of changes and continuous improvement, whereas Lean is more flexible in this meaning as its tools support a step by step functioning.

## 4.2 Similarities between Lean Manufacturing and Industry 4.0

If we switch to similarities there is a huge ground for both systems overlap. The first one is the *common goal* – both systems are going to reach an operational excellence. There is more united philosophical contexts as a focus on customer needs (typical for Agile Manufacturing), flexible production, productivity and efficiency increasing or an emphasis on costs reduction. We can see the Industry 4.0 as a new generation of Lean Manufacturing which aims to make processes in the leanest way.

Another similarity is the *way of the implementation* based on human factor where a strong personal management (respectively change management) is needed (Küpper et al., 2017). While some points of view look at the implementation of Industry 4.0 as an implementation of a matured complex of high-tech technologies, others refer that the implementation is not a process “from 0 to 100.” In other words, the implementation of Industry 4.0 is not a one-off handover of processes from human hands to robots, but a gradual shift where smart devices will help to people more and more. That is the reason why the implementation of both systems stands on human factor.

A penetration between both systems could be seen also in *PDCA principle* of process functioning (see Fig. 2). Roser (2017) stated that 70-90% of Lean Manufacturing and Industry 4.0 projects do not bring any measurable benefit due to lack of PDCA.

The both systems have a *common view on safety*. All processes are designed with maximal effort to arrange a safe environment for workers. Lean Manufacturing approach uses signs, check lists, tracking, lessons learned and other tools to manage safety, whereas Industry 4.0 can support them by sensors, automatic alerts or virtual reality training (Küpper et al., 2017).

According to Peitzker (2016), for the both systems is important to have *the same knowledge* of Lean Manufacturing methods. He sees as necessity to achieve the process maturity first (achievable by Lean Manufacturing methods) and then apply Industry 4.0. In practice it is presumable that most of companies will choose the way of step by step application of Industry 4.0 (sometimes based on already implemented Lean Manufacturing) which is conditioned by often interactions between operators and machines (e. g. operators receive real time information and initially their actions are required). The core of Industry 4.0 processes is similar to the Lean ones so the knowledge of Lean Manufacturing principles is important for right collaborations between workers and smart devices in conditions of Industry 4.0.



The relation between Lean Manufacturing and Industry 4.0 is so close that many of authors use *the common name* Lean Industry 4.0 (Brau, 2016; Dingley, 2018; Küpper et al., 2017).

### **4.3 Utilization of Lean Manufacturing methods in Industry 4.0**

Roser (2018) made a quick survey during his presentation at the Lean Manufacturing Conference in Poland. The audience was confronted with six forms of relation between Lean Manufacturing and Industry 4.0. The audience contained Lean Manufacturing specialists as well as other participants interested in Lean. The results were following (Roser, 2018):

- a) A form with no penetration – about 8 people did not see any relation between Lean Manufacturing and Industry 4.0;
- b) A form getting both into a conflict – about 8 people did not believe in possible combination of the systems;
- c) A form of Industry 4.0 as a subset of Lean Manufacturing – massive group of the audience preferred this option;
- d) A form of Lean manufacturing as a subset of Industry 4.0 – it was the most preferable scenario just for one guy in the audience;
- e) A form with overlapping each other – huge part of the audience voted for this scenario where there is a lot of common aspects as well as distinct ones;
- f) A form seeing both as the same – just several persons liked this idea.

The winning forms were the form of Industry 4.0 as a subset of Lean Manufacturing and the form with overlapping each other (the author preferred the second variant). This result could be seen as an effort to connect both systems or in other words to utilize the Lean Manufacturing in the new industrial revolution.

As was mentioned, the both systems have a lot of similar signs and there is a lot of areas where utilization of Lean Manufacturing methods in conditions of Industry 4.0 is efficient or even necessary. As a base for further focus we can demonstrate following tools as examples:

- a) SMED – Industry 4.0 stands on maximal flexibility of production which allows mass customization. It means that a lot of kinds of product are produced which is conditioned by very fast changeovers. The smart devices arrangement of Industry 4.0 production line should be constructed with taking in account of SMED method (Mrugalska & Wyrwicka, 2017). Thanks to cyber-physical systems a lot of activities can be moved from internal elements to external ones or completely eliminated which opens a new level of SMED efficiency;
- b) 5S – this elementary tool has a positive impact in every production system as the systematic maintaining increases a process efficiency;
- c) Maintenance tools – smart devices include self-detecting systems of its parts wear. This could move some parts of preventive maintenance to predictive one (Cousineau, 2019). However, the smart devices are still machines, so principles of preventive, predictive and unplanned maintenance are usable;
- d) Kaizen cards – in the Lean Manufacturing world they are fulfilled by workers who in name of Kaizen environment search for ways of improvement. Industry 4.0 includes this idea onto cyber-physical level where smart devices are able to work with data and propose possible improvements or even do them automatically (Mrugalska & Wyrwicka, 2017);

- e) VSM – Value Stream Mapping main element is the visualization. Tamás & Illés (2016) highlighted that this tool can be used in conditions of Industry 4.0 to reduce wastes and lead times. Even higher efficiency is ensured by the fact that the visualization can be done on cyber level. The developed system is called VSM 4.0 (Meudt, Metternich, & Abele, 2017);
- f) Logistic methods (JIT, FIFO) – Brau (2016) saw an opportunity in Industry 4.0 to support advanced FIFO tools through smart touchscreens which helps to check if batch numbers correspond with FIFO. Flexible production and reduction of inventory is related to JIT and Kanban system. Smart devices are able to control the logistic flow of product via sensors and data interactions which can be a base for a new level of JIT and new kinds of Kanban;
- g) Poka Yoke – BCG analysis shows that self-inspections reduce the number of defects by 50-70% (Küpper et al., 2017). Industry 4.0 creates a place for Poka Yoke expansion thanks to sensors and robots use. A magnitude of Red Rabbits using will be kept to control the machines.

The potential utilization of the mentioned tools and methods together with others as Pull System, One Piece Flow, Takt Time, Visual Management, 3M, Heijunka, Hoshin Kanri, Gemba, Jidoka, Andon, 8D, 5WHY or Ishikawa in conditions of Industry 4.0 will be part of a further research.

## 5 RESULTS

This paper summarized basics of Lean and Agile Manufacturing and Industry 4.0 and found coherences between these systems. Also differences as different roles of process subjects, channels of data transfer and the difference of the flexibility were defined as well as similarities like the common goal, ways of its implementations, PDCA principle, the common view on safety or the knowledge base. The paper described possible utilization of Lean Manufacturing tools in conditions of Industry 4.0.

The common relation was defined from different points of views. The paper showed that Lean Manufacturing methods and tools are widely usable in conditions of Industry 4.0. The possible uses were demonstrated on concrete Lean Manufacturing tools as SMED, 5S, maintenance tools, Kaizen cards, VSM, JIT, FIFO or Poka Yoke.

The fact that there is a huge theoretical background already existing which play an important role in Industry 4.0 can be also considered as an important result. However, there are open areas for further theoretical and practical research, development and studying of the new incoming industrial revolution environment and its ways of implementation.

The further activities will be focused on a practical research in Czech companies of different sizes and from different business fields. The investigation will be directed to an influence of the business fields specifics, company sizes and their existing experiences with Lean and Agile Management principles and methods on the implementation of Industry 4.0 principles and tools.

## 6 CONCLUSION

The paper has shown that the relation between Lean/Agile Manufacturing and Industry 4.0 provides a wide possibility for research activities. The paper found just the main penetrations between the approaches and outlined the utilization of the several Lean Manufacturing tools only as the extent needed for the complete research exceed the scope of the paper.

Though there is the huge theoretical background, a systematic and complete theoretical approach to the utilization of the Lean and Agile Manufacturing methods in conditions of Industry 4.0 should be constructed and their relation should be exactly defined under the specifics of different business environments. It requires further theoretical and practical research. In this way, a general pillar for practical utilization can be created.

Within the different sources there is a general agreement confirming the relation between the existing production systems and incoming Industry 4.0. Many of authors (Cousineau, 2019; Meudt, Metternich, & Abele, 2017; Mrugalska & Wyrwicka, 2017; Tamás & Illés, 2016) point their researches to concrete areas (maintenance tools, VSM, logistic tools, ...) of the relation between Lean Manufacturing and Industry 4.0, which could create a strong base for creation of a systematic approach to increasing Industry 4.0 implementation efficiency.

The crucial aspect of the successful implementation of Industry 4.0 will be a knowledge of an utilization of existing production management approaches which particular companies have been already using. The knowledge should contain information about impacts of particular business environments on the most effective way of the implementation. This will be a part of next research activities.

The incoming new industrial revolution is a discussed topic in a current business field. It exposes companies to face new challenges. From a global view, mass customization and personalization open new possibilities and opportunities of the current economic system and create a space for massive integration of companies.

Ways of implementation of Industry 4.0 using existing manufacturing structure and principles is the key precondition for successful transformation into the environment of new market requirements. A successfully managed transformation could be also a way how to increase financial profit and beat competition. A development of theoretical base of the connection of Lean Manufacturing and Industry 4.0 issues is desirable.

## **Acknowledgement**

This paper was elaborated in the frame of the specific research project SP2019/62, which has been solved at the Faculty of Materials Science and Technology, VŠB-TU Ostrava with support of Ministry of Education, Youth and Sports, Czech Republic.

## **References**

- Brau, S. J. (2016). *Lean Manufacturing 4.0: The technological evolution of Lean*. Boca Raton: American Lean SD.
- Brettel, M., Friederichsen, N., Keller, M., & Rosenberg, M. (2014). How virtualization, decentralization and network building change the manufacturing landscape: An Industry 4.0 perspective. *World Academy of Science, Engineering and Technology, International Journal of Information and Communication Engineering*, 8(1). Retrieved from <https://pdfs.semanticscholar.org/2583/9292e6c78a4f9389e3a4e5063862fa79b322.pdf>
- Cousineau, M. (2019). *A practical guide to Industry 4.0 and maintenance*. Retrieved from <https://www.fiixsoftware.com/blog/industry-4-maintenance/>
- Dingley, M. (2018). *Lean manufacturing Industry 4.0: The next level of operational excellence?* Retrieved from <https://blog.matthews.com.au/lean-manufacturing-industry-4-0-the-next-level-of-operational-excellence/>

- Fisher, M. (1991). *The millionaires book of quotations*. London: Thorsons.
- Fountain, M. (2017). *The comprehensive guide to Agile Manufacturing*. Retrieved from [www.sageautomation.com/blog/the-comprehensive-guide-to-agile-manufacturing](http://www.sageautomation.com/blog/the-comprehensive-guide-to-agile-manufacturing)
- Geissbauer, R., Vedsø, J., & Schrauf, S. (2016). *A strategist's guide to Industry 4.0*. Retrieved from <https://www.strategy-business.com/article/A-Strategists-Guide-to-Industry-4.0>
- Gunasekaran, A., Yusuf, Y. Y., Papadopoulos, T., Adeleye, E. O., Kovvuri, D., & Geyi, D. G. (2018). Agile Manufacturing: An evolutionary review of practices. *International Journal of Production Research*, 7, 5154-5174. doi: 10.1080/00207543.2018.1530478
- Kagermann, H., Anderl, R., Gausemeier, J., Schuh, G., & Wahlster, W. (2016). *Industrie 4.0 in a global context: Strategies for cooperating with international partners*. Retrieved from [https://www.researchgate.net/publication/315739153\\_Industrie\\_40\\_in\\_a\\_Global\\_Context\\_Strategies\\_for\\_Cooperating\\_with\\_International\\_Partners\\_acatech\\_STUDY](https://www.researchgate.net/publication/315739153_Industrie_40_in_a_Global_Context_Strategies_for_Cooperating_with_International_Partners_acatech_STUDY)
- Küpper, D., Heidemann, A., Ströhle, J., Spindelndreier, D., & Knizek, C. (2017). *When Lean meets Industry 4.0: The next level of operational excellence*. Retrieved from <https://www.bcg.com/publications/2017/lean-meets-industry-4.0.aspx>
- Leyh, C., Martin, S., & Schäffer, T. (2017). Industry 4.0 and Lean production – A matching relationship? An analysis of selected Industry 4.0 models. *2017 Federated Conference on Computer Science and Information Systems*, 11, 989-993. doi: 10.15439/2017f365
- Mařík Vladimír. (2016). *Průmysl 4.0: výzva pro Českou republiku*. Prague: Management Press.
- Marsh, P. (2013). *The new industrial revolution: consumers, globalization and the end of mass production*. New Haven: Yale University Press.
- Meudt, T., Metternich, J., & Abele, E. (2017). Value stream mapping 4.0: Holistic examination of value stream and information logistics in production. *CIRP Annals*, 66(1), 413-416. doi: 10.1016/j.cirp.2017.04.005
- Mrugalska, B., & Wyrwicka, M. K. (2017). Towards Lean production in Industry 4.0. *Procedia Engineering*, 182, 466-473. doi: 10.1016/j.proeng.2017.03.135
- Peitzker, S. (2016). *Lean production meets Industry 4.0*. Retrieved from <https://blog.bosch-si.com/industry40/lean-meets-industry-4-0/>
- Reis, J. Z., & Gonçalves, R. F. (2018). The role of Internet of Services (IoS) on Industry 4.0 through the Service Oriented Architecture (SOA). *Advances in Production Management Systems. Smart Manufacturing for Industry 4.0*, 536, 20-26. doi: 10.1007/978-3-319-99707-0\_3
- Roser, C. (2018). *Lean and Industry 4.0*. Retrieved from <https://www.allaboutlean.com/lean-and-industry-4-0/>
- Schumacher, A., Sihn, W., & Erol, S. (2016). *Automation, digitization and digitalization and their implications for manufacturing processes*. Paper presented at Innovation and Sustainability International scientific Conference Bucharest, Romania. Retrieved from [https://www.researchgate.net/publication/318877006\\_Automation\\_digitization\\_and\\_digitalization\\_and\\_their\\_implications\\_for\\_manufacturing\\_processes](https://www.researchgate.net/publication/318877006_Automation_digitization_and_digitalization_and_their_implications_for_manufacturing_processes)
- Shyuac, J., Kuo, C.-C., & Ding, K. (2019). Industrial revitalization via industry 4.0 – A comparative policy analysis among China, Germany and the USA. *Global Transitions*, 1, 3-14. doi: 10.1016/j.glt.2018.12.001

- Tamás, P., & Illés, B. (2016). Process improvement trends for manufacturing systems in Industry 4.0. *Academic Journal of Manufacturing Engineering*, 14(4), 119-125. Retrieved from [https://www.researchgate.net/profile/Peter\\_Tamas6/publication/313359291\\_PROCESS\\_IMPROVEMENT\\_TRENDS\\_FOR\\_MANUFACTURING\\_SYSTEMS\\_IN\\_INDUSTRY\\_40/links/58973c60a6fdcc32dbdbdda7/PROCESS-IMPROVEMENT-TRENDS-FOR-MANUFACTURING-SYSTEMS-IN-INDUSTRY-40.pdf](https://www.researchgate.net/profile/Peter_Tamas6/publication/313359291_PROCESS_IMPROVEMENT_TRENDS_FOR_MANUFACTURING_SYSTEMS_IN_INDUSTRY_40/links/58973c60a6fdcc32dbdbdda7/PROCESS-IMPROVEMENT-TRENDS-FOR-MANUFACTURING-SYSTEMS-IN-INDUSTRY-40.pdf)
- Yao, X., & Lin, Y. (2015). Emerging manufacturing paradigm shifts for the incoming industrial revolution. *The International Journal of Advanced Manufacturing Technology*, 85, 1665-1676. doi: 10.1007/s00170-015-8076-0
- Žák, Č., & Zajíc, D. (2017). ERP systémy v éře Průmyslu 4.0: Automatizace, zjednodušování a podpora internetu věcí. Retrieved from [https://ictrevue.ihned.cz/c3-65678510-0ICT00\\_d-65678510-erp-systemy-v-ere-prumyslu-4-0-automatizace-zjednodusovani-a-podpora-internetu-veci](https://ictrevue.ihned.cz/c3-65678510-0ICT00_d-65678510-erp-systemy-v-ere-prumyslu-4-0-automatizace-zjednodusovani-a-podpora-internetu-veci)

### Contact information

#### **Ing. Mikuláš Hurta**

VŠB – Technical University of Ostrava, Faculty of Materials Science and Technology  
17. listopadu 15, 70833, Ostrava, Czech Republic  
E-mail: m.hurta737@centrum.cz  
ORCID: 0000-0001-5792-9855

#### **prof. Ing. Darja Noskievičová, CSc.**

VŠB – Technical University of Ostrava, Faculty of Materials Science and Technology  
17. listopadu 15, 70833, Ostrava, Czech Republic  
E-mail: darja.noskievicova@vsb.cz  
ORCID: 0000-0002-1154-712X

doi: 10.7441/dokbat.2019.039

# THE EFFECT OF SOCIAL MEDIA MARKETING ACTIVITIES ON CUSTOMER BEHAVIOUR

*Romina Cheraghizadeh*

## **Abstract**

In last few decades, people are more conscious about usage of social media. It has become one of the most important elements of individuals' routine life, and this makes it to be an essential requirement for companies. It has pushed companies to deal with social media activities to meet customers' needs. Existing literature on social media highlighted this importance in various fields; however, there are still limited studies considering on customers satisfaction and loyalty as consequences of social media marketing activities. This study tries to explain the importance of social media marketing activities in enhancing customer satisfaction and loyalty by reviewing the existing literature in this regard. Further, this study highlighted two aspects of loyalty named intention to return and positive word of mouth to give a better view about this dimension. That is, this study showed how social media marketing activities improve the company-customer relationships, and affect positively on customers behavioural intentions which are here customer satisfaction, positive word of mouth and intention to return. This study contributes to have deeper understanding about importance of social media marketing activities on customers' behavioural outcomes, and tries to clarify the main points in brief. In the end, research limitation and cues for further research have been pointed.

*Keywords: Social media marketing activities; customer satisfaction, intention to return, positive word of mouth*

## **1 INTRODUCTION**

As competition among companies enhanced in last decades, managers strongly consider on their customers' behaviours. Many firms try to create and improve customer satisfaction and loyalty programs to keep their customers; and prevent them to switch to competitors. Satisfied and loyal customers enable companies to generate higher profit, increase purchase level, reduce operation cost, and enhance profit margin (Zakaria et al. 2014).

On the other hand, internet has changed the traditional form of human interactions; and expanded different forms of applications and media over time. This suggests organizations to apply social media marketing to meet customers' needs towards social media. The real-time actions by users facilitate sharing information and contacts between people. It is affordable and convenient for customers, led many organizations to apply social media in wider range (Seo & Park, 2018). Establishment of websites created large social communities; and enhanced satisfaction of community members.

Even in service industries, leaders understood the importance of social media and cannot ignore its effect on their businesses. Most of companies are dependent on good reviews and word of mouth from their loyal customers, which makes social media a marketing and branding tool for them. Therefore, companies need to consider on their social media activities as a tool to have satisfied and loyal customers.

## **1.1 Research Contribution**

Despite the high importance of social media marketing; and the numbers of researches in different fields, there are limited studies focusing the benefits of social media marketing activities on customers' satisfaction and loyalty. Empirical studies about social media have shed significant insights on perception of users towards websites and their features in airlines, insurance industry, luxury brands etc (e.g. Godey et al., 2016; Sano, 2015; Seo & Park, 2018). However, despite the efforts have been done in the literature to understand the importance of social media on customer loyalty (e.g. Nisar & Whitehead, 2016; Balakrishnan et al., 2014); studies more concerned about loyalty as general variable (Erdoğan & Çiçek, 2012; Lee et al., 2018; Yoshida et al., 2018). And studies considered to dimensions of loyalty mostly considered on purchase intention. Therefore, there are limited studies considered the connection of social media marketing activities and on aspects of loyalty and especially the dimension of word of mouth. (e.g. Godey et al., 2016). This research reviews the existing studies in social media considering their effects on customer behaviour.

## **1.2 Purpose of Research**

Social media is undergoing a quick change; and this study tries to understand customers' behaviour by considering specific social media marketing factors. Social media is used to meet professional and personal needs, and this research explores social media marketing activities as drivers of users' satisfaction and loyalty (Rauniar et al., 2013). Loyalty has been also considered with its two dimensions named positive word of mouth and intention to return to give a deeper view about how consumers behave responding to social media in terms of loyalty.

## **2 RESEARCH METHODOLOGY**

This study is based on reviewing the existing literature, which are related to social media marketing in terms of customer responses. Social media marketing is a wide field, which is difficult to be restricted to few particular area and disciplines. Indeed, this difficulty occurs since industry fields and sciences involved are multidisciplinary and wide in their nature (Misirlis & Vlachopoulou, 2018). Articles, which considered technically into social media such as implementing and improving the relative technical system have been disregarded (eg. Ducange et al., 2019; Ozbay & Alatas, 2019) to deal with literature that is more relevant. Furthermore, there are literature considered on company-related side of social media such as performance and motivation of employees in dealing with social media (e.g. Eagleman, 2013; Korzynski et al., 2019; Song et al., 2019); and these researches are also disregarded. We tried to consider on researched focusing on customer responses dealing with social media. Not specifically the only ones considered exactly on customer satisfaction and loyalty but connected to these variables.

## **3 WHAT IS THE EFFECT OF SOCIAL MEDIA MARKETING ACTIVITIES ON CUSTOMERS SATISFACTION AND LOYALTY**

### **3.1 Social Media Marketing Activities**

Social media marketing is defined as commercial marketing processes that use social media to positively influence consumers' purchase behaviour (Dann, 2010). Social media marketing takes variety of forms, including weblogs, social blogs, microblogging, wikis, podcasts, pictures, video, rating and social bookmarking. As application of social media is raising, companies are increasingly using them as communication tools.

Companies organize marketing activities according to different users' needs; they need to understand users' demands earlier than the users themselves and learn which products or services they need in order to impress them (Kim & Perdue, 2013). According to Kim and Ko (2010), social media can have a dramatic influence on a brand's reputation. The report states that companies which are not engaging in social media as part of their online marketing strategy are missing an opportunity to reach consumers. It is not surprising if companies do not meet what customers demand, will not have satisfied customers and will fail in their businesses.

Furthermore, the components of social media have been addressed in studies with various authors and settings. Kim and Ko (2012) classified social media marketing activities characteristics into entertainment, interaction, trendiness, customization, and word of mouth, and their applications in luxury brands. Sano (2015) applied interaction, trendiness, customization, and perceived risk as the four social media marketing activities components in insurance services. However, Seo and Park (2018) considered entertainment, interaction, trendiness, customization, and perceived risk as social media marketing characteristics in airlines. These aspects give better understanding about why social media bring positive behavioural intention of customers.

Entertainment is result of fun and joy acquired through social media (Seo & Park, 2018). It is significant component in social media that induces positive emotions, increases participating behaviour, and generates intention to use continuously. Given that social media is a space for consumers to discuss and exchange ideas, interactions offer insights to users who contribute to social media platforms with respect to particular brands. These users meet and interact with one another in cyberspace and discuss about specific products and brands (Muntinga et al., 2011). Consumers tend to trust information acquired through social media more than from advertisements in marketing activities or promotions (Seo & Park, 2018). Trendiness, accordingly, is defined as providing the newest information about products or services (Bruno et al., 2016) which social media enabled users to acquire them easily. Further, the level of customization represents the extent to which a service reflects the demands of customers to satisfy their tastes (Schmenner, 1986). Customization in social media is based on contact with individual users, which is a major difference with conventional advertising media. It is possible to provide individually optimized information generated by various sources to customers, and this customization is used as a strategy to generate positive perceived control and customer satisfaction (Ding & Keh, 2016). The customization of social media is also a tool for companies to communicate the uniqueness of their brands and improve preferences and loyalty to those brands (Martin & Todorov, 2010). Further, perceived risk is considered as consequence of uncertainties related to consumer behaviour. It is selected as a social media marketing activities component because of its ability to alleviate the anxiety or concern perceived by consumers. That is, consumers face lesser risk of making mistakes or getting regret while making decisions when they use social media.

### **3.2 Customer Satisfaction**

Consumer satisfaction is an individual's favourable evaluation of any experience or outcome regarding to consuming a product or using a service (Maxham, 2001; Westbrook, 1980). It is the consumer's response; based on judgment that a service or product, or its feature, can bring a level of fulfilment.

Chen and Lin (2019) tested a model, showing that social media marketing activities effect on satisfaction; and it can be also through mediating role of social identification and perceived value. They mentioned the benefits of social media include transmitting information as well as tracking demands, customer service, and managing the community. These can enhance customer satisfaction and also improve their rights. Verhagen et al. (2011) indicated that while



dealing with online transactions, users have higher level of satisfaction with the website if they have a high enjoyable experience.

Emotions have important effect on users' behaviour. The entertainment and convenience that social media brings, enhance users' intention to apply them. Also, individuals are more likely to use social media because they find them amusing or fun (Wang & Fesenmaier, 2004).

Buttle (2006) indicated that satisfaction is a pleasurable; however, dissatisfaction is unpleasurable fulfilment response. Moreover, satisfaction is a positive and affective behaviour resulting from the appraisal of association with individuals or companies. Meanwhile, in business field, as the organization holds a positive connection with its customers, several desirable outcomes are more likely to happen (Zakaria et al., 2014).

Schiffman et al. (2010) mentioned that customer satisfaction is connected to a particular concern (such as service or product itself, or purchase experience); and also, in a certain time (such as post-consumption or post-purchase). This view supports that the level of customer satisfaction is identified as cumulative experience.

Chen and Li (2019) investigated how social media marketing affects three types of intention named continuance intention, purchase intention and participate intention; and how social identification, perceived value and satisfaction mediate these relationships. They indicated that users improve self-affirmation and self-esteem by sorting, identifying and comparing. In addition, they experience enjoyment and pleasure which is an essential motivator for users.

Individuals using social media raise various demands, which make difference in their motivations, and actions. In addition, while interacting with social media, various emotions are expanded, and affect users' satisfaction. Positive emotions such as pleasure and enjoyment and negative emotions, such as anxiety and anger decrease. Positive emotions enhance individuals' satisfaction, however negative emotions in turn decrease (Kuo & Wu, 2012).

In sum, customer satisfaction is considered as a cumulative experience in a period of time. Social media activities give convenience and pleasure to users, which stimulate the level of their satisfaction. Conversely, lesser connection and information towards a product or service enhance the level of anger and anxiety, which enhance dissatisfaction among consumers.

### **3.3 Word of Mouth**

Word of mouth is a powerful marketing instrument (Subramanian, 2018). It is communication between consumers, and consists comments about services and products (Arndt, 1967). Consumer behaviour can be influenced by various types of advertising; however, word of mouth has a stronger effect than other types such as radio and written advertisements (Engel et al., 1969).

Word of mouth is non-commercial comments and messages regarding to products, services, or brands receiving from users and not providers (Arndt, 1967). It is an effective way to decrease perceived risk about the services or products information. That is, people count on these comments more than other commercial sources and any other types of advertisements. They are more likely to trust the opinions of their peers than advertisements, which come directly from the service providers. According to Trusov et al. (2009), traditional form of getting information becomes less efficient due to reliability issues. Social media gives this opportunity to customers to communicate with other users and receive their opinion about service or product.

Muntinga et al. (2011) showed that word of mouth has stronger empathy, credibility, as well as relevance for users comparing to company created sources. Social media is the proper tools for

word of mouth, since users generate and spread relevant information to their peers, friends, and other users (Godey et al., 2016).

Seo and Park (2018) believe that brand equity can be considered as positive antecedent of consumer confidence index. That is, social media marketing activities are associated to customers' word of mouth and it is through the mediation role of brand equity.

Chu and Kim (2011) examined the use of word of mouth in regards of social media with three aspects: seeking for opinion, giving opinion, and passing opinion. Users tend to look for advice and information from other consumers while making their purchase decision. Users with a higher level of giving opinion, have important effect on other consumers' behaviours and attitudes (Godey et al., 2016).

Communication in social media strongly affect brand image (Godey et al., 2016). Keller (1993) mentioned that brand image is the perceptions towards a brand, which the brand connections in users' memory reflect.

Positive word of mouth lead to attain new clients, improve branding, shorter transaction cycle, and more customer information regarding to services and products. Furthermore, communication seems to be more personalized and uncontrollable compared with last years; due to the unpredictable reactions of customers. Placing a customer-oriented business to gain positive comments and messages is the key point for companies to the marketing efforts. (Subramanian, 2018).

In sum, social media activities enable users to have easier access to the brand information as well as comments and reviews of their peers; and therefore, affect their decision-making. People are more likely to accept comments of other users than the direct advertisement from service provider. Therefore, loyal customers can be considered as an asset for companies due to their positive comments to potential customers.

### **3.4 Intention to Return**

Revisit intension, is another dimension of loyalty. It can be described as consumer intention to experience the same place, product, region, or brand in the future (Zeithaml et al., 1996). Spreng et al., (1995) indicated that cost of maintaining existing customers is fairly lesser than prospecting new customers. Some scholars have found that companies can recover from their failure; and retain customers' intention to repurchase from them in the future (Maxham, 2001).

Social media plays a role when the marketing activities of a company establish an individual relationship with customers and provide companies with opportunities to access customers (Kelly et al., 2010). It can make customers more committed to the brand, as commitment is an internal psychological state perceived as a continuous desire to maintain a relationship. Therefore, customers may show the tendency to return to the same brand.

Social media impacts brand awareness; which is connected to strengthen of the brand tie, or to keep the brand in memory (Godey et al. 2016); and according to literature, brand awareness is considered as antecedent of customer satisfaction and loyalty (Bilgili & Ozkul, 2015).

Sozer (2019) discussed about effect of social media on users switching intention; and mentioned when users engage into connections with brands, the primary motivation is to achieve the expected value from this connection. The association between the customer and brand led to the dissolution stage while they do not meet the expected value from the provider. At this level, customers' intention to switch the current brand enhances. Factors may affect switching intention contain poor service or product performance, negative value regarding to money evaluations, and alternative attractiveness. When customers' readiness towards switching the

brand enhances, social media turns to be an effective source of information to find and assess the alternatives.

In hospitality and hotel industry literature, among several outcomes of travellers' involvement, intention to revisit is one of the most critical consequences, which many researches have considered (Leung & Bai, 2013). For instance, Kim et al. (2009) revealed that travellers' involvement has a positive effect on their revisit intention to the same destinations and it is through the mediation role of brand equity and satisfaction. Furthermore, Lee and Beeler (2009) mentioned that individuals' involvement along with motivation and service quality lead to revisit intention to local festival. Scholars have also found that travellers' involvement in social media can lead to their attitudes and behaviours such as loyalty (Kim, 2008), and revisit intention (Wang & Wu, 2011).

According to Seo and Park (2018) social media marketing activities affect brand awareness which is consumer ability to memorize and identify a brand in various situation (Rossiter and Percy, 1987). That is, customer already knows the name of brand, and this enhances the chance of brand being included in a list of potential choices, and increases the possibility of brand being selected.

Several studies have also argued that purchase intention is directly affected by customer satisfaction (LaBarbera & Mazursky, 1983) and companies can preserve customer retention by solving service failures in a fair way (Oliver Swan, 1989).

In sum, social media can keep the connection of users with company by updating them about new services or products, new offers, providing information about customer satisfaction and performance, etc. Therefore, these can encourage customers to show loyalty and stimulate intention to revisit positively.

## **4 CONCLUSION**

### **4.1 Brief Summary of Literature**

Positive effects of social media marketing activities are not only limited to customers; and companies also benefit from them. This study tried to focus on customer side, and discuss how social media marketing activities positively affect customer behavioural intentions.

According to Misirlis & Vlachopoulou (2018) social media marketing researches in field of marketing contain seven main objectives such as brand awareness, engagement, eWOM advertising, predictive marketing research, consumer behaviour research, social capital, and relationship marketing. We have considered on aspects, which involve customers as main part.

Brand awareness, deals with the presenting brand image and content to the potential audience (Misirlis & Vlachopoulou). When brand community is created between the different types of communities and based on social relationships with users, it leads to community awareness. Accordingly, individuals in the community can expand and spread knowledge towards brand; and further, learn from other users' assessments towards service or products, and these effect on others ideas (Chen & Lin, 2019).

Furthermore, customers have more access to updated information in lesser time, and can receive comments and information from other users, which they find more trustable. Such activities improve brands awareness, which give more options to customers to choose among, and compare the alternatives. Engagement also creates further actions, which takes into consideration regarding to brand content.

Promotion and advertising have been considered as important objectives associated with social media, creating valuable information, which makes users impressed and satisfied and in turn, estimate the purchase potential. They can further customize the information they are looking for and disregard the ones they find irrelative and save their time.

Using social media is more convenient than tradition form of marketing; and enable customers to have easier interaction with companies and other customers. It gives them the quicker access to information, and provide information, as well as communicate with other potential users.

Entertainment is also considered as a strong motive for using social media. Using social media has combined with joy and fun; and it satisfies users as they are pleasure seekers. It is also more relaxing and gives customers feel of amusement while using social media.

Using social media helps customer to save their time. The process is faster in decision-making process, purchase, and post-purchase benefits. Process is also cost-effective.

Social media deal with the latest information and news as well as hot topics. Consumers also look into social media as they perceive them more trustworthy source than company-sponsored communication in traditional marketing activities.

Moreover, decisions are lesser risky comparing with old methods of marketing. Customers are able to review information provided by company as well as the comments of other users about services or products. They have wider information in shorter time to make their decisions.

They also have more opportunity to evaluate different brands, compare them, and choose the one, which gives them more satisfaction regarding to what they demand. These reduce the anxiety and regret after making decision, and bring loyalty.

#### **4.2 Limitation and Suggestion for Further Research**

This article reviews the existing literature about importance of social media marketing activities and their effect of customer satisfaction and loyalty; however, individuals' perception regarding to goods and services are not always the same based on what they demand. Customers might be cost-sensitive which makes a big difference with the ones who are quality-sensitive. Therefore, we suggest potential researchers to concern about this issue in future researches; and differ among customers in this matter. Also, behaviour of customers in different industries might not be the same. For instance, while using products, if customers are satisfied with the quality of goods (also considering the price they pay), they may show loyalty behaviour; however, this may not be the same about services. For instance, in hotel industry which customers might be happy with the services they experienced; however, they may prefer to try other hotels in their next trips to experience something different. Therefore, we suggest researchers to distinguish between industries and compare customers' behaviour in different fields. Also, researchers can consider on dimension of alternative attractiveness which may affect customers' behaviour while making decision. Since customers may think of the potential alternative brands which may give them higher level of satisfaction by offering the same price.

#### **References**

- Arndt, J. (1967). Role of product related conversations in the diffusion of a new product. *Journal of Marketing Research*, 4, 291-295. doi: 10.1177/002224376700400308
- Balakrishnan, B., Dahni, M. I., & Yi, W. J. (2014). The Impact of Social Media Marketing Medium toward Purchase Intention and Brand Loyalty among Generation Y. *Procedia - Social and Behavioral Sciences*, 148(25), 177-185. doi: 10.1016/j.sbspro.2014.07.032

- Bigne, J.E., Sanchez, M.I., & Sanchez, J. (2001). Tourism image, evaluation variables and after purchase behaviour: Inter-relationships. *Tourism Management*, 22(6), 607-616. doi: 10.1016/S0261-5177(01)00035-8
- Bilgili, B., Ozkul, E. (2015). Brand awareness, brand personality, brand loyalty and consumer satisfaction relations in brand positioning strategies (A Torku brand sample). *Journal of Global Strategic Management*, 9(2), 89-106. doi: 10.20460/JGSM.2015915576
- Bitner, M. J. (1990). Evaluating service encounters: the effects of physical surroundings and employee responses. *Journal of Marketing*, 52(2), 69-82. doi: 10.1177/002224299005400206
- Bruno, G., Aikaterini, M., Daniele, P., Joonas, R., Gaetano, A., Raffaele, D., & Rahul, S. (2016). Social media marketing efforts of luxury brands: influence on brand equity and consumer behavior. *Journal of Business Research*, 69(12), 5833-5841. doi: 10.1016/j.jbusres.2016.04.181
- Buttle, F. (2006). *Customer Relationship Management: Concept and Tools*. Oxford: Elsevier.
- Chen, S. & Li, C. (2019). Understanding the effect of social media marketing activities: The mediation of social identification, perceived value, and satisfaction. *Technological Forecasting and Social Change*, 140, 22-32. doi: 10.1016/j.techfore.2018.11.025
- Cronin, J.J., Taylor, S.A. (1992). Measuring service quality: a reexamination and extension. *Journal of Marketing*, 56(3), 55-68. doi: 10.1177/002224299205600304
- Dann, S., 2010. Redefining social marketing with contemporary commercial marketing definitions. *Journal of Business Research*, 63(2), 147-153. doi: 10.1016/j.jbusres.2009.02.013
- Ding, Y., & Keh, H.T. (2016). A re-examination of service standardization versus customization from consumer's perspective. *Journal of Services Marketing*, 30(1), 16-28. doi: 10.1108/JSM-02-2015-0088
- Ducange, P., Fazzolari, M., Petrocchi, M., & Vecchio, M. (2019). An effective Decision Support System for social media listening based on cross-source sentiment analysis models. *Engineering Applications of Artificial Intelligence*, 78, 71-85. doi: 10.1016/j.engappai.2018.10.014
- Eagleman, A. N. (2013). Acceptance, motivations, and usage of social media as a marketing communications tool amongst employees of sport national governing bodies. *Sport Management Review*, 16(4), 488-497. doi: doi.org/10.1016/j.smr.2013.03.004
- Engel, J.E., Blackwell, R.D. & Kegerreis, R.J. (1969). How information is used to adopt an innovation. *Journal of Advertising Research*, 9, 3-8. Retrieved from <https://www.econbiz.de/Record/how-information-is-used-to-adopt-an-innovation-engel-james/10002119670>
- Erdoğan, I. E., & Çiçek, M. (2012). The Impact of Social Media Marketing on Brand Loyalty. *Procedia - Social and Behavioral Sciences*, 58, 1353-1360. doi: 10.1016/j.sbspro.2012.09.1119
- Godey, B., Manthiou, A., Pederzoli, D., Rokka, J., Aiello, G., Donvito, R., & Singh, R. (2016). Social media marketing efforts of luxury brands: Influence on brand equity and consumer behavior. *Journal of Business Research*, 69(12), 5833-5841. doi: 10.1016/j.jbusres.2016.04.181

- Kaplan, A.M., & Haenlein, M. (2010). Users of the world, unite! The challenges and opportunities of social media. *Business Horizons*, 53(1), 59-68. doi: 10.1016/j.bushor.2009.09.003
- Kim, A. J., & Ko, E. (2010). Impacts of luxury fashion brand's social media marketing on customer relationship and purchase intention. *Journal of Global Fashion Marketing*, 1(3), 164-71. doi: 10.1080/20932685.2010.10593068
- Kim, A. J., & Ko, E. (2012). Do social media marketing activities enhance customer equity? An empirical study of luxury fashion brand. *Journal of Business Research*, 65, 1480-1486. doi: 10.1016/j.jbusres.2011.10.014
- Kim, D., & Perdue, R.R. (2013). The effects of cognitive, affective, and sensory attributes on hotel choice. *International Journal of Hospitality Management*, 35, 246-257. doi: 10.1016/j.ijhm.2013.05.012
- Kim, K. (2008). Analysis of structural equation model for the student pleasure travel market: Motivation, involvement, satisfaction, and destination loyalty. *Journal of Travel & Tourism Marketing*, 24(4), 297-313. doi: 10.1080/10548400802156802
- Kim, S.H., Holland, S., & Han, H.S. (2013). A structural model for examining how destination image, perceived value, and service quality affect destination loyalty: A case study of Orlando. *International Journal of Tourism Research*, 15(4), 313-328. doi: 10.1002/jtr.1877
- Kim, S., Han, H., Holland, S., & Byon, K. K. (2009). Structural relationships among involvement, destination brand equity, satisfaction and destination visit intentions: The case of Japanese outbound travelers. *Journal of Vacation Marketing*, 15(4), 349-365. doi: 10.1177/1356766709335835
- Korzynski, P., Mazurek, G., & Haenlein, M. (2019). Leveraging employees as spokespeople in your HR strategy: How company- related employee posts on social media can help firms to attract new talent. *European Management Journal*. doi: 10.1016/j.emj.2019.08.003
- Kuo, Y.-F., & Wu, C.-M. (2012). Satisfaction and post-purchase intentions with service recovery of online shopping websites: Perspectives on perceived justice and emotions. *International Journal of Information Management*, 32, 127-138. doi: 10.1016/j.ijinfomgt.2011.09.001
- Labarbera, P.A., & Mazursky, D. (1983). A longitudinal assessment of customer satisfaction/dissatisfaction: the dynamic aspect of the cognitive process. *Journal of Marketing Research*, 20, 393-404. doi: 10.1177/002224378302000406
- Lee, C. K. M., Ng, K. K. H., Chan, H. K., Choy, K. L., Tai, W. C., & Choi, L. S. (2018). A multi-group analysis of social media engagement and loyalty constructs between full-service and low-cost carriers in Hong Kong. *Journal of Air Transport Management*, 73, 46-57. doi: 10.1016/j.jairtraman.2018.08.009
- Lee, J., & Beeler, C. (2009). An investigation of predictors of satisfaction and future intention: Links to motivation, involvement, and service quality in a local festival. *Event Management*, 13, 17-29. doi: 10.3727/152599509789130584
- Leung, X.Y. & Bai, B. (2013). How Motivation, Opportunity, and Ability Impact Travelers' Social Media Involvement and Revisit Intention. *Journal of Travel & Tourism Marketing*, 30(1-2), 58-77. doi: 10.1080/10548408.2013.751211
- Mattila, A.S. (2001). Emotional bonding and restaurant loyalty. *The Cornell Hotel and Restaurant Administration Quarterly*, 42(6), 73-79. doi: 10.1177/0010880401426009

- Martin, K., & Todorov, I. (2010). How will digital platforms be harnessed in 2010, and how will they change the way people interact with brands? *Journal of Interactive Advertising*, 10(2), 61-66. doi: 10.1080/15252019.2010.10722170
- Maxham, J.G. (2001). Service recovery's influence on consumer satisfaction, positive word-of-mouth, and purchase intentions. *Journal of Business Research*, 54, 11-24. doi: 10.1016/S0148-2963(00)00114-4
- Maxham, J.G., & Netemeyer, R.G. (2002). Modeling customer perceptions of complaint handling over time: the effects of perceived justice on satisfaction and intent. *Journal of Retailing*, 78(4), 239-252. doi: 10.1016/S0022-4359(02)00100-8
- Misirlis, N. & Vlachopoulou, M. (2018). Social media metrics and analytics in marketing – S3M: A mapping literature review. *International Journal of Information Management*, 38, 270-276. doi: 10.1016/j.ijinfomgt.2017.10.005
- Muntinga, D.G., Moorman, M., & Smit, E.G. (2011). Introducing COBRAs: exploring motivations for brand-related social media use. *International Journal of Advertising*, 30(1), 13-46. doi: 10.2501/IJA-30-1-013-046
- Nisar, T. M., & Whitehead, C. (2016). Brand interactions and social media: Enhancing user loyalty through social networking sites. *Computers in Human Behavior*, 62, 743-753. doi: 10.1016/j.chb.2016.04.042
- Oliver, R., & Swan, J.E. (1989). Consumer perceptions of interpersonal equity and satisfaction in transactions: a field survey approach. *Journal of Marketing*, 53, 21-35. doi: 10.1177/002224298905300202
- Ozbay, F. A. & Alatas, B. (2019). Fake news detection within online social media using supervised artificial intelligence algorithms. *Physica A: Statistical Mechanics and its Applications*, 540, article 123174. doi: 10.1016/j.physa.2019.123174
- Rauniar, R., Rawski, G., Johnson, B., & Yang, J. (2013). Social Media User Satisfaction—Theory Development and Research Findings. *Journal of Internet Commerce*, 12(2), 195-224. doi: 10.1080/15332861.2013.817864
- Rossiter, J.R., & Percy, L. (1987). *Advertising and Promotion Management*. New York: McGraw-Hill.
- Sano, K. (2015). *An empirical study the effect of social media marketing activities upon customer satisfaction, positive word-of-mouth and commitment in indemnity insurance service*. Paper presented at International Marketing Trends Conference 2015. Paris. Retrieved from <http://archives.marketing-trends-congress.com/2015/pages/PDF/141.pdf>
- Schiffman, G.L., Kanuk, L.L., & Kumar, R.S. (2010). *Consumer Behaviour*. New Jersey: Prentice Hall.
- Schmenner, R.W. (1986). How can service businesses survive and prosper? *Sloan Management review*, 27(3), 21-32. Retrieved from <https://europepmc.org/article/med/10300742>
- Seo, E. J., & Park, J. W. (2018). A study on the effects of social media marketing activities on brand equity and customer response in the airline industry. *Journal of Air Transport Management*, 66, 36-41. doi: 10.1016/j.jairtraman.2017.09.014
- Song, Q., Wang, Y., Chen, Y., Benitez, J., & Hu, J. (2019). Impact of the usage of social media in the workplace on team and employee performance. *Information & Management*, 56(8), article 103160. doi: 10.1016/j.im.2019.04.003

- Sozer, E. (2019). The Effect of Social Media Mix on Brand Switching Intention: The Mediating Role of Risk Perception. *Journal of Yasar University*, 14(53), 74-86.
- Spreng, R.A., Harrell, G.D., & Mackoy, R.D. (1995). Service recovery: impact on satisfaction and intentions. *Journal of Services Marketing*, 9(1), 15-23. doi: 10.1108/08876049510079853
- Subramanian, K.R. (2018). Social media and the word of mouth publicity. *International Research Journal of Advanced Engineering and Science*, 3(2), 95-100. Retrieved from [https://www.researchgate.net/publication/327366758\\_Social\\_media\\_and\\_the\\_word\\_of\\_mouth\\_publicity](https://www.researchgate.net/publication/327366758_Social_media_and_the_word_of_mouth_publicity)
- Trusov, M., Bucklin, R. E. & Pauwels, K. (2009). Effects of word-of-mouth versus traditional marketing: Findings from an internet social networking site. *Journal of Marketing*, 73, 90-102. doi: 10.1509/jmkg.73.5.90
- Wang, C., & Wu, L. (2011). Reference effects on revisit intention: Involvement as a moderator. *Journal of Travel & Tourism Marketing*, 28(8), 817-827. doi: 10.1080/10548408.2011.623041
- Wang, Y., & Fesenmaier, D.R. (2004), Modeling participation in an online travel community. *Journal of Travel Research*, 42, 261-270. doi: 10.1177/0047287503258824
- Wong, A., & Sohal, A. (2002). An examination of the relationship between trust, commitment, and relationship quality. *International Journal of Retail & Distribution Management*, 30(1), 34-50. doi: 10.1108/09590550210415248
- Yoshida, M., Gordon, B. S., Nakazawa, M., Shibuya, S., & Fujiwara, N. (2018). Bridging the gap between social media and behavioral brand loyalty. *Electronic Commerce Research and Applications*, 28, 208-218. doi: 10.1016/j.elerap.2018.02.005
- Zakaria, I., Rahman, B.A., Othman, A.K., & Azlina, N., Yunus, M., Dzulklipli, M.R., & Osman, M.A.F (2014). The Relationship between Loyalty Program, Customer Satisfaction and Customer Loyalty in Retail Industry: A Case Study. *Procedia - Social and Behavioral Sciences*, 129(15), 23-30. doi: 10.1016/j.sbspro.2014.03.643
- Zeithaml, V.A., Berry, L.L., & Parasuraman, A. (1996). The behavioral consequences of service quality. *Journal of Marketing*, 60(2), 31-46. doi: 10.1016/j.sbspro.2014.03.643

## Contact information

### Romina Cheraghalizadeh

Technical University of Liberec, Faculty of Economics  
 Voroněžská 13, 46001, Liberec, Czech Republic  
 E-mail: romina.cheraghalizadeh@tul.cz  
 ORCID: 0000-0002-3984-1048

doi: 10.7441/dokbat.2019.040



# BRAND MANAGEMENT ANALYSIS: AN EMPIRICAL STUDY IN HIGHER-QUALITY CZECH RAILWAY TRAINS

*Jan Chochooláč, Nina Kudláčková*

## Abstract

The Czech market in the field of public passenger rail transport was opened in 2011. Since then, several competitors have entered the market and have started gradually develop its brand at the expense of the national carrier Czech Railways. Customers were thus able to use the services of multiple carriers and began to compare their experience with the quality of these services, and the services provided by the national carrier did not work best, especially because customers were confusing their experience from different types of trains and sessions. The national carrier was thus forced to respond to this situation with the help of brand management, which helped it set comparable conditions with those of the competing ones, because the brand could thus be associated with the quality of services provided on specific and mutually comparable sessions. The authors of this article decided to carry out an empirical study in the field of brand management and to analyse the current situation in the development of brand management of higher-quality Czech Railways trains area in the period from 2009 to 2019. The method of qualitative comparative analysis was used for empirical analysis of data concerning individual Czech Railways connections. From above mentioned reasons only higher quality trains will be analysed, i.e. Fast Train, Express, InterCity, EuroCity, SuperCity, Railjet and EuroNight trains. The results of the analysis showed that the proportion of trains to which brand management tools have been applied is increasing overall, with the fastest growth being in the fast trains category.

**Keywords:** *brand management, brand development, Czech Railways, marketing communication, service quality, higher-quality trains, long distance train lines*

## 1 INTRODUCTION

Probably the first publication on brand orientation was publication by Mats Urde (1994) named Brand orientation – a strategy for survival in Journal of Consumer Marketing. Since than the problematics of Brand Management became a very important part of marketing. As Kotler (2007) mention, Brand Management, Brand Value, and consumer association associated with the brand can have a major impact on business economic results.

Evans, Bridson and Rentschler (2012) defined brand orientation in European Journal of Marketing “*as the extent to which the organization embraces the brand at a cultural level and uses it as a compass or decision-making to guide four brand behaviours; distinctiveness, functionality, augmentation and symbolism*”.

Kotler and Keller (2007) say that Brand Management can also be defined as long-term effective brand management and related marketing decisions. Clow and Baack (2008) realized that management, building and image of the brand are the main factors of business success.

There was in past, is now, and probably will be in the future, much discussion about the definition of brand, branding, brand management, brand development or however you want to call it. For some company brand means their product – especially when it is a special or unique product, for some company brand means the name of the company or the aim or mission of the company. Marketing point of view is that the brand means the logo and good will. But the

question how is it with branding in case of service. As we all know, service can never be still the same, so as the product is, because service, and quality of service changes very quickly in time, because it depends on many variables.

Taylor (2007) adds that Brand Management also exists to help customers simplify their lives by helping them navigate more quickly in their purchasing decisions. The Czech Railways Company has taken this idea and decided to apply it to its high-quality long-haul connections in order to clearly separate them from other, in many cases, lower-quality train connections.

Czech Railways (2009) made the document “Contractual and Transport Terms form Public passenger Transport (SPPO) and defined in this document all new train names, conditions and quality demand. Management obviously deals with maintaining and advancing the brand through single marketing efforts such as good will, public relations, advertising, design, strategy or social media presentation are, which is probably what also people thing the brand management is about. The railway company Czech Railways decided to go this way and started to apply Brand Management on the high-quality long-haul connections. This article analysis the method of implementation and success of Brand Management application in the railway competition area.

## **2 THEORETICAL BACKGROUND**

As mentioned in the introduction, Brand Management was in past important part of scientific research. For example, Urde (1994) defined brand orientation as “*an approach in which the processes of the organization revolve around the creation, development, and protection of brand identity in an ongoing interaction with target customers with the aim of achieving lasting competitive advantages in the form of brands*”. According to Becker and Albers (2015), not only scientists, but especially management of public transport companies, increasingly focused on quality management services, while regularly monitoring the quality of services, evaluate it and make appropriate management decisions that would was to reflect the results of the evaluation of the quality of services provided by customers, as evidenced by Hensher, Stopher and Bullock (2003).

Tsami and Nathanail (2017) emphasize that the issue of quality of public transport services has been studied in terms of marketing, management and social sciences. One of the best known and most used models for evaluating the quality of public transport services is, according to the authors, the GAP model designed by Parasuraman, Zeithaml and Berry (1985).

According to Parasuraman, Zeithaml and Berry (1985), the GAP model combines a customer and carrier marketer perspective, identifying gaps in five defined areas: the gap between customer expectations and customer perceptions by company management, the gap between customer perceptions by carrier’s quality of the service offered, the gap between the quality of the service offered and the quality of service currently provided, the gap between the quality of the service offered and communicating this quality to customers, the gap between the customer's expected quality of the service offered and the customer's perceived quality of service.

As Kotler (2007) says, marketing point of view is that service brands define the product by giving it an additional type including a brand name and an abbreviation. As the UIC (2019) says, service brands are used to associate a service brand with a service mode or a train generic service mode (Train, High speed train, Interregional, Regional, (Sub) urban, Night train, Motor rail, Mountain train, Historic train). Tim Sandler (2017) discusses the problem in the area of reputation of railway asking about the point in building a brand for a train company. He emphasizes the importance of a train operating company’s brand and how decisive this is in

regards to passenger satisfaction and experience. So, it is he who comes up with a marketing perspective on brand management. He also mentions that society often talk about the lack of choice in rail travel when after all, for most journeys, only one train company serves the route that an individual passenger needs, because some researches showed that customer satisfaction is clearly led by operational competence, so maybe it doesn't really matter who runs it.

Kotler and Keller (2007) define three basic types of brands:

- a) corporate brand
- b) umbrella brand and
- c) individual brand.

Kotler and Keller (2007) mention, that the brand name is considered the highest brand level, indicates the company name, and can be used for specific products. The umbrella brand always covers some part of the company's product portfolio and the individual brand is used for one product within one category.

This is what the Czech Railways company came out of and started to apply to its high-quality long-haul connections. As written in internal material of Czech Railways (2012), there are three basic types of signs used in railway passenger transport in the Czech Republic as follows:

- a) corporate brand – companies Leo Express s.r.o. (for example train LE 1350 Leo Express), RegioJet a.s. (for example train RJ 1034 RegioJet), Arriva Transport Česká republika a.s. (for example train AEx 1061 Arriva Express);
- b) umbrella brand – company České dráhy a.s. (used for long-distance trains);
- c) individual brand – for example company KŽC Doprava s.r.o. (for example train R 1570 Rakovnický rychlík, R 1577 Blatenský motoráček).

The company Czech railways started since the season 2018/2019 built and publish timetable to use the Brand Management (umbrella brand) for long-distance trains, where the connections of each long-distance line (according to the starting and destination destinations) bear the same designation (Table 1).

Tab. 1 – Brand management of the Czech Railways. Source: České dráhy (2018)

line	line name	route	line	line name	route
	SC (IC) Pendolino	(Fr. Lázně/Cheb –) Praha – Ostrava / Bohumín	R 12	Bouzov	Brno – Olomouc – Šumperk
	SC Pendolino Košičan	Praha – Košice	R 13	Moravan	Brno – Břeclav – Přerov – Olomouc
Ex 1	Ostravan	Praha – Bohumín / Návší / Žilina	R 14	Ještěd	Pardubice – Liberec
Ex 1	Opavan	Praha – Opava	R 15	Ploučnice	Liberec – Ústí nad Labem
Ex 1	Varsovia	Praha / Ostrava – Warszawa	R 16	Berounka	Praha – Plzeň – Klatovy / Železná Ruda
Ex 1	Fatra	Ostrava – Žilina – Banská Bystrica / Zvolen	R 17	Vltava	Praha – České Budějovice
Ex 2	Valašský expres	Praha – Vsetín / Žilina	R 17	Lužnice	Praha – Tábor – Veselí nad Lužnicí
Ex 3	Vindobona	Praha – Wien – Graz	R 18	Slovácký expres	Praha – Olomouc – Luhačovice / Veselí n. M.
Ex 3	Berliner	Praha – Berlin / Hamburg	R 19	Svitava	Praha – Česká Třebová – Brno
Ex 3	Metropolitan	Praha – Bratislava – Budapest	R 20	Labe	Praha – Děčín
Ex 6	Západní expres	Praha – Plzeň – München / Cheb	R 21	Jizera	Praha – Turnov / Tanvald / Harrachov

Ex 7	Jižní expres	Praha – České Budějovice / Linz	R 22	Bezděz	Kolín – Rumburk / Šluknov
R 5	Krušnohor	Praha – Ústí nad Labem – Karlovy Vary – Cheb	R 23	Střekov	Ústí nad Labem – Kolín
R 8	Slezan	Brno – Bohumín	R 24	Lány	Praha – Rakovník
R 9	Vysočina	Praha – Havlíčkův Brod (Jihlava) – Brno	R 26	Otava	Praha – Písek – České Budějovice
R 10	Hradečan	Praha – Hradec Králové – Trutnov	R 27	Praděd	Olomouc – Krnov – Ostrava
R 11	Rožmberk	Brno – České Budějovice / Plzeň	R 27	Cvilín	Krnov – Ostrava
R 11	Bezdrev	České Budějovice – Plzeň			

### 3 METHODOLOGY

Before all, the quantitative content analysis was used for the analysis. Matthes et al. (2017) described quantitative content analysis as a research method in which textual, visual, or aural material is systematically categorized and recorded so that they can be analysed. Dvořáková (2010) considers quantitative content analysis to be a simple, adaptable, yet systematic and objectively close method that can be applied to virtually any data set and can be used especially where it is not possible or effective to apply more investigative methods of investigation.

As part of the analysis, regular higher-quality Czech Railways trains (Fast Train, Express, InterCity, EuroCity, SuperCity, Railjet and EuroNight) were examined during the 2009/2010 to 2018/2019 timetable. Train data of České dráhy, a.s. was obtained from ŽelPage (© 2001-2019). The total number of trains in a given quality category and the number of branded trains in a given quality category between 2009/2010 and 2018/2019 were always examined. Variable  $t_{ij}$  denotes the total number of trains in a given timetable validity and in a given category, with variable  $i$  indicating the period of validity of the timetable (2009/2010; 2010/2011; 2011/2012; 2012/2013; 2013/2014; 2014/2015; 2015/2016; 2016/2017; 2017/2018; 2018/2019) and the variable  $j$  indicates the category (Table 2).

Tab. 2 – Categories of trains. Source: ŽelPage (© 2001-2019)

variable	Czech	train category
1	R + Rx	Fast train + Higher quality fast train
2	Ex	Express
3	IC	InterCity
4	EC	EuroCity
5	SC	SuperCity
6	rj	railjet
7	EN	EuroNight

The number of trains of all categories in one year of the timetable can be mathematically expressed using relation 1.

$$\sum t_i^j[-]; i = konst.; j \in \langle 1; 7 \rangle \quad (1)$$

The number of trains of the selected category in all analysed years of timetable validity can be mathematically expressed using relation 2.

$$\sum t_i^j[-]; i \in \langle 2009/2010; 2018/2019 \rangle; j = konst. \quad (2)$$

The number of trains of all categories in all analysed timetable years can be mathematically expressed using relation 3.

$$\sum \sum t_i^j [-]; i \in \langle 2009/2010; 2018/2019 \rangle; j \in \langle 1; 7 \rangle \quad (3)$$

The variable  $s_i^j$  indicates the percentage of tagged trains in the total number of trains in a given category and given the timetable validity, and variable  $b_i^j$  indicates the number of trains tagged, with  $i$  indicating the period of validity of the timetable (2009/2010; 2010/2011; 2011/2012; 2012/2013; 2013/2014; 2014/2015; 2015/2016; 2016/2017; 2017/2018; 2018/2019) and variable  $j$  denotes the category (Table 2).

The percentage of branded trains in the total number of trains in the selected category and with the selected timetable validity can be calculated according to relation No. 4.

$$s_i^j = \frac{b_i^j}{t_i^j} * 100 [\%]; i = konst.; j = konst. \quad (4)$$

The percentage of branded trains in the total number of trains in all categories and with the chosen timetable validity can be calculated according to relation 5.

$$s_i^j = \frac{\sum b_i^j}{\sum t_i^j} * 100 [\%]; i = konst.; j \in \langle 1; 7 \rangle \quad (5)$$

The percentage of branded trains in the total number of trains in all categories and in all analysed timetable years can be calculated according to relation 6.

$$s_i^j = \frac{\sum \sum b_i^j}{\sum \sum t_i^j} * 100 [\%]; i \in \langle 2009/2010; 2018/2019 \rangle; j \in \langle 1; 7 \rangle \quad (6)$$

## 4 RESULTS

As mentioned above, the company Czech Railways decided to apply Brand Management in the conditions of their high-quality long-haul connections. The question is whether it was a step in the right direction. Results of this empiric analysis shows the results of applying this method since 2009. Table 3 shows the total number of regular connections of Czech Railways in the analysed years 2009/2010 to 2018/2019 for the R + Rx, Ex, IC and EC train categories.

Tab. 3 – Total number of trains in categories R + Rx, Ex, IC and EC. Source: ŽelPage (© 2001-2019)

year	R + Rx		Ex		IC		EC	
	total	branded	total	branded	total	branded	total	branded
2009/2010	457	112	13	12	36	36	53	53
2010/2011	468	120	33	33	35	35	40	40
2011/2012	449	115	58	57	21	21	40	40
2012/2013	439	154	58	58	0	0	42	42
2013/2014	433	190	12	12	14	14	62	62
2014/2015	440	191	24	24	11	11	50	50
2015/2016	420	198	32	32	12	12	58	58
2016/2017	416	205	64	58	8	4	48	48
2017/2018	424	198	74	74	12	8	46	46
2018/2019	419	412	73	73	12	12	46	46

Notes: R + Rx – Fast train + Higher quality fast train, Ex – Express, IC – InterCity, EC – EuroCity, SC – SuperCity, rj – railjet, EN – EuroNight

Tab. 4 shows the total number of regular connections of České dráhy, a.s. in the analysed years 2009/2010 to 2018/2019 for the SC, rj and EN train categories.

Tab. 4 – Total number of trains in SC, rj and EN categories. Source: ŽelPage (© 2001-2019)

year	SC		rj		EN		all categories	
	total	branded	total	branded	total	branded	total	branded
2009/2010	0	0	0	0	7	7	566	220
2010/2011	0	0	0	0	8	8	584	236
2011/2012	0	0	0	0	7	7	575	240
2012/2013	20	20	0	0	4	4	563	278
2013/2014	19	19	0	0	4	4	544	301
2014/2015	18	18	16	16	9	9	568	319
2015/2016	16	16	16	16	14	14	568	346
2016/2017	14	14	16	16	11	11	577	356
2017/2018	14	14	19	19	10	10	599	369
2018/2019	17	17	21	21	10	8	598	589

Notes: R + Rx – Fast train + Higher quality fast train, Ex – Express, IC – InterCity, EC – EuroCity, SC – SuperCity, rj – railjet, EN – EuroNight

Tab. 3 and Tab. 4 shows that Czech Railways dispatch the most trains in the fast train category (higher quality fast train), on the contrary, the least trains operate in the EN category. The tables also show that some categories of trains, or product lines, have been used by Czech Railways in the last seven years. These include, for example, the SC product line (from the 2012/2013 timetable) and rj (from the 2014/2015 timetable).

Fig. 1 represents the development of the share of branded trains in the total number of Czech Railways trains in the analysed years and categories. Fig. 1 shows that the share of branded trains of Czech Railways for the monitored categories of trains, it is increasing, except for 2017/2018, when a decrease of 0.10 percentage points was recorded. The most significant increase in the share of Czech Railways' branded trains was recorded between 2017/2018 and 2018/2019, which increased by 36.89 percentage points, reflecting the company's new brand management strategy (see Table 1).

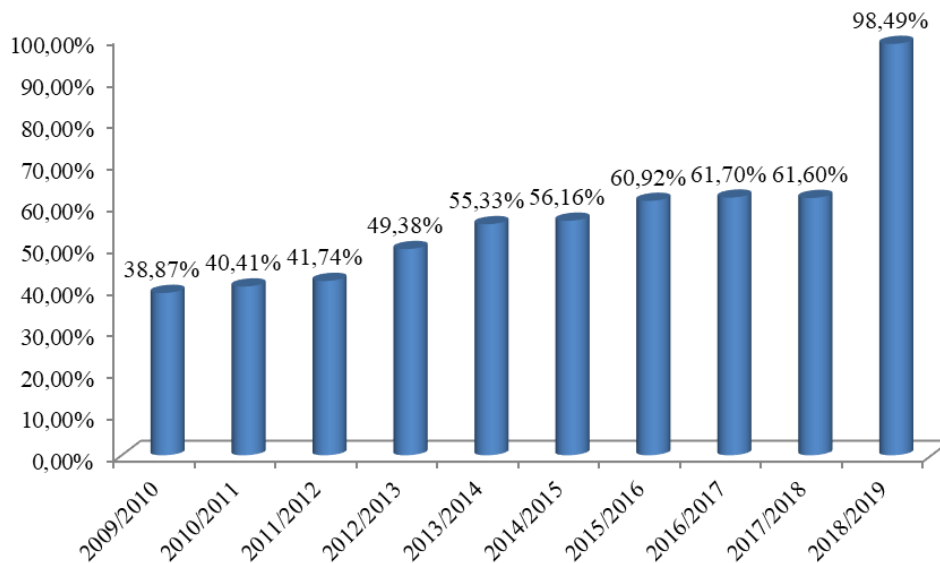

Fig. 1 – Development of the proportion of total number of branded trains. Source: own research

Fig. 2 shows the development of the share of branded trains of category R + Rx in the analysed years, as the share of branded trains in the category R + Rx increased most significantly. This increase was recorded between 2017/2018 and 2018/2019, when the share of branded trains increased from 46.70% to 98.33%, an increase of 51.63 percentage points.

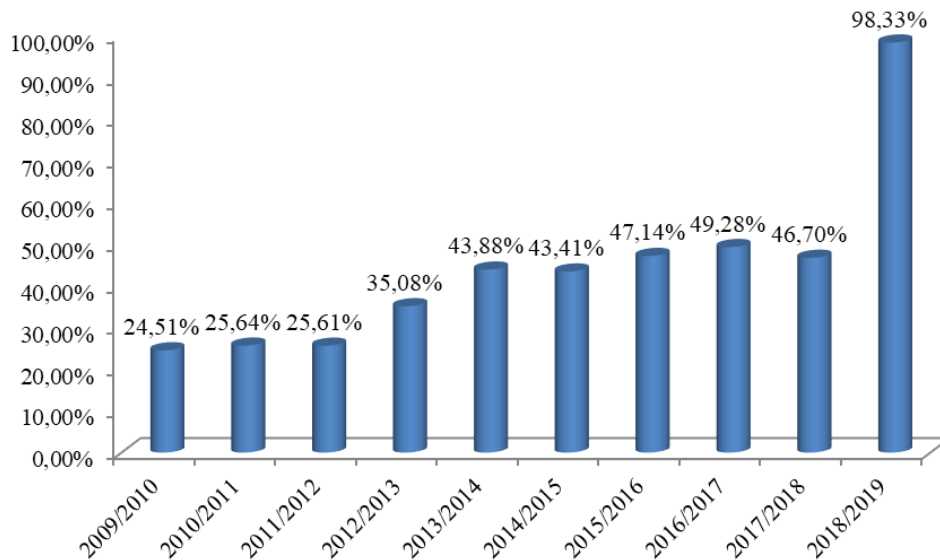

Fig. 2 – Development of the share of branded trains of category R + Rx. Source: own research

Fig. 3 presents the development of the proportion of branded trains by category in the analysed years. FIG. 3 shows that the largest share of branded trains consists of R + Rx trains, followed by Ex and EC trains. This is due to the number of trains that Czech Railways in that category.

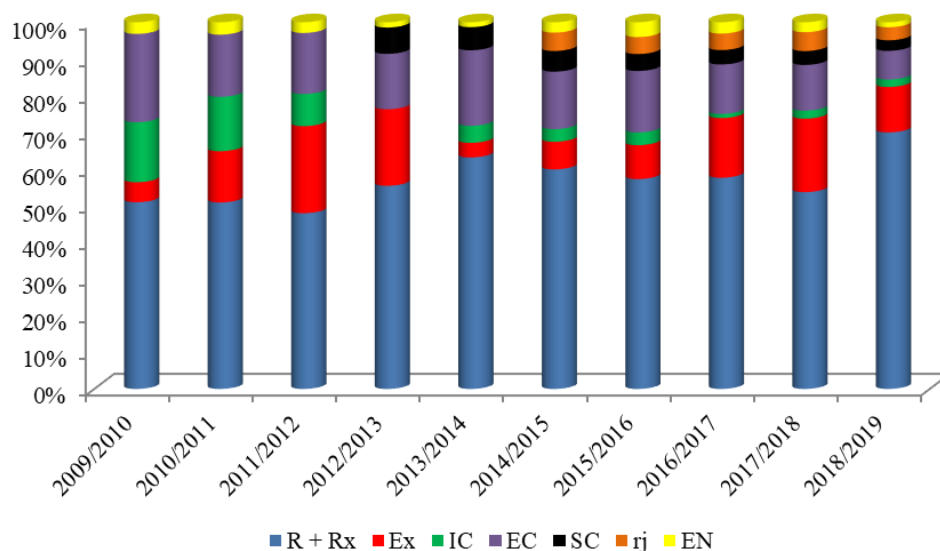

Fig. 3 – Development of the share of branded trains. Source: own research

## 5 CONCLUSION

Conclusions of the article are following. EuroCity trains have always been branded in all years (from 2009/2010 to 2018/2019). SuperCity trains have always been branded (all trains in this category) since 2012/2013, when this category was introduced. Railjet trains have always been branded (all trains in this category) since 2014/2015, when this category was introduced. EuroNight trains have always been branded in all years from 2009/2010 to 2017/2018 in the given category with the exception in year 2018/2019, when EuroNight trains EN 404 and EN 405 trains haven't been branded. InterCity trains have been branded from 2009/2010 to 2015/2016, with the exception in the year 2012/2013, because there was no train in this category. In 2016/2017 and 2017/2018 the decrease of branded trains up to 50% (in these years the trains IC 502; IC 509; IC 510; IC 511) were not branded. From 2018/2019 again return to

100%. Express trains hold between 90.63% and 100.00% of the branded trains in the category. Fast trains and Higher quality fast trains registered the most significant increase from 24.51% to 98.33% of the branded trains in this category. The quite significant increase in the proportion of trains from 38.87% to 98.49% was caused by the Fast trains and Higher quality fast trains branding. The most significant increase was recorded between 2017/2018 and 2018/2019, since Czech Railways introduced a unified branding of Czech Railways long-distance trains.

## Acknowledgment

This paper is published within the solution of the scientific research project of the University of Pardubice no. SGS\_2019\_010. The authors are grateful for their support.

## References

- Ceske Drahy (2018). *Uniform naming of lines will replace the names of individual trains on other lines*. Retrieved from <http://www.ceskedrahy.cz/tiskove-centrum/tiskove-zpravy/-30282/>
- Clow, K. E., & Baack, D. (2008). *Advertising, promotion and marketing communication*. Brno: Computer Press.
- Evans, J., Bridson, K., & Rentschler, R. (2012) Drivers, impediments and manifestations of brand orientation: An international museum study. *European Journal of Marketing*, 46(11-12), 1457-1475. doi: 10.1108/03090561211259934
- Garvale, J. (2015). *Brand Development vs. Brand Management*. Retrieved from <http://jgarvale.com/brand-development-vs-brand-management/>
- Kotler, P., & Keller, P. (2007). *Marketing management*. Praha: Grada.
- Parasuraman, A., Zeithaml, V. A., & Berry, L. L. (1985). A Conceptual Model of Service Quality and Its Implications for Future Research. *The Journal of Marketing*, 49(4), 41-50. doi: 10.2307/1251430
- Paulley, N., Balcombe, R., Mackett, R., Titheridge, H., Preston, J., Wardman, M., Shires, J., & White, P. (2006). The demand for public transport: The effects of fares, quality of service, income and car ownership. *Transport Policy*, 13(4), 295-306. doi: 10.1016/j.tranpol.2005.12.004
- Sánchez Pérez, M., Gázquez Abad, J. C., Marín Carrillo, G. M., & Sánchez Fernández, R. (2007). Effects of service quality dimensions on behavioural purchase intentions: a study in public-sector transport. *Managing Service Quality*, 17(2), 134-151. doi: 10.1108/09604520710735164
- Shifan, Y., & Sharaby, N. (2012). The Impact of Fare Integration on Travel Behavior and Transit Ridership. *Transport Policy*, 21, 63-70. doi: 10.1016/j.tranpol.2012.01.015
- Silaghi, S. (2010). Quality of Public Transportation Services in Urban Area of Oradea. *The Journal of the Faculty of Economics - Economic*, 1(2), 469-474. Retrieved from <https://ideas.repec.org/a/ora/journal/v1y2010i2p469-474.html>
- Tsami, M., & Nathanail, E. (2014). *Examining travelers' "Optimal strategies" in transit trip choice, applying a classification tree approach on transit quality of Service Indicators*. Paper presented at the International Conference on Engineering and Applied Sciences Optimization, Kos, Greece. University of Thessaly. doi: 10.1007/978-3-319-18320-6



Tsami, M., & Nathanail, E. (2017). Guidance Provision for Increasing Quality of Service of Public Transport. *Procedia Engineering*, 178, 551-557. doi: 10.1016/j.proeng.2017.01.108

UIC. (2019). *Documents*. Paris: UIC. Retrieved from <https://uic.org/#documents>

Urde, M. (1994). Brand orientation - a strategy for survival. *Journal of Consumer Marketing*, 3, 18-32. doi: 10.1108/07363769410065445

Vuchic, V. (2005). *Urban Transit: Operations, Planning, and Economics*. New Jersey: Wiley.

ŽelPage. (2019). *Train composition*. Retrieved from <https://www.zelpage.cz/razeni/>

### Contact information

#### **Ing. Jan Chocholáč, Ph.D.**

University of Pardubice, Faculty of Transport Engineering  
Studentská 95, 53210, Pardubice, Czech Republic

E-mail: [jan.chocholac@upce.cz](mailto:jan.chocholac@upce.cz)

ORCID: 0000-0002-7416-5014

#### **Ing. Nina Kudláčková, Ph.D.**

University of Pardubice, Faculty of Transport Engineering  
Studentská 95, 53210, Pardubice, Czech Republic

E-mail: [nina.kudlackova@upce.cz](mailto:nina.kudlackova@upce.cz)

ORCID: 0000-0002-1462-8283

doi: 10.7441/dokbat.2019.041

# RISK ANALYSIS IN THE LOGISTICS COMPANY FOR DISTRIBUTION OF PHARMACEUTICALS

*Lucie Chromcová*

## **Abstract**

The paper is focused on risk analysis in the logistics company, which distributed pharmaceuticals. Firstly, basic concepts in the field of logistics are discussed, and the approach to the correct distribution of medicines is emphasized. Secondly, a specific logistics company distributing medicines is also presented, including its transportation process. Additionally, failure mode and effect analysis (FMEA) as a risk analysis method is applied to the process. Based on the results of the analysis, recommendations are made to reduce the most severe risks in distribution pharmaceuticals.

*Keywords: risk, risk analysis, logistics company, distribution, pharmaceuticals*

## **1 INTRODUCTION**

In today's exciting times, humanity had to adapt to the rapid pressure on distribution time and logistics in general. The actual distribution of medicines is subject to demanding availability of all pharmaceuticals that people use. The cornerstone for medication distribution is the right fleet and the proper selection of a carrier to transport pharmaceuticals to pharmacies. For medicines to help the end customer, a specific transport system that does not violate storage and transport conditions need to be applied. With the increasing number of types of pharmaceuticals, the probability that something goes incorrect and the medicines will not reach the customer in the end, and further when applied in case of non-compliance with the transport conditions, has increased. They will not have the desired effect. We will try to identify, analyse, and set up possible measures to eliminate or mitigate the consequences of any situation that may hurt the medicine delivery logistics chain or on the safety of the drugs themselves.

Modern times have brought centralization and outsourcing to pharmacy logistics. In practice, this means that services or processes are set aside outside the organization. Own warehouses are not carried, but stocks in contract warehouses are used. Therefore, it is more efficient to control the assortment and better ability to manage all services at the central level, thus changing the quality for customers. Unfortunately, this also has its drawbacks; there may be insufficient flexibility. The outsourced company is more controllable. Besides, they hold their know-how and resources for their customers, which do not have to be dealt with by the outsourcing client. (Novák, 2005; Novák, 2011; Rushton, Croucher & Baker, 2014)

Due to changes in legislative rules, the stricter conditions for medication handling are a new trend. Direct distribution in the Czech Republic - direct to the pharmacy (DTP) or direct to the hospital (DTH) - is the common widely used in the Czech Republic. How does such direct drug distribution work? Distributors do not care about anything, because manufacturers themselves watch for parallel trade and get their distribution authorization. In practice, this means that the traditional distribution network is not used, but drugs are supplied directly to pharmacies, and the manufacturer takes over the activities of the distributor. (Kluska, 2016; Weberová, 2013)

The aim of this paper is to map and analyse processes in the logistics chain of medication transport and to create proposals for reducing or eliminating risks in a logistics company for drug distribution. To propose options for improving the distribution process itself. It is essential

to imagine concepts from the fields of logistics, distribution in general, medication distribution, fleet determination for pharmaceuticals alone, and approaches.

## **2 METHODOLOGY**

The FMEA method was chosen for the analysis of the pharmaceutical distribution process for the Olomouc Transshipment Station. The emerging processes were used to analyse risks and, based on frequencies, to propose risks or minimize them. For the various severe risks unacceptable by the dock owner, such proposals will be accompanied by a degree of risk reduction, which could be applied in the future to create a better functioning risk reduction system. Failure Mode and Effects Analysis (FMEA) was used in this paper. It is an analytical method that ensures prevention and possible solution to potential problems in the system of origin of the whole process. Risk analysis is part of the study. The application of the FMEA method is performed as an examination of functions or changes, assuming the risk of possible failure.

By introducing the results of the analysis into the evaluated process, increased attention will be paid to each subsystem, element separately. Each item valued as critical is then assessed according to our priorities, e.g. impact on the whole system of processes. FMEA is applied as a prevention against the problem itself, so its timely application to the process is essential. Thanks to this analysis, we could prevent a possible critical situation before it occurs, at a lower cost than after its occurrence. Properly applied measures are introduced as a reduction of the probability of deviation in the whole process. (Petrašová, 2008; Procházková, 2011)

When creating an FMEA design or the FMEA process itself, we will use a standard problem-solving approach. Comprehensive analysis system consists of: concept of basics for analysis, subject of analysis, end customers (for whom the analysis is intended), identification of functions and continuity of elements, consequences of failures and defining emerging failures, enumeration of failure management tools (causes of crashes) or measures and suggestions for risk elimination. (Petrašová, 2008; Procházková, 2011)

## **3 CURRENT STATE**

Due to the increased number of pharmaceuticals, a large number of errors and disturbances have been seen that affect the operation of the Transshipment Station. Although the Transshipment Centre was established about ten years ago, there was never any analysis applied, so we decided to set up a risk analysis for failures and serviceability. It would be desirable for the analysis to comply with the transport and general conditions for the distribution of drugs and to comply with all applicable standards. Therefore, the work aims to create the correct FMEA analysis, propose risk measures and recommendations in control, deadline, and possible mitigation of risk impact. Then interpret the results to the owner of the Transshipment.

PHOENIX Company has been a leader in the distribution market in the Czech Republic for several years. It has been a member of the multinational PHOENIX Group, one of Europe's top drug distribution companies since 1994. The Group operates in 26 European countries, with more than a thousand business partners (pharmacies, hospitals, and pharmaceutical manufacturing companies) happy with its services and time flexibility. Over the long years of its operations in the Czech Republic, Phoenix has built a base of six shopping centres that create a reliable network for the storage and subsequent distribution of pharmaceuticals in Bohemia and Moravia. (PHOENIX, 2017)

## 4 RESULTS

The FMEA method was chosen for the risk analysis in the pharmaceutical distribution company. Based on process and error observations, the following criteria were analysed and evaluated.

Tab. 1 – FMEA. Source: own research

The meaning of the consequences of error	Level of meaning	Classification
<b>Extremely serious</b>	the significance of the error is extremely high; the failure endangers the safety and conditions for medicine transport	<b>9 – 10</b>
<b>Significant</b>	dissatisfaction is tremendous and is caused by a wrong action in the logistics chain, the high probability that the error will occur	<b>7 – 8</b>
<b>Moderate</b>	the significance of the error will create discontent at the customer	<b>4 – 6</b>
<b>Insignificant</b>	the significance of the error may be of concern to the customer	<b>2 – 3</b>
<b>Hardly noticeable</b>	it is unlikely that the error will affect the customer (the customer will not notice the error)	<b>1</b>

The effect of the consequences of errors occurring in individual processes was analysed according to the importance of the failure per customer or the entire logistics chain. It was agreed with the owner of the Transshipment Centre that the significance limits would also be included in the medium-term consequences of errors depending on the remaining criteria.

Tab. 2 – FMEA. Source: own research

The meaning of the consequences of error	Level of meaning	Classification	Failure rate
<b>Extremely serious</b>	failure cannot be detected and secured	<b>10</b>	450 from 1000
		<b>9</b>	
<b>High</b>	check performed, failure occur frequently	<b>8</b>	350 from 1000
		<b>7</b>	
		<b>6</b>	
<b>Small</b>	check performed, failure arise on a smaller scale	<b>5</b>	290 from 1000
		<b>4</b>	
<b>Slight</b>	only minor failures are considered	<b>3</b>	200 from 1000
		<b>2</b>	
<b>Unlikely</b>	we can almost eliminate failure	<b>1</b>	150 from 1000

The occurrence of the consequences of errors was analysed for less than two years. These errors were recorded in frequency. Based on this data, a network of controls for early detection was established.

Tab. 3 – FMEA. Source: own research

Probability of failure detection	Probability level	Classification
<b>High</b>	process security methods cannot be provided	<b>10</b>
<b>Moderate</b>	Process security methods could barely detect a potential failure	<b>8 – 9</b>
<b>Small</b>	Process security methods have a probability of detection	<b>5 – 7</b>
<b>Very small</b>	Process security methods could detect a possible failure	<b>2 – 4</b>
<b>Unlikely</b>	methods of securing the detection process most likely a possible failure (the process detects the failure automatically)	<b>1</b>

The probability of error detection ensures early detection of the error and its securing in the bud of the whole process.

Tab. 4 – Risk calculation. Source: own research

Risk calculation		
Small risk	<1;200>	Green
Medium risk	<201;395>	Yellow
High risk	<396;900>	Red

## 5 PROPOSED MEASURES AND RECOMMENDATIONS

Measures and recommendations should reduce the impact of risks or eliminate failures. When carrying out the FMEA, each process was individually designed to reduce the probability of a mistake. The proposed measures and recommendations will always be specified for the process steps in the following table. The most critical failures will be selected.

Tab. 5 – FMEA. Source: own research

<b>Action (process step) 1</b>		
Reception of crates, cartons		
<b>Proposed measures</b>		
The possibility of external employees in the expedition their trained.		
<b>Risk level</b>		
	before treatment:	504
	after treatment:	200
	risk reduction by:	39%
<b>Action (process step) 2</b>		
Reception of crates, cartons		
Missing crate		
<b>Proposed measures</b>		
Marking of mixed pallets and additional training, every six months.		
<b>Risk level</b>		
	before treatment:	280
	after treatment:	84
	risk reduction by:	30%
<b>Action (process step) 3</b>		
Sorting into individual routes		
Cardboard damage		
<b>Proposed measures</b>		
Repacking into thicker cartons, glued bottom of cartons.		
<b>Risk level</b>		
	before treatment:	560
	after treatment:	90
	risk reduction by:	16%
<b>Action (process step) 4</b>		
Sorting into individual routes		
Excess crates, cartons		
<b>Proposed measures</b>		
Check by shipping manager before palletizing. Additional write-offs based on route and barcode.		
<b>Risk level</b>		
	before treatment:	294
	after treatment:	63
	risk reduction by:	22%
<b>Action (process step) 5</b>		
Loading at the Olomouc reloading station		
Deterioration of the medicines		
<b>Proposed measures</b>		
When packing into crates and cardboard boxes, we wrap the medicines with a solid bubble foil.		
<b>Risk level</b>		
	before treatment:	210
	after treatment:	63
	risk reduction by:	30%
<b>Action (process step) 6</b>		
Loading at the Olomouc reloading station		
mpairment of primary packaging		
<b>Proposed measures</b>		
When packing into crates and cardboard boxes, we wrap the medicines with a solid bubble foil.		
<b>Risk level</b>		
	before treatment:	405
	after treatment:	54
	risk reduction by:	13%
<b>Action (process step) 7</b>		
Loading at the Olomouc reloading station		
Degradation of secondary packaging		
<b>Proposed measures</b>		
Tighter lids of crates, so that when stacking crates can withstand the weight. In circulation older types still several years.		
<b>Risk level</b>		
	before treatment:	245

	after treatment:	72
	risk reduction by:	30%
<b>Action (process step) 8</b>		
Loading at the Olomouc reloading station		
Loading multiple boxes, cartons		
<b>Proposed measures</b>		
In case of missing box / carton on another route check all loaded vehicles at the Transshipment Station before leaving for unloading to the pharmacy.		
<b>Risk level</b>		
	before treatment:	210
	after treatment:	84
	risk reduction by:	40%
<b>Action (process step) 9</b>		
Unloading at the pharmacy		
Broken boxes, cardboard boxes		
<b>Proposed measures</b>		
Tightening lids of crates, so that when stacking crates can withstand the weight. In circulation older types still several years.		
<b>Risk level</b>		
	before treatment:	280
	after treatment:	120
	risk reduction by:	43%
<b>Action (process step) 10</b>		
Unloading at the pharmacy		
Lack of cash at the pharmacy		
<b>Proposed measures</b>		
Rewards for payment via invoice. Faster handling of take-backs, or acute pick-ups and transfers individually.		
<b>Risk level</b>		
	before treatment:	336
	after treatment:	168
	risk reduction by:	50%
<b>Action (process step) 11</b>		
Unloading at the pharmacy		
Theft of financial cash		
<b>Proposed measures</b>		
Surrender within 24 hours otherwise sanctions on payments in the form of deductions.		
<b>Risk level</b>		
	before treatment:	800
	after treatment:	90
	risk reduction by:	12%
<b>Action (process step) 12</b>		
Checking the number		
Damaged primary packaging		
<b>Proposed measures</b>		
Inserting the bubble foil to the drug (wrapping) and cardboard board to the bottom of the box.		
<b>Risk level</b>		
	before treatment:	360
	after treatment:	96
	risk reduction by:	27%
<b>Action (process step) 13</b>		
Back "return"		
Damaged primary packaging		
<b>Proposed measures</b>		
Warning to the driver whether it is a refrigerator or uncooled goods, larger labels, the obligation to put the driver in the crate		
<b>Risk level</b>		
	before treatment:	720
	after treatment:	96
	risk reduction by:	14%
<b>Action (process step) 14</b>		
Back "return"		
Insufficient secondary packaging		
<b>Proposed measures</b>		
Larger labels on the return mark with the possibility to beeped at the dock using a gun. The obligation of the driver to put the "return" in the crate when transporting to the Transshipment and placing it in bubble wrap.		
<b>Risk level</b>		
	before treatment:	252
	after treatment:	84
	risk reduction by:	34%

## 6 CONCLUSION

The paper dealt with the issue of risk analysis at the Transshipment for Pharmaceuticals. The aim was to create comprehensive proposals for reducing or eliminating risks in the logistics chain process at a pharmaceutical distribution company. The reader was acquainted with basic concepts and the procedure for resolving emerging failures. It was essential to introduce the pharma wholesale company Phoenix, a.s. and its transport procedure with haulers at the Olomouc transshipment station. FMEA analysis was used in the theoretical part. By mapping the risks and processes of the Medical Stations, the individual risk measures for the steps have made suggestions to eliminate or reduce critical risks or risks that might begin to emerge to a greater extent in the future. Based on the results of the FMEA analysis, the objective of the work has been fulfilled, and the implementation of proposals in practice can lead to an overall reduction of the total process failure by up to half.

### References

- Kluska, V. (2016). *Změni legislativní úprava reexportů lékových trh?* Retrieved from <https://zdravi.euro.cz/clanek/zmeni-legislativni-uprava-reexportu-lekovy-trh-481593>
- Novák, R. (2011). *Přepravní, zasílatelské a logistické služby*. Praha: Wolters Kluwer.
- Novák, R. (2005). *Nákladní doprava a zasílatelství*. Praha: ASPI.
- Petrašová, I. (2008). *Analýza možných způsobů a důsledků poruch (FMEA): Referenční příručka*. Praha: Česká společnost pro jakost.
- PHOENIX. (2017). *Profil společnosti*. Retrieved from <http://www.phoenix.cz/o-nas/profil-spolecnosti/>
- Procházková, D. (2011). *Analýza a řízení rizik*. Praha: ČVUT.
- Rushton, A., Croucher, P. & Baker, P. (2014). *The Handbook of Logistics and Distribution Management*. London: Kogan.
- Weberová, A. (2013). *Logistika léků: Ortodoxní pravidla*. Retrieved from <https://www.systemylogistiky.cz/2013/05/06/logistika-leku-ortodoxni-pravidla/>

### Contact information

#### Lucie Chromcová

Tomas Bata University in Zlín, Faculty of Logistics and Crisis Management  
Studentské nám. 1532, 68601, Uherské Hradiště, Czech Republic  
E-mail: [l\\_chromcova@utb.cz](mailto:l_chromcova@utb.cz)  
ORCID: 0000-0001-7218-7394

doi: 10.7441/dokbat.2019.042

# CUSTOMER LOYALTY IN SMALL AND MEDIUM-SIZED CZECH ENTERPRISES

*Adéla Chromčáková*

## **Abstract**

The aim of the article is to present the research results focus on customer loyalty as a part of customer relationship management in small and medium-sized enterprises. The object of the research were small and medium-sized enterprises in the Moravian-Silesian Region in Czech Republic. The sample consisted of 1,446 respondents. The subject of the research was activities within the CRM architecture, both in the strategic part, as well as operational and collaborative CRM. The starting point of this article is a theoretical review on the issue researched. For the evaluation of selected activities, the modified PDCA method was used. Formulated hypotheses have been identified and evaluated by a Pearson correlation coefficient. Hypotheses were focused on the related enterprise size and selected activities. Correlation analysis has been applied to hypothesis verification. The high value of the correlation coefficient and the correlation significance test confirmed the statistically significant dependence on all variables. In our research sample, we found that there is a correlation between the size of SMEs and the implementation of the research activities. This was confirmed by the relative frequency of respondents' answers and verification of hypotheses. It is interesting finding that micro, small and also medium-sized enterprises do not implement two activities - setting up a method of determining who a loyal customer is and customer churn. Only the setting of the strategy for individual loyal customer implement most enterprises.

**Keywords:** *Customer Relationship Management, CRM, Customer, Loyal customer, SMEs*

## **1 INTRODUCTION**

Customer loyalty is developed over a period of time from a consistent record of meeting, and sometimes even exceeding customer expectations (Teich, 1997). Customer loyalty is viewed as the strength of the relationship between an individual's relative attitude and repeat patronage (Dick and Basu, 1994). According to Bloemer and Kasper (1995), loyalty is interpreted as true loyalty rather than repeat purchasing behaviour, which is the actual re-buying of a brand, regardless of commitment. Higher customer satisfaction and repeated purchases lead to customer relationship lengthening, business continuity, and loyalty. Kotler et al. (2007) mention a customer-oriented company and they perceive it as a company endeavouring to provide higher value to its customers. It is possible thanks to the fact that when such company implements new marketing strategies, it still watches the customer development very carefully. Success of a service provider depends on the high-quality relationship with customers (Panda, 2003) which determines customer satisfaction and loyalty.

The aim of the article is to present the research results focus on customer loyalty as a part of customer relationship management in small and medium-sized enterprises. In our research, we have dealt with all aspects of the CRM architecture. In this article, attention is narrowed to the customer loyalty part. Four hypotheses have been formulated and evaluated by a Pearson correlation coefficient.



## 2 CUSTOMER RELATIONSHIP MANAGEMENT AND CUSTOMER LOYALTY

The customer relationship management (or CRM) create an advantage and improve company performance on the business market. It is still developing area in scientific publication and in companies. The CRM is a strategic approach that integrates people, business, and technology to understand the customer needs (Mohammadhossein & Zakaria, 2012; Pozza et al., 2018). An important company objective is to serve its customers to their satisfaction. When customer gets a personalized attention in company, the customer would be satisfied. However, customer dissatisfaction with company is a potential threat to its market share and would damage the company reputation (Rai, 2013). But what the CRM means? Table 1. shows different perspectives of CRM definition.

Tab. 1 – CRM definition from different perspectives. Source: Chromčáková & Starzyczná (2018)

CRM Definition	Author
A method using software and technologies for automatic control and process improvement	Greenberg, 2001
CRM includes employees, company processes, IS/ICT technologies with the main objective to maximize customer loyalty and thereby company profitability	Dohnal, 2002
A universal process how to keep useful customers	Payne & Frow, 2004
CRM is understood as a special software program and analytical technique serving for integration and use of large databases about individual customers	Kotler & Armstrong, 2004
CRM is an interactive process that aims to achieve the optimal balance between a company investment and customer satisfaction, where the optimal balance is determined by the profit gained of both parties	Chlebovský, 2005
CRM is a strategic process that aims to develop good relationships with customers and customer groups and thus CRM creates bigger value for shareholders	Payne, 2007
The purpose of CRM is to get known strategic customers and to create long-term relationships with them, instead of endeavour to maximize short-term incomes	Lehtinen, 2007
CRM is a main business strategy which integrates internal processes and functions as well as external networks. It creates and brings added-value for profitable customers and is based on high-quality information about customers. CRM mediated by information technologies	Buttle & Maklan, 2015

Good and quality CRM affects aspects of value connected with customers. Rai (2013) states that CRM involves primarily building long-term customer relationships, understanding their needs and responding to them through more products and services across multiple channels of communication. An important task of CRM is to create value and communicate with customers. The goal is to obtain and maintain loyalty and customer satisfaction (Chromčáková et al., 2018).

### 2.1 Customer loyalty

Loyalty has been defined as “a deeply held commitment to rebuy or repatronize a preferred product or service consistently in the future” (Oliver, 1999). Customer loyalty has two meanings, a long-term and the short-term loyalty (Jones & Sasser, 1995). Customers with the long-term loyalty do not easily switch to other service providers, while customers with short-term loyalty defect more easily when offered a perceived better alternative. Customer is the most limited resource for the company and their loyalty directly affects its profits (Edvardsson et al., 2000). Customer behaviour is affected by several factors - culture, social conditions, family, or reference groups. It is also the personal qualities and living conditions of individuals. In terms of customer relationship management, it is important to pay attention to customer satisfaction monitoring, assess customer loyalty and customer churn. However, the digital revolution has increasingly influenced the behaviour of customers. Moving towards digital marketing and achieving a loyal customer base is a hallmark of marketing 4.0 (Kotler, Kartajaya & Setiawan, 2016). A customer-oriented company should create an "image of an ideal

customer." The absence of knowledge of the customer structure and their needs will not allow you to identify the image of an ideal client and consequently cannot build a real-life customer development strategy. The customer-oriented company strives to make customers satisfied. Customer satisfaction is accompanied by the satisfaction of other stakeholders, such as employees, intermediaries, suppliers, and shareholders. In general, satisfaction can be understood as the pleasure or frustration of the individual, which is based on a comparison of product performance and expectations (Tsiros, Mittal & Ross, 2004). Higher customer satisfaction and repeated purchases lead to customer relationship lengthening, business continuity, and loyalty. Low satisfaction leads to a change of supplier. The rate of retention depends on the competitive environment. Customer satisfaction is being addressed by many researchers.

When evaluating customer purchases, marketers can measure customer profitability not only by individual customers but also by segments or distribution channels (Chromčáková et al., 2018). Many entrepreneurs measure customer satisfaction, however, only a few entrepreneurs measure the profitability of individual customers (Niraj, Gupta & Narasimhan, 2001).

### 3 METHODS

Therefore, the basic set was represented by small medium-sized enterprises in the Moravian-Silesian Region. According to the data released by the Czech Statistical Office, 28,276 economic entities with at least 1 employee were active in the Moravian-Silesian Region as of December 31, 2018. The basic set contains most the micro-enterprises, then small and least medium-sized enterprises. In the selected sample, these relationships also apply, however not totally in terms of identical shares. The sample was created on a random basis. The respondent sample accounted for 1,446 respondents. There were most micro-enterprises, namely 831 (57%), then small enterprises in the number of 405 (28%). There were 210 (15%) medium-sized enterprises. The sample was selected on a random basis. The statistics are "slightly" distorted, as more than half of the companies have Prague as their place of residence, even though they do business elsewhere. Respondent sample consisted the most micro enterprises (up to 10 employees), then small (up to 50 employees) and least medium-sized enterprises (up to 250 employees). (Český statistický úřad, 2018)

The subject of the research was activities within the CRM architecture, both in the strategic part, as well as operational and collaborative CRM. However, for the aim of this article the research part about customer loyalty was used.

#### Method for evaluating the level of selected CRM activities

For the purpose of the research, the PDCA method was applied and modified. the individual phases of the cycle were specified, and one more option was added to the individual levels, namely the possibility of non-realization - letter W (without realization).

Tab. 2 – PDCA method. Source: Gupta (2006)

<b>W</b>	without realization	0	non-realisation of the activity
<b>P</b>	plan	1	planning the intended activity (intention)
<b>D</b>	do	2	implementation of the activity, (according to the established plan)
<b>C</b>	check	3	verifying the result of the implementation of the activity against the original intention
<b>A</b>	act	4	modifications to the intention and to the own implementation of the activities on the basis of verification and across-the-board implementation of improvements in practice.

The method was created in 1939 by American scientist Shewhart (1891-1967) and it is also used in today's business practice in various modifications (e.g. the DMAIC method). The aim

of it is constantly improving the quality of products, services, applications or processes (Gupta, 2006). The respondents' answers are evaluated based on the relative frequency of answers and mode.

### Hypotheses verification

Working hypotheses and assessment of dependence between examined phenomena were formulated in the research. Statistical hypotheses explain the relationship between the size of SMEs and selected CRM activities within the CRM architecture. Respondents were first asked how they perceived the importance of CRM, then whether they had a strategy for individual loyal customers, then how they identified loyal customers and how they deal with customer retention. These thematic areas were also reflected in the formulated hypotheses.

**H<sub>01</sub>** There is no dependence between the enterprise size and perception of the CRM importance.

**H<sub>02</sub>** There is no dependence between the enterprise size and setting of the strategy for individual loyal customers.

**H<sub>03</sub>** There is no dependence between the enterprise size and the setting up a method of determining who a loyal customer is.

**H<sub>04</sub>** There is no dependence between the enterprise size and the customer churn prediction.

For hypotheses verification were used the Pearson correlation coefficient and the correlation significance test. Four CRM activities were included in the hypotheses testing. The correlation was used to evaluate the hypotheses, namely the Pearson correlation coefficient, which expresses the interdependence between size categories of SMEs and individual selected analytical activities of CRM. The Pearson's correlation coefficient (selective correlation coefficient) is calculated as the share of the sample covariance and the product of the sample standard deviations. The value of this coefficient is the same as the population correlation coefficient (Ramík, 2003). Microsoft Excel was used for the calculation.

#### Pearson correlation coefficient:

$$r = \frac{n \sum x_{1i}x_{2i} - \sum x_{1i} \sum x_{2i}}{\sqrt{[n \sum x_{1i}^2 - (\sum x_{1i})^2][n \sum x_{2i}^2 - (\sum x_{2i})^2]}} \quad (1)$$

$n$  expresses the range of choice,  $x_{1i}$  variable values X1,  $x_{2i}$  individual variable values X2.

A high correlation coefficient value does not necessarily mean a statistically significant dependence of quantities. To test the statistical significance of correlation coefficients, test criteria with different probability distributions are used. Most commonly used is Student's distribution  $t$  with  $n - 2$  degrees of freedom (Bolboaca et al., 2006). Student's distribution is also used in this article to determine the statistical dependence of variables or to reject hypotheses formed.

## 4 RESULTS AND DISCUSSION

### Perception of the CRM importance

Customer relationship management is already an important part of any business. However, for the success of this management, it is essential that the management of the company believes in this CRM and sees it as an important part of management. Without this approach, it is unrealistic for CRM to deliver positive results. Part of our research was also finding out if CRM is perceived as an important part of the company. Responses were also taken into account in terms of company sizes. Now let's look at the results.

It is clear from the results (Table 2) that SMEs perceive CRM as very important for their business. In the case of SMEs, all respondents answered a positive response (100%). In the case of micro-sized enterprises, these positive responses were only slightly lower (97%). These results are very positive, even in the case of micro-sized enterprises. The lower share reported here may be due to the fact that CRM is in these companies at the beginning of their process and that micro-enterprises have so far unclear results of CRM operation. In general, SMEs face barriers to the development of CRM, which is exacerbated by micro-enterprises (Kmieciak, 2010).

One hundred percent of accuracy is for small and medium-sized enterprises. This answer is different only in the case of micro-sized enterprises. Three percent of micro-sized enterprises do not think that CRM is important to their business. However, they implement CRM in their company. This result may be the cause of the early implementation of CRM, whose results are still unclear or due to lack of time and staff to devote full attention to this area.

Tab. 3 – Perception of the CRM importance (%). Source: own research

Enterprise size	Yes	No
Micro	97	3
Small	100	0
Medium	100	0

### Setting of the strategy for individual loyal customers

The strategic part of CRM is the basis of this management. This part of CRM addresses various activities. One of them is precisely setting strategy for individual loyal customers. The aim of this activity is an individual approach to these key loyal customers. Of course, businesses strive for an individual approach to all customers, but the strategy for loyal customers is often different. Kozák (2011) also emphasizes various approaches to customers.

### Setting up a method of determining who a loyal customer is

The strategic part of CRM is followed by the analytical part. The analytical part focuses on the customer data analysis, their evaluation and prediction of customer purchasing behaviour. Enterprises are trying to collect all the data that they can get. Analytical CRM also allows to characterize key customers, find out their opinions and preferences (Reicher a Szeghegyi, 2015). For the purpose of this article, we have focused in the analytical part on activities dealing with the method of identifying loyal customers.

### Customer churn prediction

The analytical part of CRM also analyses the customer churn prediction. Different methods are often used for this activity. For example, the Net promoter score (NPS), which detects customer satisfaction or dissatisfaction, is an important part of customer loyalty analysis (Reichheld, 2003). Application of data mining techniques can also bring valuable customer data and behaviour. Through this survey, an enterprise can prevent a customer from leaving various activities (Fayyad et al., 1996). We will now focus on the results of each activity across the sample.

Tab. 4 – CRM activities for whole sample (WPDCA method, %). Source: own research

Activity	W	P	D	C	A
Setting of the strategy for individual loyal customers	12	13	<b>32</b>	18	25
Setting up a method of determining who a loyal customer is	<b>46</b>	15	22	11	6
Customer churn prediction	<b>52</b>	8	18	14	8

In Table 3, the answer mode is as follows (highlighted in bold). In the case of activity: setting of the strategy for individual loyal customers the mode is in phase D (32%). The largest share

of companies applies the strategy according to their plan. The second place took phase A (25%). This means that companies are correcting the strategy and trying to improve it. This is a very positive finding.

In the case of the setting up a method of determining who a loyal customer is, the mode is in phase W (46%). This means that enterprises are not doing this and they have not yet planned. A similar result is also in the case of the following activity, namely in the customer churn prediction, where the highest mode is also in phase W (52%). These results make it clear that loyal customers are divided rather intuitively.

Tab. 5 – CRM activities according to enterprise size (%). Source: own research

Activity	Micro		Small		Medium	
	W+P	D+C+A	W+P	D+C+A	W+P	D+C+A
Setting of the strategy for individual loyal customers	26	<b>74</b>	35	<b>65</b>	0	<b>100</b>
Setting up a method of determining who a loyal customer is	<b>64</b>	36	<b>54</b>	46	47	<b>53</b>
Customer churn prediction	<b>63</b>	37	<b>58</b>	42	48	<b>52</b>

Table 3 shows the results according to the size of enterprises. The first activity named: setting of the strategy for individual loyal customers is mostly in phase D, C and A. It means that the SMEs implement this activity. In the case of the setting up a method of determining who a loyal customer is, the micro-sized and the small-sized enterprises do not implement this activity. Forty-seven percent of micro-sized enterprises and 39% of small-sized enterprises even do not plan to implement this activity. Different results are in the case of medium-sized enterprises. Fifty-three percent of them implement the setting up a method of determining who a loyal customer is. The similar results are in last activity. Micro-sized and small-sized enterprises do not implement the customer churn prediction. Only medium-sized enterprises implement it.

Setting up a method of determining who a loyal customer is was supplemented by a question on how to measure loyalty in SMEs. This question offered six options for respondents. Respondents were allowed to choose one or more answers; therefore, the sum of the individual answers is not the same as the total number of respondents involved (Table 5).

Tab. 6 – Measurement of customer value in SMEs (%). Source: own research

Value	Micro	Small	Medium
Long-term relationship	<b>49</b>	<b>66</b>	<b>22</b>
Revenue value	25	19	22
Sales volume	18	9	15
Positive advertising	5	6	0
Profitability	3	0	20
Cooperation ins product/service development	0	0	21

Half of SMEs measure the value of a customer characterizing his loyalty through the length of the relationship. If we would like to look at this activity by size category, the situation is as follows (Table 4). The highest proportion of answers pertain to the length of the relationship. As many as 66% of small businesses chose this response, followed by 49% of micro-sized enterprises and 22% of medium-sized enterprises. When we look at other loyalty measurement responses, the second most frequently chosen answer is revenue value. The least used way of measuring is positive advertising and collaboration on product or service development. Positive advertising is very difficult to measure and traceable, as it can be done via social networks or WOM (word of mouth) (Sweeney et al., 2011). But let us focus on the answers of medium-sized enterprises. The results show that medium-sized enterprises use almost all possible ways outside positive advertising. Even the % shares are almost the same for each answer. Medium-sized enterprises were also the only one of the size categories that they choose the answer

regarding customer cooperation in product or service development. This result can be the result not only of the size of the enterprises, but also of the possibility of interacting with loyal customers and responsible employees involved in product development.

Surprising is also the outcome of customer churn prediction, which is a very discussed topic, especially at the academic level. Therefore, we focused on the individual sizes of the company, and even in this case there is no significant difference. Fifty percent of micro-sized enterprises, 58% of small-sized enterprises and 48% of medium-sized enterprises do not implement this activity.

### Hypotheses verification

In the third chapter were presented 4 hypotheses, which evaluate the dependence between the size of enterprises and selected activities. The table 6 shows that the coefficient  $r$  achieves a high degree of dependence for all hypotheses. Table 6 shows the results of correlation test. Regarding the significance of the correlation results, all activities are statistically significant ( $T > 1.96160$ ). It can therefore be stated that we reject all null hypotheses and accept alternative hypotheses that confirm the dependence between the size categories of SMEs and selected activities.

Tab. 7 – Test of correlation significance (%). Source: own research

CRM activity	r	T > or <critical value	Confirmation or refutation of the hypothesis
Perception of the CRM importance	0.9998	1899.71 > 1.96160	The result is statically significant – we reject $H_0$ and accept an alternative hypothesis.
Setting of the strategy for individual loyal customers	0.9871	234.28 > 1.96160	The result is statically significant – we reject $H_0$ and accept an alternative hypothesis.
Setting up a method of determining who a loyal customer is	0.9813	233.33 > 1.96160	The result is statically significant – we reject $H_0$ and accept an alternative hypothesis.
Customer churn	0.9998	1899.71 > 1.96160	The result is statically significant – we reject $H_0$ and accept an alternative hypothesis.

The highest correlation rate was reflected in case of two hypotheses ( $H_{01}$  and  $H_{04}$ ). The high correlation rate results ( $H_{01}$  and  $H_{04}$ ) are caused by all enterprises.

## 5 CONCLUSION

The aim of the article was to present the research results focus on customer loyalty as a part of customer relationship management in small and medium-sized enterprises. For the evaluation of selected activities, the modified PDCA method was used. Formulated hypotheses have been identified and evaluated by a Pearson correlation coefficient. Hypotheses were focused on the related enterprise size and selected activities (customer loyalty). The sample consisted of 1,446 respondents.

The formulated hypotheses were focused on the relationship between the size of enterprises and above-mentioned activities ( $H_{01}$ ,  $H_{02}$ ,  $H_{03}$ ,  $H_{04}$ ). The high value of the correlation coefficient and the correlation significance test confirmed the statistically significant dependence on all variables. In our research sample, we found that there is a correlation between the size of SMEs and the implementation of the research activities. This was confirmed by the relative frequency of respondents' answers and verification of hypotheses. It is interesting finding that micro, small and also medium-sized enterprises do not implement two activities - setting up a method of determining who a loyal customer is and customer churn. Only the setting of the strategy for individual loyal customer implement most enterprises.

Determining loyalty is part of customer value measurement. The last part of this article was devoted to this area. Medium-sized enterprises have been found to use almost all possible ways of measuring loyalty beyond positive advertising. Medium-sized enterprises also chose the answer to customer cooperation in product or service development as one of the size categories.

The direction of further research should be geared to further assessing the relationship between loyalty and customer relationship management to search methods to improve the quality of processes and activities within the CRM architecture and to formulate recommendations for SMEs in Czech Republic, how to improve it.

### Acknowledgement

The article was prepared based on research conducted in the context of ensuring the sustainability of the project OP VK Reg. č. CZ.1.07/2.3.00/20.0016 "Targeted research in the field of small and medium businesses to achieve a competitive knowledge economy" and student grant competition project SGS/7/2017: "Acceptance of technology from the perspective of marketing tools."

### References

- Bolboaca, S.D., & Lorentz, J. (2006). Pearson versus Spearman, Kendall's Tau Correlation Analysis on Structure-Activity Relationships of Biologic Active Compounds. *Leonardo Journal of Sciences*, 5(9), 179-200. Retrieved from [https://www.researchgate.net/publication/26449176\\_Pearson\\_versus\\_Spearman\\_Kendall's\\_Tau\\_Correlation\\_Analysis\\_on\\_Structure-Activity\\_Relationships\\_of\\_Biologic\\_Active\\_Compounds](https://www.researchgate.net/publication/26449176_Pearson_versus_Spearman_Kendall's_Tau_Correlation_Analysis_on_Structure-Activity_Relationships_of_Biologic_Active_Compounds)
- Bloemer, J.M.M., & Kasper, H.D.P. (1995). The complex relationship between consumer satisfaction and brand loyalty. *Journal of Economic Psychology*, 16(2), 311-329. doi: 10.1016/0167-4870(95)00007-B
- Dick, Alan S., & Kunal Basu, (1994), Customer Loyalty: Toward an Integrated Conceptual Framework. *Journal of the Academy of Marketing Science*, 22, 99-113. doi: 10.1177/0092070394222001
- Edvardsson, B., Johnson, M.D., Gustafsson, A., & Strandvik, T., (2000). The effects of satisfaction and loyalty on profits and growth: products versus services. *Total Quality Management*, 11(7), 917-927. doi: 10.1080/09544120050135461
- Fayyad, U.M., Piatetsky-Shapiro, G., & Smyth, P. (1996). From data mining to knowledge discovery: an overview. In U. M. Fayyad (Ed.), *Advances in Knowledge Discovery and Data Mining*. Palo Alto: AAAI Press.
- Jones, T. O., & Sasser, W. E., Jr. (1995). Why satisfied customer defect? *Harvard Business Review*, 73(6), 88-99. Retrieved from <https://hbr.org/1995/11/why-satisfied-customers-defect>
- Kmieciak, R. (2010). Systemy CRM a funkcjonowanie małych i średnich przedsiębiorstw w dotychczasowych badaniach empirycznych. Konferencja Innowacje v Zarządzaniu i Inżynierii Produkcji, Zakopane. Retrieved from [http://www.ptzp.org.pl/s80/Konferencja\\_KZZ\\_Zakopane\\_2010\\_Artykuly](http://www.ptzp.org.pl/s80/Konferencja_KZZ_Zakopane_2010_Artykuly).
- Kotler, P., Kartajaya, H. & Setiawan, I. (2016). *Marketing 4.0: Moving from Traditional to Digital*. New Jersey: Wiley.

- Kozák, V. (2011). *Budování vztahů se zákazníky: CRM v teorii a praxi*. Zlín: VeRBuM.
- Mohammadhossein, N., & Zakaria, N. H. (2012). CRM benefits for customers: Literature review (2005-2012). *International Journal of Engineering Research and Applications*, 2(6), 1578-1586. Retrieved from [https://www.ijera.com/papers/Vol2\\_issue6/IC2615781586.pdf](https://www.ijera.com/papers/Vol2_issue6/IC2615781586.pdf)
- Niraj, R. (2001). Customer Profitability in a Supply Chain. *Journal of Marketing*, 65 (7), 1-16. doi: 10.1509/jmkg.65.3.1.18332
- Oliver, R. L. (1999). Whence consumer loyalty? *Journal of Marketing*, 63, 33-44. doi: 10.2307/1252099
- Panda, T. K. (2003). Creating customer lifetime value through effective CRM in financial services industry. *Journal of Services Research*, 2(2), 157-171. Retrieved from <http://dspace.iimk.ac.in/handle/2259/552>
- Pozza, D. I., Goetz, O., & Sahut, J.M. (2018). Implementation effects in the relationship between CRM and its performance. *Journal of Business Research*, 89, 391-403. doi: 10.1016/j.jbusres.2018.02.004
- Rai, A. K. (2013). *Customer Relationship Management: Concepts and Cases*, New Delhi: PHI Learning.
- Reicher, R., & Szeghegyi, Á. (2015). Factors Affecting the Selection and Implementation of a Customer Relationship Management (CRM). *Acta Polytechnica Hungarica*, 12(4), 183-200. Retrieved from [https://www.uni-obuda.hu/journal/Reicher\\_Szeghegyi\\_60.pdf](https://www.uni-obuda.hu/journal/Reicher_Szeghegyi_60.pdf)
- Reichheld, F. F. (2003). The One Number You Need to Grow. *Harvard Business Review*, 81, 46-54. Retrieved from <https://europepmc.org/article/med/14712543>
- Sweeney JC, Soutar GN, Mazzarol T. (2011). Word of mouth: measuring the power of individual messages. *European Journal of Marketing*, 46(1/2), 237-257. doi: 10.1108/03090561211189310
- Teich, I. (1997). Holding on to customers: the bottom-line benefits of relationship building. *Bank Marketing*, 29(2), 12-13. Retrieved from <http://connection.ebscohost.com/c/articles/9703092042/holding-customers-bottom-line-benefits-relationship-building>
- Tsiros, M., Mittal, V., & Ross, W. T. (2004). The role of Attributions in Customer Satisfaction: A Reexamination. *Journal of Consumer research*, 31(2), 476-483. doi: 10.1086/422124

## Contact information

### Ing. Adéla Chromčáková

Silesian University in Opava, School of Business Administration in Karviná  
 Univerzitní náměstí 1934/3, 73340, Karviná, Czech Republic  
 E-mail: [chromcakova@opf.slu.cz](mailto:chromcakova@opf.slu.cz)  
 ORCID: 0000-0001-9143-7176

doi: 10.7441/dokbat.2019.043



# THE IMPACT OF REMUNERATION ON CEO MOTIVATION: EMPIRICAL EVIDENCE FROM THE CZECH REPUBLIC

*Kateřina Jančíková*

## **Abstract**

This article discusses the concept of the CEO's remuneration and its impact on employee motivation. This is the main prerequisite for employee satisfaction and increased loyalty to the company. This research paper provides basic theoretical knowledge in the field of remuneration and the latest research in this field in the era of digitization. The gradual rebound in industry 4.0 can also slightly vary the forms of rewards. The main aim of the article is to find the relation between the gross wage and the employee's motivation. Further dependence will be monitored between wage levels and life experience. The data for the empirical study were obtained in the Czech Republic in 2018 from a structured questionnaire survey. For this survey, 444 large manufacturing companies were approached and the questionnaire return rate was 16.89%, i.e. 75 respondents. The aim of the article is to identify and identify factors that influence the motivation of selected employees in the company - CEO. The generally existing assumption of dependence between the employee's wage and motivation will be supported by empirical evidence. The increasing wage of these workers may also be influenced by their life experiences, which the author will also try to verify and prove by empirical evidence. In the article, the author approaches the research holistically and seeks mutual relations. To verify the defined hypotheses is used Chi-square test, which demonstrated the relationship in both cases.

*Keywords:* motivation, CEO, human resources, remuneration, benefits, wage

## **1 INTRODUCTION**

Both businesses and economies are entering a new digital era, known as the knowledge economy. Automation and robotics are typical features. However, these trends cannot be applied to all company processes. An exception is, for example, the evaluation and remuneration of employees at all levels of the company. The inherent characteristic of this economic development is its global character (Stern, 2001). The new economy is based primarily on the innovation process.

The economic environment in the Czech Republic is in a phase of growth, which also reflects the development of GDP. In 2018, it grew by 3% after correcting price effects and seasonality. The rising trend is mainly due to household consumption as a result of general wage increases. This also reflects the shortage of skilled workers in the labor market. One of the solutions to this shortcoming is the implementation of industry 4.0, which is primarily based on robotization and production automation. Yet all employees in companies cannot be replaced and companies have to adapt to rapidly changing conditions. Thus, the competitiveness of companies lies not only in robotization, but also in retaining quality workers and raising the level of knowledge capital. (Fetting et al., 2018; Ematinger, 2017; Höfferová, 2019)

Another characteristic of this era is the idea of working teams, which are referred to as intellectual capital. Thus, people can also represent a specific intangible asset of a company (Mateicuiuc, 2004). This intellectual capital is concentrated in the hands of knowledge workers. They are specialized in their positions, yet are forced to work as employees of the company at all times. These knowledge workers include the management of the company. Knowledge workers are a very important part of any business and therefore businesses should strive to

retain them. One way is to create suitable working conditions and above all to continually motivate workers (Korneeva et al., 2020).

Even in the most up-to-date incentive schemes, the profit achieved plays an important role. Sufficiently large profits give companies scope for resolving potential conflicts between employers and employees and it is also a potential for managing the company's relations with the environment (Janeček & Hynek, 2010).

The first part of the article contains theoretical background to the topic, which are taken from professional databases. The second part of the paper describes proven research and data for it were obtained from a structured questionnaire survey in the business environment of the Czech Republic.

## **2 THEORETICAL FRAMEWORK**

Employee motivation is very closely linked to evaluation and remuneration. Money is still a very powerful motivation tool. Although there have been reservations in recent years about this form of remuneration (Urban, 2017), they remain a fundamental stimulus for work efforts. There are many forms of remuneration. The basic components of remuneration include wage base, personal evaluation, bonuses or bonuses and benefits (Armstrong & Taylor, 2009). These can take many forms. All employees of the organization receive these basic types of rewards. However, their amount, structure, frequency and variability depend on the job position.

The remuneration system in a company deals with the strategies, policies, and processes needed to ensure that workers receive remuneration for their work, which can take the form of cash or non-cash. The main objectives of remuneration management are to link remuneration practices to the business objectives; reward fairly and correctly; maintain highly qualified personnel; motivate employees and create a culture of high performance (Armstrong & Taylor, 2009).

As with other employees, the remuneration of top managers is composed of a financial fixed and a financial variable component of wages. Like other employees, they also receive several benefits, whether financial or non-financial benefits (McGuire et al., 2019). However, the components of executive remuneration are more frequent and complex than those of lower-level employees. Some types of rewards are unique to their profession, such as stock options, profit shares, etc. (Martin et al., 2012).

Cash rewards are still the most widespread form of reward. But they also have their limits. Janeček & Hynek (2010) claims that from a certain moment the increasing cash rewards lose their effectiveness and thus they do not sufficiently motivate the worker. The marginal benefit of the additional money received is lower than the benefit of lost time, respectively. Then the value of the effort involved. Workers who have earned a very high income and thus have sufficient personal wealth will not respond as expected to raise wages (Fisher, 2005; Gande & Kalpathy, 2017). In this case, special forms of remuneration must be introduced, which will give them the impression that they are exceptional and not every employee of the organization is entitled to them. In the case of top managers (CEOs), such forms of bonuses are, for example, royalties, options, and stock programs.

The royalties are a share of the profits of the company that may belong to the members of the governing body of the joint-stock company, at the discretion of the competent authority. In the Czech Republic, the General Meeting decides on royalties. It is, therefore, the shareholders who must decide what part of the profits accruing to them can be paid to someone else (according to agency representation). This is a relatively popular form of reward in the domestic environment (Štenglová et al., 2017). According to Klein & Coffee (2007), tying remuneration to the company's economic results in the form of royalties on a global scale is positively

assessed. As with any remuneration, this form of remuneration will have a positive effect on the performance of the manager if the criteria for assessing his performance are established in advance and the promised remuneration is fulfilled (Callan & Thomas, 2014). Unfortunately, even using this form of rewards cannot do without risk from the business perspective. The problem of hidden dividends has been revealed in both international and domestic companies, especially in private (unlisted) companies. According to Bachmann (2014), this is a situation where the majority shareholder is also a member of the body deciding on the amount of remuneration, enforces the remuneration (royalties), which are a hidden payment of the profit of the company.

The use of options and stock programs is a more modern way of motivating and rewarding CEOs (Bizjak et al. (2019). For the first time, this form of remuneration was used in the United States, precisely because of the developed capital markets that are essential to the functioning of this form of remuneration. Yermack (1995) dealt with this form of remuneration in 1995 and examined this form of remuneration in 792 companies. The general economic assumption was that equity programs reduce agency costs, as equity programs can reconcile the interests of management and owners. Unfortunately, their main advantage was suppressed, as Yermack found, because of the improper setting of these rewards. However, as has been shown in royalties, this form of remuneration may be misused. Coffee (2005) describes the negative effects of options programs when this form of remuneration has influenced the financial statements to appreciate the share price. The state could thus because of the linking of the value of shares with short-term criteria and not with long-term criteria.

Motivated workers are more self-directed than those who are not sufficiently motivated. This is also confirmed by Ryan & Deci (2000) or Thomas (2002). This suggests that these workers will be more responsible in their work and will also be more involved in the business and their jobs (Guay et al., 2000; Vansteenkiste et al., 2007) and maybe more involved (Kuvaas & Dysvik, 2009).

In the Czech Republic, most CEOs change the approach to corporate governance, owing to a general shortage of workforce. It is precisely because of the lack of skilled employees that the wage trend has been rising for several years. In addition to increasing wages and benefits, the new trend is to reduce the ratio of the variable wage component to the fixed component. Newly popular benefits are health bonuses or social benefits (e.g. old age security or childcare). Employers are also increasingly addressing the satisfaction of their employees, their development and education (PWC, 2018). As a result of the lack of people, employers increase wages and benefits by 78%, in 47% they are more interested in employee demands and in 43% they improve employees' career, development and education plans (PWC, 2018). As the benefits grow, the share of non-financial benefits such as flexible work or home office is increasing. In addition to wages and benefits, the work environment, the team, the interestingness of the job or the possibility of professional development (PWC, 2018) play a major role in job applicants' decisions.

CEOs realize the need to engage in the growing competition for skilled employees. It is necessary to know the expectations and needs that differ from one candidate to another. There are others with analysts, others with production workers, others with the 50+ generation or parents of young children. A specific group is today's young people - the so-called Millennials, who are interested mainly in corporate culture and working environment, the possibility of growth or work from anywhere, or performance evaluation with effective feedback (PWC, 2018).

To retain their employees, managers will have to take on unconventional forms of work. These will not only reflect flexible cooperation models but above all will reflect the new structure of

the economically active population. This is also evidenced by a study on the server [statista.com](http://statista.com) (Employment worldwide by 2020, by generation, 2019), which states that by 2020, the economically active population will be made up of 35% of generation Y and the same proportion will have generation X. The newly integrating generation Z among the active population will account for 24% and the Baby Boomers account for the remaining 6%. Each of the generations has its specifics and therefore the addressing and recruitment of these employees must be adapted to them. The incoming "millennium" significantly changes workers' preferences. Their priority is to work from home, use part-time work or operate based on crowdsourcing. However, a new trend that will strengthen, a relaxed work environment cannot be offered to all jobs. However, for the monitored group of workers (CEO), this knowledge can contribute to making these jobs more attractive (e.g. work on specific days, work at irregular intervals, etc.).

Generation X includes economically active people who were born in 1968-1982 and are therefore at the top. Millions, or Generation Y, are people born in 1983-1997 and are the first globalized generation. They are online and take freedom for granted, even at work. This should reflect the working conditions offered to this generation. The last generation is the Z generation and consists of people born after 1998. They are today's teenagers who have different values from other people (Šnýdrová, 2014; Forbes, 2019; Horváthová & Čopíková, 2015).

The offer of new forms of benefits and wage increases reflect the growth of the economy and the expectations of the CEOs. According to a PWC survey (2019a), 45% of Czech CEOs expect economic growth for 2019, and 7% even expect significant economic growth. Stable development assumes 31% CEO. Compared to the global CEO's survey (PWC, 2019b), which was attended by 1,300 CEOs, Czech CEOs are more optimistic about the outlook for the world economy. 70% of CEOs believe in positive or stable development globally, while this indicator reaches 85% for Czech leaders (PWC, 2019a).

To make the company attractive to the labor market, the needs of employees cannot be ignored. These priorities change over time and have a hierarchy. They are generally divided into a material (monetary) and non-material (value). And they have the greatest impact on whether the employee is looking for a new job. PWC (2019c) states that the wage addresses only the basic needs of the employee. The second component of employee satisfaction is a sense of belonging, which depends on the corporate culture. The third part is the work itself. This should be regularly renewed and must not lack elements of autonomy. Both feedback and praise should be a matter of course. If all 3 components work then the employee is satisfied. According to the Gallup Institute survey of 2017 on employee satisfaction, the second and third components lead to 87% higher exposure, business productivity up to 30%, fifth higher profits and 2.5x higher employee satisfaction (PWC, 2019c). In the last two years, the management of employee satisfaction and engagement in the Czech Republic has shifted to the level of improving employee experience under the influence of "design thinking". This approach consists of identifying the sore points of individual groups of employees. After mapping the situation, there are suggestions for improvement and implementation. Finally, the impact on employee satisfaction and motivation is monitored (PWC, 2019c).

According to the ppm factum research (2018), in which 2,680 respondents (employees) participated, 86% of respondents confirm that the state should actively favor the provision of leisure benefits. This demonstrably stimulates implementation. People who receive free time benefits from their employers confirm to a large extent that their lives are more satisfactory. The survey also shows that 49% of respondents receive meal vouchers (the most widespread benefit in the Czech Republic), 51% of respondents receive an extra week of vacation, and 44% of respondents receive a pension or pension insurance contribution. The respondents who

received contributions to leisure time benefits were 1,180. The most common form of benefit they received was a contribution to cultural events (33%), holidays (26%), sports and relaxation activities (25%) and visits to the pool or aqua park (25%).

Respondents from the ppm factum research (2018) should also indicate how satisfied they are with each aspect of their lives. A summary of this survey is given in Table 1. People who receive free time benefits from their employers confirm to a considerable extent that their lives are more satisfactory. The survey involved 500 respondents who receive free time benefits and 680 respondents who do not receive free time benefits. In all aspects of life, people are more satisfied with benefits. The biggest difference is in motivation to work, where people with benefits are 70% satisfied, while people without benefits are only 57%. The percentage of those who are dissatisfied at work is also decreasing. The numbers in bold in the table show significantly higher employee satisfaction than among people without leisure benefits.

Tab. 1 – Respondents’ satisfaction in selected aspects. Source: PPM Factum Research (2018)

Aspects of life	Receive free time benefits (n=500) (%)					Do not receive free time benefits (n=680) (%)				
	satisfied	rather satisfied	not specified	rather dissatisfied	dissatisfied	satisfied	rather satisfied	not specified	rather dissatisfied	dissatisfied
job	21	63	1	13	2	14	60	1	20	5
overall well-being	18	64	1	14	2	15	62	1	20	3
work-life balance	17	47	1	29	7	13	50	1	28	9
motivation to work	16	54	2	24	5	9	48	1	33	8
balance with stress	15	54	1	25	5	11	53	1	28	8
loyalty to the employer	23	59	3	12	3	17	60	3	15	5
performance at work	21	67	1	10	1	20	63	1	15	2
personal life	33	43	2	14	8	30	43	2	20	6

Table 2 shows the average gross wages of top management and median gross wages in the Czech Republic. This information is obtained from the data archive of the Ministry of Labor and Social Affairs. Specifically, the position of "top representatives of companies" was chosen. The trend of the last 5 years shows a growing trend in wages, which may also be affected by the growth of the business cycle. According to Stern & Willett (2014), the economy affects 50% of business performance and industry 25%, then what management achieved is 25% of business performance. For this reason, data on the development of the real gross domestic product, namely the size of the product created by companies in the manufacturing industry category (according to CZ NACE classification), were also entered. Data from this area were monitored only as a sample of respondents (or companies) that were chosen for the manufacturing industry. Data on the proportion of bonuses in the total monthly gross wage of the manager are added for complexity. 75% of the manager's remuneration in the Czech environment is made up of a fixed component. So far, the trend of a higher share of variable remuneration in CEOs in the Czech Republic is not prevailing.

Tab. 2 – Results of gross wage and median wage in the Czech Republic. Source: CSO (2019), MLSA (2018)

Year	Gross wage per month	Median gross wage	Share of bonuses in the gross wage	GDP (real for the manufacturing industry)
	EUR*	EUR	%	EUR
2018	4 756,03	2 636,64	26,80	45 080,99
2017	4 078,65	2 292,93	24,00	43 570,48
2016	4 005,95	2 205,60	24,80	39 416,01
2015	3 748,17	2 166,33	25,00	38 076,88
2014	3 675,20	2 179,92	24,00	36 193,19

**Note:** \*CZK/EUR exchange rate is 25,545 in 24.07.2019 according to Czech National Bank

The rising trend of workers' wages is not only apparent in relation to the economic growth of the country, but workers' wages are also increasing in relation to their educational attainment and life experience (Lagakos et al., 2018). The author will also try to prove this fact by empirical evidence in the business environment of the Czech Republic.

Companies not only in the Czech Republic respond to the increasing demand of employees for more personalized remuneration. In addition to the basic salary (or performance reward), more than  $\frac{3}{4}$  of companies offer employees health benefits today. More than 50% of companies offer ad hoc bonuses. Despite this, only 14% of Czech companies (8% globally) claim that their remuneration is very effective in terms of personalization and flexibility (Deloitte, 2018).

Therefore, creating the most appropriate remuneration contract is still a controversial topic, while ensuring sufficient employee motivation. Only a motivated worker is more efficient, engaged and loyal to the employer at work. Even in times of growing automation and robotics, the human factor is irreplaceable for most businesses. And if some companies could replace human power with robots and machines, surely not in top management positions. Therefore, the issue of remuneration and motivation of these workers needs to be addressed.

### 3 METHODOLOGY

The main goal of this article is to find relationships that influence the level of motivation of selected employees, which are CEOs in this article. A structured questionnaire survey was used to investigate these relationships. IBM SPSS Statistics 22 was used to process the obtained data. The Chi-square test for independence of two variables was used to verify the defined hypotheses. This test compares two parameters if they are correlated. The null hypothesis at the 95%  $\alpha$  significance level is rejected when the value of the test criterion in the critical field is realized. Thus, an alternative hypothesis is accepted (Gravetter & Wallnau, 2009; Vaughan, 2003). Subsequently, the dependence between the selected variables will be determined. For this, the rate of dependence intensity according to formula 1 will be used:

$$C_p = \sqrt{\frac{\chi_p^2}{\chi_p^2 \times n}} \quad (1)$$

Where  $C_p$  is contingency coefficient;  $n$  is number of cases;  $\chi_p^2$  is Pearson chi-square test.

The contingency coefficient measures the intensity of the relationship. Values of the coefficient range from  $\langle 0;1 \rangle$ . The closer the value is to 1, the higher the intensity of the relationship. Conversely, values close to 0 indicate low or no intensity.

The questionnaire survey was conducted in autumn 2018 and a total of 444 large companies were addressed. These companies were selected according to Commission Regulation No. 800/2008 according to the number of employees and total turnover in the previous reporting period. The condition was that the companies had more than 250 employees and their turnover was over EUR 50 million. A necessary condition was also the classification of the company according to their NACE dock in category C - manufacturing. The companies selected for the questionnaire survey were joint stock companies, limited liability companies and public companies, due to the most frequent representation in the Czech Republic. The survey involved both multinational companies and purely Czech companies. 75 respondents answered the questionnaire and the return was 16.89%. An extensive Amadeus database was used to find suitable businesses and the companies were contacted through an online questionnaire. It was divided into 4 parts and focused on ways of compensating the work of top managers and their motivation. The questionnaire contained both open and closed questions. Likert's 5-degree scales were used to obtain the opinion of respondents.

This questionnaire survey aimed to obtain objective data from a sample of respondents, which will also be sufficiently representative. When formulating the questions, the author proceeded from the generally known reluctance to provide sensitive information and thus everything was formulated so that no respondent had any reservations about the provision of information.

#### **4 RESULTS AND DISCUSSION**

From the questionnaire survey, 57 respondents (76%) think that their wages are adequate for their job position (the sum of answers is certainly yes and rather yes). All respondents know exactly when they are entitled to individual wage components, and the remuneration systems are therefore set up clearly and comprehensibly. 49 respondents (65%) are not considering changing jobs and this value is given by the sum of answers rather not and certainly not. 50 respondents (66.7%) are satisfied with the remuneration system set up, 52 respondents (69%) think that the remuneration system currently set up in the company is suitable for their job position, 55 respondents (73%) are sufficiently motivated to work. The resulting values for the last 3 statements are given by the sum of answers certainly yes and rather yes. On the optional question "What would you like to change in the remuneration system for your position?" Managers said they would like to link their remuneration more closely to the performance of the company, introduce additional earnings-related remuneration, and include it in the shareholder program, directly with the section it controls.

The initial hypothesis, which the author tries to confirm by empirical evidence, is the relationship between the manager's wage and his motivation. Despite seeking new ways of motivating these workers and moving from fixed to variable pay, wage levels are still the most important factor in motivating each worker.

To verify the defined hypothesis, a contingency table was created focusing on the manager's gross wage and his motivation for work performance. Wages were divided into intervals of CZK 25,000. The pivot table shows the relationship between the CEO's gross salary and his motivation to work. It can be observed that dissatisfaction decreases as the gross wage increases. Most respondents were in the range of gross wages 50 001 - 75 000 CZK and 125 001 - 150 000 CZK and their satisfaction with the wage level and thus also motivation to work prevails. The "Missing" column includes neutral answers of respondents, so they chose the answer I don't know. The total number of respondents was 75. The respondents' answers are summarized in Table 3.

Tab. 3 – Pivot table of wage and motivation. Source: own research

	Motivation			
	Dissatisfied	Satisfied	Missing	Total
To 50 000 CZK	4	6	1	11
50 001 – 75 000 CZK	5	11	0	16
75 001 – 100 000 CZK	3	10	0	13
100 001 – 125 000 CZK	1	4	1	6
125 001 – 150 000 CZK	2	13	1	16
150 001 – 175 000 CZK	1	4	0	5
175 001 – 200 000 CZK	1	2	0	3
Over 200 000 CZK	0	5	0	5

The manager's wage is dependent on the level of management in the company and the size of the company itself. There is currently pressure to eradicate the gender pay gap. Based on the significance of the Chi-square test, a close relationship between the variables was found at the selected significance level of 5%. This significance was 0.041. The strength of this relationship is 0.236, a slight dependence. It can, therefore, be defined that the amount of wages affects the motivation of the worker.

As reported by Ryan & Deci (2000) or Thomas (2002), employee motivation is very important. Providing motivated workers at the top management level is crucial for the company, as well-motivated workers are more responsible and engaged in the company. As stated by Kuvaas & Dysvik (2009), they are also more involved in the business, which is essential for executives.

However, rising employee wages are not merely the result of economic growth and a lack of skilled workers, which is why employers try to retain their employees. This factor of wage growth may prevail among manual workers or THP workers. Wage growth in management is usually a reflection of the worker's life experience and performance.

The second hypothesis verified in this paper is the dependence of the wage on life experience. These can be supported by age (as the time spent in the working process improves management skills and leadership skills) and the number of years spent in a given position in the company. To verify the hypothesis, contingency Table 4 was created to monitor the dependence of the gross wage of the manager and his / her life experience, which are supported for this article by age.

Tab. 4 – Pivot table of wage and age. Source: own research

	Life experience (age)					Total
	26-35	36-45	46-55	56-65	over 65	
To 50 000 CZK	2	2	4	3	0	11
50 001 – 75 000 CZK	4	9	2	0	1	16
75 001 – 100 000 CZK	3	3	5	2	0	13
100 001 – 125 000 CZK	0	2	3	1	0	6
125 001 – 150 000 CZK	1	9	5	1	0	16
150 001 – 175 000 CZK	0	3	1	1	0	5
175 001 – 200 000 CZK	0	1	0	2	0	3
Over 200 000 CZK	0	1	1	2	1	5

To verify this hypothesis was also used Chi-square test with a selected level of significance 5%. The significance of this test was 0.039 and the strength of the dependence was 0.240 (i.e. a slight dependence). It can, therefore, be defined that the manager's salary is influenced by his / her life experience, which is reflected not only in the age but also in the number of years spent in the managerial position.

If the manager's wage is a powerful motivational tool and there is a relationship between these shifts, then the author has been looking for factors that affect the wage. The first factor that



affects the amount is life experience. This premise was confirmed, confirming hypothesis no. 2. The basic prerequisite affecting the manager's wage is the size of the company. Merhebi et al. (2006) have shown in his research that there is a correlation between the size of a business and the level of manager's remuneration since it is assumed that the most capable managers hire the largest companies to maximize their productivity. Thus, the size of a business can partly determine management skills. In the author's previous research, it was also shown on empirical data that the size of the company affects the manager's salary. This dependence was monitored in terms of the number of employees of the company, which were divided into intervals. The Kendall coefficient showed a close relationship between the variables and the significance was 0.0009 (Jančíková, 2018).

Tab. 5 – Significance, value and contingency coefficient of defined hypotheses. Source: own research

	<b>Sign.</b>	<b>Value</b>	<b>Contingency coefficient</b>
<b>Hypothesis 1</b>	0,041	4,127	0,236
<b>Hypothesis 2</b>	0,039	4,254	0,240

*All values are calculated on the level of confidence 95%.*

As evidenced by studies such as Ryan & Deci (2000), Kuvaas & Dysvik, 2009 or PWC, 2018 is still a very powerful incentive for workers, as demonstrated by the empirical data presented in this paper. That is why it is very important to set up this form of motivation appropriately. Managers can receive financial rewards in many forms (Klein & Coffee, 2007; Coffee, 2005; Callan & Thomas, 2014) and some rewards can be devastating for a company under improperly set conditions (Coffee, 2005; Bachman, 2014). The benefit of financial reward is a strong and rapid motivation of the worker, however, the worker may be resistant to ever increasing financial rewards and his performance may decline.

The research gap of this concept can be seen in the identification of the business environment only in the Czech Republic. The research also focused on a limited sample of companies and the return on the questionnaire survey was lower. The field of this research can serve as a basis for more comprehensive research in which it would be compared with similar countries such as Slovakia, Poland, and Hungary. Every research contributes to deepening knowledge of this issue and finding the best contract of rewards for CEOs.

## 5 CONCLUSION

Although motivation and remuneration of workers is a frequently studied phenomenon, the results of different studies tend to be different. This may be due to different terminology of the authors, misunderstanding of the purpose of the research by the respondents (often afraid to answer questions about their wages and benefits) and last but not least mainly in the inhomogeneity of the research samples.

The study showed that CEO's motivation is dependent on wage size. Although complex rewards consisting of various forms of benefits are beginning to prevail, fixed wages are still a strong motivating factor for workers, whatever the level of the company. As further demonstrated in Table 1, variable remuneration components have been a maximum of 27% of the manager's wage over the last 5 years. The size of the wage then affects the size of the company, which was already proven in previous researches by the author. It can, therefore, be stated that the larger the enterprise, the higher the manager's remuneration. 76% of respondents in the survey stated that they are satisfied with the level of wages and 65% of respondents do not consider changing jobs. Overall, managers in selected companies are satisfied and sufficiently motivated.

## Acknowledgments

The contribution is the output of the specific research project "Vícefaktorové měření výkonnosti podniků a managementu ve vybraných odvětvích kreativních průmyslů" Internal Grant Agency of the Brno University of Technology with registration number FP-J-19-5859.

## References

- Armstrong, M., & Taylor, S. (2009). *Řízení lidských zdrojů: Moderní pojetí a postupy*. Praha: Grada.
- Bachmann, G. (2014). *Regulating the closed corporation*. Berlin: Gruyter.
- Bizjak, J. M., Kalpathy, S. L. & Mihov, V. T. (2019). Performance Contingencies in CEO Equity Awards and Debt Contracting. *The Accounting Review*, 94(5), 57-82. doi: 10.2308/accr-52317
- Callan, S. J. & Thomas, J. M. (2014). Relating CEO compensation to Social Performance and Financial Performance: Does the Measure of Compensation Matter? *Corporate Social Responsibility and Environmental Management*, 21(4), 207-227. doi: 10.1002/csr.1307
- Coffee, J. C. (2005). A Theory of Corporate Scandals: Why the U.S. and Europe Differ. *Columbia Law and Economics Working Paper*, 274(36), 1-26. Retrieved from <http://ssrn.com/abstract=694581>
- CSO (2019). *Český statistický úřad: Databáze národních účtů*. Retrieved from [http://apl.czso.cz/pll/rocenka/rocnkavyber.makroek\\_vydaj](http://apl.czso.cz/pll/rocenka/rocnkavyber.makroek_vydaj)
- Deloitte (2018). *Trendy v oblasti lidského kapitálu v České republice i ve světě*. Retrieved from <https://www2.deloitte.com/content/dam/Deloitte/cz/Documents/human-capital/2018-Trendy-v-oblasti-lidskeho-kapitalu-v-CR-i-ve-svete.pdf>
- Ematinger, R. (2017). *Von der Industrie 4.0 zum Geschäftsmodell 4.0: Chancen der digitalen Transformation*. Heidelberg: Springer-Verlag.
- Fettig, K., Gačić, T., Köskal, A., Kühn, A., & Stuber, F. (2018). Impact of industry 4.0 on organizational structures. *2018 IEEE International Conference on Engineering, Technology and Innovation (ICE/ITMC)*, 1-8. doi: 10.1109/ICE.2018.8436284
- Fischer, G. J. (2005). *How to Run Successful Incentive Schemes*. London: Kogan Page
- Forbes (2019). *Práce, jídlo, peníze a vztahy: Návod na použití generací*. Retrieved from <http://generace.forbes.cz/tabulka/>
- Gande, A., & Kalpathy, S. (2017). CEO compensation and risk-taking at financial firms: Evidence from U.S. federal loan assistance. *Journal of Corporate Finance*, 47, 131-150. doi: 10.1016/j.jcorpfin.2017.09.001
- Gravetter, F. J., & Wallnau, L. B. (2009). *Statistics for the behavioral sciences*. Belmont: Wadsworth Cengage Learning.
- Guay, F., Vallerand, R. J., & Blanchard, C. (2000). On the assessment of situational intrinsic and extrinsic motivation: the situational motivation scale (SIMS). *Motivation and Emotion*, 24(3), 175-213. doi: 10.1023/A:1005614228250
- Höfferová, M. (2019). *Trh práce v roce 2019*. In *Kurzy.cz*. Retrieved from: <https://www.kurzy.cz/zpravy/477802-trh-prace-v-roce-2019--nezamestnanost-nema-kam-klesat-prijde-utlum-ekonomiky/>

- Horváthová, P. & Čopíková, A. (2015). *Generation Y and its impact on the performance of personnel activities*. 15th International Scientific Conference Globalization and Its Socio-Economic Consequences. Žilina: University of Žilina, Faculty of Operation and Economics of Transport and Communication. Retrieved from: [https://fpedas.uniza.sk/~ke/sites/default/files/content\\_files/part\\_i\\_2015.pdf#page=217](https://fpedas.uniza.sk/~ke/sites/default/files/content_files/part_i_2015.pdf#page=217).
- Jančíková, K. (2018). The issue of remuneration of high-ranking managers in enterprises of the Czech Republic. *Trends Economics and Management*, 12(32), 87-99. doi: 10.13164/trends.2018.32.87
- Janeček, V., & Hynek, J. (2010). Motivační systém jako faktor zvyšování efektivnosti podniku. *E+M Economics and Management*, 2010 (1), 76-90. Retrieved from [http://www.ekonomie-management.cz/download/1331826764\\_0f0b/06\\_janecek.pdf](http://www.ekonomie-management.cz/download/1331826764_0f0b/06_janecek.pdf)
- Klein, W. A., & Coffee, J. C. (2007). *Business Organization and Finance: Legal and Economic Principles*. New York: Foundation Press.
- Korneeva, T. A., Potasheva, O. N., Tatarovskaya, T. E., & Shatunova, G. A. (2020). Human capital evaluation in the digital economy. *Digital Transformation of the Economy: Challenges, Trends and New Opportunities, Advances in Intelligent Systems and Computing*, 908, 66-78. doi: 10.1007/978-3-030-11367-4\_6
- Kuvaas, B., & Dysvik, A. (2009). Perceived investment in Employee Development, intrinsic Motivation and Work Performance. *Human Resource Management Journal*, 19(3), 217-236. doi: 10.1111/j.1748-8583.2009.00103.x
- Martin, G. P., Gomez-Mejia, L. R., & Wiseman, R. M. (2013). Executive stock options as mixed gambles: Revisiting the behavioral agency model. *Academy of Management Journal*, 56(2), 451-472. doi: 10.5465/amj.2010.0967
- Mateciuc, A. (2004). *K pojetí lidského potenciálu organizace*. Proceedings of the 6th International Conference MEKON 2004. Ostrava: VSB–Technical University of Ostrava, Faculty of Economics.
- Merhebi, R., Pattenden, K., Swan, P. L., & Zhou, X. (2006). Australian chief executive officer remuneration: pay and performance. *Accounting & Finance*, 46(3), 481-497. doi: 10.1111/j.1467-629X.2006.00178.x
- Ministry of Labour and Social Affairs (2018). ISPV – Informační systém o průměrných výdělcích. Retrieved from <https://www.mpsv.cz/ISPV.php>.
- PPM Factum Research (2018). *Volnočasové benefity*. Retrieved from [http://www.uzs.cz/soubory/UZS\\_AMSP\\_volno%20Das\\_benefity\\_10\\_2018.pdf](http://www.uzs.cz/soubory/UZS_AMSP_volno%20Das_benefity_10_2018.pdf)
- PWC (2018). *Český průzkum názorů generálních ředitelů 2018*. Retrieved from <https://www.pwc.com/cz/cs/temata/cesky-pruzkum-nazoru-generalnich-reditelu-2018.html>
- PWC (2019a). *CEO Survey 2019: Lidři české ekonomiky se krize nebojí, tři čtvrtiny letos předpokládají růst svých firem*. Retrieved from [https://pwc-ceska-republika.blogs.com/pwc\\_ceska\\_republika\\_news/2019/04/ceo-survey-2019-1%20C3%ADd%20C5%99i-%20C4%8Desk%20C3%A9-ekonomiky-se-krize-neboj%20C3%AD-t%20C5%99i-%20C4%8Dtvrtiny-letos-p%20C5%99edpokl%20C3%A1daj%20C3%AD-r%20C5%AFst-sv%20C3%BDch-fi.html](https://pwc-ceska-republika.blogs.com/pwc_ceska_republika_news/2019/04/ceo-survey-2019-1%20C3%ADd%20C5%99i-%20C4%8Desk%20C3%A9-ekonomiky-se-krize-neboj%20C3%AD-t%20C5%99i-%20C4%8Dtvrtiny-letos-p%20C5%99edpokl%20C3%A1daj%20C3%AD-r%20C5%AFst-sv%20C3%BDch-fi.html)
- PWC (2019b). *22nd Annual Global CEO Survey*. Retrieved from <https://www.pwc.com/gx/en/ceo-survey/2019/report/pwc-22nd-annual-global-ceo-survey.pdf>

- PWC (2019c). *Průzkum názorů generálních ředitelů top firem v Česku*. Retrieved from <https://www.pwc.com/cz/cs/temata/cesky-pruzkum-nazoru-generalnich-reditelu-2019.html>
- Ryan, R. M., & Deci, E. L. (2000). Self-determination theory and the facilitation of intrinsic motivation, social development, and well-being. *American Psychologist*, 55(1), 68-78. Retrieved from <https://psycnet.apa.org/buy/2000-13324-007>
- Statista.com (2019). *Employment worldwide by 2020, by generation*. Retrieved from <https://www.statista.com/statistics/829705/global-employment-by-generation/>
- Stern, J. M., Shiely, J. S., & Ross, I. R. (2001). *The EVA Challenge. Implementing Value-Added: Change in an Organization*. New York: Wiley & Sons.
- Stern, J. M., & Willett, J. T. (2014). A Look Back at the Beginnings of EVA and Value-Based Management: An Interview with Joel M. Stern. *Journal of Applied Corporate Finance*, 26(1), 39-47. doi: 10.1111/jacf.12052
- Šnýdrová, M. (2014). Změny struktury pracovního trhu v souvislosti s nástupem generace Y a dopady těchto změn na získávání zaměstnanců. *Ekonomické listy*, 5(3), 18-34. Retrieved from [https://www.vsem.cz/data/data/ces-soubory/ekonomicke\\_listy/Ekonomicke\\_listy\\_3\\_2014.pdf](https://www.vsem.cz/data/data/ces-soubory/ekonomicke_listy/Ekonomicke_listy_3_2014.pdf)
- Štenglová, I., Havel, B., Čileček, F., Kuhn, P., & Šuk, P. (2017). *Zákon o obchodních korporacích – Komentář*. Praha: Beck.
- Thomas, K. W. (2002). *Intrinsic Motivation at Work: Building Energy & Commitment*. San Francisco: Berrett-Koehler Publishers.
- Urban, J. (2017). *Motivace a odměňování pracovníků*. Praha: Grada.
- Vansteenkiste, M., Neyrinck, B., Niemiec, C., Soenens, B., De Witte, H., & Van den Broeck, A. (2007). On the relations among work value orientations, psychological need satisfaction and job outcomes: a self-determination theory approach. *Journal of Occupational and Organizational Psychology*, 80(2), 251-277. doi: 10.1348/096317906X111024
- Vaughan, L. (2003). *Statistical methods for the information professional*. Canada: Information Today.
- Yermack, D. (1995). Do corporations award CEO stock options effectively? *Journal of Financial Economics*, 39(2-3), 237-269. doi: 10.1016/0304-405X(95)00829-4

## Contact information

**Ing. et Ing. Kateřina Jančíková**

Brno University of Technology, Faculty of Business and Management

Kolejní 2906/4, 61200 Brno, Czech Republic

E-mail: [xpjanci01@vutbr.cz](mailto:xpjanci01@vutbr.cz)

ORCID: 0000-0002-0957-1411

doi: 10.7441/dokbat.2019.044

# ADAPTIVE NEURO-FUZZY INFERENCE SYSTEM (ANFIS) FOR FORECASTING: THE CASE OF THE CZECH STOCK MARKET

*Zuzana Janková*

## **Abstract**

The paper discusses the use of an adaptive neuro-fuzzy inference system (ANFIS) for modelling and forecasting the return of stock index in a typical financial market. Artificial intelligence models are suitable for modelling systems of complex, dynamic and non-linear relationships common in financial markets. Forecasting is performed for the PX stock index listed on the exchange of the Czech Republic with five selected variables demonstrating high interdependence with the selected index. Based on the research results it can be stated that the proposed ANFIS model is an effective system for forecasting financial time series even in a market with limited liquidity and effectiveness such as the Czech stock market.

*Keywords: ANFIS, financial market, fuzzy logic, neural networks, soft computing*

## **1 INTRODUCTION**

Stock market prediction is a classic theme not only in the financial but also in the academic sphere. Extreme stock market fluctuations, such as the global stock market slump and the economic crisis in 2018, are damaging the financial markets and, as a result of internationalization, the global economy of different parts of the world. Boyacioglu and Avci (2010) report that recent literature findings confirm that stock markets can be predicted from past returns and other macroeconomic and financial variables. However, stock market forecasting is a very complicated and difficult task. There are too many factors, such as political events, economic conditions, expectations of traders, and others, which can affect the price of stock instruments. Yudong and Lenan (2009) note that, in addition, equity instrument prices are generally very noisy, non-linear, complicated, nonparametric and chaotic by nature.

As reported by Chen et al. (2018), there is a need to develop and explore a more effective way of anticipating market fluctuations. Over the past decades, stock market forecasting has been based on quantitative methods such as autoregressive integrated moving average (ARIMA). But due to the high volatility and the non-linear data associated with it, it is difficult to achieve stock market forecasts by conventional statistical techniques, as reported by Ray et al. (2018). Currently, artificial intelligence-based methods such as fuzzy logic, artificial neural networks, or evolutionary algorithms that deliver promising results are coming to the forefront.

As stated by Tung and Le (2017) and Zadeh (1978) fuzzy logic and artificial neural network are promising techniques with extensive forecast applications. More and more scientists and researchers realize the fuzzy set theory introduced by Zadeh is a suitable instrument for mastering stock market uncertainties and ambiguities. Janková and Dostál (2019) state that fuzzy logic and artificial neural network belong among soft computing methods. The guiding principle of fuzzy logic means to the tolerance for imprecision, uncertainty, partial truth, and approximation to achieve tractability and robustness. Artificial neural network has been widely accepted mostly for its ability to learn and reveal the relationships between non-linear variables. The artificial neural network primarily overcomes the statistical regression models and allows a deeper analysis of large data sets. The created model helps in decentralization of decision-making processes to be standardized, reproduced, and documented.

## 2 ADAPTIVE NEURO-FUZZY INFERENCE SYSTEM

The architecture of the adaptive neuro-fuzzy inference system (ANFIS) uses and combines fuzzy logic and an artificial neural network. A general fuzzy inference system (FIS) consists of four main components: knowledge base, fuzzy inference system, fuzzification, and defuzzification block. Fuzzification means transformation of real variables to language variables. Dostál (2011) observes that fuzzy inference defines system behaviour using IF-THEN rules and evaluates the status of membership or truthfulness of the variable at the language level. Defuzzification is the last step, transforming the fuzzy inference results back to real values. The aim of this operation is to transform the fuzzy values of the output variable to represent the fuzzy calculation results as accurately as possible. The described fuzzy inference system structure is graphically depicted in Figure 1.

As stated by Svalina et al. (2013), the disadvantages of the fuzzy inference system (expert knowledge on the investigated issue known in advance) and the neural network (complicated understanding of complex rules) are the reason why neuro-fuzzy systems started being used as they maintain the advantages of both methods. The FIS drawback is solved by creating knowledge on the issues from the neural network system training data and the complex and complicated rules of the neural networks are bypassed by language variables that are easy to interpret. The adaptive neuro-fuzzy inference system (ANFIS) is used most frequently.

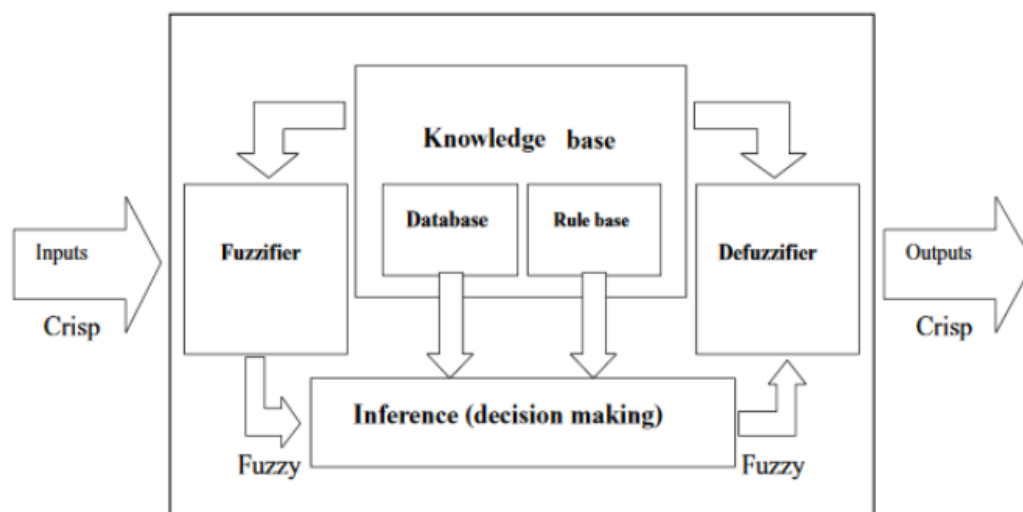

Fig. 1 – Fuzzy inference system. Source: Cheng et al. (2007)

Figure 2 depicts a multi-layer network, which includes an input layer, one or more hidden layers and one output layer, state Dostál (2011). Thanks to the multi-layer technology, neural networks are capable of better identification of non-linear relationships between input and output variable sets compared to other methods. As added by Fanta (1999), each neural network input corresponds to one variables. The neural network output is the task solution. Weights are key elements of the neural network, expressing the relative strength of input data or various connections transferring data between layers. Thus the weights express the relative significance of neural network input data. There is currently a number of various neural network architectures. Apart from the hidden structure model, there are systems with associative memory, double-layer structure, etc. In neural networks, although they are mostly based on determination by examples and not predominantly on rules, there are algorithms that help determine the neural network, i.e. change the weights of the respective neurons in the calculation process. The adaptive neuro-fuzzy inference system ANFIS architecture consists of five basic layers used in this paper is described in detail as follows: Hammer et al. (2012)

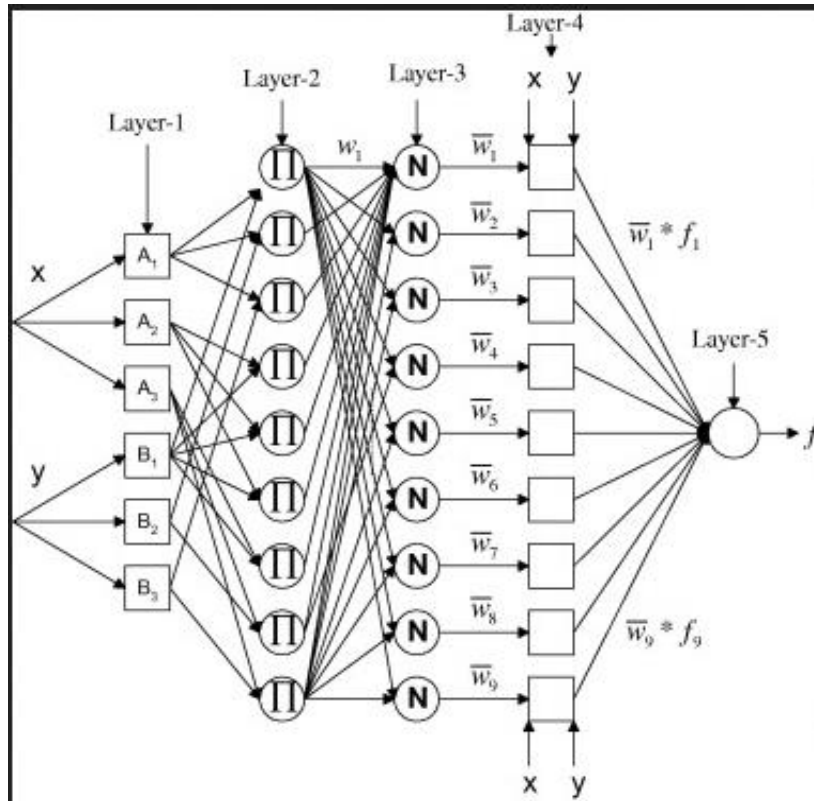

Fig. 2 – ANFIS structure. Source: Boyacioglu and Avci (2010)

### Layer 1: Input layer

The layer includes solely adaptive nodes, while each node transforms the input variable to a linguistic form (variable whose values are words in a natural language) or fuzzy sets by fuzzification and determines their membership function. The membership function in fuzzy logic assigns belongingness of sets ranging from 0 to 1, including both boundary values. More specifically, it allows to express partial belonging to a set. Fuzzy logic uses degree of veracity as a mathematical model of vagueness. The Gaussian curve is one of the most frequently used membership function shapes. For this reason, this fuzzy function type is used, same as in the survey by Esfahanipour and Aghamiri (2010). The function of each node  $i$  in this layer is given by mathematical notation:

$$O_i^1 = \mu A_i(X) \quad (1)$$

where  $X$  is the input of node  $i$ ,  $\mu A_i$  is membership function and  $O_i$  is measure of membership that input  $X$  fulfils  $A_i$ .

### Layer 2: Rule layer

This layer consists of non-adaptive nodes, with each node corresponding to one T-S fuzzy rule. The node inputs are signals from the previous layer and at input, they give weight or strength  $w_i$  of the rules whose antecedent is given by a combination of the linguistic values of the respective variables.

$$w_i = \mu A_i(X) \times \mu B_i(Y), i = 1, 2 \quad (2)$$

### Layer 3: Normalization layer

The nodes in this layer are fixed. The aim of this layer is to normalize the strength of a given rule, which is a ratio of the respective rule weight and the sum of the weights of all rules.

$$\bar{w}_l = \frac{w_i}{\sum_{i=1}^2 w_i}, i = 1, 2 \quad (3)$$

#### Layer 4: Defuzzification layer

It is a layer consisting of adaptive nodes connected to normalization nodes, while the transfer function is given by the required consequent shape.

$$\bar{w}_l f_i = \bar{w}_l (m_i X + n_i Y + q_i), i = 1, 2 \quad (4)$$

where  $\bar{w}_l$  is the normalized weight or force of the rule and  $m, n, q$  are the consequences parameters.

#### Layer 5: Summation layer

The last layer contains a single non-adaptive node that determines the overall ANFIS output based on the sum of all input signals from previous layers.

$$\sum_i \bar{w}_l f_i = \frac{\sum_i w_i f_i}{\sum_i w_i}, i = 1, 2 \quad (5)$$

### 3 METHODOLOGY AND DATA SET

The model is based on an adaptive neuro-fuzzy inference system (ANFIS) used for the prediction of the stock index listed in the Czech stock market. The data set sample used in the study has been selected from the PX stock index listed on the Prague Stock Exchange (PSE). The Prague Stock Exchange (PSE) is the largest and oldest securities market organizer in the Czech Republic. The official BCPP index is the PX Index established in 2006 by merging the PX50 and PX-D indexes. The PX Index is a price index weighted by market capitalization, consisting of the most traded stock. It currently includes the total of 12 stocks. The historical development of the PX index in the monitored period from 2010 to 2017 is shown in Figure 3.

Stock indexes can be forecasted by various fundamental, technical or psychological variables. A total of five indexes with strong correlation to the Czech PX stock index selected by a review of the previous research have been chosen for this study (Leung et al., 2000, Huang et al., 2005, Boyacioglu and Avci, 2010 and others from the literature review). One of the indexes is the VIX volatility index that demonstrates a strong negative interdependence with the PX index. Moreover, significant stock indexes in the American stock market have been selected as they affect the Czech stock market due to interlinked economy and increasing globalization. These indexes include DJIA and S&P 500. The German DAX stock index has been selected due to the strong mutual dependence of the Czech and German economies. The last input parameter is the industrial production index measuring the industrial production output. The input variables used in ANFIS are used at the time  $t-1$ .



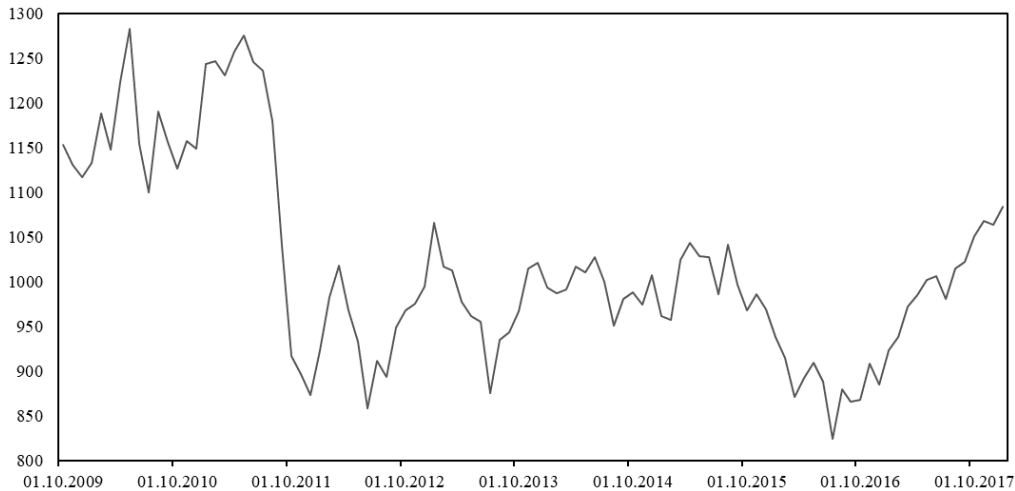

Fig. 3 – Historical development of the PX index. Source: PSE (2019)

Since the PX stock index value is high and the index differences are rather significant, which may have a negative impact on the performance of the created network, it is necessary to pre-process the original data as follows: (Boyacioglu and Avci, 2010)

$$r_t = \ln \left( \frac{y_t}{y_{t-1}} \right) \quad (6)$$

where  $r_t$  is the PX index return at time  $t$ ;  $y_t$  and  $y_{t-1}$  are monthly PX index values at time  $t$ , and time  $t-1$ .

The data were divided into two subsets: training data and testing data. There are several methods of sample division. Many authors divide data based on convenience, e.g.: 50:50, 60:40, 70:30, 80:20 or 90:10. In this study a data ratio listed as the one before last (80 observations for training and 20 for testing) due to a lower volume of the research data set.

## 4 RESEARCH RESULTS

Based on the described procedure, the best adaptive neuro-fuzzy inference system (ANFIS) results are achieved with the following parameters: (a) Generate FIS method: Grid partition, (b) Train FIS optimum method: Hybrid learning, and (c) Gaussian membership function (gaussmf). The ANFIS model can be built by dividing the input and output data into rules. This can be achieved using a number of methods. The grid partition method is chosen for this paper. Grid partition technique to generate FIS by using given training data set therefore based on the total amount and category of membership function. Grid partition approach divides data space into grids as mentioned Talupr et al. (2017).

The created ANFIS model uses the hybrid learning (training) algorithm. This learning algorithm, as reported by Loganathan and Girija (2013), combines the least-squares estimator and gradient descent method. Initially, each fuzzification neuron is assigned initial functions in the form of Gaussian distribution with certain parameters. During the training process, the training data set is presented to the ANFIS cyclically. Each cycle through all the training examples is called an epoch. In the ANFIS learning algorithm, each epoch comprises of a forward pass and a backward pass. The purpose of the forward pass is to form and adjust the consequent parameters, while that of the backward pass is to adjust the parameters of the activation functions. For this model, the number of training epochs is 10 and training error

tolerance is set to zero. The training process stops whenever the maximum epoch number is reached or the training error goal is achieved.

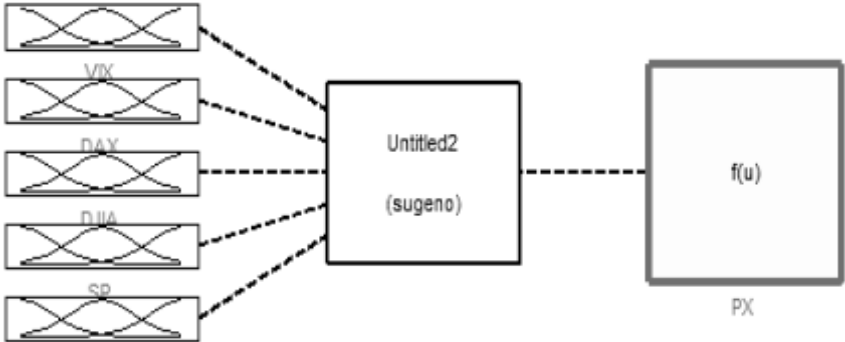

Fig. 4 – Fuzzy inference system for model. Source: own research

The Gaussian membership function has been selected based on the article by Esfahanipour and Aghamiri (2010) who used the Gaussian membership function in the ANFIS model in their research for testing data on investment instruments. Similarly, the Gaussian function is also recommended by Talpur et al. (2017). Moreover, this membership function has been selected with regard to the nature of the used data, corresponding most closely to the Gaussian distribution. In addition, three attributes (LOW, MEDIUM, HIGH) of the membership functions for the selected input variables are used.

The created model contains 243 rules forming a model decision-making mechanism. In model learning, most values are mapped to the corresponding output value. Figure 4 depicts the real FIS architecture for the designed model, consisting of five inputs, decision logic called fuzzy inference engine generates output from inputs and one input. This means the system uses the values of VIX, DAX, DJIA, S&P 500 and the industrial production index for the PX index return forecast. Figure 5 depicts the result of the ANFIS model training including the output values and the number of training data. It is obvious that the majority of the training values is close or equal to the real values. 10 iterations have been selected for the model training, with the error decreasing under the required value during the second iteration.

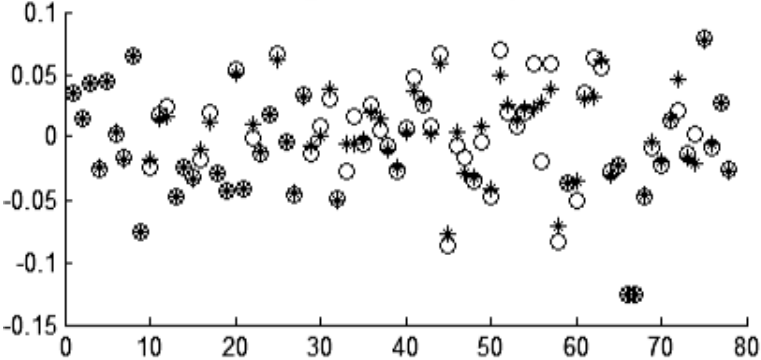

Fig. 5 – Results of the ANFIS model training. Source: own research

Quality of the designed model is tested for forecasting the PX index return development. Figure 6 presents the results of the real data and compares them to the values obtained from the ANFIS model. The figure shows the number of testing data and the adjusted predicted and real return of the PX index.

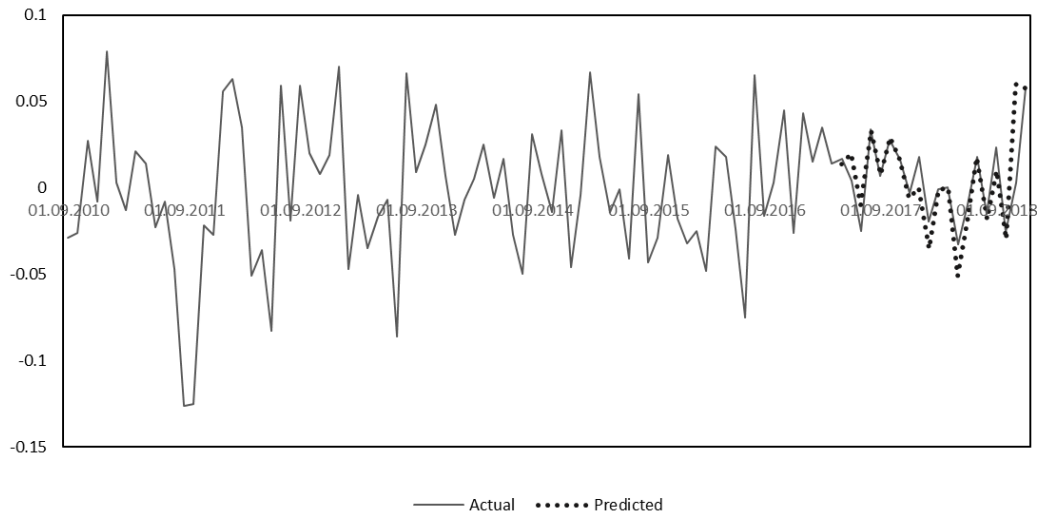

Fig. 6 – Comparison of ANFIS predicted data to current data. Source: own research

It can be noticed that the forecast of the PX index return development and therefore the ANFIS model performance is sufficient and acceptable in practice. This can be reflected by the value of the indicator root mean square error, which can be defined as the difference between the values of the input dependent variable  $a$  and the calculated values of this variable  $o$ . The calculation of the indicator consists of a procedure whereby the output is first calculated on the basis of inputs and weights. The root mean square error RMSE can be defined by a mathematical formula:

$$RMSE = \left( \frac{1}{n} \sum_{i=1}^n |a_i - o_i| \right)^{1/2} \quad (7)$$

where  $n$  is number of values,  $a_i$  is  $i$ -th value of the output and  $o_i$  is  $i$ -th the expected value. The root mean square error for the training data set is 0.0093 and the root mean square error for the testing data is 0.0448.

## 5 CONCLUSION

The presented paper discussed prediction capability and power of an adaptive neuro-fuzzy inference system (ANFIS) in a typical stock market. Stock market analysts use various technical indicators to forecast the stock market based on their personal experience. However, such indicators may give wrong business signals. For this reason, the designed model is based on fundamental factors affecting the Czech stock index development. The created set of experimental data used in the study consists of five input variables based on the performed correlation (VIX, DAX, DJIA, S&P 500 indexes and the industrial production index) and one output variable predicting the return of the PX stock index listed on the Prague Stock Exchange. The monitored period is between 2010 and 2017. The total relative error is 0.0093 and the total forecast error is 0.0448. Based on the experiment results, the proposed ANFIS model is an effective system for forecasting financial time series even in a market with limited liquidity and effectiveness such as the Czech stock market.

## Acknowledgements

The paper was compiled with the support of project No. FP-J-19-5814 – "Use of Artificial Intelligence in Business III" of the BUT Internal Grant Agency.

## References

- Boyacioglu, M. A., & Avci, D. (2010). An Adaptive Network-Based Fuzzy Inference System (ANFIS) for the prediction of stock market return: The case of the Istanbul Stock Exchange. *Expert Systems with Applications*, 37(12), 7908-7912. doi: 10.1016/j.eswa.2010.04.045
- Chen, L., Qiao, Z., Wang, M., Wang, C., Du, R., & Stanley, H E. (2018). Which Artificial Intelligence Algorithm Better Predicts the Chinese Stock Market? *IEEE Access*, 6, 48625-48633. doi: 10.1109/ACCESS.2018.2859809
- Cheng, P., Quek, C., & Mah, M. L. (2007). Predicting the impact of anticipatory action on U.S. stock market: An event study using ANFIS (a neural fuzzy model). *Computational Intelligence*, 23(2), 117-141. doi: 10.1111/j.1467-8640.2007.00304.x
- Dostál, P. (2011). *Advanced decision making in business and public services*. Brno: CERM.
- Esfahanipour, A., & Aghamiri, W. (2010). Adapted Neuro-Fuzzy Inference System on indirect approach TSK fuzzy rule base for stock market analysis. *Expert Systems with Applications*, 37(7), 4742-4748. doi: 10.1016/j.eswa.2009.11.020
- Fanta, J. (1999). *Technologie umělé inteligence na kapitálových trzích*. Praha: Karolinum.
- Hammer, M., Janda, O., & Ertl, J. (2012). Selected Soft-Computing Methods in Power Oil Transformer Diagnostics – Part 1. *Elektrorevue*, 14(3), 1-13. Retrieved from <http://www.elektrorevue.cz/cz/clanky/energetika--vykonova-elektronika--elektrotechnologie/30/vyuziti-vybranych-soft-computingovych-metod-v-diagnostice-vykonovych-olejovych-transformatoru---1--cast/>
- Huang, W., Nakamori, Y., & Wang, S. Y. (2005). Forecasting stock market movement direction with support vector machine. *Computers & Operations Research*, 32(10), 2513-2522. doi: 10.1016/j.cor.2004.03.016
- Janková, Z., & Dostál, P. (2019). Decision-Making Process Using Neuro-Fuzzy Model for Capital Market. In *Perspectives of Business and Entrepreneurship Development: Digital Transformation of Corporate Business*, 175-182. Brno: Faculty of Business and Management, Brno University of Technology.
- Leung, M. T., Daouk, H., & Chen, A. S. (2000). Forecasting stock indices: A comparison of classification and level estimation models. *International Journal of Forecasting*, 16(2), 173-190. doi: 10.1016/S0169-2070(99)00048-5
- Loganathan, C., & Giriya, K. V. (2013). Hybrid Learning For Adaptive Neuro Fuzzy Inference System. *Research Inventy: International Journal of Engineering and Science*, 2(11), 6-13. Retrieved from <http://www.researchinventy.com/v2i11.html>
- PSE (2019). Indexy. In *Prague Stock Exchange*. Retrieved from <https://www.pse.cz/indexy>
- Ray, R., Khandelwal, P., & Baranidharan., B. (2018). A Survey on Stock Market Prediction using Artificial Intelligence Techniques. In *2018 International Conference on Smart Systems and Inventive Technology (ICSSIT)*, 594-598. India: IEEE. doi: 10.1109/ICSSIT.2018.8748680
- Svalina, I., Galzina, V., Lujčić, R., & Šimunović, G. (2013). An adaptive network-based fuzzy inference system (ANFIS) for the forecasting: The case of close price indices. *Expert Systems with Applications*, 40(15), 6055-6063. doi: 10.1016/j.eswa.2013.05.029
- Talpur, N, Salleh, M. N. M., & Hussain, K. (2017). An investigation of membership functions on performance of ANFIS for solving classification problems. *IOP Conference Series:*

*Materials Science and Engineering*, 226(1), 1-7. doi: 10.1088/1757-899X/226/1/012103/

Tung, K., T., & Le, M. H. (2017). An Application of Artificial Neural Networks and Fuzzy Logic on the Stock Price Prediction Problem. *International Journal on Informatics Visualization*, 1(2), 40-49. doi: 10.30630/joiv.1.2.20

Yudong, Z., & Lenan, W. (2009). Stock market prediction of S&P 500 via combination of improved BCO approach and BP neural network. *Expert Systems with Applications*, 36(5), 8849-8854. doi: 10.1016/j.eswa.2008.11.028

Zadeh, L. A. (1978). Fuzzy sets as a basis for a theory of possibility. *Fuzzy Sets and Systems*, 1(1), 3-28. doi: 10.1016/0165-0114(78)90029-5

### **Contact information**

**Ing. et Ing. Zuzana Janková**

Brno University of Technology, Faculty of Business and Management

Kolejní 2906/4, 61200 Brno, Czech Republic

E-mail: Zuzana.Jankova@vutbr.cz

ORCID: 0000-0003-1798-5275

doi: 10.7441/dokbat.2019.045

# SUSTAINABLE TOURISM: ANTECEDENT DIMENSIONS AND FUTURE AGENDA

*Mohsin Javed, Zuzana Tučková*

## **Abstract**

This study attempts to provide basic understanding of tourism and sustainability based on the existing literature and provides research agenda for future work based on existing gaps. In the contemporary era, tourism is a fascinating aspect of our lives along with a lot of interrelated industries and complexed relationships. The literature indicates that antecedent dimensions of sustainable tourism (environmental, socio-cultural, and economic dimensions) are common and prevalent, however, this study invites to depart from the traditional dimensions and suggest to include two new dimensions of sustainability (infrastructural and technological dimensions). The study also suggests the assessment and validation criteria including structural equation modelling (SEM) in the development of sustainability indicators. These findings will be helpful to move towards developing comprehensive and exhaustive set of indicators by future researchers.

*Keywords: antecedent dimensions, future agenda, sustainable tourism*

## **1 INTRODUCTION**

The travel and tourism is a fascinating industry with globally dynamic growth. The management and business of tourism is related with the organization of journeys and catering of the needs at the tourist destinations (Holloway & Taylor, 2006). Until first half of the twentieth century, professional approach was not adopted towards tourism industry, the expansion of 1960s and 1970s enticed the world to adopt the tourism seriously as a discipline and industry, therefore the era after 1950s to twenty-first century is considered as the era of popular tourism (Holloway & Taylor, 2006). Available data showed a growth of international tourist arrivals is even outstanding from 1980s with the continued rising trend till the present time. Moreover, there were 25 million international tourist arrivals in 1950, but this figure was exceeded by 1300 million in the year 2017 (WTO, 2018). However, at the same time the tourism industry is a very complex field with multiple stakeholders and interrelated industries such as airlines, hotels, natural areas and attractions etc. This dynamic branch requires cooperation among private sector, public sector, and all other stakeholders to sustain in the long-run (Tučková & Jurigová, 2014). The role of tourism is undeniable due to its capacity of having cultural representation, jobs creation, economic growth and development. Globally, 10 percent of world jobs are due to tourism industry. Furthermore, the share of tourism industry is 10.4 percent of world's GDP (World Travel & Tourism Council, 2019).

The development of the tourism industry and recognition as a discipline is quite in line with the growth of tourism. The growth of tourism in the 1950s also contributed in the recognition of the value of leisure activities as policymakers and scholars began to recognize the emerging significance of tourism. Hence, the prior investigations also helped in the development of the concept of tourism as a field of study with the recognized impacts on economies, communities and environments (Robinson, Luck & Smith, 2013).

As indicated above, this widespread travelling also caused some problems with reference to environmental damage, socio-cultural issues and economic impacts. Therefore, future sustainability and competitiveness have received much attention and is an issue of considerable

debate over the last two decades. Some of the impacts of tourism are positive such as enhancing understanding across cultures, however, the resulting pollution and harm to the environment due to irresponsible behaviour of tourists is enormous and alarming (Patterson, 2016). That is why the concept of sustainable tourism has got considerable attention by researchers and policy makers. This concept of sustainable tourism emerged in 1980s that refers to the low impact on environment and local culture while helping to generate future employment for local people, tourism companies and tourists themselves. It establishes a balance between the conserving biodiversity whilst maximizes the positive contribution of tourism to biodiversity conservation and thus to poverty reduction and the achievement of common goals towards sustainable development.

The tourism industry which is basically the part of service industry share the characteristics, such as intangibility, heterogeneity, inseparability, perishability, and lack of ownership (Robinson, Luck & Smith, 2013). Therefore; the state of industry, competitiveness and stakeholder's behaviour matter a lot for sustainability and long-term growth. In order to tackle these issues and come up with sustainability and competitiveness, there is need to understand sustainable tourism in a better way. An exhaustive approach should be adopted and the concept should be peeped from a wider theoretical lens to cover wider spectrum affecting the tourism sustainable. This research put efforts to address these issues and fill the research gaps related to the exhaustiveness and comprehensiveness of sustainable tourism, with some suggestions for future research.

## **2 LITERVIEW REVIEW**

### **2.1 Tourism and Sustainability**

Tourism has played its role in the countries' GDP and employment, economic growth and development, socio-cultural understanding and sometime in environment conservation policies. However, the widespread traveling caused many problems, like degradation of environment, harm to the social life, and low involvement of local residents in the tourism business. These issues emerged the debate and gave birth to the concept of sustainable tourism in 1980s. From that time, the concept and issue of sustainable tourism is in debate with respect to theory and practice.

In 1995, WTO (World Tourism Organization) played its leadership role in the field of sustainable tourism, by establishing a task force and 11 core indicators have been identified by the WTO process for sustainable tourism management which includes site protection, stress, use intensity, social impact, development control, waste management, planning process, critical ecosystems, consumer satisfaction, local satisfaction and tourism contribution to local economy. However, these WTO indicators are 'demand driven' and are helpful for managers to make decisions of practical nature.

Much of the literature discusses the issue of tourism as well as its sustainability along with related concerns. For example, Blancas, Lozano-Oyola, and González (2015) presented analytical tools to address the two key issues, which European Commission considers to provide a better base of socio-economic knowledge and improved image as quality sustainable tourism destinations of European areas. They defined a system of sustainable tourism indicators and obtained a composite indicator having weights as well as sustainable tourism country brand ranking. While Ziaabadi et al. (2017) determined the sustainability and indicators of sustainable tourism by using a composite indicator and a linear programming model. They explored that situation for sustainable tourism is not appropriate and environmental health is even having

lowest level of sustainability as compared to social and economic aspect. So the issue of sustainability in tourism should be considered seriously and more attention should be paid.

In the same way, Lee and Hsieh (2016) identified indicators of sustainable tourism. They explored key dimensions and indicators by using fuzzy Delphi method and examined weights by using the analytic hierarchy process. The process revealed 141 indicators for sustainable tourism. Based on stakeholder theory and environmental impact theory for incorporating stakeholder's roles in assessment of sustainable tourism, they examined indicators and came with the need to foster stakeholder involvement as well as better planning for sustainable tourism.

There was the need to analyse residents' perceptions about sustainable tourism initiatives so Boley, McGehee, and Hammett (2017) examined the sustainable tourism initiatives with respect to residents' perceptions across three US counties and found uniformly high levels of importance towards sustainability but these residents have varied perceptions of performance. They also have discussed methodological and theoretical considerations and showed importance performance analysis (IPA) within social exchange theory as well as oliver's expectancy-disconfirmation paradigm. To analyse the sustainability achievement at destination level, a study of Ng et al. (2017) evaluated the sustainability achievement of Tioman Island by using sustainable Ecotourism Indicator system (SEIS) which considers sustainability if stakeholders make a positive contribution to one another. They carried out the study by designing three versions of questionnaire and found Tioman Island potentially sustainable with 58.89%.

Dedeke (2017) explored the creation of a sustainable tourism business in the Amazon forest. He found that the process proposed by actor-network theory (ANT) have been followed and form principal actor the ability of learning new thing, capacity to adapt changes and participation of experts plays role in success. Analysing in a different way, Dvarskas (2017) described one approach for connecting recreational visitor behaviour with an ecological model that captures the negative effect of increased visitors upon the environment. He came with the conclusion that the resilience of a tourist destination plays important role in sustainability because of increasing tourist numbers. He has also given directions for future work such as additional model components, refinement of the relationships and its application in additional areas.

Although tourism is a source of revenue and growth yet adverse impacts are much concerning issue for its sustainability, the same issue addressed by Paramati, Shahbaz, and Alam (2017) and they investigated the impact of tourism on economic growth and emission of carbon dioxide in eastern and western EU countries. They found that there is relationship among the variables and tourism stimulates economic growth in both western and eastern EU countries. Interestingly, they found that tourism increases CO<sub>2</sub> emissions in eastern countries but reduces in western countries of EU and it only depends on the sustainable tourism policies and good management. One country-focused study of Brendehaug (2017) is good to analyse policy shift of Norwegian government and he examined how sustainability can be integrated in tourism planning due to the shift of Norwegian government from sector approach to integration approach. By applying the integration of environmental policy concept, they showed that sustainable tourism is partially integrated with three issues that Norway has weak structure for policy integration and sustainable tourism integration is stimulated by bottom-up integration and national horizontal integration as well as they found no evidence for this shift for sustainable tourism from sector approach to integration approach.

The exploratory study conducted by Romolini, Fissi, and Gori (2017) to analyse the phenomenon of albergo diffuso (AD) model and found that considerable investment is required



for structural renovation and greatest importance of sustainability and stakeholder relations as well as they identified that Italian Ads are small but considers communications, marketing policy and use of digital technology.

Furthermore, small and medium sized tourism enterprises can play their role in sustainability, a study focusing this conducted by Coles et al. (2017), they analysed about environmental resources and costs in business model of small and medium sized tourism enterprises. They reported that economic and environmental performance in case of sustainable tourism discourse is overlooked. They stressed with strong evidences that in environmental management by SMTE's contemporary approaches should consider the current and changing conditions to form business models. In another such type of study, Borden, Coles and Shaw (2017) investigated the initiatives of small and medium sized enterprises and their impacts on the guest experience. By interviewing 16 SMTE managers and 408 guests, cluster analysis result showed that in water use segments one cluster focused to increase return on investment while guests reported that these initiatives are not operationally viable. They found that two initiatives suggested by managers are viable and appropriate.

The above-mentioned literature indicates the current status and importance of sustainable tourism as the three aspects of sustainable tourism must be in a good balance for future growth and sustainability of tourism. The better understanding of sustainable tourism, determination of sustainability, different factors and indicators and better practices in this regard can play the vital role for the future sustainability of tourism.

## **2.2 Global initiatives and Sustainable Tourism**

There is a dire need for integration in support of global initiatives, and United Nations' 2030 agenda for sustainable development is at top for the consideration of tourism and sustainability. In 2015, the General Assembly of United Nations adopted the 2030 agenda and its 17 sustainable development goals to end poverty, protect the planet and ensure prosperity for all. Tourism is included in the sustainable development goals (SDGs) in the introduction, as well as a target in Goal 8 (promote sustained, inclusive and sustainable economic growth, full and productive employment and decent work for all), in Goal 12 (sustainable consumption and production patterns), and Goal 14 (conserve and sustainable use of the oceans, seas and marine resources). So, the key role of sustainable tourism is explicitly mentioned in three of the 17 sustainable development goals. The 10-Year Framework of Programs (10-YFP) on sustainable consumption and production patterns is also at the forefront, which is a global commitment to accelerate the shift towards sustainable consumption and production in both developed and developing countries, adopted in 2012 at the World Summit on sustainable development (General Assembly of United Nations, 2015).

The 20 indicators proposed by Eurostat (directorate-general of European Commission) in 2006 are also worthwhile to mention, covering economic, environmental and social domains however are intended to be applied at regional level only (European Commission, 2007). The OECD workshop in 2010, also showed concern by highlighting three major challenges for sustainable tourism which are climate change, resource conservation and social cohesion and these issues requires attention at the regional and well as national level (OECD, 2010).

The European Tourism Indicator System (ETIS) launched by the European Commission, has defined 43 core indicators and has been trailed in NECSTouR regions (Network of European Regions for Sustainable and Competitive Tourism) and other destinations are very encouraging as an example of best practice (European Commission, 2016).

### 2.3 Indicators of Sustainable Tourism

The concept of sustainable tourism needs good and clear indicators for measurability and assessing the impacts of tourism. In tourism planning, policies and management, sustainable development is a prevailing paradigm (Bianchi, 2004; Bramwell & Lane, 1993). The sustainability of tourism is more than just physical environment and covers different aspects (Bramwell & Lane, 2008; Holden, 2003). At the same time Sustainable tourism is a controversial concept (Liu, 2003; Sharpley, 2009) but indicators are important to measure the impacts of tourism (Wheeller, 1993). Therefore, the formulation of indicators is necessary for practices and research of sustainable tourism. Indicators provide essential information regarding sustainable tourism and an operative framework with policy relevance (Hezri & Dovers, 2006).

The focus on the use of indicators is increasing to assess the level of sustainability since United Nations Earth Summit of 1992 and as a result international organizations suggested different indicators from time to time (Rebollo & Baidal, 2003). The main purpose of all such efforts is to keep the growth of tourism in limits (Holden, 2016; Hunter, 1995). The literature refers indicators as a necessary tool to measure sustainability by monitoring development in the tourism sector (Castellani & Sala, 2010; Crabtree & Bayfield, 1998; Dahl, 1995; Gahin, Veleva, & Hart, 2003; Smeets & Weterings, 1999; Valentin & Spangenberg, 2000) and communicating the knowledge in the form of reliable data on tourism (Blackstock et al., 2006; Blancas et al., 2010; Roberts & Tribe, 2008; Sanchez & Pulido, 2008; WTO, 1995).

The first work on tourism in terms of sustainability and indicators development is of the International Federation of Tour Operators under the project of the European Community Models of Sustainable Tourism in the year 1994 (Hughes, 1994). Then, the guidelines of indicators provided by World Tourism Organization in 1995 as well as an updated version in 2005 which is being regarded as a very helpful guidebook for researchers and the relevant stakeholders (WTO, 1995; WTO, 2004). Furthermore, the indicators developed by German Federal Environment Agency in 2001, the headline indicators by English Tourism Council in 2002 as well as national indicators by French Institute for Environment are worthwhile to mention in the tourism literature. These indicators and such other country-specific indicators developed by other researchers are providing a guideline for sustainability monitoring and measurement in the tourism industry. However, these indicators are not without problems as these varies with the stakeholder needs and place and the type of dimension under consideration and indicators should follow certain characteristics for convenience, to make them effective and user-friendly. Despite these developments, still there is less consensus of the issue of sustainability, its exact meaning and components (Bell & Morse, 2008; Tsaur & Wang, 2007; Weaver & Lawton, 1999) while some consider it unachievable target and immeasurable goal (Ko, 2005) so logical assessment methodologies are much needed for higher validity and reliability to build and increase confidence on the results for decision making due to the dynamic and unpredictable nature of the tourism industry (Asmelash & Kumar, 2019). Sustainability of tourism does not refer a single form but all the aspects related to the tourism industry should be sustainable (Sedai, 2006) and tools developed to assess the impacts are not adequate as well (Asmelash & Kumar, 2019) which hinders the practical assessment of sustainability (Choi & Sirakaya, 2005; Ko, 2005). In addition, the assessment of tourism sustainability with real cases is also not well-developed (Ko, 2005; Cernat & Gourdon, 2012, Choi & Sirakaya, 2005) and despite having a lot of indicators in the literature, a very few have been practically implicated and evaluated (Reihanian et al., 2015; Blancas et al., 2010; Rebollo & Baidal, 2003; Lee & Hsieh, 2016). Although Ko (2005) developed a comprehensive methodology for the assessment of sustainable tourism yet a very few scholars followed this model. A practical model has also been developed for the assessment of sustainable tourism in

Iran (Mahdavi, Parishan & Hasar, 2013). Most past studies focused on the traditional dimensions of the sustainable tourism, i.e., economic, socio-cultural, and environmental (Dubois, 2005; Schianetz & Kavanagh, 2008) or some added also institutional sustainability.

Despite this existing literature on tourism and sustainability with considerable work on the level of organization and academia, their use has been hampered by technical and conceptual difficulties (Torres-Delgado, 2014; Ceron & Dubois, 2003; Vila, Costa & Rovira, 2010). Similarly, a single set of indicators cannot be used for every destination, as there is no consensus among scholars (Cernat & Gourdon, 2012; Fernández & Rivero, 2009). Therefore, careful assessment is also needed for higher validity and reliability to ensure robustness and this assessment has been overlooked in the majority of previous studies (Reihanian et al., 2015), while some authors such as Choi & Sirakaya (2005), and Ap & Crompton (1998) considered these issues and recommended the application of Structural Equation Modeling (SEM). This study will consider such aspects for higher robustness by using SEM. Furthermore, Asmelash & Kumar (2019) departed from the traditional three dimensions of sustainable tourism and considered institutional sustainability. However, total variance explained is of moderate level (49.008%) so these authors suggested including some additional dimension of sustainability, such as infrastructural sustainability and technological sustainability along with respective indicators to improve the total variance explained. Therefore, these studies will fulfil the said research gap by introducing two new dimensions of sustainable tourism along with respective indicators in an attempt to improve and moving towards exhaustive approach.

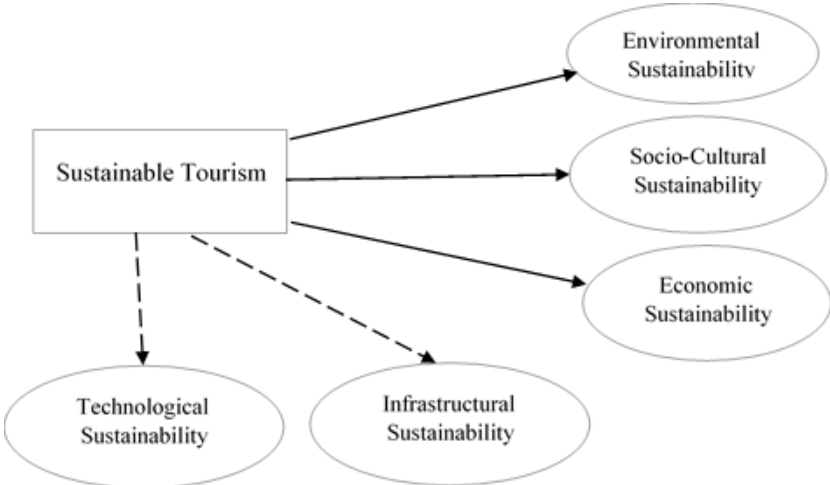

Fig. 1 – Traditional Versus Suggested New Dimensions of Sustainable Tourism. Source: own research

Note: Continuous lines indicate traditional dimensions, dashed lines indicate new dimensions.

**3 RESEARCH METHDOLOGY**

Depending upon the previous literature review and research gaps found, there could be future studies addressing the aforementioned areas of concern with the following research methodology to develop indicators for addressing and measuring sustainable tourism. Even today, especially in the developing countries, the tourism business is not following the contemporary way of action in providing quality services with less dissemination of information among tourism stakeholders to achieve sustainability. Therefore, to be exhaustive in the indicator selection, both qualitative (expert judgement) and quantitative (survey) methods. The study is expected to be carried out in the selected cities of Pakistan (Islamabad, Lahore, and Faisalabad), and have suggestion to be carried out in other locations for developing indicators suitable to the local environment, by adopting the following steps.

### **Step 1: Indicators development procedure**

The list of indicators can be prepared by the careful examination of previous studies as well as by conducting semi-structured interviews. It is obvious that the list of indicators might end up with more indicators than required and recommended by WTO (2004) and Sors (2001). So, the Delphi method can be used to reduce the number of indicators by including experts of the relevant field. In Delphi method, the panel of experts will include the tourism professors, and heads of the tourism department for benefitting from their expert opinion and professional approach.

### **Step 2: Purification of the indicator development**

The purification of the indicators can be done by conducting a pilot study to receive relevant feedback and avoid any ambiguity related to the research instrument (Choi & Sirakaya, 2005). For this purpose, the questionnaire can be distributed to 300 respondents including local residents, tourists and tourism experts, by the way of convenient sampling method with the request to rate the indicators on Likert scale (anchored at 1 = strongly disagree, 2 = disagree, 3 = neutral, 4 = agree, and 5 = strongly agree). As this study has the recommendations for the use of structural equation modelling (SEM), therefore, the sample size 300 is adequate enough for such type of analysis, and this sample size is even more than the recommended sample size of 200 (Kline, 2013; Byrne, 2010; Iacobucci, 2010).

### **Step 3: Verification of the indicator development**

The verification of the indicator development can be done by the total variance explained (TVE) and this TVE is considered better to be more than 60 percent. Further, the reliability of the indicators can be analysed by the value of Cronbach's alpha as well as sample adequacy by the Kaiser-Meyer-Olkin (KMO).

### **Step 4: Assessment and validation of the indicator development**

The assessment of indicators is important to see the multivariate normality and this is quite common by using Q-Q plot as well as the multicollinearity by the value of determinant. Furthermore, the validation of the indicators can be done by checking for internal reliability, composite reliability and validity analysis (convergent validity, discriminant validity, and content validity) through confirmatory factor analysis.

## **4 CONCLUSION, IMPLICATIONS, AND FUTURE STUDIES**

The purpose of this study was to provide basic understanding of sustainable tourism by reviewing the literature to familiarize with the current status of tourism in terms of sustainability. In addition, the study considers contemporary focus of research, and possibility of future research on sustainability, by offering suggestions for capturing the exhaustive picture in measuring sustainable tourism. The study found that conventional approach towards sustainable tourism came up with three dimensions (environmental, socio-cultural, and economic dimensions). These three dimensions have their impacts on tourism, which might be positive or negative. By considering all such factors, the literature suggests some indicators to mitigate such impacts and create a balance for long-term sustainability. However, this study suggests departing from the traditional stand and invites to include some more dimensions of sustainability including infrastructural sustainability and technological sustainability along with the suggested assessment and validation approach. The collected indicators (for traditional dimensions, as well as new dimensions) from the literature will help to formulate list used in the Delphi method for reaching at the level of agreement and consensus. Hence, the future studies should consider these important issues and develop new indicators. These indicators are

of multidisciplinary nature and therefore the selection and choice of indicators should be done with care and future researchers should be cautious in this regard whilst suggesting indicators related to the new dimensions.

## **Aknowledgement**

The authors are grateful for the financial assistance provided by the Internal Grant Agency of FaME, TBU No. IGA/FaME/2018/009, titled, “HRM application as a source of organizational performance in tourism services in the context of sustainable tourism”.

## **References**

- Ap, J., & Crompton, J. L. (1998). Developing and testing a tourism impact scale. *Journal of travel research*, 37(2), 120-130. doi: 10.1177/004728759803700203
- Asmelash, A. G., & Kumar, S. (2019). Assessing progress of tourism sustainability: Developing and validating sustainability indicators. *Tourism Management*, 71, 67-83. doi: 10.1016/j.tourman.2018.09.020
- Bell, S., & Morse, S. (2008). *Sustainability indicators Measuring the immeasurable?* London: Sterling.
- Bianchi, R. V. (2004). Tourism restructuring and the politics of sustainability: A critical view from the European periphery (The Canary Islands). *Journal of Sustainable Tourism*, 12(6), 495-529. doi: 10.1080/09669580408667251
- Blackstock, K., McCrum, G., Scott, A., & White, V. (2006). *A framework for developing indicators of sustainable tourism*. Retrieved from <https://macaulay.webarchive.hutton.ac.uk/ruralsustainability/FrameworkReport.pdf>
- Blancas, F. J., González, M., Lozano-Oyola, M., & Perez, F. (2010). The assessment of sustainable tourism: Application to Spanish coastal destinations. *Ecological indicators*, 10(2), 484-492. doi: 10.1016/j.ecolind.2009.08.001
- Blancas, F.J., Lozano-Oyola, M., & González, M. (2015). A European Sustainable Tourism Labels proposal using a composite indicator. *Environmental Impact Assessment Review*, 54, 39-54. doi: 10.1016/j.eiar.2015.05.001
- Boley, B. B., McGehee, N. G., & Hammett, A. T. (2017). Importance-performance analysis (IPA) of sustainable tourism initiatives: The resident perspective. *Tourism Management*, 58, 66-77. doi: 10.1016/j.tourman.2016.10.002
- Borden, D. S., Coles, T., & Shaw, G. (2017). Social marketing, sustainable tourism, and small/medium size tourism enterprises: challenges and opportunities for changing guest behaviour. *Journal of Sustainable Tourism*, 25(7), 903-920. doi: 10.1080/09669582.2016.1270952
- Bramwell, B., & Lane, B. (2008). Priorities in sustainable tourism research. *Journal of Sustainable Tourism*, 16(1), 1-4. doi: 10.2167/09669580803489612
- Bramwell, B., & Lane, B. (1993). Sustainable tourism: An evolving global approach. *Journal of Sustainable Tourism*, 1(1), 1-5. doi: 10.1080/09669589309450696

- Brendehaug, E., Aall, C., & Dodds, R. (2017). Environmental policy integration as a strategy for sustainable tourism planning: issues in implementation. *Journal of Sustainable Tourism*, 25(9), 1257-1274. doi: 10.1080/09669582.2016.1259319
- Byrne, B. M. (2010). *Structural equation modeling with AMOS: Basic concepts, applications and programming*. New York: Routledge.
- Castellani, V., & Sala, S. (2010). Sustainable performance index for tourism policy development. *Tourism management*, 31(6), 871-880. doi: 10.1016/j.tourman.2009.10.001
- Cernat, L., & Gourdon, J. (2012). Paths to success: Benchmarking cross-country sustainable tourism. *Tourism Management*, 33(5), 1044-1056. doi: 10.1016/j.tourman.2011.12.007
- Ceron, J. P., & Dubois, G. (2003). Tourism and sustainable development indicators: The gap between theoretical demands and practical achievements. *Current Issues in Tourism*, 6(1), 54-75. doi: 10.1080/13683500308667944
- Choi, H. S. C., & Sirakaya, E. (2005). Measuring residents' attitude toward sustainable tourism: Development of sustainable tourism attitude scale. *Journal of Travel Research*, 43(4), 380-394. doi: 10.1177/0047287505274651
- Coles, T., Warren, N., Borden, D. S., & Dinan, C. (2017). Business models among SMTEs: identifying attitudes to environmental costs and their implications for sustainable tourism. *Journal of Sustainable Tourism*, 25(4), 471-488. doi: 10.1080/09669582.2016.1221414
- Crabtree, B., & Bayfield, N. (1998). Developing sustainability indicators for mountain ecosystems: a study of the Cairngorms, Scotland. *Journal of Environmental Management*, 52(1), 1-14. doi: 10.1006/jema.1997.0159
- Dahl, A. L. (1995). *Towards indicators of sustainability*. Wuppertal: United Nations.
- Dedeke, A. N. (2017). Creating sustainable tourism ventures in protected areas: An actor-network theory analysis. *Tourism Management*, 61, 161-172. doi: 10.1016/j.tourman.2017.02.006
- Dubois, G. (2005). Indicators for an environmental assessment of tourism at national level. *Current Issues in Tourism*, 8(2-3), 140-154. doi: 10.1080/13683500508668210
- Dvarskas, A. (2017). Dynamically linking economic models to ecological condition for coastal zone management: Application to sustainable tourism planning. *Journal of Environmental Management*, 188, 163-172. doi: 10.1016/j.jenvman.2016.12.014
- European Commission. (2016). *The European Tourism Indicator System: ETIS toolkit for sustainable destination management*. Retrieved from <http://ec.europa.eu/DocsRoom/documents/21749/attachments/1/translations/en/renditions/pdf>
- European Commission. (2007). *Analysis of national sets of indicators used in the National Reform Programmes and Sustainable Development Strategies*. Retrieved from <https://ec.europa.eu/eurostat/documents/3888793/5844237/KS-RA-07-028-EN.PDF/d10749ca-fa4d-471c-b9c6-3c9dfc7d92bf?version=1.0>
- Fernández, J. I. P., & Rivero, M. S. (2009). Measuring tourism sustainability: proposal for a composite index. *Tourism Economics*, 15(2), 277-296. doi: 10.5367/000000009788254377

- Gahin, R., Veleva, V., & Hart, M. (2003). Do indicators help create sustainable communities? *Local environment*, 8(6), 661-666. doi: 10.1080/1354983032000152752
- General Assembly of United Nations. (2015). *United Nations Summit on Sustainable Development 2015: Informal summary*. Retrieved from <https://sustainabledevelopment.un.org/content/documents/8521Informal%20Summary%20-%20UN%20Summit%20on%20Sustainable%20Development%202015.pdf>
- Hezri, A. A., & Dovers, S. R. (2006). Sustainability indicators, policy and governance: Issues for ecological economics. *Ecological Economics*, 60(1), 86-99. doi: 10.1016/j.ecolecon.2005.11.019
- Holden, A. (2003). In need of new environmental ethics for tourism? *Annals of Tourism Research*, 30(1), 94-108. doi: 10.1016/S0160-7383(02)00030-0
- Holden, A. (2016). *Environment and tourism*. New York: Routledge.
- Holloway, J. C., & Taylor, N. (2006). *The business of tourism*. London: Pearson.
- Hughes, P. (1994). *La planificación del turismo sostenible. El proyecto Ecomost*. Lewes: Federacion Internacional de Tour Operadores.
- Hunter, C. J. (1995). On the need to re-conceptualise sustainable tourism development. *Journal of Sustainable Tourism*, 3(3), 155-165. doi: 10.1080/09669589509510720
- Kline, P. (2013). *Handbook of psychological testing*. New York: Routledge.
- Ko, T. G. (2005). Development of a tourism sustainability assessment procedure: a conceptual approach. *Tourism Management*, 26(3), 431-445. doi: 10.1016/j.tourman.2003.12.003
- Iacobucci, D. (2010). Structural equations modeling: Fit indices, sample size, and advanced topics. *Journal of Consumer Psychology*, 20(1), 90-98. doi: 10.1016/j.jcps.2009.09.003
- Lee, T. H., & Hsieh, H. P. (2016). Indicators of sustainable tourism: A case study from a Taiwan's wetland. *Ecological Indicators*, 67, 779-787. doi: 10.1016/j.ecolind.2016.03.023
- Liu, Z. (2003). Sustainable tourism development: A critique. *Journal of Sustainable Tourism*, 11(6), 459-475. doi: 10.1080/09669580308667216
- Mahdavi, D., Parishan, M., & Hasar, A. Y. (2013). Practical model for measuring progress towards sustainable rural tourism development (SRTD) in rural area of Iran. *International Research Journal of Applied and Basic Sciences*, 5(8), 1073-1082. Retrieved from [http://irjabs.com/files\\_site/paperlist/r\\_1558\\_130928150057.pdf](http://irjabs.com/files_site/paperlist/r_1558_130928150057.pdf)
- OECD. (2010). *International Workshop on Sustainable Development Strategies and Tourism*. Retrieved from <http://www.oecd.org/cfe/tourism/workshoponsustainabledevelopmentstrategiesandtourism.htm>
- Paramati, S. R., Shahbaz, M., & Alam, M. S. (2017). Does tourism degrade environmental quality? A comparative study of Eastern and Western European Union. *Transportation Research Part D: Transport and Environment*, 50, 1-13. doi: 10.1016/j.trd.2016.10.034
- Patterson, C. (2016). *Sustainable tourism: Business development, operations, and Management*. Champaign: Human Kinetics.
- Rebollo, J. F. V., & Baidal, J. A. I. (2003). Measuring sustainability in a mass tourist destination: pressures, perceptions and policy responses in Torrevieja, Spain. *Journal of Sustainable Tourism*, 11(2-3), 181-203. doi: 10.1080/09669580308667202

- Reihanian, A., Hin, T. W., Kahrom, E., & Binti Mahmood, N. Z. (2015). A framework for implementing sustainable tourism in national parks of Iran: development and use of sustainable tourism indicators in Boujagh National Park, Iran. *Caspian Journal of Environmental Sciences*, 13(1), 41-52. Retrieved from [http://cjes.guilan.ac.ir/article\\_202\\_32.html](http://cjes.guilan.ac.ir/article_202_32.html)
- Roberts, S., & Tribe, J. (2008). Sustainability indicators for small tourism enterprises: An exploratory perspective. *Journal of Sustainable Tourism*, 16(5), 575-594. doi: 10.1080/09669580802159644
- Robinson, P., Luck, M., & Smith, S. L. J. (2013). *Tourism*. Wallingford: CAB International.
- Romolini, A., Fissi, S., & Gori, E. (2017). Integrating territory regeneration, culture and sustainable tourism. The Italian albergo diffuso model of hospitality. *Tourism Management Perspectives*, 22, 67-72. doi: 10.1016/j.tmp.2017.02.002
- Sanchez, M., & Pulido, J. I. (2008). *Medida de la sostenibilidad turistica. Propuesta de un indice sintetico*. Madrid: Editorial Universitaria Ramon Areces.
- Schianetz, K., & Kavanagh, L. (2008). Sustainability indicators for tourism destinations: A complex adaptive systems approach using systemic indicator systems. *Journal of Sustainable Tourism*, 16(6), 601-628. doi: 10.1080/09669580802159651
- Sedai, R. C. (2006). *Assessing the sustainability of tourism in rural areas: A case study of Tamang Heritage Trail, Rasuwa*. Biratnagar, Nepal: Purbanchal University.
- Sharpley, R. (2009). *Tourism development and the environment: Beyond sustainability?* New York: Routledge.
- Smeets, E., & Weterings, R. (1999). *Environmental indicators: Typology and overview*. Retrieved from <https://www.eea.europa.eu/publications/TEC25>
- Sors, J. C. (2001). Measuring progress towards sustainable development in Venice: a comparative assessment of methods and approaches. *FEEM Working Paper No. 16*. doi: 10.2139/ssrn.275133
- Torres-Delgado, A., & Saarinen, J. (2014). Using indicators to assess sustainable tourism development: a review. *Tourism Geographies*, 16(1), 31-47. doi: 10.1080/14616688.2013.867530
- Tsaur, S. H., & Wang, C. H. (2007). The evaluation of sustainable tourism development by analytic hierarchy process and fuzzy set theory: An empirical study on the Green Island in Taiwan. *Asia Pacific Journal of Tourism Research*, 12(2), 127-145. doi: 10.1080/10941660701243356
- Tučková, Z., & Jurigová, Z. (2014). *The meaning of tourism and tourism services in the V4 countries*. Zilina: GEORG.
- Valentin, A., & Spangenberg, J. H. (2000). A guide to community sustainability indicators. *Environmental Impact Assessment Review*, 20(3), 381-392. doi: 10.1016/S0195-9255(00)00049-4
- Vila, M., Costa, G., & Rovira, X. (2010). The creation and use of scorecards in tourism planning: A Spanish example. *Tourism Management*, 31(2), 232-239. doi: 10.1016/j.tourman.2009.02.015
- Weaver, D., & Lawton, L. (1999). *Sustainable tourism: A critical analysis*. Gold Coast: CRC.



- Wheeller, B. (1993). Sustaining the ego. *Journal of Sustainable Tourism*, 1(2), 121-129. doi: 10.1080/09669589309450710
- WTO. (2018). *UNWTO Tourism Highlights 2018 Edition*. Retrieved from <https://www.e-unwto.org/doi/pdf/10.18111/9789284419876>
- WTO. (2004). *Indicators of sustainable development for tourism destinations: A guidebook*. Madrid: WTO.
- WTO. (1995). *What tourism managers need to know: A practical guide to the development and use of indicators of sustainable tourism*. Madrid: WTO.
- World Travel & Tourism Council. (2019). *Economic Impact 2019*. Retrieved from <https://www.wttc.org/-/media/files/reports/economic-impact-research/regions-2019/world2019.pdf>
- Ziaabadi, M., Malakootian, M., Mehrjerdi, M. R. Z., Jalaei, S. A., & Boshraabadi, H. M. (2017). How to use composite indicator and linear programming model for determine sustainable tourism. *Journal of Environmental Health Science and Engineering*, 15(1), article 9. doi: 10.1186/s40201-017-0271-5

#### Contact information

##### **Mohsin Javed**

Tomas Bata University in Zlín, Faculty of Management and Economics  
Mostní 5139, 76001, Zlín, Czech Republic  
E-mail: [javed@utb.cz](mailto:javed@utb.cz)  
ORCID: 0000-0002-3061-8210

##### **doc. Ing. Zuzana Tučková, Ph.D.**

Tomas Bata University in Zlín, Faculty of Management and Economics  
Mostní 5139, 76001, Zlín, Czech Republic  
E-mail: [tuckova@utb.cz](mailto:tuckova@utb.cz)  
ORCID: 0000-0001-7443-7078

doi: 10.7441/dokbat.2019.046

# **‘SHOULD I PURCHASE OR NOT’? A LITERATURE REVIEW OF COUNTRY-OF-ORIGIN EFFECT ON THE USE OF DOMESTIC BRAND**

*Abdul Bashiru Jibril, Michael Adu Kwarteng, Miloslava Chovancová, Richard Denanyoh, Victor Kwarteng Owusu, Hoang Hung Cuong*

## **Abstract**

Customer’s product identification with respect to country-of-design (COD), country-of-manufacturer (COM), and country-of-assembly (COA) has become a driver or a communication tool regarding customers’ purchase intention and use of a product. This article, (1) reviews the literature in relation to the effect of country-of-origin (COO) on buyer’s evaluation of domestic products or brands, and (2) Proposed a conceptual model depicting the trajectory through which COO impact on consumer purchase intention towards a domestic product/brand. The current study implores a qualitative inquiry with a specific focus on document analysis as well as experts’ opinions. From the literature, it has emerged that country-of-origin effect (notably, COD, COM, and COA) plays a significant role in determining consumer’s buying decisions towards both domestic and foreign products. Additionally, it was discovered that country-of-manufacture determines a product/ brand evaluation (in terms of quality) relatively to COD and COA. Practically, the study is important for countries (especially resource-poor and developing countries) that need to increase manufactured exports and for firms that sourced/import products in countries different from where they are sold. Theoretically, it widens the concept of brand management with the interplay of COO effect on consumer purchase intention. Marketing inferences are drawn, and direction for future research is developed in the entire manuscript.

*Keywords: Country-of-origin, Customer product identification, Consumer purchase intention, Domestic brand*

## **1 INTRODUCTION**

Globalization has made it possible for manufacturers and marketers or even service-related agents to have their product/brand available all over the world. While the complex nature of human behaviour has informed manufacturers and product/brand designers to build a stronger brand image with all the strategic marketing tools needed to lure the minds of customers (Kotler & Gertner, 2002). In light of this, the growing availability of foreign goods in most domestic markets has discovered in the literature (Cowan & Guzman, 2018; Xie, Chen, Zhang, & Cui, 2018) to have had a growing impact on local production. Henceforth, the country-of-origin (COO) cue has become imperative for scholars and practitioners to debate on the customer-centric approach of making a decision on an imported good in a different dimension relative to domestic brands before purchasing.

Bhakar, Bhakar, and Bhakar, (2013) gave their definition of COO effects as ‘any influence that the country of the manufacturer has on consumer’s positive or negative perception of a product’. While (Kotler & Gertner, 2002; Kotler & Keller, 1988) opined that, a brand is a name, term, design, symbol or any other feature that identifies one seller's good or service as distinct from those of other sellers (competitors). Though, ‘brand’ as used in the context of business, marketing, and advertising, also sometimes distinguished from generic or store brands. However, a historical antecedence of country image dates back to 1970, an academic paper is

written by Nagashima, (1970), defined country image as a special image, stereotype and standing, which customers have in their mind about specific country, and this picture can be shaped by historical, economical and traditional variables (Kumar, Lee, & Kim, 2009). In addition, country image is one of the initial construct antecedents that scholars consider for foreign products and the interplay of international business and consumer behaviour studies (Lee & Kotler, 2011). Research issues concerning country image have been prominent in international business for many years. For example, according to Kotler & Gertner, (2002) customers' perception regarding the impact of COO on consumer purchase intention is a particular theme in marketing research.

In light of this, research into consumer behaviour and brand management has intensified the competition among businesses (both local and foreign) in a country as more domestic brands struggle to gain market share. Therefore, the fear of a backlash of foreign brands among multinationals has led corporate institutions to search for new strategies for continuous growth. Inasmuch the concept of domestic brand in the present study is concern, it is important to understand that the term domestic brand could interpreted to mean manufacturer owned brands which are generally companies with substantial resources within a local or national economy. Therefore, it is important to evaluate the controversy concerning the significance of COO in the consumer decision-making process towards the consumption of domestic products/brands (Rezvani et al., 2012; Suter, Borini, Floriani, da Silva, & Polo, 2018)). Against this bedrock, the current research aims at uncovering the menace of country-of-origin image through (1) a literature review in relation to the effect of country-of-origin (COO) on buyer evaluations of domestic products or brands, and (2) Proposed a conceptual model depicting the trajectory through which COO impact on consumer purchase intention towards a domestic brand. As a matter of fact, the results of this research contribute to the theoretical debate concerning the importance of COO in the decision-making process of a consumer. It adds deeper insight into the interplay of combined domestic and foreign brands in the global market. Practically, the study is important for countries (especially resource-poor, developing countries) that need to increase manufactured exports as well as providing marketing strategy for firms that obtained their products in countries different from where they are sold. Notwithstanding, this article would highlight the benefit of brand management to practitioners in the heat of competition regarding business growth and sustenance.

The structure of the paper is as follows: firstly, it begins with a review of the essential prior studies of the country-of-origin effect on a domestic product purchase intention and makes a recap on the interaction of brand concept in the market. The latter part of the research presents the approach and the method used and proceeded to the development of a conceptual framework and research hypothesis. Finally, implication for theory and practice, conclusion and future research directions are presented.

## **2 PRIOR STUDIES ON COUNTRY-OF-ORIGIN EFFECT AND DEFINITION OF CONCEPT**

Country image or country-of-origin effect studies have become a significant and popular area of international business research for decades. In spite of such interest developed by previous researchers, a review of the relevant literature provides contrasting and often confusing views relating to how country-of-origin image is clearly defined. However, past scholars working on the concept regarding the impact of COO considered two broad complementary directions, notably product-country image and evaluation of product quality. These studies took into consideration an interest or motivation through which consumers examine the COO cues in determining product quality. Though consumers have stereotypes about the image of a country

that affect interest and willingness to buy (Karoui & Khemakhem, 2019). For example, in America during the 1960s “Made in Japan” meant “poor quality” and this is described as the stereotypic notion of such citizens. Also, ethnocentrically, national pride of people regarding the potential targeted country about the country-of-origin can impact purchase behaviour from medium-to-long-term business transactions. It worth to know that several studies have revealed that COO has become a significant phenomenon in consumer behaviour studies (Brodie, Glynn, & Van Durme, 2002; Chovancová & Asamoah, 2013; Chovancová, Osakwe, & Ogbonna, 2015). Hence, this has increased the knowledge of customers about product selection and evaluation regarding product/brand origin.

## **2.1 Consumers’ product identification**

### *Country-of-design (COD)*

The concept of COD described the country in which architectural works of a new/particular product are done before it comes to fruition via manufacturing. From the viewpoint of customers, it is noted that the country’s image influences existing product evaluations, and ultimately could be transferred to new products associated with the same country (Ghali-Zinoubi & Toukabri, 2019). This transfer occurs because of the perceived similarity between product’s levels of associated with the country and regarding a new product in question. Meanwhile, a study has demonstrated the moderating effect of perceived similarity between known and new products on the relationship between product-specific country image and new product evaluation (Schätzle, & Jacob, 2017). However, that study indicated the notion and significance of country image for a specific product category either local or global country image, which might explain the role of product similarity. Notwithstanding, other conceptualizations of the perceptual distance between a country and a product include the “match” between country image and product. Hence COD suggests the importance of the perceived consistency between the product and the country image, even though they do not measure the durability or quality of the product directly.

On this note, we could ascertain that consumers’ perceptions of overall country images vary substantially in terms of the magnitude of associations they make towards buying decision-making process. However, in many instances, customers hold strong associations/perceptions in memory when thinking about countries (e.g. high-technology and highly skilled labour in the UK, fashion and good taste for France, design for Italy, cheap for China, among others). These strong country associations/perceptions may get activated when consumers know or are informed that a given product (or brand) has been designed or manufactured in a given country (Clifton, 2009; Rezvani et al., 2012; Xie, Chen, Zhang, & Cui, 2018). By analogy with regards to the concept of brand extensions, which can benefit from a positive, strong brand image, a country image may be transferable to products according to the logical connection or perceptual distance between the country image and the product. Therefore, we propose in the current study that;

H1: Country-of-origin design positively related to consumer purchase intention of a domestic product.

### *Country-of-manufacture (COM)*

The concept refers to the country-of-origin regarding the geographical location in which a product/brand is made. A study by Hamzaoui and Merunka, (2006) examined that a country’s image, both COD and COM are an important determinant of product evaluation in terms of product category. From their research, it was deduced that consumers from emerging

economies are more inclined (sensitive) to COD towards product/brand with status-symbolic meanings (such as automobiles and television sets). However, in the contemporary context of market globalization and competition among business organizations, COD and COM have become a psychological antecedent that stimulates consumers' decision making toward intention to purchase a particular product/brand domestically. Consequently, the perceived or actual country image from customers' viewpoint can provide businesses (local or international) with competitive advantage and indicate an important concept in the consumer behavior theory (Kotler & Gertner, 2002; Schätzle, & Jacob, 2017)). For example, a product/brand manufactured in its COD (say, France) and compared within a country with lower manufacturing costs (say, Romania), such product could be evaluated and perceived differently by a customer. Again, studies have suggested that consumers from developed countries might not trust the capacity and the ability of an emerging economy to offer a quality product /brand conceived in a developed world. For instance, Toyota cars manufactured in Japan, and consumers from developing countries might not consider a well-known brand like 'Mercedes Benz' from a developed country (Germany) that has been manufactured in a developing country like Ghana, since the notion towards developing country would suffer to provide sufficient status and prestige (Krake, 2005; Wu, Ju, & Doodoo, 2016). On this note, we, therefore, proposed;

H2: Country-of-manufacture positively related to consumer purchase intention of a domestic product.

#### *Country-of-assembly (COA)*

COA refers to the country where the mainstream of the final assembly of the product takes place while COD and COM indicate the locations where the product is designed and manufactured respectively. The country harbours the assembly plant and other accompanying equipment and technologies needed to undertake the next stage of the production process (Thøgersen, Pedersen, & Aschemann-Witzel, 2019). The COA cue affects consumers' product evaluations and purchases intentions in different ways. With regard to ongoing globalization, it noted that several business organizations (mainly multinational firms) have shifted their assembly lines to other countries, such as China, Indonesia, Vietnam, among others not only to achieve foreign direct investment (FDI) but to benefit from the low-cost production. COA thus becomes increasingly important when considering the COO effect towards consumers' product evaluations on products' functionality and recognisability.

According to Wu, Ju, & Doodoo (2016), COA affects purchase intention with consumers' cognitive information processing. Therefore, when consumers evaluate useful (or effective) products, information of COA is been taken into account as a cue to perceive the quality of the product. Moreover, under the Theory of Cognitive Dissonance (Festinger, 1962), he opined that, if the COA information is consistent with consumers' existing cognitions (thoughts), consumers tend to have a higher purchase intention and a favorable product evaluation. For example, in the automobile industry, young generations are aware of the utility and functional features of the products (Heine, Atwal, & He, 2019). Therefore, marketing and advertising information of brands like BMW, Toyota, and Honda, etc., have the majority of their assembly processes conducted in developing countries in the Asian enclave, so as to gain cost advantage (Wu et al., 2016). In view of this, our present study also considers COA as a composite function of COO effect specifically consumers' product evaluations and purchase intentions towards a domestic product/brand. Hence, we proposed that;

H3: Country-of-assembly positively related to consumer purchase intention of a domestic product.

### *Purchase intention vs use of the domestic product*

The term ‘intention’ in this article is used to describe a person's commitment, plan, or decision to carry out an action or achieve a specific goal. It typically transforms reasons for acting (e.g., attitudes, subjective norms, or motives or desires to act) into action and in fact has been used synonymously at times with choice, decision, and plan (Ajzen, 1991; Eagly & Chaiken, 1993). By extension, purchase intention to some scholars could mean the likelihood of a customer buying the same product again based on his/her purchase history. Similarly, it refers to the need for a product that is driving the customer towards a purchase (Ghali-Zinoubi & Toukabri, 2019). Henceforth, when a customer is intent to buy a product, and he/she is, therefore, a prime potential.

Meanwhile, the influence of country image on the intention to purchase however is primarily controlled through consumers’ perceptions of the attributes of a particular product/brand. By virtue of this notion, research has established that there is a relationship between cognitive country image, product image, and purchase intention. Cognitive image as suggested by Eagly and Chaiken, (1993) is perceived to influence product image associated with a country (e.g., durable, well designed, workmanship, etc.). The cognitive image (reasoning) is connected with the affective destination image of individuals' feelings toward a destination or as an emotional response of individuals to a place. This consequently, acts as an important cue that influences perceived product quality, leading to purchase intention. In other words, while cognitive country image leads to purchase intention, which subsequently influence use of domestic product/brand purchase intention. Hence, we, therefore, posit that purchase intention (such as decision, desire, plan, attitude, etc.) mediate COD, COM, and COA towards used of domestic product/brand.

H4: Country-of-design strongly predicts the use of domestic products via the mediation of consumer purchase intention.

H5: Country-of-manufacture strongly predicts the use of domestic products via the mediation of consumer purchase intention.

H6: Country-of-assembly strongly predicts the use of domestic products via the mediation of consumer purchase intention.

### **3 CONCEPTUAL MODEL DEVELOPMENT AND RESEARCH HYPOTHESES**

As discussed in the literature review, there is a need to propose a conceptual model that be interpreted as the most salient aspect of the user’s perspective. Therefore, it worth to know that different theoretical foundations have been analyzed to suit the current study, such as Theory of Cognitive Dissonance (TCD) proposed by (Festinger, 1962), and the Theory of Planned Behavior (TPB) introduced by Ajzen (1991).

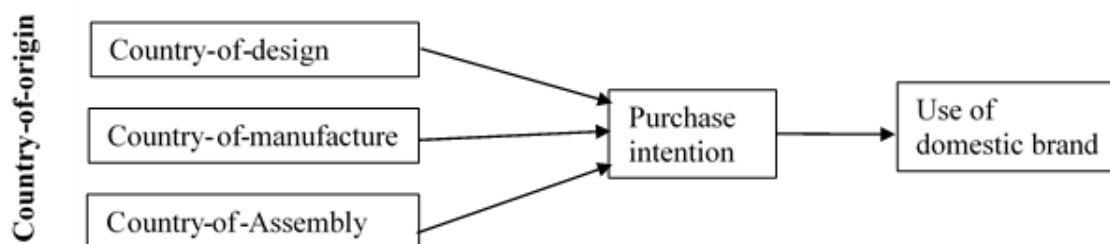

Fig. 1 – Conceptual model. Source: Festinger (1962), Ajzen (1991), Hamzaoui & Merunka (2006)

Tab. 1 – Synopsis of hypotheses. Source: own research

H#	Independent variable	Dependent variable	Hypotheses
H1	Country-of-design	Consumer purchase intention	Country-of-design strongly predict consumer's purchase intention toward the use of the domestic brand
H2	Country-of-manufacture	Consumer purchase intention	Country-of-manufacture strongly predict consumer's purchase intention toward the use of the domestic brand
H3	Country-of-Assemble	Consumer purchase intention	Country-of-Assembly strongly predict consumer's purchase intention toward the use of the domestic brand
H4	Consumer purchase intention	Use of domestic brand	Country-of-design strongly predict the use of domestic brand via the mediation of consumer purchase intention
H5	Consumer purchase intention	Use of domestic brand	Country-of-manufacture strongly predict the use of domestic brand via the mediation of consumer purchase intention
H6	Consumer purchase intention	Use of domestic brand	Country-of-assembly strongly predict the use of domestic brand via the mediation of consumer purchase intention

## 4 METHODOLOGY

This study uses a thorough analysis of extant literature mainly centred on the theme under study. A systematic inquiry of past papers (journal and conference proceedings) and books (book chapters) which are mostly indexed in a reputable database such as WoS, Scopus, EBSCO, Google scholar, etc. were employed to track contemporary works so as to execute the goal of the present study. The rationale behind this selected technique (document and content analysis) is to gauge the above-mentioned variables; thus COD, COM, and COA in terms of how these constructs were applied and interpreted in the previous studies. Moreover, the approach is also polarized from the perceptive of previous researchers regarding the consistencies and discrepancies that have been emerged in the literature.

Therefore, this procedure gives the writers the due advantage of searching for relations and patterns across a variety of related articles by taking into consideration the current study focus. Again, the method gives a spectacular lens and a broader perspective of the topic and therefore, we deemed it reasonable to adopt a document and content analysis as our methodology in this case since it provides a variety of study contexts in this situation. In the nutshell, through document analysis, imperative content could be simplified in relation to the present theme in order to attain the proposed objective of our study.

However, a quantitative research inquiry will be deployed to execute the current study. This is because the current research model was based on concrete evidence on the reviewed literature, therefore the nature of the current study is to test the model so as to build a theory afterward. Also, in other to validate the current research hypotheses, it is imperative to capture adequate statistical evidence from a target population.

## 5 CONCLUSION

The current research aims at uncovering the menace of country-of-origin image through (1) a literature review in relation to the effect of country-of-origin (COO) on buyer evaluations of domestic products or brands, and (2) Proposed a conceptual model depicting the trajectory through which COO impact on consumer purchase intention towards a domestic brand. For the betterment of readers as well as users understand this epistle, we decomposed and simplified the COO image in the literature into three dimensions, notably, COD, COM, and COA. The rationale behind this goal stemmed from the combined effect of the proliferation of foreign and domestic products/brands in the global market. Again, consumers in developed and developing countries primarily have different perceptions of product quality (Roth & Romeo, 1992).

### 5.1 Theoretical relevance

This theme under investigation has received considerable attention from both practitioners and scholars' inasmuch the influence of domestic and foreign product consumption is concerned. Therefore, this study tries to reveal more insight and add to the literature by discovering the major dimensions of COO (COD, COM, and COA) that impacts on consumers or influence their purchase intention towards a particular product/brand origin. Notwithstanding, the current article is valuable for promoting consumer behaviour literature by establishing the connection or relationship between the aforementioned dimensions and the purchase intention (Rezvani et al., 2012). Additionally, the existing literature indicated that all the dimensions studied in this paper justify the relationship or the antecedent regarding COO effects on purchase intention from consumer point of view (Kim & Chung, 1997). Also, researchers in this field would benefit from the revision of this article in terms of retesting the proposed model for empirical support. Consequently, the study broadens the horizon of the concept of consumer behaviour and brand management regarding the implication towards product/brand sustainability and growth.

### 5.2 Managerial relevance

Practically, the country image represents three constructs (COD, COM, and COA) from this review, hence, practitioners are advised not to focus purely on promoting their own company's corporate and product image, since there is also a need to consider country image (Pappu, Quester, & Cooksey, 2007). Therefore, business organizations with products that are favourably perceived by consumers and are associated with an average or inferior country image should position themselves on their product image by re-strategize their country image for a competitive advantage. This reflects strongly on our findings that product image regarding COO in itself has a strong influence on product/brand choice and purchase intention from the customer's viewpoint. On the other hand, when a firm is associated with a particular nation (developed country) that has a positive country image, has a tendency or positive response of purchase intention and subsequent a use of product/brand domestically (Paswan, Kulkarni, & Ganesh, 2003). The paper suggests usefulness of COO knowledge for especially SME's development and growth, bearing in mind consumers tend to use country image as a cue to infer product quality when they lack a clear product image in their minds (Kim & Chung, 1997).

In addition, the present inquiry offers strategies for International marketers to take into account the significant role of COO effects on both local on foreign products/brands. This is important discovery would argument the existing determining factors of consumer inclination toward product/brand origin. Nonetheless, multinational firms (International strategic alliances), as well as globally developed hybrid products could, therefore, provide an alternative route to reshape any anticipated negative attitude that may arise from consumers' decisions with regards to domestic or foreign product/brand. Meanwhile, the current study would interest brand



managers to know that firms to consider such factors when looking to develop their international operations. While a country image building process is largely beyond the control of most organizations, it is important for decision-makers, as well as policymakers, to comprehend the magnitude of COO impact in order to enhance the competitiveness in both national and international market settings (Pappu, Quester, & Cooksey, 2005; Pappu et al., 2007). Finally, the study is important for countries (especially resource-poor and developing countries) that need to increase manufactured exports and for firms that sourced/import products in countries different from where they are sold.

### 5.3 Limitation for future research direction

In spite of the knowledge discovered in this review, the study is still faced with some limitations. Firstly, the research model proposed lacks empirical evidence to test the validity and reliability of the model constructs. Secondly, inasmuch as the study primarily considers the extrinsic cues of the COO image, the intrinsic value of the product/brand has not been considered in the present study. Thirdly, there are many factors that have not been considered as a determinant of consumer purchase intention with regards to country-of-origin issues.

Therefore, it would be interesting if future scholars could consider and an empirical study (thus, quantitative and/or qualitative inquiry) in order to juxtapose the proposed model in question. Similarly, new researchers could take advantage of this review as a base to discover other dimensions (constructs) related to the country-of-origin image that informs consumer purchase intention.

### Acknowledgment

This work was supported by the Internal Grant Agency of FaME through TBU in Zlín No. IGA/FaME/2019/008; Project title: Country-of-origin effect on the domestic product (brand) purchasing intention and SME's sustainability in developing countries.

### References

- Ajzen, I. (1991). The theory of planned behavior. *Organizational behavior and human decision processes*, 50(2), 179-211. doi: 10.1016/0749-5978(91)90020-T
- Bhakar, S. S., Bhakar, S., & Bhakar, S. (2013). Relationship between country of origin, brand image, and customer purchase intentions. *Far East Journal of Psychology and Business*, 10(4), 25-47. Retrieved from <https://ideas.repec.org/a/fej/article/v10by2013i4p25-47.html>
- Brodie, R. J., Glynn, M. S., & Van Durme, J. (2002). Towards a theory of marketplace equity: integrating branding and relationship thinking with financial thinking. *Marketing Theory*, 2(1), 5-28. doi: 10.1177/147059310200200101
- Chovancová, M., & Asamoah, E. S. (2013). *Consumer Behaviour and Branding: Perspectives from the Fast Food Industry in Different Markets*. Žilina, Slovakia: GEORG.
- Chovancová, M., Osakwe, C. N., & Ogbonna, B. U. (2015). Building strong customer relationships through brand orientation in small service firms: An empirical investigation. *Croatian Economic Survey*, 17(1), 111-138. doi: 10.15179/ces.17.1.4
- Clifton, R. (2009). *Brands and branding*. New York: John Wiley & Sons.

- Cowan, K., & Guzman, F. (2018). How CSR reputation, sustainability signals, and country-of-origin sustainability reputation contribute to corporate brand performance: An exploratory study. *Journal of Business Research*. doi: 10.1016/j.jbusres.2018.11.017
- Eagly, A. H., & Chaiken, S. (1993). *The psychology of attitudes*. Harcourt Brace Jovanovich College Publishers. American Psychological Association.
- Festinger, L. (1962). *A theory of cognitive dissonance*. Stanford: Stanford university press.
- Ghali-Zinoubi, Z., & Toukabri, M. (2019). The antecedents of the consumer purchase intention: Sensitivity to price and involvement in the organic product: Moderating role of product regional identity. *Trends in Food Science & Technology*, 90(1), 175-179. doi: 10.1016/j.tifs.2019.02.028
- Hamzaoui, L., & Merunka, D. (2006). The impact of country of design and country of manufacture on consumer perceptions of bi-national products' quality: an empirical model based on the concept of fit. *Journal of Consumer Marketing*, 23(3), 145-155. doi: 10.1108/07363760610663303
- Heine, K., Atwal, G., & He, J. (2019). Managing country-of-origin affiliations for luxury brand-building in China. *Australasian Marketing Journal (AMJ)*, 27(1), 14-23. doi: 10.1016/j.ausmj.2018.09.001
- Karoui, S., & Khemakhem, R. (2019). Consumer ethnocentrism in developing countries. *European Research on Management and Business Economics*, 25(2), 63-71. doi: 10.1016/j.iedeen.2019.04.002
- Kim, C. K., & Chung, J. Y. (1997). Brand popularity, country image, and market share: an empirical study. *Journal of International Business Studies*, 28(2), 361-386. doi: 10.1057/palgrave.jibs.8490105
- Kotler, P., & Gertner, D. (2002). A country as a brand, product, and beyond: A place marketing and brand management perspective. *Journal of Brand Management*, 9(4), 249-261. doi: 10.1057/palgrave.bm.2540076
- Kotler, P., & Keller, K. L. (1988). *Marketing Management*. New Jersey: Pearson.
- Krake, F. B. (2005). Successful brand management in SMEs: a new theory and practical hints. *Journal of Product & Brand Management*, 14(4), 228-238. doi: 10.1108/10610420510609230
- Kumar, A., Lee, H.-J., & Kim, Y.-K. (2009). Indian consumers' purchase intention toward the United States versus the local brand. *Journal of Business Research*, 62(5), 521-527. doi: 10.1016/j.jbusres.2008.06.018
- Lee, N. R., & Kotler, P. (2011). *Social marketing: Influencing behaviors for good*. London: Sage Publications.
- Nagashima, A. (1970). A comparison of Japanese and US attitudes toward foreign products. *Journal of Marketing*, 34(1), 68-74. doi: 10.1177/002224297003400115
- Pappu, R., Quester, P. G., & Cooksey, R. W. (2005). Consumer-based brand equity: improving the measurement—empirical evidence. *Journal of Product & Brand Management*, 14(3), 143-154. doi: 10.1108/10610420510601012
- Pappu, R., Quester, P. G., & Cooksey, R. W. (2007). Country image and consumer-based brand equity: relationships and implications for international marketing. *Journal of International Business Studies*, 38(5), 726-745. doi: 10.1057/palgrave.jibs.8400293

- Paswan, A. K., Kulkarni, S., & Ganesh, G. (2003). Loyalty towards the country, the state, and the service brands. *Journal of Brand Management*, 10(3), 233-251. doi: 10.1057/palgrave.bm.2540119
- Rezvani, S., Dehkordi, G. J., Rahman, M. S., Fouladivanda, F., Habibi, M., & Eghtebasi, S. (2012). A conceptual study on the country of origin effect on consumer purchase intention. *Asian Social Science*, 8(12), 205-215. doi: 10.5539/ass.v8n12p205
- Roth, M. S., & Romeo, J. B. (1992). Matching product category and country image perceptions: A framework for managing country-of-origin effects. *Journal of International Business Studies*, 23(3), 477-497. doi: 10.1057/palgrave.jibs.8490276
- Schätzle, S., & Jacob, F. (2017). Stereotypical supplier evaluation criteria as inferred from country-of-origin information. *Industrial Marketing Management*, 78(1), 250-262. doi: 10.1016/j.indmarman.2017.06.014
- Suter, M. B., Borini, F. M., Floriani, D. E., da Silva, D., & Polo, E. (2018). Country-of-origin image (COI) as a country-specific advantage (CSA): Scale development and validation of COI as a resource within the firm perspective. *Journal of Business Research*, 84(1), 46-58. doi: 10.1016/j.jbusres.2017.11.006
- Thøgersen, J., Pedersen, S., & Aschemann-Witzel, J. (2019). The impact of organic certification and country of origin on consumer food choice in developed and emerging economies. *Food Quality and Preference*, 72(1), 10-30. doi: 10.1016/j.foodqual.2018.09.003
- Wu, L., Ju, I., & Dodoo, N. A. (2016). Understanding the impact of a matchup between country-of-origin facets and country stereotypes on advertising effectiveness. *Journal of Global Marketing*, 29(4), 203-217. doi: 10.1080/08911762.2016.1185561
- Xie, Y., Chen, M., Zhang, W., & Cui, F. (2018). Neural correlates of country-of-origin image stereotype. *Neuroscience letters*, 687, 164-168. doi: 10.1016/j.neulet.2018.09.045

## Contact information

### **Abdul Bashiru Jibril**

Tomas Bata University in Zlín, Faculty of Management and Economics  
Mostní 5139, 76001, Zlín, Czech Republic  
E-mail: jibril@utb.cz  
ORCID: 0000-0003-4554-0150

### **Ing. Michael Adu Kwarteng, Ph.D.**

Tomas Bata University in Zlín, Faculty of Management and Economics  
Mostní 5139, 76001, Zlín, Czech Republic  
E-mail: kwarteng@utb.cz  
ORCID: 0000-0002-6787-0401

### **doc. Ing. Miloslava Chovancová, CSc.**

Tomas Bata University in Zlín, Faculty of Management and Economics  
Mostní 5139, 76001, Zlín, Czech Republic  
E-mail: chovancova@utb.cz  
ORCID: 0000-0002-9244-9563

**Richard Denanyoh**

Sunyani Technical University, Faculty of Business and Management  
P.O. Box 206, Sunyani, Ghana  
E-mail: richarddenanyoh@yahoo.com  
ORCID: 0000-0002-6337-9092

**Victor Kwarteng Owusu**

Tomas Bata University in Zlín, Faculty of Management and Economics  
Mostní 5139, 76001, Zlín, Czech Republic  
E-mail: owusu@utb.cz  
ORCID: 0000-0003-0520-3643

**Hung Cuong Hoang**

Tomas Bata University in Zlín, Faculty of Management and Economics  
Mostní 5139, 76001, Zlín, Czech Republic  
E-mail: hoang@utb.cz  
ORCID: 0000-0003-0732-8319

doi: 10.7441/dokbat.2019.047

# CONSULTING AN IMPORTANT SUPPORT FOR PEOPLE WITH DISABILITIES AS ENTREPRENEURS

*Bernard Joseph-Auguste*

## **Abstract**

This paper is a part of a dissertation thesis and treats one aspect of my qualitative study people with disabilities as entrepreneurs. In Germany, an organization called Enterability helps these entrepreneurs to realize their project by offering consulting. Five narrative interviews (one expert consultant and four entrepreneurs) were held. This part of the study focuses on the circumstances of starting a business for people with disabilities, the barriers involved and the available resources. As result we can note that, even if people with disabilities need a lot of support to start their business and to overcome the barriers, they are able to realize their project if offered the necessary support in a successful way. This fact should be considered by authorities, which often are responsible for the obstacles facing disabled entrepreneurs and could thus help a minority to live independently by saving money because of saved social benefits.

*Keywords: consulting, entrepreneurship, narrative interviews, people with disabilities*

## **1 INTRODUCTION**

Consulting is a huge sector in business and has a strong link to administration because of the need to collect information in a systematic way and to be able to analyse and optimize the core processes in business. Furthermore, the significance of the development of many societies into information societies has been rising, not only because of technological developments but also because of the challenge of maintaining humans development in a world with more and more demands and less and less resources, which implies the letter must be saved, and production processes must in turn be more and more optimized. This constraint is so important that even the political systems in many countries develop more and more laws to support this dynamic, for example by supporting electromobility, especially in Germany, where the largest car producers have missed this development and are now under pressure to reduce carbon dioxide emission. These circumstances are important reasons for consulting being one of the fastest growing sectors (by up to 7%), as a German study from 2016 demonstrates (BDU, 2016).

The consulting market is nevertheless a big one, and therefore it is rather interesting to identify consulting sectors that currently aren't being served by many providers, but where in the future more of them are expected to enter the market, such as consulting for people with disabilities. The possibilities offered by different governments are fixed in laws, especially in Germany, and this is why many administrative processes are involved in obtaining aid, which is why people with disabilities have a need for consulting as consumers. In this paper we want to focus on people with disabilities as entrepreneurs (active participants in the economy). While as consumers (passive participants in the economy) people with disabilities receive support from social workers and often from legal guardians, their support in the role of entrepreneurs is a new area with a different kind of consultants.

## 2 THEORETICAL BACKGROUND

According to Kloostermann, van der Leun and Rath (1999) four categories are decisive for entrepreneurship: individual resources, collective resources, feelings and motivation, and framework conditions in the target country. In the case of the latter, there may be favourable factors or barriers. Individual resources may include qualifications, competences, and similar personal characteristics (Kloostermann, van der Leun and Rath, 1999).

Disabled entrepreneurs must take all these aspects into account as other entrepreneurs do. In this context, three theories are interesting: Schumpeter's theory, Michael E. Porter's theory of competitiveness and Friedrich List's theory of national economics.

Schumpeter and Porter emphasize the importance of innovation in their theory. In Schumpeter's classic theory, the real entrepreneur is the one who innovates. And thus, Schumpeter distinguishes between five different kinds of innovation (Schumpeter, 1987): (a) Production of a new good or of a new quality of good; (b) Establishing a new method of production; (c) Acquiring a new market; (d) Finding new sources of raw materials; and (e) Reorganization of the market position.

The higher profit as a monopolist is the benefit for the entrepreneur resulting from his innovation. The motivation of an entrepreneur is more psychological than economic. He wants to build his own empire and to be a winner; he loves to create new things. If an entrepreneur is successful, he has imitators, which, according to Schumpeter, aren't entrepreneurs. They make less profit and are driven by the satisfaction of own needs, cost benefit calculus and greed.

We can suppose that most disabled people wanting to start a business cannot be subsumed under Schumpeter's definition of an entrepreneur and are more often imitators. Literature has shown that to them, an important aspect for them to be entrepreneur is an economic one, because the chances of people with disabilities on the labour market are, despite legal protection and assistance, poor.

Porter's theory of competitiveness is more recent and accentuates the meaning of innovation for entrepreneurs, but in the frame of competitiveness especially of countries. To him, four factors are decisive (Porter, 1990): (a) Factor conditions; (b) Demand conditions; (c) Related and supporting industries; and (d) Corporate strategy, structure and rivalry.

According to Porter, these factors have a direct influence on industries and on the entire nation. Industry is the main area for competitiveness and nations must strengthen enterprises for competing in a specific industrial sector by adopting the right policies, building a favourable economic environment with appropriate institutions.

The interesting aspect of Porter's theory is the emphasis on entrepreneur need for support by their countries. In economically well-developed countries, disabled entrepreneurs can receive specific assistance. On the consulting level, our research can give advice on what consulting should be like and map out what a state and its institutions can do to increase the competitiveness of disadvantaged people in entrepreneurship, especially in Germany.

Porter's theory also links to List's theory of national economics. List pointed out the meaning of productive forces and criticized Adam Smith who thought that mental processes and social benefits weren't important to the economy. In contrast to him, List defined the latter as productive forces because they provide a frame for economic success and thus cater to the needs of professionals and entrepreneurs. List noted the importance of motivation to learn even in daily work, so that creative solutions and thus innovation would lead to success (List, 1930). Today we know that List was right and that he made an important theoretical contribution to modern economic thought.

### 3 METHODOLOGY

Entrepreneurship, especially of disabled people, has only partially been sufficiently researched. Economics are focused on groups of persons with more favourable prognoses and, as in the case of disabled people founding enterprises, they should consider psychological and sociological approaches. The social sciences, on the other hand, ignore the possibility of self-realization of disabled persons through entrepreneurship. A detailed analysis of the problems of disabled entrepreneurs is recommended. The social sciences are weak when it comes to considering the principles of economic science, assessing integration and self-realization of disabled groups through entrepreneurship. In terms of the economic sciences, being our main perspective, there is a lack of more detailed knowledge which could counter recessions with the help of entrepreneurship by disabled people. For this reason, individual cases must be used for thematic work by means of qualitative methods. The narrative interview forms the most recognized scientific method for research into a field that has so far hardly been considered.

### 4 RESULTS

The following tables show the results of the interviews with the disabled entrepreneurs.

Tab. 1 – Type of disabilities. Source: own research

Type of disability	Frequency	Percentage
Mental disability as a result of a life event	2	50.0%
Physical disability	2	50.0%
Total	4	100%

In opposite to the interviewee taking a personal budget we have a balance between the type of disabilities (mental and physical disabilities). In Germany, 7.8 Million people are disabled, that means 9.4 % of the whole population. 25% of people with disabilities are older than 64 years. (Destatis, 2018)

Tab. 2 – Income of parents. Source: own research

Income of parents	Frequency	Percentage
Mean income of parents	3	75.0%
Higher income of parents	1	25.0%
Total	4	100%

In comparison to disabled entrepreneurs with parents with lower income our interviewees have a better familiarize background with higher income than the described people with disabilities in literature. (Parish & Cloud, 2006)

Even if no interviewee could fulfil the conditions of an entrepreneur according to Schumpeter some of the listed characteristics are similar to those of letter: Strength, intuition, pursuit of ideals, organizational capacity, persuasiveness, confidence, experience in crisis, willingness to change, acting with foresight, enforcement, endurance, analytical competencies and ability to self-praise.

Tab. 3 – Characteristics of persons interviewed. Source: own research

Characteristics	Frequency	Percentage
Confidence	2	50.0%
No children	2	50.0%
Experienced in crisis	2	50.0%
Willingness to change	2	50.0%
Act with foresight	2	50.0%
Enforcement	2	50.0%
Endurance	2	50.0%
No partner	1	25.0%
Analytical competencies	1	25.0%
Ability to self-praise	1	25.0%
Wanting to be a role model	1	25.0%
Strong intuition	1	25.0%
Deficient family relationships	1	25.0%
Prison experience	1	25.0%
Parent with disability	1	25.0%
Immigrant background	1	25.0%
Pursuit of ideals	1	25.0%
Organizational capacity	1	25.0%
Willingness to invest	1	25.0%
Helpfulness	1	25.0%
Persuasiveness	1	25.0%
Divorced	1	25.0%
Security needs	1	25.0%

Tab. 4 – Income and other characteristics. Source: own research

Income and other characteristics	Frequency	Percentage
Unemployed	3	60.0%
Income up to 5000 €	1	20.0%
Income 40 € per hour	1	20.0%
Politically engaged	1	20.0%
Quit rehabilitation measure	1	20.0%
Bad student	1	20.0%
Abandoned professional education because of an event leading to disability	1	20.0%
Income 16 € per hour	1	20.0%
Income up to 2500 €	1	20.0%
Single parent with two children	1	20.0%

In 2015, people working on their own earned 2015 while employed people earned 1649 € net per month in the average. 4.192 million people were independent in Germany currently. In 2011, one in four independents earned more than 2900 €, while only one of 10 employees could earn as much. 875.000 people earned maximum 1100 € and 258.000 people earned maximum 500 €. Comparing our interviewees with these statistics, we can see that they are successful. No one can be categorized as a less successful independent earning maximum 1100 €. At least two



interviewees can be classified as very successful due to their earning more than 2900 €. One of the interviewees was a bad student and thus had a lower education. In this time, he was not yet disabled. With disability caused by an accident his professional situation became worse, because he abandoned his professional education. On the other hand, this event prevented him from turning to a criminal career after a term in prison.

Tab. 5 – Education of persons interviewed. Source: own research

Education	Frequency	Percentage
Higher education	2	50.0%
Bank clerk	1	25.0%
High school	1	25.0%
Middle school	1	25.0%
Social work	1	25.0%

Except for one interviewee, the interviewees had at least a middle-level education. Two of them had a higher education. One interviewee has two professional qualifications (social worker and bank clerk). Having these qualifications is a big advantage when establishing oneself as legal guardian. All in all, our interviewees have a higher degree of education than most people with disabilities.

“The World Health Organization and the World Bank estimate that one billion people experience some form of disability. Of those, it is estimated that 93 to 150 million are children. According to Plan International these children are 10 times less likely to go to school than other children and when they do attend school, it is likely to be in a segregated setting. The Global Partnership for Education estimates that 90% of children with disabilities in low and lower-middle income countries do not go to school.” (Ravassard, 2018)

“Similarly, considering the second definition of disability, in the EU as a whole the rate of early leavers from school and education was much higher for disabled people than for those not having a disability: 31.5 % compared with 12.3 %.” (Eurostat, 2019)

The next table shows the reasons of the interviewees having a better education than most of the disabled people. Only one of them was disabled since birth. The other interviewees were disabled during life, so that they were not yet disadvantaged as students.

Tab. 6 – Education of persons interviewed. Source: own research

Time period	Frequency	Percentage
During life	2	50.0%
In the middle of life	1	25.0%
Since birth	1	25.0%

Budget recipient as well budget takers as entrepreneurs considered clerks were barriers to their project. The difference is that the number of complaints by legal guardians (3) was much higher than by consultants (0). On the other hand, legal guardians do not depend on administrations and work with a lot of different clerks. The consultants of Enterability offer their services on behalf of the employment exchange, which is why the dependencies from this administration is more intense. They do a feasibility assessment of the business project of the entrepreneur with disability for this administration.

Tab. 7 – Barriers in the entrepreneurship. Source: own research

Barriers	Frequency	Percentage
Unequal treatment	3	60.0%
Bureaucracy as a barrier	2	40.0%
Rejection by authorities	2	40.0%
Lack of legal knowledge	2	40.0%
Limited mobility	2	40.0%
Disability as a barrier	2	40.0%
Insufficient income	1	20.0%
Classification as not being able to work	1	20.0%
Connection to a welfare association	1	20.0%
Burden of proof for the project	1	20.0%
Lack of liquidity	1	20.0%
Insufficient space	1	20.0%
Insufficient digitization	1	20.0%
No IT support	1	20.0%
Failed seminar	1	20.0%
Ignorance of existing services	1	20.0%
Difficulty in creation of a business plan	1	20.0%
Skills shortage	1	20.0%
Uncertainty and complexity	1	20.0%
Difficult to locate supporter	1	20.0%
Housing shortage	1	20.0%
Duration of creation of entrepreneurship	1	20.0%
Employment	1	20.0%
Education compulsory	1	20.0%
Clerk as a barrier	1	20.0%
Personal barrier	1	20.0%

For entrepreneurs with disability, the biggest barrier is unequal treatment (three in four interviewees experience thus as entrepreneurs). People with disabilities are not seen as entrepreneurs by authorities and they feel that because support is lacking because of this.

In this context one very important piece of advice could improve this situation. Röhl suggest, to install a single authority for all administrative processes concerning small and middle entrepreneurs (Röhl, 2016).

Tab. 8 – Reasons for entrepreneurship. Source: own research

Reasons for entrepreneurship	Frequency	Percentage
No employer available	3	60.0%
No perspective	2	40.0%
No employer with flexible working time		
Digitalization no improvement for job opportunities for people with disabilities	1	20.0%
Fixed-term employment contracts	1	20.0%
Dissatisfaction with job	1	20.0%

This table confirms the situation of people with disability described in literature. In spite of legal support, people with disabilities, cannot find an employment, which is why they use entrepreneurship as alternative to make a living in an independent way.

Tab. 9 – Problems of support measures. Source: own research

Problems of support measures	Frequency	Percentage
Under informed employers	1	20.0%
Tripling equalization fee	2	40.0%
Suing for equalization fee	1	20.0%
Strong increase of equalization fee	2	40.0%
Competitive service providers with limited funds	1	20.0%
Ineffectiveness of the quota system	1	20.0%

This table shows important reasons why the support offered to people with disabilities in Germany is not effective. The most important reason is equalization fee is much too low. The second reason are underinformed employers. Policy should take these facts into account and increase the advantage of employing people with disabilities by introducing a higher equalization fee and communicating this to employers. To determinate the adequate rate of increase a special scientific assessment should be prepared.

Tab. 10 – Duration of consulting. Source: own research

Duration	Frequency	Percentage
More than one year	1	20.0%
6 Months	1	20.0%
One year	1	20.0%

One interviewee, as an entrepreneur with a taxi business, reported he was consulted for more than one year. The consulting expert told me that the consulting process takes between six months and one year. In this time, they meet with their clients between three and six times. Compared to most of legal guardianships, this is a very short period with only a few meetings. Only in a few cases the legal guardian can release his client into independence. Most people legal guardians are responsible for have serious illnesses. Thus, compared to budget recipients, most independent entrepreneurs have a lot more competences than people under legal guardianship.

Tab. 11 – Number of consulting sessions. Source: own research

Frequency	Frequency	Percentage
Until six	1	20.0%
Until three	1	20.0%

Tab. 12 – Factors for business openings. Source: own research

Factors	Frequency	Percentage
Special properties	4	80.0%
Supporter	4	80.0%
Supported by clerks	3	60.0%
Self-management	3	60.0%
Achieving break-even point	3	60.0%
Professional knowledge	2	40.0%
Successful application	2	40.0%
General business knowledge	2	40.0%
Car	2	40.0%

Support of entrepreneurship	2	40.0%
Clarify claims	2	40.0%
Telephone consulting	2	40.0%
Expected improvement of income	1	20.0%
Network meeting	1	20.0%
Member of a professional association	1	20.0%
Investigating possibilities of sharing economy	1	20.0%
Using all offered services	1	20.0%
IT equipment	1	20.0%
Setting priorities	1	20.0%
Possibility to have an unemployment assurance	1	20.0%
Equalization fee	1	20.0%
Effective consulting methods	1	20.0%
Entrepreneurship in combination with a part-time job	1	20.0%
Possibility to secure existence without social benefits	1	20.0%
Invitation to an information event	1	20.0%
Professional experience in the targeted business field	1	20.0%
Working hours can be self-determined	1	20.0%
Reduced travel time thanks to entrepreneurship	1	20.0%

Most of the listed factors are also important for entrepreneurs without disabilities. All interviewees pointed out the importance of backers. The latter certainly play a big role in opening a business successfully. A backer can be a clerk, a member of the family, a friend, a consultant. One interviewee had a chance to be in a job and launching her entrepreneurship in combination with a part-time job. She so reported, that being able to determinate her working hours and having the possibility to reduce travel time thanks to working from home, were further arguments for starting her own business.

Tab. 13 – Actions of persons interviewed. Source: own research

Actions	Frequency	Percentage
Seminar attendance	3	60.0%
Typical actions for entrepreneurship	3	60.0%
Research on internet	3	60.0%
Employing mini-jobber	1	20.0%
Writing a concept	1	20.0%
Call and ask specific questions	1	20.0%
Getting professional knowledge	1	20.0%
Rhetorical questions	1	20.0%

Nearly all interviewees have visited at least one seminar before starting their business. Research on the internet as one typical action for entrepreneurship was the most-listed action. Only one interviewee wrote a concept by his own (the one with dual qualifications as bank clerk and social worker). Another interviewee needed to acquire professional knowledge, he was the one, who started his business as a taxi driver.

Tab. 14 – Area of operations. Source: own research

Area	Frequency	Percentage
Social sector	1	25.0%
Legal guardianship	2	50.0%
Taxi services	1	25.0%

The social sector is one of the fields with the most employees in Germany (60% of the job market with 40 million employees). As entrepreneur with taxi services the interviewee offers also a service with high density of employees (48%) (See the table below). Only two interviewees are occupied in a very small area as legal guardians (12000 legal guardians exist in Germany, according to 0.03%).

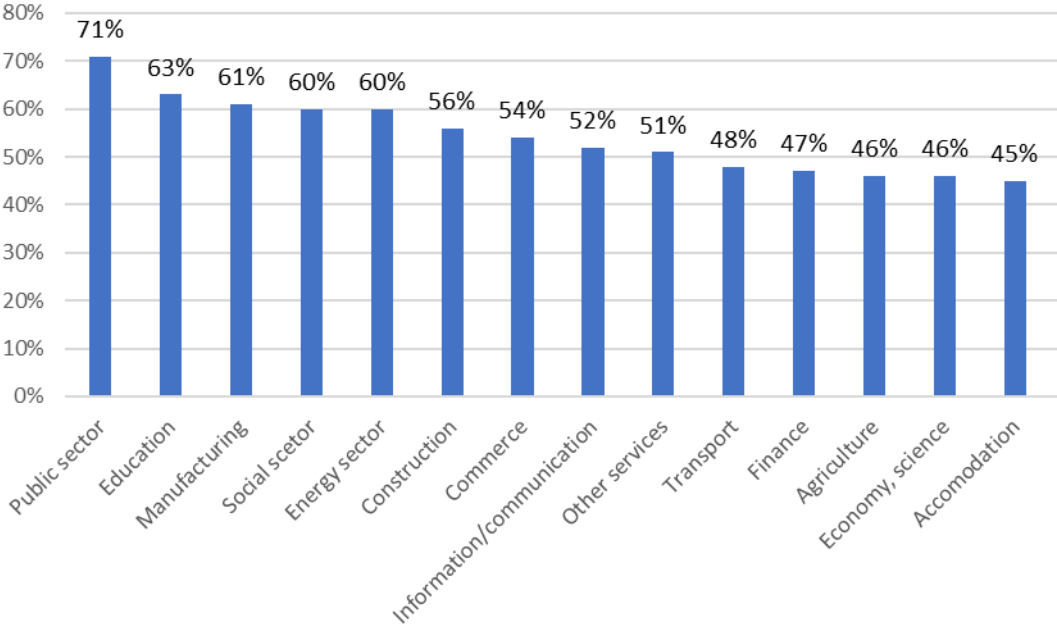

Fig. 1 – Areas of employment. Source: Kantar (2019)

According to the expert consultant two thirds of new entrepreneurs start their business in the service sector, one third in commerce, and there are barely any skilled entrepreneurs in manufacturing and handiwork. Most of their clients do not employ anyone and run only a small business with 5 % of their targeted market. He also pointed out that, according to the study about consulting, the role of consultants has changed from information gatherers to navigator, probably because obtaining information is not a problem with the internet but finding the information needed is the bigger challenge. In his opinion the transformation towards a VUCA world is not important to his clients. More important is their knowledge about their targeted group. He agrees that, even if they only use tools from the Internet, interactive software tools will gain of importance in consulting in the future. Furthermore, only three in ten clients start their business. If the clients have strong doubts, the consultant recommends ending their project.

Tab. 15 – Area of operations. Source: own research

Elements	Frequency	Percentage
Process consulting	2	50.0%
Strategic consulting	1	25.0%
Empowerment	1	25.0%
Minor self confidence	1	25.0%
Launching a business	1	30.0%
Potential to save	1	20.0%

Another important aspect is that the Enterability project has the potential to save 3.9 € on every invested Euro after five years. The problem is that the authority that invests (employment exchange) is not the same as the one that profits from the investment in terms of saving (health assurance, pension, taxes, etc.).

As an important characteristic, the consultant expert explains that their consulting approach is holistic. The consultant sees their clients one time per month on average during six months up to one year. There are six Enterability agencies. Every year they give support to 8200 entrepreneurs with disabilities.

The procedure of consulting happens in four phases: In the first phase a profile is created, in the next phase the consultant and his client get to know each other (qualification of the client, his biography, his social situation, his disabilities and barriers, his project and preparations, ...), then follows phase three (product description, marketing, financing) and the last phase, starting the business with specific support.

Enterability has a consulting concept, the consultants have a uniform statement and follow a consultant guide. A consultant should be older than 40 years, have experience in solving personal crises and in consulting and if possible, should have therapy experience of their own.

## 5 CONCLUSIONS

In times with fewer professionals and less motivation to be trained as entrepreneur Germany should support the entrepreneurship of minorities, especially of people with disabilities. Even if they do not create big enterprises with a lot of employees, the amount of social benefits can be reduced. As we have seen, some disabled entrepreneurs can even be successful and establish in specific areas. The problem is that the investing authority has no direct advantage to gain of its financial support for disabled entrepreneurs. This problem must be solved on a political level. To convince the politicians, the approach of Social return on investment (like shown on the Enterability project) is interesting and is an important element of Corporate Social Responsibility. The paper shows how a project like Enterability can bring an added value to society by consulting disabled people and so realize a social return on investment (SROI). We should consider that every successful disabled entrepreneur gets independent from social benefits, so that the SROI is obvious without the need to control the seven principles of SROI (Brest, Harvey & Low, 2009). In the same time this paper shows how important the properly procedure is important for every administration and so has an important impact on the global competitiveness of a state by offering favourable conditions to start a business. According to the ideas of global competitiveness institutions are one of the important pillars of competitiveness (Schwab & Sala-I-Martin, 2017). Not every consulting process especially in the social area like social work on youth or children can be measured by SROI, but it is recommended to institutions to apply SROI more often to evaluate social projects and so invest finances in the best way. Unfortunately, the approach of SROI is underused (Millar & Hall, 2012).

### References

- Betriebspanel (2019). Das IAB Betriebspanel. Retrieved from <https://www.betriebspanel.iab.de>
- Brest, P., Harvey, H., & Low, K. (2009). Calculated Impact. *Stanford Social Innovation Review*, 7(1), 50-56. Retrieved from <https://hewlett.org/wp-content/uploads/2016/08/CalculatedImpact.pdf>
- BDU (2017). *Facts & figures zum Beratermarkt 2016/2017*. Bonn: Bundesverband Deutscher Unternehmer.
- Destatis (2018). *Pressemitteilungen*. Retrieved from [https://www.destatis.de/DE/Themen/Gesellschaft-Umwelt/Gesundheit/Behinderte-Menschen/\\_inhalt.html](https://www.destatis.de/DE/Themen/Gesellschaft-Umwelt/Gesundheit/Behinderte-Menschen/_inhalt.html)

- Eurostat (2019). *Disability statistics – access to education and training*. Retrieved from <https://ec.europa.eu/eurostat/statistics-explained/pdfscache/34423.pdf>
- Kantar (2019). *Beschäftigungstrends*. Ergebnisse aus dem IAB Betriebspanel.
- Kloostermann, R., Van Der Leun, J., & Rath, J. (1999). Mixed Embeddedness. (In)formal Economic Activities and Immigrant Business in the Netherlands. *International Journal of Urban and Regional Research*, 23(2), 252-266. doi: 10.1111/1468-2427.00194
- List, F. (1930). *Das nationale System der politischen Ökonomie*. Berlin: Rainer Hobbing.
- Millar, R. & Hall, K. (2012). Social Return on Investment (SROI) and Performance Measurement: The opportunity and barriers for social enterprise in health and social care. *Public Management Review Volume*, 15(6), 923-941. doi: 10.1080/14719037.2012.698857
- Parish, S. L., & Cloud M. J. (2006). Financial Well-Being of Young Children with Disabilities and Their Families. *Social Work*, 51(3), 223-232. doi: 10.1093/sw/51.3.223
- Porter, M. (1990). *The competitive Advantage of Nations*. New York: The free press.
- Ravassard, M. (2018). *Persons with disabilities*. Retrieved from <https://www.right-to-education.org/issue-page/marginalised-groups/persons-disabilities>
- Röhl, K. H. (2016). *13 Vorschläge für bessere Gesetze*. Retrieved from <https://www.iwd.de/artikel/13-vorschlaege-fuer-bessere-gesetze-296287/>
- Schumpeter, P. (1987). *Theorie der wirtschaftlichen Entwicklung: Eine Untersuchung über Unternehmervergewinn, Kapital, Kredit, Zins und den Konjunkturzyklus*. Berlin: Duncker & Humblodt
- Schwab, K. & Sala-I-Martin, X. (2017). *The Global Competitiveness Report 2017-2018*. Retrieved from: <http://www3.weforum.org/docs/GCR2017-2018/05FullReport/TheGlobalCompetitivenessReport2017-2018.pdf>

## Contact information

### **Bernard Joseph-Auguste**

City University of Seattle programs Trenčín, School of Management in Trenčín  
 Panonska cesta 17, 85104, Bratislava, Slovak Republic  
 E-mail: [bernardjosephauguste@gmail.com](mailto:bernardjosephauguste@gmail.com)  
 ORCID: 0000-0003-2230-9554

doi: 10.7441/dokbat.2019.048

# OPENING PANDORA'S BOX: NEUROMARKETING AND BRAND IMAGE

*Dinko Jukić*

## **Abstract**

The paper presents the deconstruction of brand image in terms of neuromarketing and consumer behaviour theory. This paper reviews the findings from the neuroscience literature on encoding of utility in the customer brain, and provide explanations to brand phenomenon. We place particular emphasis on consumer image and impression models, as neuromarketing enables us to more accurately identify consumers' unconscious, emotional reactions when creating a marketing message. The purpose of this paper is to analyse and discuss neuromarketing from aspect of brand image. It is based on Kapferer's theory of brand identity and Damasio's theory of emotions. From the consumer's point of view, the brand represents a symbol built on impressions, associations and emotions. The problem of brand loyalty appears as a reflection of brand symbol and its image. Neuromarketing unites medicine, psychology, neurology and marketing in its interdisciplinary approach. Thus, it is an application of neuroscientific research aimed at understanding subconscious dispositions of consumer behaviour. For this purpose, neuromarketing most commonly uses fMRI to determine the intensity and specific correlations of stimuli. By following the reactions of certain parts of the brain, we are able to determine the type of psychic process that is crucial when creating a brand image. Brands communicate with consumers at the semiotic level. Such communication represents the relationship between the sender and the recipient of the message. In its semiotic meaning, the brand has become a cultural object, and as such, it not only makes the consumer self-image but also his hidden desires.

*Keywords: neuromarketing, brand, image, message, emotion*

## **1 INTRODUCTION**

The metaphor of opening the Pandora box alludes to the well-known Greek myth of Pandora (Πανδώρα). To paraphrase Pandora box in context of neuromarketing we can portray the future in the consumer behaviour. But we have to be very careful. By unravelling the consumer's emotions, we not only discover the consumer's hidden desires but also locate their unconscious motives. Neuromarketing tries to move from the cognitive aspect of consumer behaviour to the affective aspect of consumers. However, neuromarketing also raises certain ethical dilemmas. This is mainly because the information received is used to create persuasive messages to maximize the frequency of purchase decisions. One of the controversial strategies is invasive, trying to manipulate preferences that are unconscious and based on emotions. As a new theoretical concept, neuromarketing raises ethical dilemmas by forgetting an important medical rule *Primum non nocere*.

The paper consists of three parts. In the first part, we describe brand as a message. It begins with a conceptual analysis of brand image, and continues with the redefinition of the brand as a message construct. The brand is portrayed from the semiotic point of view as a sign that communicates through the consumer's impressions. The second part of the paper discusses brand image from neuroscience point of view, linking the concept of emotion with the consumer's perceptions. The author interprets conscious images and image as a mental pattern in neuromarketing doctrines. The methodology of Kapferer's brand identity, Keller's image and



Damasio's mental models was used. The third part is about neuromarketing and brand image, integrating two brand building theories into a holistic view of consumer's perceptions.

The purpose of the paper is to investigate, analyse and present the brand image from a neuroscience and neuromarketing perspective. The concept of brand, i.e. cognitive consumer perspective and brand image, was analysed to confirm the brand identity and consumer impressions. Model of neuromarketing associations, object images and mental pattern are proposed that break down the brand into impressions and brand images. We presented mental models as objects representing different brands, while we presented images as sensory modalities, specifically brand elements.

The paper analyses the brand from the consumer point of view, in accordance with Kapferer's metaphor in which identity and image are viewed on a communication relation. It also starts from the theory of Damasio's that images that consumers have about brands are created in neural models. The paper examines the consumer paradigm of creating a brand image, so it is necessary to analyse the consumer's perception. Perception makes the brand image. It is a reflection of consumer self-image. This brings us to the key question: should we open the Pandora box, if we know that emotions are an integral part of the process of logical thinking and decision making?

The field of marketing has always been looking for facts that will explain how the brain works when shopping. This is especially pronounced today because the brand is raised to the level of symbols and communicates with consumers at the semiotic level. The purchase decision is influenced by a whole range of incentives from the customer's environment. Also, the customer is at the same time a stranger because his physical needs are highly variable and difficult to classify, as they vary from individual to individual. This is why the metaphor of the black box (Kotler & Armstrong, 2008) is understood as the notion of what is in the psyche of the customer. The point is that consumer decisions and influences on buying are still largely enigmatic. Marketing research can identify who the customers are, how and where they buy, but the question of why they are buying is the biggest challenge for modern marketing.

Neuroscience theory offers us a possible answer to deciphering the black box. Neuroscience emerged in the 1970s and was largely derived from neurology (Ćorlukić, 2017). Neuroscience studies neural signalling, the nervous system, the functioning of the brain and explains how certain processes in the brain act to form behaviours. Genetic, molecular biology, anatomy, behavioural observation, and psychology methods are most commonly used in neuroscience research (Purves et al., 2016). Cognitive neuroscience is a sub-branch of neuroscience that studies the psychological functions of the brain.

Neuromarketing is most commonly observed by combining consumer behaviour theory and neuroscience theory. Dispositions of consumer behaviour are a constant subject of research, not only in neuromarketing, but also in neuroeconomics. Neuroeconomics could model the details of what goes on inside the consumer mind just as organizational economics models what goes on inside firms (Camerer et al., 2004). In fact, marketing researchers have always been interested in why consumers buy, and only the appearance of neuroscience has made it possible to medically confirm this search. The need to measure marketing effectiveness is expressed in neuromarketing. The reason is very simple, to empirically validate brand phenomena and to show the actual motives for the purchase.

## **2 BRAND AS A MESSAGE**

The brand is the message. The consumer purchases brands that are consistent with his or her self-image. Brand is the vision that drives the creation of products and service under that name

(Kapferer, 2008). These visions form the consumer's beliefs and perceptions that lead to loyalty, and ultimately, the cult brand phenomenon (Acosta and Devasagayam, 2010). In essence, we can say that brand vision is a symbiosis of an idea and its realization. An idea that represents a particular belief that the brand is communicating, that is, its specific myth, while realization makes it a tangible product.

It is necessary to distinguish identity from brand image. Identity is on the corporation side, and the image is on the consumer side. Thus, identity represents the sender of the message, while looking at the brand image as the recipient. From the above we conclude that identity precedes image (Kapferer, 2008). We understand identity as the desired image (message) that we send to the consumer. From an advertising message perspective, brand identity plays a significant role in promotion. The message affects consumers because the message transmitted by the corporation has all the security and identification elements.

If we separate ourselves from emotional, rational, and ethical appeals (Kotler & Armstrong, 2008), that influence comes from attention. A brand, as a living organism (Kapferer, 2008), consists of three categories: product, name and brand concept. When buying a brand, the brand tag most often serves the consumer to identify the origin of the product because the brand represents to the consumer the fulfilment promised by the manufacturer. But such a benefit has not always been realized. When there is no significant difference between products, consumers choose the brand on the basis of "emotional stimuli" (Temporal, 2002) rather than functional features.

Brand identity requires considerable investment, both financially and temporally, as it captures the rational and emotional components of consumer impressions. Consequently, we interpret identity as the set of all the characteristics with which a brand presents itself. The image is a picture that the brand leaves on the consumer and depends significantly on the elements of identity that, conditionally, help to create the image in the consumer. The hexagonal prism represented by Kapferer (2008) metaphorically symbolizes the diamond and its solidity and the perfect structure of the brand building. It first begins with physical features, which we take as tangible values, that is, development of identity, and ends with the self-image of the consumer, which represents emotional and rational impressions.

Brand value is the result of the sum of all positive and negative impressions. Brand identity management involves the transfer of features to the brand over time. The core of the brand, therefore, can be viewed diachronically and synchronically. The core of a brand is what the brand represents at its roots, its genetic structure (Govindarajan & Trimble, 2005) that is transmitted through time and space. Brand essence can be built up over time, it is not strictly defined in the beginning. Because of this, the brand is said to be a living organism that evolves through space and time. Synchronically, the core of the brand should be directly related to the corporate mission. Understanding brand features determines how the brand will evolve further. Accordingly, we can conclude that the brand is a dynamic category, a metaphorical living organism once created by the sender of a message, experiencing its own renaissance.

A positive brand image creates strong and unique associations in the consumer's memory. Stronger emotional impressions result in stronger consumer loyalty to brands. The brand image is closely linked to the associations that are the kind of "carriers" of the brand power, so the associations are viewed together with the image. Consumer beliefs in the power of brand are divided into two categories, brand attributes and brand benefits. Brand attributes represent the descriptive traits that characterize a product or service, and benefits denote the personal, consumer values that consumers add to the brand. Therefore, brand image must be viewed in the context of brand associations and consumer perceptions. We can conclude that image is an

integral part of the expected value that consumers want. The image is an added value of the brand and reflects a competitive advantage over other brands.

A brand is a perceptual creation of consumers. Brands are much more than products: they are networks of information and prescription (Kapferer, 2000), emotional and rational, playful and serious. A brand is an added value that enriches products and services. Brand value (Keller et al., 2008) can be reflected in how consumers react, feel, think and act with respect to the brand (Kotler & Keller, 2006). If the brand image matches the consumer image, it creates a precondition for brand loyalty. In essence, consumers tend to reflect their self-image through brands (Schiffman and Kanuk, 2004). The same is stated in consumer behaviour theory, where brand choice is viewed as an attempt to retain consonance, or avoid dissonance. Consumers seek and use information as part of their own rational problems solving, but their decision-making may not always be rational. Consumers choose products that are consistent with their images of themselves, and discard those that are inconsistent.

Because we regard the brand in this paper as a message, which it certainly is, but also as a semiotic sign, let us clarify the phenomenon of message strength. Persuasive messages are intended to reinforce, create, or change attitudes. We view attitude as a mental construct that develops through experience and influences behaviour. It is crucial to note that attitudes are learned and consumers are not born with them. The brand, as a very powerful message can affect two components of attitude: (1) belief and (2) value judgment. Beliefs are facts, and value judgment is a subjective category (Benoit & Benoit, 2013). It is obvious that consumers can have very strong value judgments (subjective categories) so they are convinced (objective categories) in their claims. This category of subjectivity is very important, consumers think they are right, but their value judgments depend on emotions.

The brand's persuasive messages are not conditioned by the message per se, but by the thoughts that that message sparks. The messages influence indirectly and stimulate thoughts, i.e. the number of thoughts and the valence of thoughts. This also means that the recipients of the message (consumers) may have thoughts or cognitions in response to the message (Perloff and Brock, 1980). Accordingly, there are two ways of persuasion (Petty and Cacioppo, 1986): central and peripheral. The central path of persuasion involves careful consideration of arguments (the content of the message), during which thoughts (cognitive responses) are generated. Keller calls this brand resonance (Keller et al., 2008). The peripheral path of persuasion means that the recipient makes no effort to think about the content of the message. Then consumers decide whether to agree to the message based on other signs.

### **3 EMOTION AND NEUROSCIENCE**

Emotional branding offers added value to the consumer, encompassing the emotional experience. Brands that consumers respond to must have one very important construct: trust. Elements common to all brands based on emotional branding are: communication and emotional charge. Emotional branding is about designing an immediate dialogue with consumers. Starting from such preferences, we can state that consumers want and expect from the brand a certain, conditionally speaking, friendly relationship (Gobe, 2002). The metaphor of a friendly connection itself is a reminder of emotional branding, that is, a specific link that consumers associate with a brand. This link is tied to the notion of consciousness.

The problem of consciousness is a combination of mental models, the so-called images of the object and sense of self-realization (Damasio, 2005). Mental models (object images) are distinguished as objects that represent various entities here, specifically the brand, while images represent sensory modalities, specifically elements of the brand. These images convey different kinds of physical properties of the object, but also the emotional reaction of the consumer.

However, the problem of consciousness is the understanding that the brain creates neural models in its neural circuits and manages to transform them into explicit mental models (images). Damasio (2005) portrays the term image as a mental pattern. They may be conscious or unconscious. Thus, by the name of images, we mean mental models whose structure is constructed from the tokens of each sensory modality (Damasio, 2005). Therefore, any symbol for the brain is an image and there is very little left over from the mental that is not an image. The senses are images, somatosensory images (Damasio, 2005).

Images are constructed when the consumer begins to engage with brands (objects) or when they reconstruct brands based on memory. These images are sometimes convergent, divergent and sometimes slow. Of course, the images that the consumer sees are not all aware. Unconscious images according to Damasio (2005) are never directly available. In essence, conscious images are only available in the first-person singular perspective (the consumer perceives the brand itself). On the other hand, neural models are only available in the third-person singular perspective. This is so because we understand the concept of consciousness as a private phenomenon of the first person singular (Damasio, 2005). Emotions are an integral part of the process of logical thinking and decision making (Damasio, 1994; Damasio, 1996). Emotions help logical thinking and reasoning, especially when it comes to personal and social issues. In fact, the emotional reaction may be weak or strong, but it is always present. Emotions are obligatory companions of behaviour (Damasio, 2005).

Somatic Marker Hypothesis (Damasio, 1996) argues that decisions made in situations that may be potentially harmful or favourable, and similar to previous experiences, cause a physical reaction that characterizes the outcome. In this sense, we understand emotion as a state of a set of variables caused by a situation or thoughts. Thus, selective reduction of emotions disrupts rationality, which is further confirmed by research in neuroeconomics (Camerer et al., 2004; Camerer et al., 2005). The ubiquity of emotions in everyday experience links every object or situation through conditioning to the core values of homeostatic regulation (Damasio, 2005). Emotion will be particularly beneficial in ambiguous situations in which decisions can only be based on a similar experience. Finally, images that consumers have about brands are created in folders (Damasio, 2005), which are another term for neural models, and these in turn are generated in nerve cells that form neural circuits.

Emotions are a multi-stage process (Judaš & Kostović, 1997). In this sense, emotions are states of readiness for specific actions. Subjective feelings known as emotions are an essential part of the consumer's experience. All emotions are expressed by visceral motor changes. The reason for this is that emotional experiences are closely linked to a visceral motor system that is inseparable from central nervous system structures that are driven by preganglionic autonomic neurons (Purves et al., 2016). In essence, higher order brain centres that manage with emotional experience are grouped in the limbic system. The broad constitution of cortical and subcortical areas includes parts of the forebrain and diencephalons that affect a set of lower motor neurons charged with somatic expression of emotional behaviour (Purves et al., 2016). Figure 1. shows the human brain and the limbic system responsible for emotion, instincts, and episodic memory. Also shows the cerebral cortex responsible for cognition, action planning and knowledge representation.

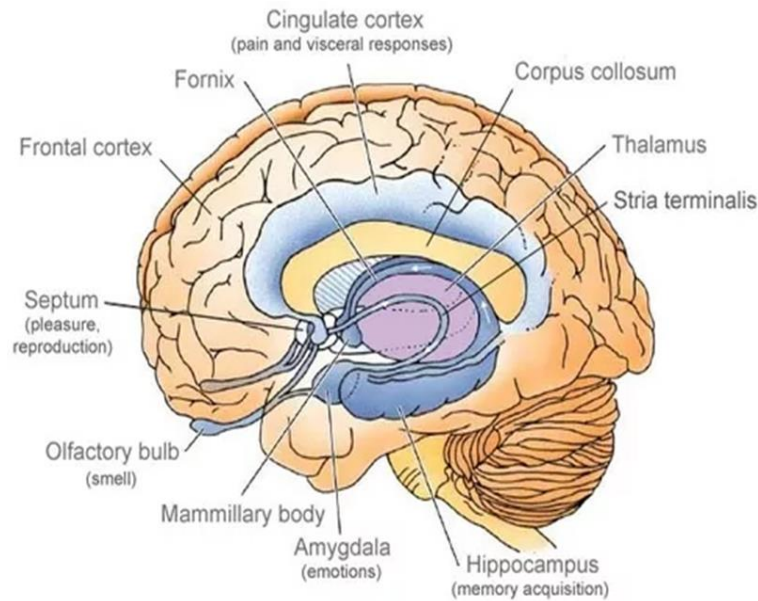

Fig. 1 – Human brain. Source: King (2019)

The same structures of the brain that process emotional signals participate in various complex brain functions, including goal-directed behaviour, interpretation and decision-making. Two particularly important components of the limbic system are the orbital and medial prefrontal cortex and amygdala. These two telencephalon regions together with the associated structures in the thalamus, hypothalamus and ventral striatum are particularly important in the expression of emotions (Purves et al., 2016). The amygdala is a complex mass of grey matter embedded in the anteromedial portion of the temporal lobe, rostral to the hippocampus (Price et al., 1987). The amygdala connects cortical areas that process sensory information with the executive systems of the hypothalamus and brainstem (Sah et al., 2003). Thus, the amygdala is involved in processing sensory experiences that have emotional meaning for the consumer.

The amygdala's role is not limited to making judgments about basic emotions, but includes a role in making social judgments (Buchanan et al., 2009). It is generally believed that the amygdala is involved in automatically responding to emotionally striking stimuli (LeDoux, 2000). The amygdala receives sensory input signals directly from certain thalamic nuclei, which means that many neurons in the amygdala respond to stimuli. We can say that the amygdala emerges as a key node in the network connecting the cortical and subcortical areas involved in emotional processing (Purves et al., 2016). The amygdala is one of the brain regions most extensively scrutinized and most frequently invoked for its critical involvement in emotion processing (Vuilleumier, 2009).

The amygdala, with its attachments to the prefrontal cortex and the basal ganglia, likely influences the selection and initiation of behaviour that aims to obtain reward and avoid punishment (Purves et al., 2016). Parts of the prefrontal cortex are also involved in the organization and planning of future behaviour, so the amygdala can make an emotional contribution to conscious and unconscious reflections. Thus, the connection between the amygdala, neocortex, and subcortical structures is due to subjective feelings. The model of emotional emotion awareness (LeDoux, 2000) probably arises from neural systems in the prefrontal cortex that leads to awareness of emotion processing. In this concept, feeling encompasses the instant conscious experience of implicit emotional processing, which comes from the circle of the amygdala and the neocortex as well as the explicit processing of semantic thoughts. Feelings are the conscious part of emotions, the aspect that permits flexibility

(Strongman, 2003). In simpler terms, we can think of emotions as the result of working memory that contains neural activity, which is related to the processing of emotional experiences.

#### 4 NEUROMARKETING AND BRAND IMAGE

Neuromarketing uses modern brain scanning techniques and methods in its research. Scanning as a way of observing brain stimulation reveals which part of the brain responds to the appearance of a mark. In fact, this determines the intensity and type of consumer stimulus correlation to the brand. Neuromarketing research can be classified as a quantitative method (Lim, 2018) because it covers research with measuring instruments. Therefore, neuromarketing largely ignores social and personal factors and is based only on brain response. This is also the biggest disadvantage of neuromarketing, as making inferences about possible consumer reactions based on chemical, neurological and physiological characteristics can be misguided, given that the human mind is very complex. Therefore, neuromarketing research should be seen as complementary to the theory of consumer behaviour, but not as a new paradigm that excludes prior psychological, sociological, and cultural insights. Neuromarketing complements theories of consumer behaviour.

Neuromarketing research shows the already formed reactions that have arisen on the basis of these factors (Lee et al., 2006), while revealing to us specific information that, thanks to neuroscience, we can accurately locate. It examines the response to a particular stimulus, which is placed in front of consumers and measure and record the reactions of the brain to a particular stimulus. Therefore, neuromarketing shows us which stimulus triggers a particular reaction. In particular, if we are going to explore brand associations, then we start from studying memory (Gluck et al., 2008) and the lawfulness of association: (1) law of contiguity, (2) law of frequency, (3) law of similarity, and (4) law of contrast. From a brand theory perspective, we interpret this as the probability that the consumer will think about the accompanying brand elements, service, competition, and person. Table 1 shows the model of neuromarketing associations, object images and mental pattern.

Tab. 1 – Model of brand associations in neuromarketing. Source: own research

Association	Pictures of the object	Mental pattern
law of contiguity	school, teacher	<i>Welton Academy +/-</i>
law of frequency	tea, cake	<i>Madelaine +/-</i>
law of similarity	Coca-Cola, Pepsi	<i>Nuka-Cola +/-</i>
law of contrast	young, old	<i>Dorian Gray +/-</i>

According to the table presented, we will explain conceptual associations from an interdisciplinary perspective. The Law of Contiguity Association alludes to the idea of shared object images, in our example school and teacher images. The school, as a metonymy of teacher and knowledge, creates the mental pattern of Welton Academy, according to the movie Dead Poets Society. The images themselves in the consumer's mind may be conscious or unconscious. Linking Robin Williams to a specific association opens the possibility of creating a brand image. The Law of Frequency Association represents the consumer's ongoing, ritualistic action. Take for example the scene from Proust's novel Combray, drinking linden tea and eating cookies. The mental pattern is, of course, petit Madelaine. Images are always conscious or unconscious, and branding elements can evoke precisely these situations. With one product (tea), in the form of a ritual (drinking tea), another product (biscuit) is added. The third association is the law of similarity. We can most easily describe it through two competing, similar brands that lead to desire. To give an example, a virtual brand, which is a metaphor for a consumer's unfulfilled desire. Finally, we can show law of contrast associations on the concept

of eternal youth / old age, that is, the image of the mental pattern of prolonged youth, a kind of escape from reality into illusion, as in Wilde's novel the picture of Dorian Gray.

Let's say that in Table 1, the mental pattern is represented as imaginary images. The concept of imaginary images is intended to highlight the very associative, imagery and imagination of the brand image. Therefore, we can also interpret the mental pattern as a form of future creation of a brand image, more precisely a university brand, person, product or service. In essence, we can say that brand vision is a symbiosis of an idea and its realization. An idea that represents a particular belief that the brand is communicating, that is, its specific myth, while realization makes it a tangible product. Does this mean that the core of a brand is inalienable to the individual consciousness of consumers? If such a concept is a unique system of individual consumer perceptions towards a more synchronous hierarchical shape in the consumer's perception through a common image, then consumers understand the value of the brand even before it is labelled. The image starts from the roots of imagination, the theory of myth and the psychological construct of self-image.

The cerebral cortex is an organ that learns, solves problems, and gives advice. The function of the cerebral cortex is to control instinctive behaviour. Also, the cerebral cortex is creative and allows for abstract thinking. We can conclude that together with the limbic system it forms moral principles. However, brand image leaves a mark in the human psyche and this stimulus results in certain emotions that will be linked in the brand recall model. This exposure of the brand and the elements of the brand to the consumer creates a mental connection, i.e. brand loyalty is created by connecting emotional connections and positive associations. From a Somatic Marker Hypothesis perspective, poor decision making occurs when somatic information (emotion) is not available to guide decision making (Bechara et al., 2000).

Complex social situations engage the orbitofrontal cortex, which then activates somatic efforts in the amygdala, hypothalamus, and brain-stem nuclei. Somatic marker permits the rapid processing of possible behavioural response and evaluation of the adaptive value of their associated outcomes (Beer & Bhanji). Somatic marker are the mechanisms that form the basis of consciousness. This is how the cognitive representation of the outside world interacts with the cognitive representation of the inner world. Let us state that Damasio (1991; 1996; 2005) uses the term representation in parallel with the term mental image. It is a pattern that is consistently linked to an object, either in relation to mental images or in relation to neural activities in a specific brain region, as can be seen from Figure 1. In essence, the mental image in the mind of the object represents a replicated structure (Damasio, 2005).

An image space is one in which images of all sensory types occur explicitly. Some of these consumer images constitute manifest mental content, and some images remain unconscious. A dispositional space is one in which images can be constructed based on memory. Brand recall relates to consumer's ability to retrieve the brand from memory when given the product category, the needs fulfilled by the category or a purchase or usage situation as a cue. So, brand recall requires that consumers correctly generate the brand from memory when given a relevant cue (Keller et al., 2008). Of course, it is much easier for a consumer to recognize a brand than recall it from memory. Therefore, the most important component of self-recognition and recall of a brand is precisely in the context of whether we are talking about a brand of a product or service. If it is a service, then recall is more important, because the consumer must remember the brand image, and if it is a product, then it is more important to recognize the elements of brand identity. Thus, the content of the image space is explicit, and the content of dispositional images is implicit (Damasio, 2005). To put it simply, everything that the consumer perceives is in a dispositional form (hidden) and waiting to be transformed into an explicit form (image).

After deconstructing the brand image, the question arises: what happens in the brain of the consumer before remembering the brand? And most importantly: is recalling a lasting memory from a neuroscientific perspective? According to the concept of reconsolidation (Alberin & LeDoux, 2013), memories are subject to change at every memory. Once stored memories can be disturbed when recalled. In particular, taking anisomycin protein synthesis inhibitor has been shown to result in a decrease in reactivated fear. Assuming change consists of two events: weakening synapses that represent memory and re-synthesis of proteins that would restore said synapses (Besnard et al., 2012).

One of the most modern and commonly used methods of brain scanning in neuromarketing is certainly functional Magnetic Resonance Imaging (fMRI). This method determines the intensity and type of correlation of certain stimuli and the adequate response of brain regions. However, the fMRI brain imaging method is less accurate and reliable than the structural brain imaging, so the results obtained from their imaging should be interpreted with critical departure (Šimić, 2019). There are two ways in which the functional structure of the brain can be examined: stimulation and rest. Stimulation represents imagining an action (buying a brand) or task-related fMRI that triggers a mental process, while inaction means resting state fMRI. Methods of fMRI stimulation is used in neuromarketing to determine the localization and lateralization of mental processes that can be controlled under experimental conditions. The localization of mental activity is performed by subtracting for each voxel the value of the signal dependent on blood oxygenation during stimulation relative to the resting period (Šimić, 2019).

Although, according to the standard model, the hippocampus is not required for evocation of memory, activation of fMRI is seen during monitoring the recall process. However, we cannot know whether this is due to an activity that is related to memory itself (Frankland & Bontempi, 2005). According to Competitive Trace Theory (Yassa & Reagh, 2013), each time a memory is reactivated, the hippocampus recontextualizes it, very much like the original clue. Over time, memories are decontextualized by rival interference between similar multiple traces, leading to the consolidation of semantic traces. All details of episodic memory are available while memories are recent. (Šimić, 2019). It is also a starting point, but also a neuroscientific confirmation of why in marketing retro motives, nostalgia and emotions are a key role in creating the brand image and its myth.

Each time a memory is reactivated, the hippocampus encodes a partially overlapping trace that attempts to reactivate in the cerebral cortex. Although these patterns are separate, in the cerebral cortex these features are amplified and the non-overlapping features are decontextualized. When stimuli are learned by repetition, they are remembered better and retained for a longer time. Research confirmed that the hippocampus was involved in associative memory retrieval regardless of learning experience and retention interval (Zhan et al., 2018). The learning experience modulated the associative memory by activating two distinct hippocampus-related brain networks. Multiple learning significantly increased activation in the hippocampus and the connectivity between the hippocampus and posterior regions and led to successful associative memory retrieval (Zhan et al., 2018). The afferent fibres reach the hippocampus mostly through the entorhinal areas. The entorhinal cerebral cortex is a major site of pathway convergence from all major associative and sensory areas of the neocortex (Šimić, 2006).

## **5 CONCLUSION**

A positive brand image creates strong and unique associations in the consumer's memory. The image is the result of the communication process. It is a perceptual stimulus that forms a mental picture. The image of the object is formed only by thought processing. Brand image can be viewed as a picture, image or complex experience, that is, the structure of attitudes, experiences



and beliefs towards a product or service. The brand image is closely linked to the associations that are the kind of “carriers” of the brand power, so the associations are viewed together with the image. Image is arguably a psychologically integrated construct. A positive brand image creates strong and unique associations in the consumer's memory.

In this paper, we presented mental models as objects representing different brands, while we presented images as sensory modalities, specifically brand elements. We have classified brand identity elements according to brand theory (Kapferer, 2008; Keller et al., 2008) to the side of sensory modalities. The notion of image is represented as a mental pattern (Damasio, 2005). These images convey different kinds of physical properties of the object, but also the emotional reaction of the consumer. The ubiquity of emotions in everyday experience connects any object or situation through conditioning. This means that the images consumers have about brands are generated in neural models, and they are generated in neural cells that form neural circuits. All emotions are expressed by visceral motor changes.

Accordingly, we can say that the hippocampus is connected to the main transmodal associative regions on the one hand, and the limbic subcortical structures on the other side of the cerebral cortex. Emotions are an integral part of the process of logical thinking and decision making (Damasio, 1996). The connection between the amygdala, neocortex, and subcortical structures is responsible for subjective feelings. Images that consumers have about brands are created in neural models (Damasio, 2000), and are understood as somatosensory, unconscious images. It is this unconscious part that is the biggest problem in the critique of neuromarketing (Jelić, 2014; Murphy et al., 2008; Yu and Zhou, 2007). Transmodal areas of the cerebral cortex are not accessible to consciousness, therefore, they influence behaviour, although they are not consciously experienced by the human (Šimić, 2006). Neuromarketing tries to move from the cognitive aspect of consumer behaviour to the affective aspect of consumers.

However, in that research, neuromarketing uses fMRI methods to identify unconscious reactions. Perception with strong echoes in the amygdala tends to produce a strong echo in the association neocortex. According to personality theory (Freud, 1940; 1982), it is a field of pure instinct, and a place of energy release. This energy is suppressed due to the effect of censorship in the conscious state, but due to the relaxation of inhibitions it is available to consumers. Therefore, Freud was right in claiming that the behaviour was influenced by unconscious motives. Also, unconscious activities include the automatic selection of cognitive-emotional behaviours adapted to the given situation. How risky this is, time will tell.

It should be noted that the paper used qualitative methods, deconstruction, analysis, identification and division. Consequently, the findings are derived in accordance with the hermeneutic spiral method and are consistent with brand theories. Brand theories are analysed from the perspective of the consumer paradigm. Also, limitations come from qualitative analysis because the theoretical triangulation method was used. A certain limitation arises from the absence of quantitative research because the paper presents inductive and theoretical processes. In further research, it is necessary to check the models and theories presented in this paper according to neuroscientific methods. In particular, the analysis of the brand resonance construct is needed to confirm or disprove current theories. This would give us a detailed insight into the peripheral path of persuasion.

## References

- Acosta, P. M., & Devasagayam, R. (2010). Brand Cult: Extending the notion of brand communities. *Marketing Management Journal*, 20(1), 165-176. Retrieved from <https://pdfs.semanticscholar.org/905a/9434e8bb31ec0e62a4c08338791dc45115b3.pdf>

- Alberin, C. M., & LeDoux, J. E. (2013). Memory reconsolidation. *Current Biology*, 23(17), 746-750. doi: 10.1016/j.cub.2013.06.046
- Bechara, A., Damasio, H., & Damasio, A. R. (2000). Emotion, decision making, and the orbitofrontal cortex. *Cerebral Cortex*, 10(3), 295-307. doi: 10.1093/cercor/10.3.295
- Beer, J. S., & Bhanji, J. P. (2011). The Neural Basis of Emotional Decision-Making. In Todorov, A., Fiske, S. F., & Prentice, D. (Eds.), *Social Neuroscience*. Oxford: Oxford University Press.
- Benoit, L. W., & Benoit, J. P. (2013). *Persuazivne poruke*. Zagreb: Naklada Slap.
- Besnard, A., Caboche, J., & Laroche, S. (2012). Reconsolidation of memory: A decade of debate. *Progress in Neurobiology*, 99(1), 61-80. doi: 10.1016/j.pneurobio.2012.07.002
- Buchanan, T. W., Tranel, D., & Adolphs, R. (2009). The Human Amygdala in Social Function. In Whalen, J. P. Phelps, A. E. (Eds.), *The Human Amygdala*. London: Guilford Press.
- Camerer, C. F., Loewenstein, G., & Prelec, D. (2004). Neuroeconomics: Why Economics Needs Brains. *The Scandinavian Journal of Economics*, 106(3), 555-579. doi: 10.1111/j.0347-0520.2004.00377.x
- Camerer, C. F., Loewenstein, G., & Prelec, D. (2005). Neuroeconomics: How Neuroscience Can Inform Economics. *Journal of Economic Literature*, 43(1), 9-64. doi: 10.1257/0022051053737843
- Čorlukić, M. (2017). Neuroznanost i psihoanaliza: neuropsihoanalitičko razumijevanje čovjeka. *Socijalne teme*, 4(4), 81-102. Retrieved from <https://hrcak.srce.hr/193387>
- Damasio A. R., Tranel D., & Damasio H. (1991). Somatic markers and the guidance of behavior: theory and preliminary testing. In Levin H.S., Eisenberg H.M., & Benton A.L. (Eds.), *Frontal lobe function and dysfunction*. New York: Oxford University Press
- Damasio, A. (1996). The Somatic Marker Hypothesis and the Possible Functions of the Prefrontal Cortex. *Philosophical Transactions of the Royal Society of London*, 351(1346). doi: 10.1098/rstb.1996.0125
- Damasio, A. (1994). *Descartes Error*. New York: Putnam.
- Damasio, A. (2005). *Osjećaj zbiljanja*. Zagreb: Algoritam.
- Frankland P. W., & Bontempi, B. (2005). The organization of recent and remote memories. *Nature Reviews Neuroscience*, 6(2), 119-130. doi: 10.1038/nrn1607
- Freud, S. (1940). *Neue Folge der Vorlesungen zur Einführung in die Psychoanalyse*. Frankfurt am Main: Fischer.
- Freud, S. (1982). *Die Traumdeutung*. Frankfurt am Main: Fischer.
- Gobe, M. (2002). *Citizen Brand: 10 Commandments for Transforming Brand Culture in a Consumer Democracy*. New York: Allworth Press.
- Govindarajan, V., & Trimble, C. (2005). Organizational DNA for Strategic Innovation. *California Management Review*, 47(3), 47-76. doi: 10.2307/41166306
- Gluck, M., Mercado, E., & Myers, C. (2008). *Learning and Memory: From Brain to Behavior*. New York: Worth Publishers.
- Jelić, N. (2014). Bihevioralna ekonomija, neuroekonomija, neuromarketing. *JAHN*, 5(9), 193-208. Retrieved from <https://hrcak.srce.hr/129410>
- Judaš, M., & Kostović, I. (1997). *Temelji neuroznanosti*. Zagreb: MD.

- Kapferer, J. N. (2008), *The New Strategic Brand Management*. London: Kogan.
- Keller, K. L., Aperia, T., & Georgson, M. (2008). *Strategic Brand Management*. London: Pearson.
- King, P. (2016). *How has the brain evolved since life began?* Mountain View: Quora. Retrieved from [www.quora.com/How-has-the-brain-evolved-since-life-began](http://www.quora.com/How-has-the-brain-evolved-since-life-began)
- Kotler, Ph., & Armstrong, G. (2008). *Principles of Marketing*. New Jersey: Pearson.
- Kotler, Ph., & Keller, K. L. (2006). *Marketing Management*. New Jersey: Pearson.
- Lajante, M., & Ladhari, R. (2019). The promise and perils of the peripheral psychophysiology of emotion in retailing and consumer services. *Journal of Retailing and Consumer Services*, 50(C), 305-315. doi: j.jretconser.2018.07.005
- LeDoux, J. E. (2000). Emotion circuits in the brain. *Annual Review of Neuroscience*, 23(1), 155-184. doi: 10.1146/annurev.neuro.23.1.155
- Lee, N., Broderick, J. A., & Chamberlain, L. (2006). What is 'neuromarketing'? A discussion and agenda for future research. *International Journal of Psychophysiology*, 63(2), 199-204. doi: 10.1016/j.ijpsycho.2006.03.007
- Lim, M. W. (2018). Demystifying neuromarketing. *Journal of Business Research*, 91(10), 205-220. doi: 10.1016/j.jbusres.2018.05.036
- Murphy, R. E., Illes, J., & Reiner, B. P. (2008). Neuroethics of neuromarketing. *Journal of Consumer Behaviour*, 7(4/5), 293-302. doi: 10.1002/cb.252
- Petty, R. E., & Cacioppo, J. T. (1986). The elaboration likelihood model of persuasion. *Springer Series in Social Psychology*, 123-205. doi: 10.1007/978-1-4612-4964-1\_1
- Perloff, R. M., & Brock, T. C. (1980). And thinking makes it so: Cognitive response to persuasion. In Roloff, M. E, Miller, G. R. (Eds.), *Persuasion: New Directions in Theory and Research*. Beverly Hills: Sage.
- Price, J. L., Russchen, F. T., & Amaral, D. G. (1987). The limbic region II: The amygdaloid complex. In Björklund, A. Hokfelt, T. (Eds.), *Handbook of Chemical Neuroanatomy, 5, Integrated Systems of the CNS, part I, Hypothalamus, Hippocampus, Amygdala, Retina*. Amsterdam: Elsevier.
- Purves, D., Augustine, G. J., Fitzpatrick, D., Hall, C. W., LaMantia, A-S., & White, E. L. (2016). *Neuroznanost*. Zagreb: Medicinska naklada.
- Sah, P., Faber, E. S., Lopez De Armentia, M., & Power, J. (2003). The amygdaloid complex: Anatomy and physiology. *Physiological Reviews*, 83(3), 803-834. doi: 10.1152/physrev.00002.2003
- Schiffman, L. G., & Kanuk, L. L. (2004). *Ponašanje potrošača*. Zagreb: Mate.
- Strongman, K. T. (2003). *The Psychology of Emotion*. Chichester: Wiley.
- Šimić, G. (2006). Neuroanatomija ponašanja. In Kocijan-Hercigonja, D. (Ed.), *Biološke osnove i terapija ponašanja*. Zagreb: Školska knjiga.
- Šimić, G. (2019). *Uvod u neuroznanost učenja i pamćenja*. Zagreb: Ljevak.
- Temporal, P. (2002). *Advanced Brand Management*. New Jersey: Wiley.
- Vuilleumier, P. (2009). The Role of the Human Amygdala in Perception and Attention. In Whalen, J. P., & Phelps, A. E. (Eds.), *The Human Amygdala*. London: Guilford Press

- Zhan, L. Guo, D., Chen, G., & Yang, J. (2018). Effects of Repetition Learning on Associative Recognition Over Time: Role of the Hippocampus and Prefrontal Cortex. *Frontiers in Human Neuroscience*, 12. doi: 10.3389/fnhum.2018.00277
- Yassa, M., A., & Reagh, Z. M. (2013). Competitive trace theory: a role for the hippocampus in contextual interference during retrieval. *Frontiers in Behavioral Neuroscience*, 7(107), 1-13. doi: 10.3389/fnbeh.2013.00107
- Yu, R., & Zhou, X. (2007). Neuroeconomics: Opening the “black box” behind the economic behavior. *Chinese Science Bulletin*, 52(9), 1153-1161. doi: 10.1007/s11434-007-0193-1

### **Contact information**

#### **Dinko Jukić, Ph.D.**

Trade and Commercial School “Davor Milas” Osijek  
Ivana Gundulića 38, 30000, Osijek, Croatia  
E-mail: dinkojukic.phd@gmail.com  
ORCID: 0000-0002-5595-4245

doi: 10.7441/dokbat.2019.049

# THE INTERNATIONAL TRANSMISSION OF THE EUROPEAN CENTRAL BANK MONETARY POLICY: EVIDENCE FROM THE CZECH REPUBLIC

*Lukáš Jursa*

## Abstract

Czech economy has long-term very close business and financial ties with its European partners, which are mainly members of euro area. Every economic, financial or monetary shock is thus very quickly spreading across the EU. However, in recent years attention has been paid to a very specific spillover effect – international transmission of ECB monetary policy. Assessment of spillover effect plays a significant role in making monetary policy decisions. The spillover effect or general transmission of exogenous monetary policy may destabilize the economic situation in the domestic country. The aim of this analysis is to identify the main channels of international monetary policy transmission for the Czech Republic. In this paper author shows that spillover of monetary shock has very similar effect to the monetary policy in the euro area. The application of the Structural Vector Auto-Regression (SVAR) model reveals that monetary restriction of ECB is rapidly affecting the development of short-term nominal interest rates in the Czech Republic. The rise in short-term nominal interest rates in the euro area has also a negative effect on economic output in the Czech Republic, peaking at 17 months. The nominal exchange rate of CZK / EUR is mainly influenced by speculative spillover of short-term capital in the first few months after monetary shock and its development will then stabilize. Moreover, it is found that the international transmission of the ECB's monetary policy does not have a major effect on the price level in the domestic economy. The robustness of the results is also ensured by analysing the overall monetary policy using the Monetary Condition Index (MCI).

*Keywords: ECB, monetary policy, spillover effect, vector autoregression, international transmission, impulse response*

## 1 INTRODUCTION

In today's globalized Europe, it is difficult for central banks of states that are not members of the euro area to pursue a completely independent monetary policy. In addition to the movement of foreign capital and speculative attacks, there are also a spillovers of the ECB's monetary policy. It is the spillover of monetary policy of important central banks that has been a topic of debate in recent years. The aim of this analysis is to identify the main channels of international monetary policy transmission for the Czech Republic.

Many authors use various modifications to VAR models to identify international monetary policy transmission. Also, in this work will be used vector autoregression and especially in its structural form, i.e. SVAR. Restrictions are applied similarly to Kim (2001). The results confirm the spillover effect of monetary policy. The ECB's monetary restriction has a major impact on the development of the Czech economy's output. There is also a rapid adjustment of interest rates. The monetary conditions in the Czech Republic are tightening in response to the euro area currency shock. The effect on the price level is not entirely conclusive. However, conventional monetary policy also affects the price level in the longer term. The robustness of the results ensured by analysing the overall monetary policy using the Monetary Condition Index (MCI).

The article contributes to the analyses already elaborated, by dividing monetary policy into conventional and overall monetary policy. In particular, the MCI published by the European Commission is used and tested. Other studies divide monetary policy but do not evaluate it as a whole system. Moreover, the work is primarily focused on the Czech environment. The work can also contribute to the discussion on the introduction of the euro in the Czech Republic. For the sake of weight, the results are compared with other analysis, e.g. Kucharčuková et al. (2016).

The results are not entirely negative in the situation of alignment of economic cycles with the euro area. However, it turns out that the ECB's monetary policy can destabilize the economic situation in the Czech Republic. It is crucial for the CNB to monitor and respond to the conventional monetary policy of the ECB in an appropriate manner and incorporate it into its models. However, this reduces the independence of monetary policy in the Czech Republic.

The outline of the paper is as follows. In section 2, author describes the general theoretical background. Section 3 presents methodology and definition of empirical models. The section also contains a description of the input data. Section 4 illustrates and discuss results of estimations. This section contains models for internal and international monetary policy transmission. Section 5 is the conclusion.

## **2 THEORETICAL BACKGROUND**

To analyse the transmission of the monetary policy of the European Central Bank to countries outside the euro area, a multidimensional model of economic time series will be applied, which according to Hušek (2007) is used for dynamic analysis of time series of two or more variables. Specifically, this method is referred to as the vector autoregression model.

Hušek (2007) argues that the econometric procedures of VAR structures were developed in the 1980s in response to large-scale macroeconomic models whose theoretical basis was highly uncertain and difficult to verify. Moreover, it is a natural link to the original one-equation autoregressive models.

According to Christiano (2012), the pioneer of the method is Christopher A. Sims, Nobel Prize winner for Macroeconomics. Sims (1980) in his work *Macroeconomics and Reality* suggested using VAR models for the following cases: forecast of economic time series, design and evaluation of economic models and assessing the consequences of alternative economic policies.

Christiano (2012) further states that designing and evaluating economic models is the most important field of application of VAR structures. Especially because of the possibility of evaluation of impulses and response of various economic shocks, VAR models are also widely used by the New Keynesian economy.

According to Chauvet and Potter (2013), VAR models are one of the central banks' key tools for developing monetary policy analysis or economic forecasting. The advantage is their relative simplicity, flexibility and ability to adapt when changing input variables.

### **2.1 Related Literature and Empirical Evidence**

A variety of econometric methods are used to analyse international monetary policy transmission. The most common approach is the construction of vector auto-regression models and subsequent analysis of response functions. Kucharčuková et al. (2016) report that VAR models for the open economy allow the assessment of currency shocks and subsequent spillovers to other currency areas. VAR models also follow the dynamics of domestic and

foreign macroeconomic variables. The fundamental assumption is that small and mostly open economies are affected by changes in the overall monetary conditions in the large monetary areas, i.e. the US or the euro area. Kim (2001) adds that monetary policy transmission in research publications is often referred to simply as a spillover effect or a currency shock spillover.

### **Example from the USA**

In most available sources considerable attention is paid to the issue of US monetary policy. A frequently cited example may be Kim (2001), where the author analyses the effect of transmission on G-7 states. The main finding is that the Fed's monetary expansion has a positive effect on the output of other G-7 states. The expansionary monetary policy of a large open economy lowers world real interest rates and thus stimulates economic growth in other countries.

Georgiadis (2015) argues that, in many countries, the spillover effect is even stronger than the monetary policy of domestic central bank. Influence depends mainly on the participation of specific states in world trade and integration of financial markets. States' efforts to prevent the transmission of monetary policy can lead to a negative impact on long-term economic growth. The easing of US monetary policy is further led by Anyan et al. (2017) to increase capital flows to emerging economies. The effect lasts for two quarters, and domestic central banks mostly react by an expansive monetary policy. Consequently, monetary conditions in domestic economies receiving shocks are significantly eased. Emerging country central banks are unable to detect international transmission channels and merely follow the Fed's decision.

Other authors primarily focus on assessing the transmission of Fed's hawkish policies. Dedola et al. (2017) argues that an unexpected monetary restriction in the US leads to a significant drop in GDP and unemployment growth in several other economies. The rate of growth of the price level then decreases especially in developed countries. Kazi et al. (2012) concludes that restrictive monetary policy is leading to a decline in GDP in Canada, Japan and Sweden. Surprisingly, the other OECD countries noted the positive effect of the Fed's restriction. Moreover, since 1980, the transmission of monetary policy has significantly strengthened. However, the results of the positive effect of the tightening of the Fed's monetary conditions on the output of advanced countries are refuted, for example, by Bluedorn and Bowdler (2011). The horizon in which the product is adversely affected is generally in the range of sixteen months. In many G-7 countries, however, the response of the economy's output to the currency shock is much faster. There are also spillovers of other macroeconomic variables. Above all, short-term interest rates abroad (relative to the US) are rising. The issue of Fed interest rate transmission is dealt with by Edwards (2010), which examines the spillover to Latin America and Asia. At the moment of changes in Fed interest rates, there is rapid and significant transmission to Latin American developing countries. A similar effect can be seen in Asia, but unlike Latin America, it has a much longer-term character.

### **Example from the euro area**

After the US, the euro area is another large monetary area where monetary policy can spillover into neighbouring countries. In addition, these non-euro area countries are often members of the European Union and cooperation and coordination of economic policies takes place between them. It is therefore appropriate to monitor the interaction. However, a large part of the studies focuses primarily on the ECB's internal transmission mechanism for the single currency area, e.g. Peersman (2004).

The reason for the greater interest may be the fact that the euro area is made up of several different countries and it is very difficult for the ECB to choose a monetary policy that will suit

all member states of euro area. It is therefore essential to first identify these impacts of transmission. This is confirmed by Peersman (2004), who argues that understanding the transmission mechanism for euro area countries is a major challenge.

However, in recent years there has been a growing interest in analysing the cross-border transmission mechanism and thus the effect of the spillover of the ECB's currency shocks. Attention is paid to the study of specific channels, for example in Moder (2017), which focuses on the countries of Southeastern Europe. The results show that the transmission of currency shocks occurs mainly through mutual trade and export activity. Interest rates only play a more significant role in a small number of countries under review. According to Potjagailo (2017), a more significant spillover of interest rates occurs mainly in the countries of Central and Eastern Europe. The expansive monetary policy of the ECB is affecting the growth of the countries' economies and decreasing interest rates. The effect on GDP is more pronounced in countries with fixed exchange rates. However, the price level is not fully symmetrically affected in countries outside the euro area and a uniform result cannot be achieved.

Kucharčuková et al. (2016) further subdivide the ECB's initial currency shock into a conventional and an unconventional part by constructing its own monetary condition index (MCI). Conventional policies have an impact on inflation and the output of economies, similarly to euro area member countries. The spillover of the unconventional monetary policy shock is strong and rapid, especially at the exchange rate. The impact on the real economy is slower and limited. In particular, inflation is not affected by the unconventional monetary policy of the ECB.

Hájek and Horváth (2018) add that the effect of price shocks is generally limited across the euro area. These results suggest that the single price law is slow to manifest. Moreover, the transmission of conventionally conducted monetary policy is more pronounced than the shock of the unconventional monetary policy of the ECB.

According to Benecká et al. (2018), similar results can be obtained when analysing the tightening of the ECB's general monetary conditions. Restrictive monetary policy is assessed using a shadow rate. The growth of the shadow rate by 25 basis points leads to a decline in real GDP in the Czech Republic of -0.5%. The impact on price developments in CEE countries is stronger than internal transmission within the euro area, averaging -0.2%. The Czech Republic and Poland are directly affected by the spillover of the ECB's monetary policy. This is due to the high degree of integration with the euro area. According to Hájek and Horváth (2018), it can be stated that Central European countries are more strongly influenced by the currency shock and the international transmission of the ECB's monetary policy. In addition, Hájek and Horváth (2016) report that the response to the currency shock is more pronounced than in some euro area Member States. Hájek and Horváth (2018) and Benecká et al. (2018) agree that Central Europe and the euro area are strongly linked with foreign trade and the interconnection of financial markets.

## **2.2 SVAR Models Approach**

Hušek and Formánek (2014) report that VAR models in some cases require the application of constraints within endogenous variables. The reason may be a large number of parameters or their statistical insignificance. These restrictions will ensure better economic verification and more significant results in the final presentation of the models. Interpretation of the results can be performed, for example, using the response function. In addition, the economic theory of unlimited VAR models cannot be avoided in the identification of SVARs.

According to Mumtaz and Rummel (2015), the VAR equation (SVAR) without a level constant takes the following form:



$$Ay_t = C(L)y_t + Bu_t \quad (2.1)$$

where  $u_t$  denotes normally distributed structural shocks, ie  $u_t \sim N(0, \Sigma)$ .  $\Sigma$  is a diagonal matrix. Matrices A and C are matrices of parameters of delayed or non-delayed endogenous variables. For the calculations, EViews7 is based on equation (2.1), but due to identification problems the coefficients cannot be estimated directly. Above all, it is necessary to adjust the equation to the standard form, which, according to Hušek (2009), does not contain feedback between model variables.

According to Mumtaz and Rummel (2015), the next step is to estimate the standard shape of an unlimited VAR model in the form:

$$y_t = A^{-1}C(L)y_t + A^{-1}Bu_t = H(L)y_t + \varepsilon_t \quad (2.2)$$

Mumtaz and Rummel (2015) report that matrices A, B and  $C_i$  for  $(i = 1, 2, \dots, p)$  in equation (2.1) are not individually detectable from the estimated matrices  $H_i$  and the general covariance matrices  $E(\varepsilon_t \varepsilon_t') = \Omega$  for shocks  $\varepsilon_t$  of reduced shape. The only way to recover equation (2.1) from equation (2.2) is by applying restrictions to the VAR model. These restrictions may be short-term or long-term.

When applying the short-term constraints Mumtaz and Rummel (2015), it is based on equation (2.2). First, the random stochastic residue,  $A^{-1}Bu_t$ , is estimated from the residue  $\varepsilon_t$ . Comparing equations (2.1) and (2.2) and their residues, the following relationship is found:

$$\varepsilon_t = A^{-1}Bu_t \quad (2.3a)$$

after adjustment:

$$A\varepsilon_t = Bu_t \quad (2.3b)$$

Mumtaz and Rummel (2015) state that the requirement to use restrictions or identification schemes is that the form is given by Equation (2.3b). This form is commonly referred to as the AB model. By introducing zero constraints on parameters A and B, we also pass constraints to the structural shape of the VAR model in the default equation (2.1).

### 3 METHODOLOGY

#### 3.1 Clarification of Model

Two types of models are developed to assess the transmission of the ECB's monetary policy. The internal transmission mechanism is examined using unlimited VAR model. The effect of the spill-over effect of the ECB's monetary policy is subsequently assessed using the SVAR model, which is created for two monetary areas. In this case, for the euro area and the Czech Republic. This method is based on the work of Kucharčuková et al. (2016) or Kim (2001), who approach the issue of international monetary policy transmission in a similar way. This system is referred to as a two-country model. Models will be defined in basic forms as VAR (1). However, the delay may subsequently vary depending on the results of the information criteria. Within the specification, the effort will not disproportionately increase the maximum delay of the model. This is due to the relatively limited analysis period and the small number of observations. In this way, a sufficient number of degrees of freedom will be ensured. Variables in models are ordered by similar works by Kucharčuková et al. (2016) and Kim (2001).

The unlimited VAR (1) model for the assessment of the intra-euro area transmission mechanism is based on equation (2.1) is specified in the form:

$$\begin{bmatrix} y_{ea_t} \\ p_{ea_t} \\ i_{ea_t} \end{bmatrix} = \begin{bmatrix} c_{y_{ea}} \\ c_{p_{ea}} \\ c_{i_{ea}} \end{bmatrix} + \mathbf{C}(L) \begin{bmatrix} y_{ea_{t-1}} \\ p_{ea_{t-1}} \\ i_{ea_{t-1}} \end{bmatrix} + \begin{bmatrix} u_{y_{ea,t}} \\ u_{p_{ea,t}} \\ u_{i_{ea,t}} \end{bmatrix} \quad (3.1)$$

where  $u_{\xi t}$  are residuals,  $c_{\xi}$  indicates level constants and  $\mathbf{C}(L)$  is a matrix of coefficients of delayed variables. No restrictions will apply to this model.

The model, based on system of equations (3.1), is suitable for analyzing the ECB's conventional monetary policy. However, for the analysis of overall monetary policy in the euro area, the short-term interest rate ( $i_{ea_t}$ ) is replaced by the monetary condition index ( $mci_{ea_t}$ ). An exogenous variable in the model is only the zero-one shift dummy. No restrictive conditions apply in this model. The aim is to let the data themselves provide the necessary information without having to know the theoretical assumptions. This approach is preferred by Sims (1980).

For the analysis of the international transmission mechanism, the SVAR model is created, which is based on equation (2.2) and (3.1). The endogenous variables of the model contain both domestic and foreign variables. It is therefore two blocks of variables. The SVAR (1) model can be defined as follows:

$$\begin{bmatrix} y_{ea_t} \\ p_{ea_t} \\ i_{ea_t} \\ y_{cz_t} \\ p_{cz_t} \\ i_{cz_t} \\ e_t \end{bmatrix} = \begin{bmatrix} c_{y_{ea}} \\ c_{p_{ea}} \\ c_{i_{ea}} \\ c_{y_{cz}} \\ c_{p_{cz}} \\ c_{i_{cz}} \\ c_e \end{bmatrix} + \mathbf{H}(L) \begin{bmatrix} y_{ea_{t-1}} \\ p_{ea_{t-1}} \\ i_{ea_{t-1}} \\ y_{cz_{t-1}} \\ p_{cz_{t-1}} \\ i_{cz_{t-1}} \\ e_{t-1} \end{bmatrix} + \begin{bmatrix} \varepsilon_{y_{ea,t}} \\ \varepsilon_{p_{ea,t}} \\ \varepsilon_{i_{ea,t}} \\ \varepsilon_{y_{cz,t}} \\ \varepsilon_{p_{cz,t}} \\ \varepsilon_{i_{cz,t}} \\ \varepsilon_{e,t} \end{bmatrix} \quad (3.2)$$

where  $\varepsilon_{\xi t}$  are residuals,  $c_{\xi}$  indicates level constants and  $\mathbf{H}(L)$  is a matrix of coefficients of delayed variables. Short-term restrictions will be applied using the AB model (2.3b). The reason is the application of theoretical knowledge defined according to Kim (2001) and the effort to prevent the influence of the domestic economy on the foreign currency area. In particular, it is assumed that a small open economy is not capable of substantially affecting the development of macroeconomic variables in the euro area (Kucharčuková et al., 2016). In the study, this assumption is valid only for a short period. An exogenous variable in the model is only the zero-one shift dummy.

The short-term restrictions on matrices are defined based on Kim (2001) as follows:

$$A = \begin{pmatrix} 1 & 0 & 0 & 0 & 0 & 0 & 0 \\ a_{21} & 1 & 0 & 0 & 0 & 0 & 0 \\ 0 & 0 & 1 & 0 & 0 & 0 & 0 \\ 0 & 0 & 0 & 1 & 0 & 0 & 0 \\ a_{51} & 0 & 0 & a_{54} & 1 & 0 & 0 \\ 0 & 0 & 0 & 0 & 0 & 1 & 0 \\ a_{71} & a_{72} & a_{73} & a_{74} & a_{75} & a_{76} & 1 \end{pmatrix} \quad B = \begin{pmatrix} b_{11} & 0 & 0 & 0 & 0 & 0 & 0 \\ 0 & b_{22} & 0 & 0 & 0 & 0 & 0 \\ 0 & 0 & b_{33} & 0 & 0 & 0 & 0 \\ 0 & 0 & 0 & b_{44} & 0 & 0 & 0 \\ 0 & 0 & 0 & 0 & b_{55} & 0 & 0 \\ 0 & 0 & 0 & 0 & 0 & b_{66} & 0 \\ 0 & 0 & 0 & 0 & 0 & 0 & b_{77} \end{pmatrix} \quad (3.3)$$

The first block from (3.2) SVAR model is specified as euro area macroeconomic variables. According to Kim (2001),  $y_{ea_t}$  and  $p_{ea_t}$  are exogenous to other model variables. In addition, restrictions are applied to prevent the effects of domestic variables on the euro area. The third equation is the reaction function of ECB's monetary policy. Restrictions are again applied to transmission from the domestic economy and, moreover, to the price level and output of the economy. This is mainly due to information delays in these quantities. Data on product and price level are not available within a month. The interaction of variables in the block for the home currency area is specified similarly. However, international transmission is not limited in the short term. For example, the floating exchange rate in the last equation flexibly adapts to all

currency shocks. Specification thus defined can be found in matrices (3.3). Restrictions remain the same in case of replacing  $i_{ea_t}$  by  $mci_{ea_t}$ .

### 3.2 Data and Variables

The data set contains monthly observations for the Czech Republic and the euro area. The total number of euro area countries surveyed is the current number of members EA-19, from 1 January 2015. The data are aggregated and the euro area is viewed as a complete monetary area.

The total number of monthly observations without time series adjustments is 232. The analyzed period is 2000M01 to 2019M04. Input variables of the models include data on the output of the economy, price level, short-term interest rate, exchange rate and overall monetary condition. Time series are obtained from the ČNB (2019), Eurostat (2019), ECB (2019) and the database of the European Commission, EC (2019). The variables and their sources are described in the Tab. 1. Basic descriptive statistics are also included. Seasonal adjustment was performed in the EViews7 using the moving average method.

Tab. 1 – Deceptive statistics and sources of input variables. Source: own research

Variable	Source	Description of the variable	Min	Median	Max	Sdev
$p_{cz}$	Eurostat	Harmonized index of consumer prices (HICP) for the Czech Republic, 2015 = 100, seasonally adjusted.	72.739	91.703	106.89	10.009
$i_{cz}$	ARAD	PRIBOR 3M, monthly average in %.	0.280	1.915	5.570	1.562
$e$	ARAD	Nominal exchange rate CZK / EUR, deflated by national price level (described by HICP).	23.975	27.798	49.939	7.173
$y_{cz}$	Eurostat	Industrial production index for the Czech Republic, 2015 = 100, seasonally adjusted.	58.500	89.950	115.300	14.474
$p_{ea}$	Eurostat	Harmonized index of consumer prices (HICP) for the euro area, 2015 = 100, seasonally adjusted.	75.308	97.393	104.738	8.754
$i_{ea}$	ECB	EURIBOR 3M, monthly average in %.	-0.330	1.487	5.113	1.753
$y_{ea}$	Eurostat	Industrial production index for the euro area, 2015 = 100, seasonally adjusted.	86.700	98.250	110.300	4.715
$mci_{ea}$	EC	Monetary condition index, weighted average interest rate and real effective exchange rate.	-3.892	-1.781	1.536	1.255
$dummy$	-	Shift dummy takes value 0 and 1 (after the collapse of Lehman Brothers).	0	-	1	-

**Notes:** CZ abbreviation refer to the two-digit ISO country code, EA stands for the euro area.

Data are examined on a monthly basis for more accurate and conclusive results. This is also an argument for using the industrial production index (IPI), which is published monthly, unlike gross domestic product (GDP). This makes it possible to significantly increase the number of observations and degrees of freedom in the models.

Variables can be divided into two blocks: time series for the macroeconomic situation in the Czech Republic and the euro area. In this context, the Czech Republic is viewed as a monitored, domestic economy and whose variables are endogenous. The euro area is then a foreign currency area and time series are exogenous variables. In general VAR models, this breakdown is not essential because all variables are endogenous, as reported by Sims (1980). However, it is necessary to define in terms of the direction of ECB monetary policy transmission at the theoretical level and in the design or identification of structural SVAR models.

In addition, a zero-one shift dummy is created. The aim is to incorporate into the models a possible structural change after the fall of Lehman Brothers and the subsequent financial

crisis. Therefore, since September 2008, shift dummy has taken on a variable value and is specified on the basis of similar work, e.g. Kucharčuková et al. (2016).

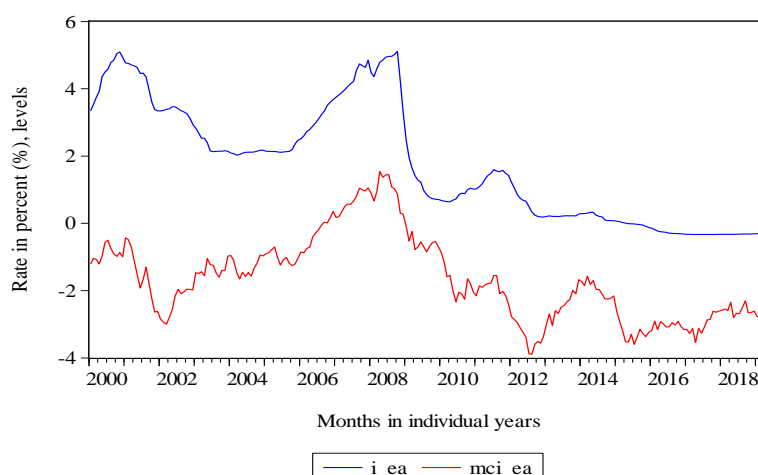

Fig. 1 – Short-term interest rate and monetary condition index developments in the euro area.

Source: ECB (2019) and EC (2019)

The ECB's currency shock is approximated by changes in the short-term nominal interest rate and the monetary condition index. Therefore, these variables are placed in the Fig. 1. The graph shows that the overall monetary policy is way more expansionary. This is due to the inclusion of both conventional, unconventional policies and also because of the construction of this index. Until 2009, both variables have developed very similarly

In the development of short-term interest rates, we can notice a significant decline in 2008 and the following years. This is due to the ECB's response to the economic crisis and the easing of conventional monetary policy. Among other things, according to Kucharčuková et al. (2016), other unconventional monetary policies were also introduced, which increased the central bank's balance sheet. After reaching the zero lower bound of short-term nominal interest rate, the role of unconventional instruments has increased even more.

Tab. 2 – Summary results. Source: own research

	ADF <sup>a</sup>		KPSS <sup>b</sup>		ADF		KPSS		ADF		KPSS	
	Estimation in levels				Month-on-month percentage changes				Annual percentage changes			
<i>p_cz</i>	-1.693	0.217	***	-12.358	***	0.062	-3.577	**	0.063			
<i>i_cz</i>	-1.387	0.135	*	-4.727	***	0.197	*	0.03	0.208	**		
<i>e</i>	-1.865	0.444	***	-11.941	***	0.055	-3.96	**	0.07			
<i>y_cz</i>	-1.813	0.157	**	-19.088	***	0.071	-3.692	**	0.073			
<i>p_ea</i>	-0.12	0.387	***	-2.817		0.066	-3.171	*	0.07			
<i>i_ea</i>	-2.835	0.102		-11.027	***	0.038	13.663	***	0.029			
<i>y_ea</i>	-2.867	0.129	*	-5.856	***	0.051	-4.208	***	0.05			
<i>mci_ea</i>	-1.696	0.252	***	-15.065	***	0.077	10.661	***	0.056			

<sup>a</sup>  $H_0$  for (ADF): the variable has a unit root.

<sup>b</sup>  $H_0$  for (KPSS): the tested variable is stationary.

**Notes:** the description and characteristics of the variables are given in Tab 1, the *t*-statistics for the ADF test and the *LM*-statistics for the KPSS test are reported, \* 10%, \*\* 5% and \*\*\* 1% significance level.

An important prerequisite for the application of the VAR model is to ensure the stationarity of time series. However, most macroeconomic time series are not stationary and can be assumed to be the case here. The variables from the Tab. 1 were therefore tested by stationary statistical tests (ADF and KPSS). A summary of the results can be found in the Tab. 2.

After considering the results, all variables entering the model will be in their annual percentage changes. The only exception are short-term nominal interest rates. This is because it is common practice to keep these quantities at their levels, e.g. Kucharčuková et al. (2016). If the VAR model passes the overall stability test, this should not be a problem.

## **4 RESULTS AND DISCUSSION**

In the following part of the thesis, the results of the analysis of the internal transmission mechanism and the spillover effect outside the euro area will be presented. It is based on models (3.1) and (3.2). The methods used to assess the shocks of ECB are Impulse response functions (IRF). The key period for IRF is the monetary policy horizon (12 to 18 months). However, the maximum rated period will be up to 50 months. The reason for such a long period is to verify the overall disappearance of the currency shock. Only statistically significant shocks will be reported. The evaluation will focus on the peaks of the response to the currency shock.

The VAR models (3.1) and (3.2) are designed with the least possible delay. This is due to the relatively short analysis period and the low number of observations. All models are designed with a maximum delay of two periods. Only the SVAR model (3.2) with MCI shock has a maximum delay of one period. The accuracy of this specification is also verified with SBIC (Schwarz-Bayesian Information Criterion) a HQIC (Hannan-Quinn Information Criterion). AIC (Akaike's Information Criterion) is not used because the delay length asymptotically overstates.

All published VAR models passed the stability test using the roots of the autoregressive polynomial. The results are given in annex A.1. Impulse response functions (IRF) of models are also stable. This can be observed by the gradual disappearance of monetary shock in Fig. 2 and Fig. 3. Thus, the short-term nominal interest rate in levels did not have a major impact on the overall stability of the model. All the charts show impulse responses with 95% confidence bands. Method used for construction of confidence bands is analytic (asymptotic).

### **4.1 Euro area monetary policy**

First, the impact of the ECB's conventional monetary policy will be assessed. Euribor (3 month) is used as proxy for main interest rate of ECB. This is a common approach according to Kucharčuková et al. (2016). The results in Fig. 2 show that the tightening of conventional monetary policy has a negative impact on output and the price level in the euro area. However, this effect is particularly noticeable in the longer period.

For example, the output of the economy reacts first by a growth of 0.43% with a peak in four months. Subsequently, its decline -0.4% with a peak in 18 months. The required result by the central bank occurs only with a higher delay. The initial increase can be explained by the efforts of producers to borrow funds with lower interest rates before rates increase in economy as a result of tightening of monetary policy. Companies are probably trying to finance already prepared investment projects with a low interest rate on loans. These additional funds lead to short-term production growth. The economy is still rising at this point and producers are trying to meet the significant demand pressures. Businesses have a positive economic sentiment. There is an increase in final consumption expenditure of households and firms in the economy. The lack of production factors should lead to a short-term increase in inflationary pressures, but this result has not been confirmed (not statistically significant).

Subsequently, however, interest rates on loans will be adjusted as a reaction to the interbank market and a monetary restriction. The interest rate differential to major economies will also grow. The euro will strengthen against major foreign currencies. This will lead to a decline in

investment activity and in competitiveness of producers. Rising interest rates will reduce household consumption and the overall amount of loans. It will be more advantageous for economic entities to save money than to finance consumption. Output of the euro area will therefore start to decline. The economy is cooling, and the central bank has achieved its goal. The result of the GDP decline (mainly in longer period) is in line with other studies, e. g. Kucharčuková et al. (2016), Benecká et al. (2018), Hájek and Horváth (2018). However, the overall effect of conventional monetary policy and its horizon vary slightly across studies.

The price level reacts to the currency shock at the 29-month horizon. It turns out that production reacts more flexibly to the change in monetary policy than the price level. The overall effect is also significantly smaller (-0.035%). Rather, the long horizon suggests that the price level is not fundamentally affected by conventional monetary policy.

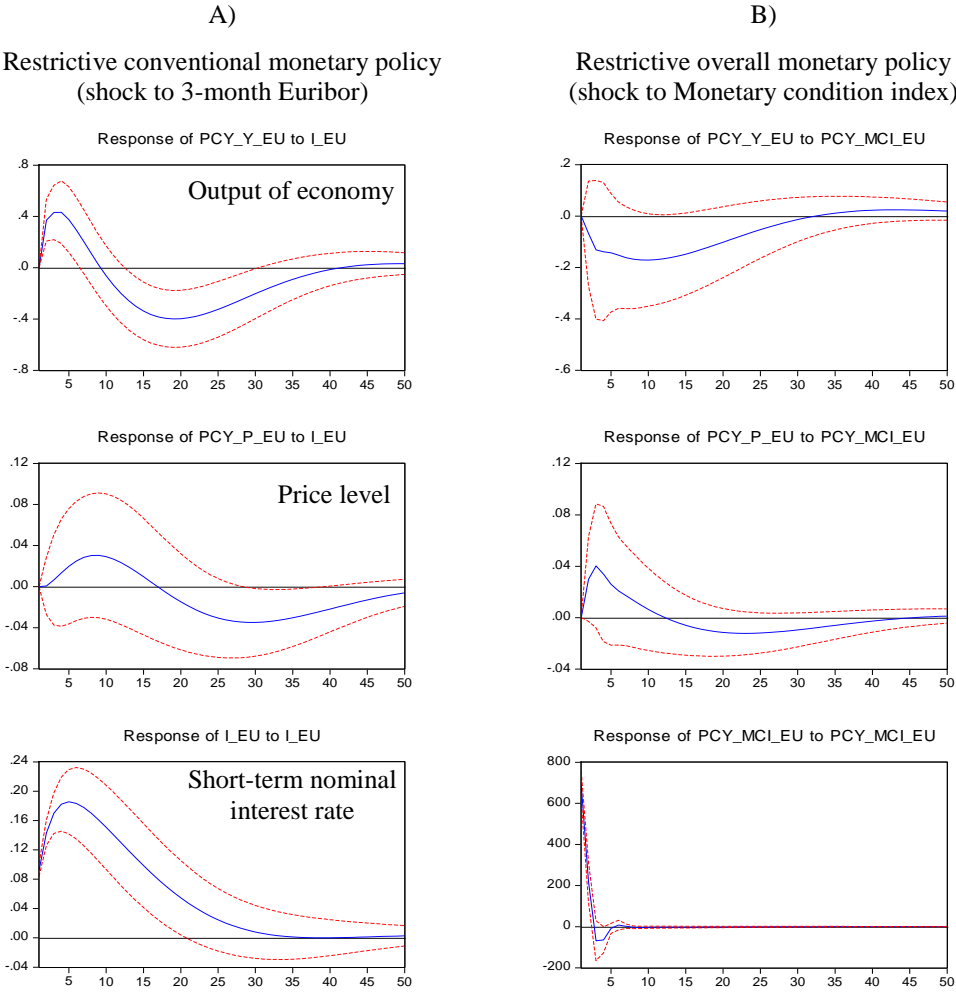

Fig. 2 – Impulse response functions (IRF) for the transmission of monetary policy within the euro area.

Source: own research

Shock value is one standard deviation  $\pm$  2 S.E. The variables that respond to shocks are the output of the economy and the price level. The VAR model is defined in (3.1). Shock to 3-month Euribor (A) and shock to overall MCI (B). Blue line are responses and red dots are 95% confidence bands. The horizontal axis indicates the individual months, the vertical axis indicates the year-on-year percentage change and interest rates are in levels.

When assessing overall monetary policy, it is found that currency shocks have a much faster effect on economies. The internal transmission of overall monetary policy is therefore highly flexible. For example, the output reacts already within 8 months. The overall effect is -0.17%.

This is a weak response compared to conventional monetary policy. The output of the economy no longer responds to the currency shock by a step increase. This is only a gradual decline in economic activity. The results also show that the price level does not respond to currency shocks at all.

It also appears that unconventional monetary policy does not increase the overall shock effect, but only accelerates the overall horizon of efficiency. Obviously, transmission acts quite differently for conventional and unconventional monetary policy. If the central bank wants to radically change economic development, it is preferable to use conventional policy. In the case of fine-tuning, it is preferable to use the instruments of unconventional monetary policy, which are also effective immediately. The assumption is that interest rates do not move too low to zero and can be used. Otherwise, the central bank does not have much room for conventional policy.

## **4.2 Spillover effect**

The internal transmission of the ECB's monetary policy described in the previous section is the starting point for further analysis. In particular, it serves for comparing the impacts of a currency shock in two currency areas. The following text describes the international transmission of the currency shock to the Czech Republic. The results can be found in Fig. 3. The currency shock spillover is again divided into two parts (overall and the conventional monetary policy). Results of Impulse response functions for SVAR are in annex A2 (conventional monetary policy) and A3 (overall monetary policy).

### **Spillover of conventional monetary policy**

The results show that the short-term nominal interest rate in the EU initially causes a shock to production in the Czech Republic. This short-term effect will increase the output of the economy by 0.38% at the horizon of 3 to 4 months. The Czech economy thus reacts at the same horizon as the euro area, but the overall effect is dampened. This result stems mainly from increased consumption and investment activity in the euro area, which is also driving production in the Czech Republic. Increased demand in the euro area and positive economic sentiment are pushing domestic economic output in the short term. The reason for this production shock is therefore different from that of internal transmission in the euro area.

Subsequently, however, the Czech economy also cooled in response to rising nominal interest rates and an overall slowdown in economic activity in the euro area. Reaction peaked in 17 months with an overall effect of -0.38%. Compared to the euro area, the reaction is slightly faster, but the impact is not so significant (-0.4% in the case of internal transmission). Kucharčuková et al. (2016) states that the impact on the output of the economy is even faster at 12 months. Using shadow rate Hájek and Horváth (2018) show that the domestic economy reacts negatively after 8 months. The ECB's monetary policy thus affects economic developments in the Czech Republic in a similar way as in the euro area. Moreover, the reaction of the foreign shock is at the CNB's monetary policy horizon. This finding is crucial because it seems that monetary policy in the Czech Republic may not be completely independent. This is also evidenced by the development of interbank interest rates. The short-term nominal interest rate adapts very quickly to developments in the euro area at the 4-month horizon. There is therefore a rapid tightening of monetary conditions in response to the ECB's monetary policy.

Thus, interest rates adjust quickly and there are no significant changes in the interest rate differential. The development of the nominal exchange rate also depends on the stable interest rate differential. The results show that the exchange rate has stabilized after the Czech crown suddenly strengthened. The reaction of the nominal exchange rate mainly reflects rapid shifts in speculative capital following the tightening of monetary dampness in the euro area.

Therefore, the rise in short-term interest rates does not affect the depreciation of the Czech crown and its development is not fundamentally affected in the longer term.

The price level in the domestic economy is not affected by the currency shock. Similar results were obtained in the analysis of internal transmission within the euro area. However, it does not decrease even in the longer term. Kucharčuková et al. (2016) states that a change in conventional monetary policy has a negative impact on the price level at the 28-month horizon. Such a long horizon is rather indicative of the insignificant reaction of the price level to the currency shock. In general, however, the interpretation of the reaction of changing the price level is very problematic for the reason known as price puzzle. According to Estrella (2014), this is a situation when an unexpected monetary policy restriction leads to an increase in inflation in the IRF. This is supported by Benecká et al. (2018), who claims that the effects on the price level is in many cases not accurately estimated.

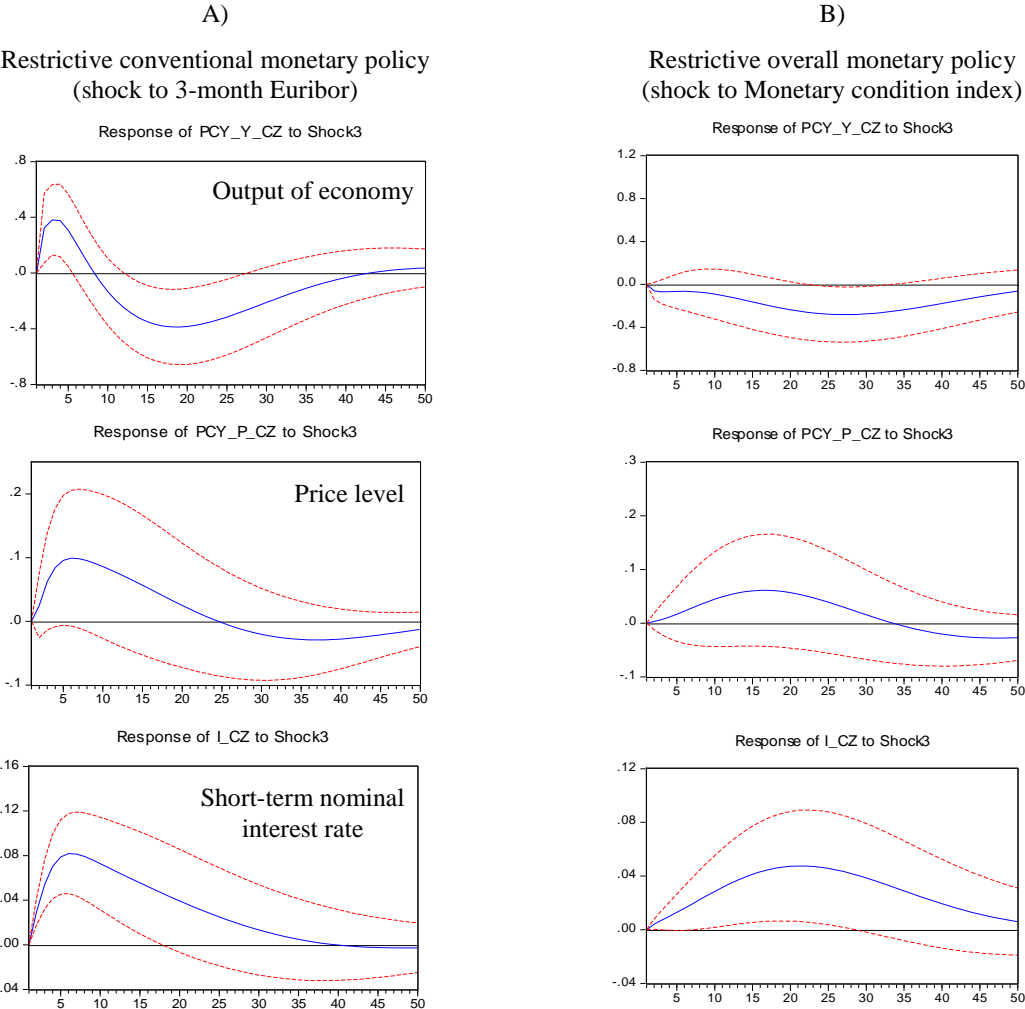

Fig. 3 – Impulse response functions (IRF) for the international transmission of ECB monetary policy.

Source: own research

Shock value is one standard deviation  $\pm$  2 S.E. The variables that respond to shocks are the output of the economy, the price level, short-term nominal interest rate and exchange rate. The SVAR model is defined in (3.2). Shock to 3-month Euribor (A) and shock to overall MCI (B). Blue line are responses and red dots are 95% confidence bands. The horizontal axis indicates the individual months, the vertical axis indicates the year-on-year percentage change and interest rates are in levels.



## **Spillover of overall monetary policy**

The spillover of the overall monetary policy is assessed primarily to ensure the robustness of the results. According to the impulse response, it is possible to conclude that the monetary restriction of the overall monetary policy leads to a negative impact on the output of the economy. However, the overall effect is not so pronounced, and the reaction horizon is shifted. The domestic economy thus responds more strongly to changes in the short-term interest rate in the euro area. However, the only fundamental difference is the response in the first months of the currency shock. There is no growth in the output of the economy.

When evaluating the reaction of short-term interest rates, it is found that the tightening of monetary conditions in the Czech Republic occurs after a longer period. However, the adjustment of short-term nominal interest rates is again relatively flexible. The overall effect is also about half less than in the case of a shock to Euribor. As in the case of conventional monetary policy, the nominal exchange rate is not fundamentally affected. Moreover, there is no speculative effect on the exchange rate in the first months after the currency shock. This result is positive because there is no significant increase in uncertainty in the economy. The impact on the price level is very similar to that of conventional monetary policy. In the SVAR model, the problem with price puzzle again appears. The effect on the price level is therefore not conclusive.

Given the results of conventional monetary policy, it can be concluded that unconventional monetary policy dampens the spillover effect of the overall monetary policy. Unconventional monetary policy seems to have no major influence on the Czech Republic. The key to the domestic economy is therefore to monitor mainly changes in short-term interest rates in the euro area.

## **5 CONCLUSION**

The international monetary policy transmission is assessed using structural vector autoregression (SVAR). Conventional monetary policy is primarily evaluated, but models for overall monetary policy have also been designed to verify the robustness of results. The internal transmission mechanism within the euro area is also evaluated to compare the results. It is the currency shock of the ECB's conventional monetary policy that has a negative impact on the output of the economic in the Czech Republic. There is also a rapid adjustment of interest rates. Due to the stable interest rate differential, the nominal exchange rate is not fundamentally affected. The development of the price level is also not primarily affected. In particular, the monetary restriction in the euro area will be reflected in the price level only after a significantly longer period. The impact of the overall monetary policy is dampened, and the horizon is prolonged. This is probably due to a lower spillover of unconventional monetary policy.

The thesis focuses mainly on the Czech environment of monetary policy. The paper contributes to the discussion on independent monetary policy and the possible introduction of the euro. Compared to other analysis, the period under review is significantly increased and the overall monetary policy is tested using the Monetary condition index published by European Commission. It is crucial for the CNB to monitor and respond to the conventional monetary policy of the ECB in an appropriate manner and incorporate it into its models. If there is a spillover of monetary policy in the face of different economic cycles, the CNB must be prepared to react and prevent the destabilizing effect of the currency shock in the euro area. The CNB follows the ECB's monetary policy. However, this reduces the independence of monetary policy in the Czech Republic. The key finding is that the spillover of the ECB's monetary policy into the Czech Republic is as significant as the implementation of monetary policy in the euro area.

## Acknowledgement

This paper was financially supported within the VŠB–Technical University SGS grant project No. SP2019/119 (Econometric Modeling of Fiscal, Monetary and Financial Aspects of the European Economies).

## References

- Anaya, P., Hachula, M., & Offermanns, C. J. (2017). Spillovers of U.S. unconventional monetary policy to emerging markets: The role of capital flows. *Journal of International Money and Finance*, 73(B), 275-295. doi: 10.1016/j.jimonfin.2017.02.008
- Benecká, S., Fadejeva, L., & Feldkircher, M. (2018). Spillovers from Euro Area Monetary Policy: A Focus on Emerging Europe. *CNB Working Paper Series*, 2018(2), 1-29. Retrieved from [https://www.cnb.cz/export/sites/cnb/en/economic-research/.galleries/research\\_publications/cnb\\_wp/cnbwp\\_2018\\_02.pdf](https://www.cnb.cz/export/sites/cnb/en/economic-research/.galleries/research_publications/cnb_wp/cnbwp_2018_02.pdf)
- Bluedorn, J. C., & Bowdler, C. (2011). The open economy consequences of U.S. monetary policy. *Journal of International Money and Finance*, 30(2), 309-336. doi: 10.1016/j.jimonfin.2010.11.001
- Chauvet, M., & Potter, S. (2013). Forecasting Output. In G. Elliott & A. Timmermann (Eds.), *Handbook of Economic Forecasting* (141-194). Amsterdam: North Holland.
- Christiano, L. J. (2012). Christopher A. Sims and Vector Autoregressions. *Scandinavian Journal of Economics*, 114(4), 1082-1104. doi: 10.1111/j.1467-9442.2012.01737.x
- ČNB. (2019). *ARAD – Systém časových řad – Česká národní banka*. Retrieved from [cnb.cz/cnb/STAT.ARADY\\_PKG.STROM\\_SESTAVY?p\\_strid=AECA&p\\_sestuid=&p\\_lang=CS](http://cnb.cz/cnb/STAT.ARADY_PKG.STROM_SESTAVY?p_strid=AECA&p_sestuid=&p_lang=CS)
- Dedola, L., Rivolta, G., & Stracca, L. (2017). If the Fed sneezes, who catches a cold? *Journal of International Economics*, 108(1), S23-S41. doi: 10.1016/j.jinteco.2017.01.002
- ECB. (2019). *ECB Statistical Data Warehouse*. Frankfurt am Main: ECB. Retrieved from <https://sdw.ecb.europa.eu/home.do>
- Edwards, S., (2010). The international transmission of interest rate shocks: The Federal Reserve and emerging markets in Latin America and Asia. *Journal of International Money and Finance*, 29(4), 685-703. doi: 10.1016/j.jimonfin.2010.01.003
- Estrella, A. (2014). The Price Puzzle and VAR Identification. *Macroeconomic Dynamics*, 19(8), 1880-1887. doi: 10.1017/S1365100514000200
- European Commission. (2019). *Monetary conditions index*. Brusel: European Commission. Retrieved from [https://ec.europa.eu/info/business-economy-euro/indicators-statistics/economic-databases/monetary-conditions-index\\_en](https://ec.europa.eu/info/business-economy-euro/indicators-statistics/economic-databases/monetary-conditions-index_en)
- Eurostat. (2019). *Database – Eurostat*. Luxembourg: European Commission. Retrieved from <https://ec.europa.eu/eurostat/data/database>
- Georgiadis, G. (2015). Determinants of global spillovers from US monetary policy. *Journal of International Money and Finance*, 67, 41-61. doi: 10.1016/j.jimonfin.2015.06.010
- Hájek, J., & Horváth, R. (2016). The Spillover Effect of Euro Area on Central and Southeastern European Economies: A Global VAR Approach. *Open Economies Review*, 27(2), 359-385. doi: 10.1007/s11079-015-9378-4

- Hájek, J., & Horváth, R. (2018). International spillovers of (un)conventional monetary policy: The effect of the ECB and the US Fed on non-euro EU countries. *Economic Systems*, 42(1), 91-105. doi: 10.1016/j.ecosys.2017.10.001
- Hušek, R. (2007). *Ekonomická analýza*. Praha: Oeconomica.
- Hušek, R., & Formánek, T. (2014). Alternativní specifikace, odhad a identifikace vektorových autoregresí. *Acta Oeconomica Pragensia*, 22(4), 52-72. doi: 10.18267/j.aop.446
- Hušek, R. (2009). *Aplikovaná ekonometrie: teorie a praxe*. Praha: Oeconomica.
- Kazi, I. A., Wagan, H., & Akbar, F. (2012). The changing international transmission of U.S. monetary policy shocks: Is there evidence of contagion effect on OECD countries. *Economic Modelling*, 30, 90-116. doi: 10.1016/j.econmod.2012.07.020
- Kim, S. (2001). International transmission of U.S. monetary policy shocks: Evidence from VAR's. *Journal of Monetary Economics*, 48(2), 339-327. doi: 10.1016/S0304-3932(01)00080-0
- Kucharčuková, O. B., Claey's, P., & Vašíček, B. (2016). Spillover of the ECB's monetary policy outside the euro area: How different is conventional from unconventional policy? *Journal of Policy Modeling*, 38(2), 199-225. doi: 10.1016/j.jpolmod.2016.02.002
- Moder, I. (2017). Spillovers from the ECB's Non-Standard Monetary Policy Measures on South-Eastern Europe. European Central Bank Working Paper, 2095, 1-39. doi: 10.2866/830401
- Mumtaz, H., & Rummel, O. (2015). Recent developments in structural VAR modelling. *Economic Modelling and Forecasting*, 1-43. Retrieved from <https://cmi.comesa.int/wp-content/uploads/2016/03/Ole-Rummel-10-Feb-Exercise-on-SVARs-and-monetary-policy-EMF-EAC-9-13-February-2015.pdf>
- Peersman, G., (2004). The Transmission of Monetary Policy in the Euro Area: Are the Effects Different Across Countries? *Oxford Bulletin of Economics and Statistics*, 66(3), 285-308. doi: 10.1111/j.1468-0084.2004.00080.x
- Potjagailo, G., (2017). Spillover effects from Euro area monetary policy across Europe: A factor-augmented VAR approach. *Journal of International Money and Finance*, 72, 127-147. doi: 10.1016/j.jimonfin.2017.01.003
- Sims, C. (1980). Macroeconomics and Reality. *Econometrica*, 48(1), 1-48. doi: 10.2307/1912017

## Contact information

### **Bc. Lukáš Jursa**

VŠB-Technical University of Ostrava, Faculty of Economics  
 Sokolská tř. 33, 70200 Ostrava, Czech Republic  
 E-mail: lucas.jursa@gmail.com  
 ORCID: 0000-0002-5734-7262

doi: 10.7441/dokbat.2019.050

# APPENDIX

A1: AR root tables for models (3.1) and (3.2), stability tests. Source: own research

AR root table for VAR (A)

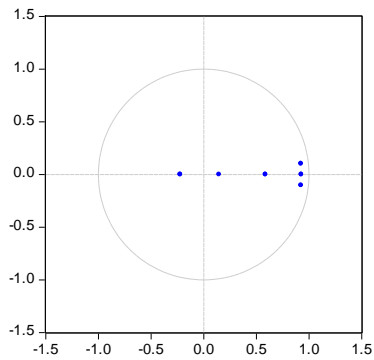

AR root table for VAR (B)

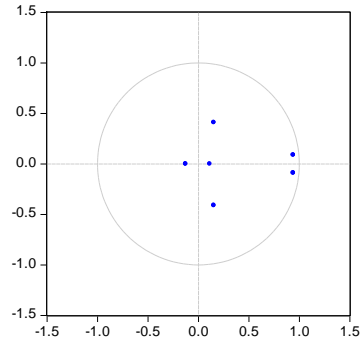

AR root table for SVAR (A)

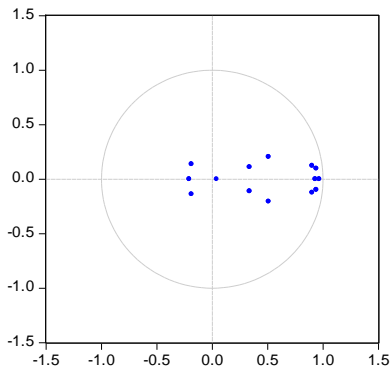

AR root table for SVAR (B)

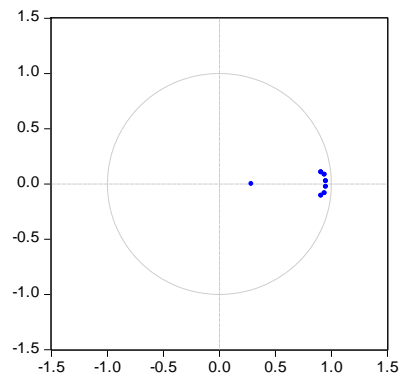

A2: Impulse response functions (IRF) for the international transmission of ECB conventional monetary policy. The country responding to the currency shock is the Czech Republic (SVAR model). Source: own research

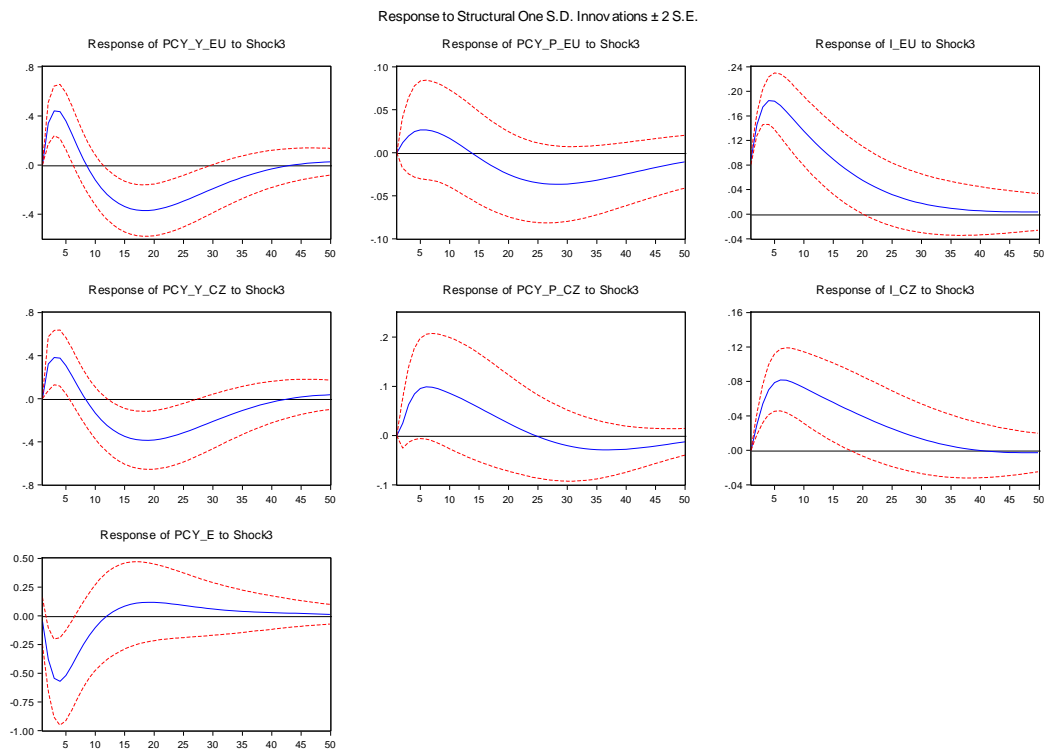

A3: Impulse response functions (IRF) for the international transmission of ECB overall monetary policy. The country responding to the currency shock is the Czech Republic (SVAR model). Source: own research

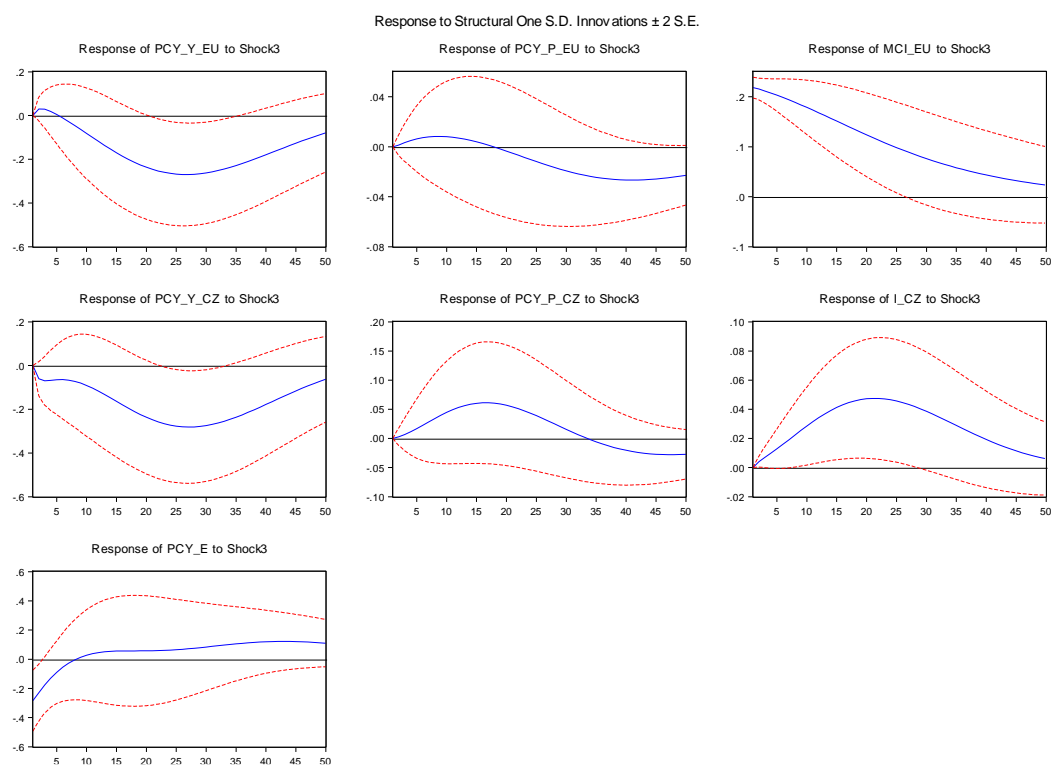

# COMPLEXITY AND PREFERENCES IN THE SERVICE FACILITY OFFER IN THE SLOVAK BUSINESS ENVIRONMENT

*Paula Kamodyová, Marek Potkány*

## **Abstract**

A new management approach – Facility management that manages auxiliary and service business processes to gain more time for core business, cost savings and many other benefits, is the potential for efficiency-based management style. This management can also be ensured through the use of the services of external companies offering facility services within their product portfolio. This is one of the reasons why we focus more closely on the form of providing facility management based on outsourcing principles. The aim of the article is to present the complexity and preferences in the offer of facility service's product portfolio based on a survey of these service providers in the Slovak business environment. In the research of the dissertation thesis "Perspectives of Facility Management in small and medium-sized enterprises", we managed to verify the hypotheses that deal with the complexity of the portfolio of offered facility services, the length of activity of companies in the market and the preference of a certain response. As part of our research, we have been able to verify the hypothesis that most facility service providers in the Slovak business environment offer less than 6 types of services in the context of the complexity of their portfolio, most facility service providers have been offering their service portfolio for more than 10 years on the market and the facility service provider prefers some potential benefit of facility management as an important option.

*Keywords: facility management, providers, processes, changes, small and medium size enterprises*

## **1 INTRODUCTION**

From the terminological point of view, facility management is considered a relatively new section, which we can know it in a simpler form from the prehistoric times such as: preparing food, cleaning the dwelling, transporting the necessary life objects or helping each other through various activities. The term facility management as we currently know it is dated to the 1970s in the United States, where building designers and their owners began to realize a mismatch between the original ideas and the changing needs of users during the operation of buildings. From the above mentioned facts arise the necessity of solution in a professional way arose, through the use of facility management.

The aim of the article is to present the complexity and preferences in the offer of facility service's product portfolio based on a survey of these service providers in the Slovak business environment.

Currently available research studies in this area deal with many areas linked to the concept of facility management, in particular its use on the basis of outsourcing principles. It goes for example about developing and empirical testing a structural equation model for analysing the risk factors associated with outsourcing equipment services and its impact on business performance (Ikediashi, Ogunlana & Udo, 2013). Bröchner (2017) deal with identifying a method that is suitable for measuring direct productivity in relation to facility management providers, on the other hand Roper (2017) evaluates the progress in managing auxiliary and service processes in the company. It is also possible to get acquainted with the solutions of the category's structure in the outsourcing relations between clients and service providers in

connection with facility management (Leung Lok & Baldry, 2016). In Shin, Lee and Park's study (2018) suggest an appropriate process model for the management of office building equipment, which includes 6 sequential processes: equipment identification, tenant properties, elaboration of facility management plan, operation and maintenance, new information collection, performance analysis and performance of ancillary activities. The aim of the model is to reconcile the objectives of facility management with profit growth. Or authors Choi, Kang, Kim (2011) present a method to define the spatial hierarchy of facilities to support managing urban renewal mega projects at the program level.

Based on these facts, the topic of providing facility management through external companies is the subject of our further research within the dissertation.

## **2 FACILITY MANAGEMENT AS PART OF ENTERPRISES**

The point of facility management in its initial understanding of this instrument 's substance is to ensure activities related to the management of buildings or premises. However, in a comprehensive perception of management, facility management can be understood as the coordination of ancillary activities supporting the core business" (Potkány, 2015). While "supporting activities" means those processes that are not related to the main business activity of the company "(Potkány, 2015).

Among the most commonly used facility management definitions is the IFMA definition. This international organization defines "facility management as a method of reconciling workers, work activities and working environments within organizations, incorporating the principles of business administration, architecture, humanities and technical sciences" (Somorová, 2017).

The basic definition of management supporting business process can be considered as STN EN 15221 by the law, which defines facility management as "integrating processes within an organization to provide and develop agreed services that support and enhance the effectiveness of its core operations and organization". At the same time, the standard ISO 41000 - Facility Management has been officially issued since 3.3.2018, which replaces the first two parts of the STN EN 15221 technical standard. This is the completion of the first phase of the global ISO 41000 standard. Parts 3 to 7 of STN EN 15221 are still valid. The essential information is that ISO 41000 is fully based on STN EN 15221. The standard culminates in the twenty-year effort of facility managers in the Slovak Republic to promote the division into enterprises. Until now, facility management has often been ignored by TOP management in many companies or in most cases considered as a technical asset management department. Therefore, ISO 41000 elevates facility management to the level of an enterprise management system (Slovenská asociácia Facility managementu, 2018).

The foregoing definition of the international definition of IFMA implies that facility management is concentrated in 3 core areas:

- a) areas relating to workers, i.e. human resources and sociological aspects (tracking and analyzing the needs of core business personnel), facility management staff skills);
- b) areas of work, i.e. performance and financing (know-how of the main activities and their links);
- c) working environment areas, i.e. architecture and engineering (monitoring and analysis of workplace needs, optimal layouts and links, technical background). (Somorová, 2017)



Fig. 1 – Core areas of Facility management. Source: Axispointe (2014)

On the one hand, a large number of authors in literary sources focus on categorizing the main activities in order to maximize their efficiency. On the other hand, it is necessary to realize that the strategic objective of facility management is to ensure the effective functioning of support activities in the company. From this we can conclude that it is necessary to have defined areas of support activities.

The categorization of the facility management area, in which the application is possible, is dealt with in the standard STN EN 15221 Facility Management, which divides the support processes into 2 basic groups:

Tab. 1 – Categorization of the facility management. Source: Kuda, Beránková & Soukup (2012)

1. Space and infrastructure:	2. People and organization:
<b>a. Accommodation and space services:</b> strategic planning, space man., proposals, construction of future premises, renovation or rebuilding of premises, rental of premises, administration and maintenance of buildings,	<b>a. Health, safety and protection:</b> medical services, security management, access systems, identification cards, disaster scenario and recovery plan, fire protection and prevention,
<b>b. Workplace:</b> design and ergonomics of the workplace, the selection of furniture, equipment and machines, moving, replacement of the furniture, interior and exterior equipment, marking, decoration, space division,	<b>b. Care for object's users:</b> reception and secretarial services, help desk services, food and vending machines, organization of conferences and special events, provision of workwear and aids,
<b>c. Technical infrastructure:</b> energies management, environmental management, management of operating systems and maintenance of building, waste management,	<b>c. ICT:</b> operation of data and telecommunication networks, IT security, protection, maintenance, IT, telecom., connections and interconnection, data center management, hosting, server operation, using the GPS system,
<b>d. Cleaning:</b> hygiene services, cleaning of the workplace, machines an space, buildings, windows, other equipment, winter and summer maintenance of the external environment,	<b>d. Company's in-house logistics:</b> internal and courier service, document management and archiving, transportation and storage systems, travel services and car park management, reprographic services,
<b>e. Other space and infrastructure:</b> rental of measurement and special equipment, interior work with special tools.	<b>e. Other people and organization:</b> accounting, audits and financial reports, human resource management, marketing, advertising, legal services, contract management, project management, quality management.

In order for businesses to coordinate the management of ancillary and serving business processes as efficiently as possible, they begin to use or use different forms of access to the coordinated management of ancillary and serving business processes, which are variable and can be implemented in the company as follows:

- 1) creation and integration of the facility management unit into the organizational structure of the organization - insourcing (use of own resources - staff for its / their provision);



- 2) external forms - using the principles of outsourcing (use of resources and services of an external organization for its provision);
- 3) mixed form of the above-mentioned insourcing and outsourcing. (Somorová, 2006)

With business development and emerging competition, it is not easy to monitor all business processes in a business and keep up with every activity that has no direct impact on business. For this reason, the second type of access assurance is increasingly used, namely relocation (transfer, crowding out) of one or more activities that the company has so far carried out solely on its own direction to an external company from which the results of activities (products and services) are purchased - outsourcing. (Dvořáček & Tyll, 2010)

### 3 METHODOLOGY

The aim of the article is to present the complexity and preferences in the offer of facility service's product portfolio based on a survey of these service providers in the Slovak business environment. To achieve this goal, we used a Google Forms questionnaire. The first part of the questionnaire informs about the basic data of companies as the size of the enterprise in terms of the number of employees. These were the following types of enterprises, which are classified by Commission Recommendation 2003/361 / EC of 6 May 2003 as follows:

Tab. 2 – Categorization of the facility management. Source: UNMS SR (2003)

Category of business	Staff headcount	Annual turnover	Balance sheet total
Medium-sized enterprises	< 250	≤ 50 mil. € (40 mil. € in year 1996)	≤ 43 mil. € (27 mil. € in year 1996)
Small enterprises	< 50	≤ 10 mil. € (7 mil. € in year 1996)	≤ 10 mil. € (5 mil. € in year 1996)
Micro enterprises	< 10	≤ 2 mil. € (previously undefined)	≤ 2 mil. € (previously undefined)

UNMS SR (2003) includes the numbers of full-time, part-time and seasonal workers, including the following types of workers: employees, persons working for the enterprise, being subordinate to it and under national law Regulations are considered to be employees, owners - managers, partners who participate in regular activities in the company and benefit from it. Apprentices or students participating in vocational training on the basis of apprenticeship or vocational training contracts shall not be counted as staff. Similarly, employees on maternity or parental leave are not included. The number of workers is expressed in annual work units. Anyone who has worked full-time in or on behalf of an undertaking throughout the reference year shall be considered as one unit. Those who worked part-time, seasonal workers and those who did not work all year are considered parts of one unit. We were also interested in the basic data on the company such as region of operation, ownership (capital structure) and the length of business activity on the market.

The second part of the questionnaire focuses on the complexity of service offerings, the aspect of assessing the potential benefits of using the facility services provided, assessing the interest in terms of increasing the customer's number, the possibility of expanding the portfolio of services in individual core areas of facility management.

In view of the main objective of the present article, we have formulated the following hypotheses regarding companies offering portfolio of facility services in the Slovak Republic:

*1) We assume that most facility services providers in the Slovak business environment offer less than 6 types of services in the context of the complexity of their portfolio.*

2) We assume that most facility service providers have been offering their service portfolio for more than 10 years on the market.

At the same time, we focus on a specific question from the questionnaire survey on the potential benefits of providing facility management's services: „In the context of your service offer, which of the potential benefits to your customers do you consider important?“, where we verify the third hypothesis:

*H<sub>0</sub>: The facility service provider prefers some potential benefit of facility management as an important option*

*H<sub>1</sub>: Facility service provider does not prefer some potential benefit of facility management to be important of the offered options.*

When we find out that the facility service provider prefers a certain potential benefit of facility management as an important from offered option, we determine the most preferred response from the sample. In order to achieve the set goal and subsequently verify the set hypotheses, it is necessary to proceed from appropriately selected statistical tests in the SPSS statistical program environment as:

- 1) A binomial test that claims that the proportion of a certain value of a variable in the population is equal to the specified constant. The test therefore answers the question whether, on the basis of the sample, it can be argued that the proportion in the population is equal to a certain number, resp. other share in the file (or it is larger or smaller than the entered number). If the p-value is lower than the selected significance level, the null hypothesis is rejected and the alternative is accepted. This means that the difference between the entered constant and the fraction calculated from the sample is too large to be the result of random sampling and is therefore statistically significant. If the p-value is equal to or higher than the selected significance level, the null hypothesis cannot be rejected. This means that the difference between the given constant and the fraction calculated from the sample can only be the result of random sampling, and is therefore not statistically significant” (Kozáková, 2008);
- 2) To verify hypotheses no. 3, we used the non-parametric Friedman test. „The test verifies the median agreement for k (k > 2) variables with the same categories (e.g. respondents' answers to questions with the same scoring scale), i.e. for k dependent selections with the same range n. The null hypothesis assumes that all selections are from a single population, the distribution function is the same. We assign the response codes obtained from the respondent to the values found for the variables. We assume that if there is no difference between the selections and the null hypothesis applies, the order for each unit and the order for each variable will be randomly distributed” (Kašćáková & Nedelová, 2014).

We verified all established and verified hypotheses at the significance level of 0.1. The use of the above-mentioned statistical tests in the background of statistical program SPSS enables to improve the quality of the results and allows analysing the relationships and assumptions that are predefined.

## **4 RESULTS**

In the research, which is part of the dissertation called "Perspectives of Facility Management in small and medium-sized enterprises", we focused not only on the small and medium-sized enterprises, which use, do not use or not are interested in using facility management, but also

for external companies that offer individual types of facility services within their own portfolio in the Slovak business environment.

We also state that we did not verify the representativeness of the sample by testing selected criteria. It can be stated with certainty that according to the ŠÚSR reports it is not possible to determine the basic population level, because there is no overall database of enterprises providing facility services within the available statistical databases. Enterprises offering facility services are associated in the Slovak Association of Facility Management - SAFM, which involved 100 companies. The SAFM database was used for addressing the companies. Only 52 randomly selected enterprises providing support and service business processes in the Slovak Republic have participated in the questionnaire research. Due to the basic file of companies, the sample of selected enterprises analysed is sufficient.

Overall, we randomly addressed 52 micro, small and medium-sized enterprises, where micro-enterprises (1-9 employees) accounted for 38.5%, small enterprises (10-49 employees) 34.6% and medium-sized enterprises (50-249 employees) accounted for the remaining 26.9%. Another important figure is the percentage of the capital structure, ownership in individual types of micro, small and medium-sized enterprises. For better clarity, see figure 2.

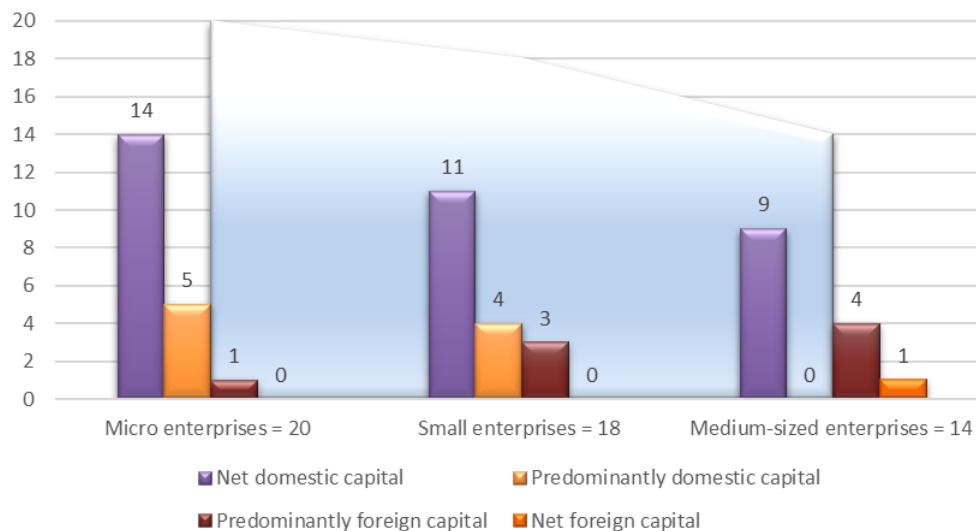

Fig. 2 – Percentage of enterprises of capital structures. Source: own research

Question no. 2, we focused on the regions of enterprises' operation in the Slovak Republic, which we found the following descending order shown in figure 3.

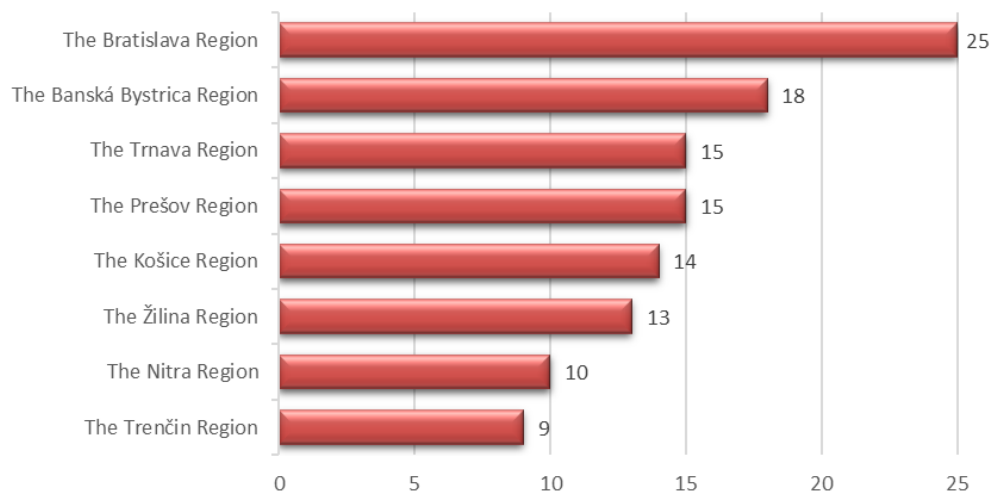

Fig. 3 – Descending order of enterprise's operation in the regions. Source: own research

The binomial test ( $p$ -value = 0.000) confirmed hypothesis no. 1, where we reject  $H_0$  and thus accept the assumption that most facility service providers in the Slovak business background offer less than 6 types of facility services. Within the complexity of the offer for the most frequent services in the companies' portfolio were included technical management and maintenance, cleaning, cleaning including special and external, HVAC (Heating, Ventilating, Air-conditioning), energy management and exterior constructions, repair and regular service. This can be attributed to the fact that, in the Slovak Republic, facility management was only directly linked to the management of the building or the cleaning, which results from the historical development of the facility management background.

Hypothesis with no. 2 was also verified through a binomial test with a resulting  $p$ -value of 0,106, which means that we do not reject  $H_0$  and therefore do not accept that most facility service providers have been offering their service portfolio for more than 10 years on the market. The result itself is striking, since in 2019 the Slovak Association of Facility Management in Slovakia celebrated 10 years of existence, which at the same time propagates the awareness, visibility of the branch among the general public and leads conferences in various areas on facility management. We can attribute this fact to that the facility management department is only in its infancy and is still developing. Until today, there are a large number of companies that do not know facility management as a support to business and business processes nor its benefits from the use that flow. Another reason is the probability that companies that are not on the market for a long time but are managing their activities in a modern way, are taking advantage of facility management.

We were also interested in question, which of the potential customer benefits, businesses consider facility services consider it important. Companies had a choice of options as more time to deal with the core business, increase company performance and profit, transfer risk to service providers, save costs, improve the quality of the activities performed, and gain expertise from outsourced activities. Based on the statistical output, we can test the hypothesis of difference of responses in Table no. 3. Thus, we further assumed that the facility service provider interviewed preferred one of the answers. The determination from the most to the least preferred answers of the questioned enterprises can be realized by means of McNemar test.

Tab. 3 – Potential customer benefits. Source: own research

<b>Question 6</b> <b>Within the range of your services, which of the potential benefits for your customers do you consider important?</b>	<b>n</b>	<b>%</b>	<b>Average rank</b>
<i>Save costs</i>	42	26.9	5.33
<i>More time to deal with the core business</i>	35	22.4	4.86
<i>Improve the quality of the performed activities</i>	31	19.9	4.59
<i>Increase company performance and profit</i>	22	14.1	3.98
<i>Transfer risk to service providers</i>	12	9.0	3.44
<i>Gain expertise from outsourced activities</i>	10	6.4	3.17
<i>Other</i>	2	1.3	2.63
<b>∑ Sum of answers</b>	<b>156</b>	<b>100</b>	

(Friedman test,  $p$ -value = 0,000)

Using the McNemar test, we have found that the 3 most important potential benefits that should influence customer opinion using outsourcing principles for facility management, are cost savings, more time to deal with the core business, and improve the quality of the performed activities. Other benefits are seen by enterprises providing facility management emergency services as less significant.

## 5 CONCLUSION

The business background is undergoing a number of different changes that encourage micro, small and medium-sized enterprises to adapt and create a favourable competitive background. One of them is the use of a new managerial approach, which manages auxiliary and service business processes a.k.a facility management with the aim of gaining time to solve the main business activity, improve the quality of business processes, and increase their performance and other benefits.

Outsourcing is an essential part of ensuring the implementation form of access to the coordinated management of auxiliary and service business processes. This external form is based on outsourcing of support processes so far provided by own resources. In addition to communicating with the company's internal employees, the external facility manager is mainly responsible for the delivery, scope and quality of the required services, and is also required to prepare the required reports to monitor the effectiveness and fulfilment of contractual conditions. (Vyskočil, 2009)

The decision to apply this principle is often influenced by several factors of complexity (e.g. company culture, company location, settlement structure, company know-how, and experience in the field). Available research (Chotipanich, 2004, Coots 2008, Vetráková, Potkány & Hitka, 2013) shows that facility management can create the potential to save and optimize operating costs, with support for increasing employee performance leading to increased business profitability.

Based on the knowledge gained through research and verification of established hypotheses, we found that the vast majority of the research was carried out by micro-enterprises with 1-9 employees in the Bratislava, Trnava and Banská Bystrica regions with ownership/capital structure - net domestic capital that are on the market more than 10 years. Based on our findings, it is possible to state that the assumptions set by us were confirmed: 1) We assume that most facility services providers in the Slovak business environment offer less than 6 types of services in the context of the complexity of their portfolio. 2) We assume that most facility service providers have been offering their service portfolio for more than 10 years on the market. 3) The facility service provider prefers some potential benefit of facility management as an important option. Based on the McNemar test we identified the 3 most important potential benefits, which are at the same level of significance: 1) Save costs; 2) More time to deal with the core business; 3) Improve the quality of the performed activities.

The results obtained through statistical tests will be used in the analytical part of the dissertation "Perspectives of Facility Management in small and medium-sized enterprises", which concerns companies providing individual types of facility services.

### References

- Axispointe. (2014). *Solutions for Facility Managers*. Available at: [https://www.axispointe.com/axisfm/fm\\_diff\\_one.php](https://www.axispointe.com/axisfm/fm_diff_one.php)
- Bröchner, J. (2017). Measuring the productivity of facilities management. *Journal of Facilities Management*, 15(3), 285-301. doi: 10.1108/JFM-04-2016-0013.
- Cotts, D. G., Roper, K. O., & Payant, R. P. (2008). *The Facility management handbook*. USA: Amacom.
- Dvořáček, J., & Tyll, L. (2010). *Outsourcing a offshoring podnikatelských činností*. Praha: C. H. Beck.

- Choi, H.M., Kang, K.H., Kim, J.H., & Kim, J.J. (2011). A study on classification of facility elements for supporting project definition of urban renewal mega project using morphological box method. *Proceedings of the 28th ISARC*, 449-454. doi: 10.22260/ISARC2011/0082
- Chotipanish, S. (2004). Positioning facility management. *Facilities*, 22(13/14), 364-372. doi: 10.1108/02632770410563086
- Ikedashi, D., Ogunlana, S., Udo, G. (2013). Structural equation model for analysing critical risks associated with facilities management outsourcing and its impact on firm performance. *Journal of Facility Management*, 11(4), 323-338. doi: 10.1108/JFM-10-2012-0046.
- Kaščáková, A., & Nedelová, G. (2014). Dotazníkový prieskum II. – overovanie hypotéz. *Forum Statisticum Slovacum*, 10(3), 109-114. Retrieved from <http://ssds.sk/casopis/archiv/2014/fss0314.pdf>
- Kozáková, D. (2008). *Štatistické spracovanie výskumov*. Retrieved from [www.educano.sk/vyskumy.php](http://www.educano.sk/vyskumy.php).
- Kuda, F., Beránková, E., & Soukup, P. (2012). *Facility management v kostce: pro profesionály i laiky*. Olomouc: Form Solution.
- Leung Lok, L., & Baldry, D. (2017). Demand and supply of FM outsourcing services. *Journal of Facility Management*, 24(3), 221-248. doi: 10.1108/JFM-07-2015-0024
- Potkány, M. (2015). *Perspektívy využitia facility managementu pre zvyšovanie konkurencieschopnosti lesníckych a drevárskych podnikov*. Zvolen: Technická univerzita vo Zvolene.
- Roper, K. (2017). Facility management maturity and research. *Journal of Facility Management*, 15(3), 235-243. doi: 10.1108/JFM-04-2016-0011
- Shin, H., Lee, HS, Park, M., & Lee, JG. (2018). Facility Management Process of an Office Bulding. *Journal of Infrastructure systems*, 24(3), 149-154. doi: 10.1061/(ASCE)IS.1943-555X.0000436
- Slovenská asociácia Facility managementu. (2018). *SAFM Guide 2018*. Bratislava: IC Consulting.
- Somorová, V. (2017). *Facility management v stavebníctve*. Bratislava: Slovenská technická univerzita v Bratislave.
- Somorová, V. (2006). *Facility management metóda efektívneho spravovania budov*. Bratislava: STU Bratislava.
- UNMS SR. (2003). *Definícia MSP*. Retrieved from [http://www.unms.sk/?definicia\\_MSP](http://www.unms.sk/?definicia_MSP)
- Vetráková, M., Potkány, M., Hitka, M. (2013). Outsourcing of facility management. *E&M Economics and Management*, 16(1), 80-90. Retrieved from <http://www.ekonomie-management.cz/en/archiv/search/detail/873-/>
- Vyskočil, V.K. (2009). *Facility management processes and support activities management*. Praha: Professional Publishing.

## **Contact information**

### **Ing. Paula Kamodyová**

Matej Bel University in Banská Bystrica, Faculty of Economics

Tajovského 10, 97590, Banská Bystrica, Slovak Republic

E-mail: paula.kamodyova@gmail.com

ORCID: 0000-0003-3444-9714

### **doc. Ing. Marek Potkány, PhD.**

Technical University in Zvolen, Faculty of Wood Sciences and Technology

T. G. Masaryka 24, 96001, Zvolen, Slovak Republic

E-mail: potkany@tuzvo.sk

ORCID: 0000-0002-7477-6157

doi: 10.7441/dokbat.2019.051

# EVALUATION OF BUSINESS CULTURE IN THE SELECTED COMPANY

*Radka Kataniková, Pavol Grman, Petronela Švikruhová*

## **Abstract**

The main aim of the paper is to evaluate selected elements of corporate culture in the selected company. For this purpose, we selected an international information society based in Bratislava. This section explains the meaning and substance of corporate culture as well as basic definitions and characteristics of healthy, unhealthy, strong and weak corporate culture. The practical part is focused on the evaluation of the corporate culture in the selected company. In the introduction general characteristics of the company are recorded. One of the partial goals is the evaluation of the questionnaire survey and conducting a controlled interview with the manager in the selected company. Another partial goal is statistical testing of hypotheses, which is realized using the  $\chi^2$  test. In the concluding part are summarized key findings and suggestions for the practice and purposes optimization of corporate culture in selected company. Based on the research, the corporate culture in the surveyed enterprise carries elements of strong culture, since: the values of the company are generally deeply rooted among employees and managers. A proactive approach to implementing innovative solutions is also a hallmark of a healthy corporate culture. There is also a visible remuneration system in company and management is interested in the welfare of all stakeholders – i.e. j.: customers, employees, shareholders and others. The company has many rooted values, standards and traditions. Despite the fact that the corporate culture appears to be prosperous now, strong and healthy, caution should be exercised in the following risk areas: communication, business management and the working environment. Based on the research conducted and the evaluation of results, we recommend using methods such as mentoring and coaching, especially for executives such as first-line and second-line managers. For even greater employee satisfaction, we recommend extending the benefits package or a more flexible reward system. At the end of the paper, we offer other tools for strengthening the corporate culture in the selected company.

**Keywords:** *corporate culture, employees, questionnaire, working environment, management, managers, human resources*

## **1 INTRODUCTION**

The topic of organizational culture is at the forefront of business practice even in the conditions of the Slovak Republic, especially after a period of socio-political changes, starting in 1990. Nowadays, many multi-national as well as Slovak companies are starting to deal with this topic more intensively in order to build the business and highlight the interpersonal, ethical, cultural, and architectural attributes of the business company.

The aim of the paper is to evaluate the corporate culture in the selected company. We focus mainly on the evaluation of the following aspects: working environment, communication and relations, business management, corporate values and mission, etc. The methods that will be used in the research are discussed in the methodology part, the following methods: the guided interview method, the questionnaire survey method and the Chi square test method. Using the latter method, we will test the following scientific hypotheses:

*1) The evaluation of working relationships in the examined company depends on the sex of the employee.*



- 2) *Knowledge of the company's mission depends on the length of contract of the employee.*
- 3) *The employee's relationship with the company depends on the job position he / she holds.*
- 4) *Satisfaction with the working environment depends on the age of the employee.*

The evaluation of corporate culture will be carried out in an international company for information technology. This company is described in detail at the end of the theoretical part.

This company has been chosen for several reasons. We consider the organization very attractive for economy graduates, such as ours and so we decided to analyse it more closely. Another reason is that we assumed that the selected company will indeed have a strong corporate culture which in many cases could prove to be a problem if this culture would grow into an unhealthy organizational culture. Therefore, we wanted to verify this hypothesis practically through questionnaire survey designed for company employees. At the beginning of this paper we have one main and four secondary goals: to characterize the company and its culture, conduct a questionnaire survey and analyse its results, statistically verify logically tentative hypotheses and last but not least summarize the results, findings and suggestions for practice with the intention of enhancing the strengths of corporate culture.

## **2 THEORETICAL BACKGROUND**

Corporate (organizational) culture carries a normative meaning because it determines the expected behaviour of employees of the company. It is strong organizational culture when the behavioural criteria are clear and unambiguous and accepted by the majority of all members of the organization. (Ubrežiová, 2018)

Šajbidorová (2005) draws attention to the fact that a strong organizational culture has its drawbacks and pitfalls. It is for example: isolation tendencies, too much fixation on traditional patterns, resistance to change and new ideas, but also a collective effort of employees to avoid criticism and conflict. According to Lušňáková (2012), corporate culture represents a collective belief, system of values and processes that ensure the object's uniqueness. Each company and organization have a set of goals, attitudes and values that define its business and non-business activities. Šajbidorová (2006) writes that the corporate culture provides individuals with the opportunity to justify their behaviour within the enterprise according to corporate values. The author points out that managers have the opportunity to use the corporate culture to support the type of employee behaviour that is desired. Savov (2015) claims that the corporate culture is also influenced by the company's vision. He defines the vision as an attractive image of the future. The vision depicts the goal of how far a business can develop.

As Šajbidorová (2003) proves, for a proper understanding of the functioning of organizational culture it is necessary to explain its individual levels that make it up. Organizational culture consists of three levels. The first level is the surface (symbolic) level which consists of a system of symbols such as: organizational structure, clothing, workspace, logo, etc. These symbols can be perceived by one's senses. The second level is a system of values, principles, rules and standards. This system of aspects is manifested e.g. in loyalty to the business, in customer relations, etc. The third level is the core of the corporate culture. It is formed by relations to the environment, time, reality, truth and so on. As Joniaková (2016) states, organizational culture is a very broad multidimensional expression used in management theory in the post-war period, when the cultural relativity of certain Japanese management procedures begun to be considered. Veber (2014) claims that in the current socio-economic environment for which, in particular the existence of an enormous number of business entities is particularly significant, create a hyper-competitive environment where supply dominates over demand, it would undoubtedly

be a gamble if a situation arose in which companies were no longer interested in their own perception by the employees, business partners as well as competitors.

Šimo and Mura (2015) state that culture is formed in parallel with the development of the company. They agree that organizational culture is influenced by managers, employers, employees. They refer to the culture of the enterprise as a formula of basic and decisive ideas which the group has taken over or has also developed. They also state that the company culture is dynamic, changing, evolving and shaping. It is affected by two environments: external environment - e.g. national culture, mentality nation and so on, and internal environment - e.g. company values, professional approach to perform tasks and others. The authors state that organizational culture is a qualitative quantity that cannot be expressed or quantified accurately. It is a product of past activities and at the same time it is limiting element of the company's future activities.

According to a Deloitte survey, 94% of executives and 88% of employees believe that a distinctive corporate culture is important to business success. The company survey also found that there is a strong correlation between employees who say they feel happy at work and those who say their company has a strong culture. Culture IQ research has shown that overall employee quality assessment is 20% higher in companies that show a strong culture. (Kohll, 2019)

Lim (2019) states that Harvard Business Review identified six important aspects of successful corporate cultures in 2015: vision, values, established practices, people, company stories and the working environment. A Deloitte study states that 87% of organizations consider creating corporate culture as one of their main challenges (Forsey, 2018). Horný (2016) states that the reason as to why address the culture and, in a narrower sense, corporate culture today is that corporate culture has a significant impact on corporate image and, above all, because it is a prerequisite framework on which corporate identity is based.

## **2.1 Characteristics of healthy corporate culture**

Managers and management spend a lot of time communicating and strengthening values of the company. Company values are generally deeply rooted among workers and managers. The organization carefully selects new employees in order to ensure that future employees will accept the company's values. Company managers are introducing new strategies to achieve better performance, and employees are encouraged to take risks, experiment and innovate to meet the interests of stakeholders (all persons and institutions that have a particular organization). A proactive approach to the implementation of innovative solutions is also a common feature of a healthy organizational culture. In companies with a healthy organizational culture, there is a visible remuneration system and management is interested in the well-being of all stakeholders as well as customers, employees, shareholders, etc.

## **2.2 Characteristics of unhealthy corporate culture**

There are many subcultures in a company where there is an unhealthy organizational culture inside the organization. The company has few strong rooted traditions, as well as very few values and standards that are generally shared between employees and managers. In these companies there is little coherence between the strategic units of the organization. Risks include poor employee loyalty to the organization's vision and strategy. Employees have great resistance to change - experiments and attempts to change status are not supported. (Mallya, 2007)

### **2.3 Characteristics of the selected company**

The company is a pioneer in many areas of the computer industry, from the mainframe of computers to nanotechnology. An international information technology company brings comprehensive, innovative and professional IT solutions and services to its customers around the world. The company is one of the largest IT companies. It provides clients in more than 170 countries with a broad portfolio of innovative IT products and services, while constantly expanding its geographic coverage. The company's mission is to help customers reduce costs and increase their competitiveness in the market by using integrated, flexible and efficient solutions.

The company has been active in Slovakia since 1990. The subsidiary (also known as: International Services Centre, International Service Centre, or Shared Services Centre) was established in 2003 in Bratislava. There are two branches in Slovakia in Banská Bystrica and Košice. International Centres in Slovakia provide their services to cover individual business operations and processes to internal and external clients in more than 70 countries of the world. Currently, the International Services Centre in Bratislava covers approximately 30 operations in various business areas.

## **3 AIM AND METHODOLOGY**

The research was focused on the evaluation of the corporate culture in the selected company. For this purpose, an international information technology company based in Bratislava was selected. This company was chosen because it is an international company with rich history and is significant in the information technology market. Because of this we assumed that the organizational culture in this business will be reflected at a high level and that the results obtained by this research can be incentives for other companies operating on the market for a much shorter period. The questionnaire survey was conducted from 8<sup>th</sup> to 15<sup>th</sup> March 2019, while conducting a series of interviews with a consultant who is an employee of the surveyed company, between January 2019 and May 2019.

The information and data mentioned in this paper have been obtained from both domestic and foreign literature on corporate culture, as well as from articles published on the web pages on the subject under consideration. Furthermore, we used background materials and information provided by the consultant. We also drew on the company's official website where the published information is freely available. The interviews conducted with a consultant working in the company under review helped us significantly.

Managed interviews with the consultant from company were based on consultations and on the basis of targeted questions. During the interview we talked through his view of preferences and weaknesses of the company, about possible solutions to problems at his discretion and also about us and interested in his opinion on the forecast of business development. The consultant also explained a number of peculiarities concerning the company. He spoke about business traditions, values, visions, but also about business systems, the corporate structure, the process of employee selection, etc. Conducted interviews with him helped us create a clearer view of corporate culture in the company.

Finally, we used the information from the implemented anonymous questionnaire survey. The aim was to obtain information on the perception of corporate culture in an international information technology company by its employees.

A total of 73 respondents in various positions responded to the questionnaire. Twenty-two questions are divided into two parts. The first 5 questions can be identified as identification questions. They relate to gender, age, education, job position and length of service. The

remaining questions were created to get a closer look at organizational culture directly from the company's employees.

The other questions were aimed on:

- a) reasons, why the employees have chosen that company,
- b) identify the most prominent business features within culture,
- c) to determine the opinion of employees within the company's ability to create a competitive advantage,
- d) to determine employees' opinion about whether corporate culture is important to the enterprise,
- e) to explore how well employees, know the mission of the business,
- f) to determine to what extent corporate values are applied in practice,
- g) a number of questions were targeted at the working environment and communication,
- h) we were also interested in implementing new employees,
- i) a number of questions were directed to the establishment of work relationships,
- j) we were interested in managers' access to ordinary employees,
- k) and we were also wondering how to solve workplace problems.

Some questions were open, so respondents were free to write their opinion. And the remaining questions were in the form of an offer of possible answers - where they could mark one or more answers at their discretion. By creating this questionnaire, we have focused on the following aspects of corporate culture: working environment, communication and relationships, company management, values and mission of the company.

#### **Methods used:**

**Managed interview method** - with a consultant working in the selected company who gave us helpful information about organizational culture in this way in the company. **Questionnaire survey method** - the frequency of use of this method has increased in particular through the expansion of information technology. The success of this method is conditioned by correctly worded questions, willingness of respondents as well as truthful answers. This method is used mainly for the detection of data of a qualitative nature, but occasionally also when collecting factual data of quantitative nature. Responses processed in EXCEL. We also expressed the data graphically in the form of graphs and tables with absolute or relative values. In addition to the methods mentioned above, we also used **contention tables** in this work and the **Chi square test method ( $\chi^2$  test)**.

#### **Chi square test method ( $\chi^2$ test)**

For the purposes of testing statistical hypotheses, we chose the  $\chi^2$  square contingency test. This test should be used when quantitative quantities are compared. It is used in determining whether the frequencies in each category are randomly, naturally or whether the distribution of the frequencies in each category has been triggered by a particular incentive. Based on this test, the frequency of occurrence, as well as the dependence between variables, are tested and determined.

For all six hypothesis tests, the same procedure was followed:

- 1) We have determined a dependent and independent variable;
- 2) We formulated hypotheses H0 and H1 as follows:

- a) H0: There is no statistically significant link;
- b) H1: There is a statistically significant association;

3) We compiled pivot tables for observed (E<sub>i</sub>) and expected (T<sub>i</sub>) frequencies.

We have calculated the expected frequencies (T<sub>i</sub>) using the following formula:

$$\left( T_i = \frac{\sum \text{relevant column} * \sum \text{relevant line}}{\sum \text{total amount}} \right) \quad (1)$$

4) Next, we calculated the Chi-square value according to the formula:

$$\left( \chi^2 = \sum_{i=1}^m \sum_{j=1}^k \frac{(E_{ij} - T_{ij})^2}{T_{ij}} \right) \quad (2)$$

where: E - empirical abundance; T - theoretical abundance; m - number of rows; k - number of columns; n - total number of measurements;  $\chi^2$  - calculated test criterion - test characteristic (TCH)

5) Using the CHIINV function (the function is used to compare the recorded results to determine if the original hypothesis is valid.), We calculated a table critical value in Excel:  $\chi^2_{tab}$ .

$$\chi^2_{tab} = (\alpha, (m-1)(k-1)) \quad (3)$$

where:  $\chi^2_{tab}$  - tabular (critical) value of  $\chi^2$  distribution at degrees of freedom (M-1) \* (k-1);  $\alpha$  - alpha at the significance level of 0.05

6) We set the conclusion of the findings.

- a) As long as  $\chi^2_{tab} > \chi^2$ , we accept the hypothesis H0 and reject the hypothesis H1.
- b) If  $\chi^2_{tab} < \chi^2$  holds, we accept hypothesis H1 and reject hypothesis H0.

If fact b) occurs, we investigate the strength of dependence by Pearson coefficient:

$$\left( c = \sqrt{\frac{\chi^2}{n + \chi^2}} \right) \quad (4)$$

where: C - Pearson coefficient;  $\chi^2$  - test characteristic; n - number of observations examined

The Pearson coefficient reaches a value in the range <0,1>, applies the rule, that the higher the value is, the higher is the dependency strength between the variables which are investigated.

Scientific hypotheses:

- 1) *The evaluation of working relationships in the examined company depends on the sex of the employee.*
- 2) *Knowledge of the company's mission depends on the length of contract of the employee.*
- 3) *The employee's relationship with the company depends on the job position he / she holds.*
- 4) *Satisfaction with the working environment depends on the age of the employee.*

## 4 THE RESULTS

The aim of the paper is to carry out and evaluate a questionnaire survey in order to evaluate the corporate culture. Interviews with a consultant working for the company on a managerial

position for several years have also helped us to a large extent finish this article in a selected company. The aim of the paper is to evaluate selected elements of corporate culture in the chosen company. This objective was achieved by several methods mentioned in the methodology of work.

**Based on statistical testing of hypotheses, we found the following facts: Evaluation of working relationships in the surveyed company does not depend on the sex of the employee.** We thought that level of evaluation of workplace relationships would depend on the gender of the employee, as men and women have different perceptions. This hypothesis has not been confirmed to us and therefore the perception of relationships differs from case to case. **Knowledge of the company's mission does not depend on the length of contract of employees.** We also assumed that the knowledge of the company's mission depends on how long the employee has worked for the company. We assumed that the longer the employee work for the company, the deeper he knows the basic essentials of the company, which certainly belong to the mission. Based on the research, we could verify that even this statement is not true and that knowledge or ignorance of the mission depends on other factors. **The employee's relationship with the company does not depend on the position he / she holds.** We thought that managers would have a better relationship with the company because they could hold a better paid or other job. This theory has not been confirmed to us in any of the positions. **Satisfaction with the working environment does not depend on the age of the employee.** We thought that the satisfaction with the working environment increases with the age of the employee, as young people have increased demands on comfort, equipment and originality of the working environment, but even this theory has not been confirmed.

**Based on the questionnaire survey we learned the following basic information about corporate culture in the selected company:**

The strong organizational culture and the positive image of the company are evident by the fact that up to 40 (55%) of the employees decided to work for the selected company on the basis of the possibility of career growth. Many people see this possibility as a certain matter or on the contrary, as a work benefit, but we consider it as an element that speaks of a healthy corporate culture, as the company's intention is for its employees to develop and grow.



Fig. 1 – Reasons for employees to work for a selected company. Source: own research

Another positive finding is the fact that respondents consider the three most important elements of the corporate culture: working relationships, company values and employee care, which confirms the judgment we have expressed above. An overview of the most significant elements of corporate culture according to the responses was graphically depicted in Fig. 2.

A healthy and strong corporate culture is a certain asset in competing in the hyper-competitive market. Up to 48 (66%) of employees think that the elements of company culture, which they

have identified as the most significant are decisive in creating a competitive advantage. In the theoretical part of the thesis, we presented the views of several authors who confirm the theory that organizational culture also greatly influences the achievement of company goals. Up to 65 (89%) of responses stated that a strong and healthy corporate culture is important for achieving corporate goals and for employee satisfaction. Other results are also mentioned on the fig.2.

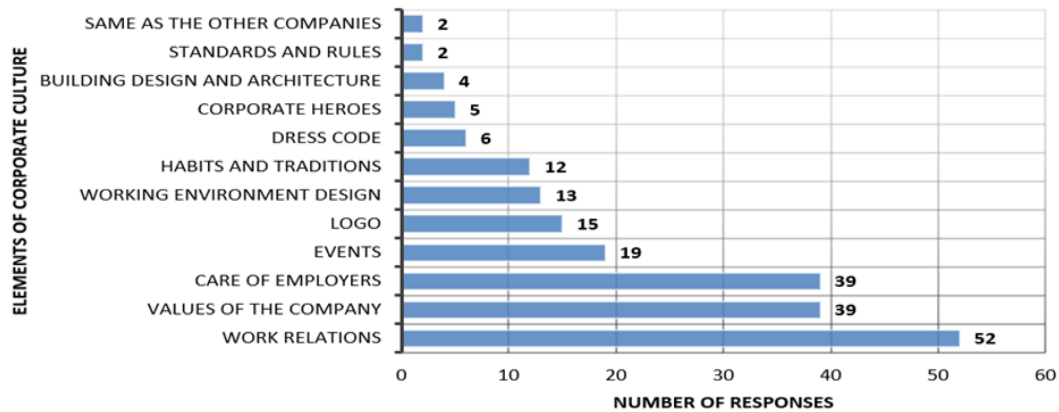

Fig. 2 – The most distinctive elements of corporate culture. Source: own research

Only 45 (62%) of respondents indicated the mission of the surveyed enterprise as valid. In our opinion, the number of correct answers should be higher, as up to 59% of employees work for the company for more than 5 years, which is long enough for employees to be clearly aware of what the mission of the company they work for is.

Fig. 3 shows the answers of the employees - we asked them to what extent the three business values are applied in practice. The employees commented on three business values: Focus on customer and client satisfaction, Making innovation beneficial to the general public, Personal responsibility in all relationships. They had a choice of five options: business value is always applied, often, occasionally, not at all or not. Other results are also mentioned on the figure 3.

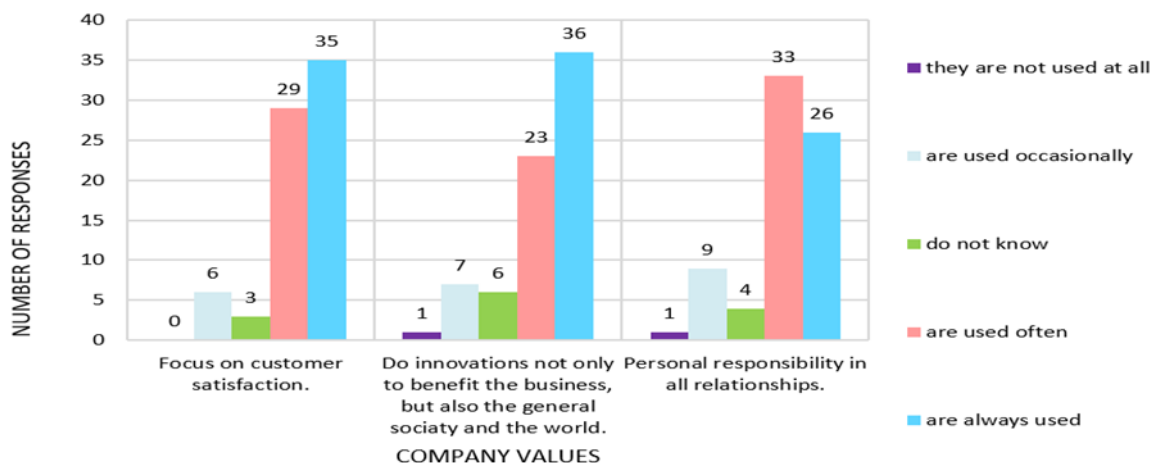

Fig. 3 – Application rate of business values in practice. Source: own research

In particular, we consider that only 13 (18%) of the employees stated that they considered the work space in the surveyed company to be entirely satisfactory and 1 employee stated that he considers the working environment to be inadequate or inappropriate. Employees complained mainly about the lack of greenery or malfunctioning technology.

Only 18 (25%) of them stated that they consider corporate communication to be fully effective and understandable. A key finding is that several employees have expressed dissatisfaction with communication and overall interconnectivity at work level between top management and

between lower-level managers and employees. Responses described the problem as the inability of top managers to understand problems at lower levels of management.

The survey discovered that up to 69 (95%) of employees in the surveyed company, despite all the negative effects retain a positive attitude towards the company itself, creating the best conditions for consolidating and further developing a healthy and strong organizational culture.

In the last question of the questionnaire, we focused on the survey of employee's opinions in the area of rationalization of the current state of corporate culture in the selected company. We received the most observations from employees in the area of organization management, communication issues and in the work environment segment. We consider these areas based on the previous results of the questionnaire replies as very problematic. On the contrary, we consider the strengths of the company to be: employee care, working relationships, non-business activities of the company, as well as high utilization of company values in practice.

## **5 DISCUSSION AND RECOMMENDATION**

Based on the research, we found that the selected company is currently dominated by a healthy and strong corporate culture. This statement is confirmed by our results, which are in line with the definition of healthy corporate culture by Mallya (2017).

Managers and management of company spend a lot of time communicating and strengthening the company values. Company values are generally deeply rooted among workers and managers. The organization carefully selects new staff to ensure that future employees accept the company's values. Company managers are introducing new strategies to achieve better performance, and employees are encouraged to take risks, experiment and innovate to meet the interests of stakeholders (all persons and institutions that have a particular organization). A proactive approach to implementing innovative solutions is also a common feature of a healthy organizational culture. Usually in companies with a healthy corporate culture have a visible remuneration system and management is interested in the well-being of all stakeholders - t. j.: customers, employees, shareholders, etc.

The result of our research was confirmed by a consultant working in the selected company. Managed interviews with the consultant contributed to the research to a large extent. The consultant working in the selected company is the first line manager. He was able to explain in more detail the complex processes that take place in the company. He brought us closer to the corporate culture, especially in terms of various corporate events, customs and traditions. During his visit to the company he pointed out which details in the interior and exterior should be noted how important they are and how these details differentiate the selected company from the competition. Conducted interviews with him helped us to create a clearer view of corporate culture in the company.

Based on the survey and evaluation of the results, as well as after conducting interviews with a consultant working in the selected company, we recommend using methods such as mentoring and coaching, especially for senior executives such as first-line and second-line managers. The aim of these methods is to improve the behaviour and thinking of managers in order to improve their work activities and functions.

To improve the working environment, we recommend placing more green space in the premises and making all the necessary tools and equipment that employees need to perform smoothly and flawlessly. For even greater employee satisfaction, we recommend extending the benefits package or a more flexible reward system.



Another solution we propose is the slow application and strengthening of agile culture. The reason to apply this is its countless advantages. Agile culture adopts a style, approaches and a failure-tolerant community, willing to test hypotheses and adapt to changing market trends and conditions, predicting appropriate conditions for a healthy and strong organizational culture. In order to achieve this goal, we recommend the creation of a brochure on corporate culture or the application of corporate quizzes focused on this issue.

## 6 CONCLUSION

Based on the research results can be said that corporate culture in the surveyed company carries elements of strong culture since: the values of the company are generally deeply rooted among employees and managers. A proactive approach to implementing innovative solutions is also a trademark of a healthy organizational culture. There is also a visible remuneration system in the company and management is interested in the welfare of all stakeholders - customers, employees, shareholders and others. The company has many rooted values, standards and traditions. Despite the fact that corporate culture now appears to be prosperous, strong and healthy, caution should be exercised in the following risk areas: communication, business management and the working environment.

If we would go on, to continue with this research in the future, after a few years - to see the evolution and shift of corporate culture, we would repeat the questionnaire survey for the employees of the department. For directed interviews, we would invite the same manager to find out possible differences in the perception of corporate culture over the years.

If we had the opportunity to resume research, we would be interested in the situation after the implementation of our proposed measures. We would evaluate which of our measures they have put and what benefits they brought. We would also point out new trends in personal management as part of the research and would try to implement them in the company, as the truth remains that the employees of the corporate culture are people – employees

The benefits of this research are in described findings above. Based on a questionnaire survey we were able to analyse the corporate culture. We pointed out the strengths and weaknesses of the company. Based on the results we have also put forward suggestions for practice.

## References

- Forsey, C. (2019). *The Ultimate Guide to Company Culture*. Retrieved from <https://blog.hubspot.com/marketing/company-culture>
- Horný, S. (2016). *Praktická učebnice tvorby firemního stylu*. Praha: Professional publishing.
- Joniaková, Z., Gálik, R., Blštáková, J., & Tarišková, N. (2016). *Riadenie ľudských zdrojov*. Bratislava: Wolters Kluwer.
- Kohll, A. (2018). *How to Build A Positive Company Culture*. Forbes. Retrieved from <https://www.forbes.com/sites/alankohll/2018/08/14/how-to-build-a-positive-company-culture/>
- Lim, S. (2019). *Corporate Culture*. Retrieved from [www.investopedia.com/terms/c/corporate-culture.asp](http://www.investopedia.com/terms/c/corporate-culture.asp)
- Lušňáková, Z. (2012). *Manažment obchodnej firmy*. Nitra: SPU.
- Mallya, T. (2007). *Základy strategického řízení a rozhodování*. Praha: Grada.

- Mura, L., & Šimo, D. (2015). *Manažment organizácií*. Bratislava: Wolters Kluwer.
- Savov, R., & Lančarič, D. (2015). *Strategický manažment*. Nitra: SPU.
- Šajbidorová, M., & Ubrežiová, I. (2003). *Návody na cvičenia z podnikového manažmentu*. Nitra: SPU.
- Šajbidorová, M. (2005). Úroveň podnikovej kultúry a podnikateľskej etiky v organizáciách PPK. Retrieved from [agris.cz/Content/files/main\\_files/59/137537/sajbidorova.pdf](http://agris.cz/Content/files/main_files/59/137537/sajbidorova.pdf)
- Šajbidorová, M. (2006). Vplyv vnútorných determinantov na formovanie podnikovej kultúry. *Medzinárodné vedecké dni 2006*, 4. Retrieved from [https://spu.fem.uniag.sk/mvd2006/zbornik/sekcia4/s4\\_sajbidorova\\_maria\\_180.pdf](https://spu.fem.uniag.sk/mvd2006/zbornik/sekcia4/s4_sajbidorova_maria_180.pdf)
- Ubrežiová, I., Kozáková, J., & Diačiková, A. (2018). *Medzinárodný manažment a podnikanie*. Nitra: SPU.
- Veber, J., Fotr, J., Hášová, J., Malý, M., Mládková, L., Nový, I., a kol. (2014). *Management*. Praha: Management Press.

### Contact information

#### **Ing. Radka Kataniková**

Slovak University of Agriculture in Nitra, Faculty of Economics and Management  
Tr. Andreja Hlinku 2, 94976, Nitra, Slovak Republic  
E-mail: [radka.katanikova@gmail.com](mailto:radka.katanikova@gmail.com)  
ORCID: 0000-0001-8198-3317

#### **Ing. Pavol Grman**

Slovak University of Agriculture in Nitra, Faculty of Economics and Management  
Tr. Andreja Hlinku 2, 94976, Nitra, Slovak Republic  
E-mail: [pavol.steven.grman@gmail.com](mailto:pavol.steven.grman@gmail.com)  
ORCID: 0000-0002-5595-4720

#### **Ing. Petronela Švikruhová, PhD.**

Slovak University of Agriculture in Nitra, Faculty of Economics and Management  
Tr. Andreja Hlinku 2, 94976, Nitra, Slovak Republic  
E-mail: [petronela.svikruhova@gmail.com](mailto:petronela.svikruhova@gmail.com)  
ORCID: 0000-0003-1785-040X

doi: 10.7441/dokbat.2019.052

# MEASUREMENT OF CREATIVE INDUSTRY ENTITIES' PERFORMANCE IN SLOVAKIA

*Mária Kmety Barteková, Monika Raková*

## Abstract

The aim of the paper is to present the results of our analysis focused on the relation between the Global Creativity Index measured for the Slovak Republic and the performance of the creative industry entities. Recently, more and more awareness is given to the creativity. The share of creative industry will be increasing in total production and will be reflected mainly in consumption in economically developed countries. This will not only bring new impetus for higher economic growth, but also changes for the whole of society. Although the European Union supports the creative industry there is still not any unification concept of the creativity. That is why there is a need to formulate a new paradigm in a form of creative economy, so that we would be able to understand the role of creativity in economic and social development. The Global Creativity Index (GCI) was designed in such a way to come from the definition of creative economy while eliminating discrepancies of some previous models. The GCI is a broad-based measure for advanced economic growth and sustainable prosperity based on the 3Ts of economic development—talent, technology, and tolerance. To examine the relationship between the GCI and the various performance indicators we used the Pearson correlation analysis as the relevant statistical method. The current outputs have shown that regions with a significant economic level are achieving a higher rate of creative potential, more favourable demographic structure, better results in employment and in other macroeconomic indicators. We found out the positively strong correlation between the Global Creativity Index and the persons employed by the active enterprises in the Slovak creative industry. The understanding of the concept of creative economy and its measurement is the first step for setting strategy that will lead to ensuring competitiveness in today's global world.

*Keywords: creative industry, creativity index, GCI, Spearman correlation*

## 1 INTRODUCTION

Creativity in the broader sense of the word is associated with concepts such as creative thinking, problem solving, novelty, originality. We can find it in all areas of human life, in arts and culture, business, science, sport, and etc. However, the result of creative activity should also meet the criteria of meaningfulness, usefulness, imagination (Kloudova, 2009). Creativity was mainly dealt with by psychologists, today it is an important subject of research in economics, management, arts, science and other fields. From a psychological point of view, Hartl and Hartlova (2000) understand creativity as a capability that is characterized by such mental processes that lead to ideas, solutions, concepts, art forms, theories or products that are unique and unusual. There are a number of definitions based on the definition of relationships and contexts to explain creativity. Mikulastik (2010) defines creativity as “the ability to create new and original values in the fields of scientific, artistic, technological, social, economic, commercial and applied in all other activities, that one does in daily work”. In the past, creativity was seen as an ability, and later as a property. Nowadays, description of creativity is often used as an attitude to the world. In economics and technology, the aspect of meaningfulness, utility, implementation is important (Mikulastik, 2010).

Performance definitions and measurements acknowledged by creative industry practitioners and by creative industry experts and academic researchers might differ. Defining and measuring such a broad and complex concept as performance in the creative industry is bound to be fraught with difficulties and riddled with controversies. The present chapter focuses on the methods measuring the performance of the creative industry and its enterprises, under the assumption that it accurately represents the former—a task that all authors reviewed below set out to fulfil and that these differences, if any, are marginal. With the collective property premise in mind, the value and by extension, performance of the creative industry becomes very difficult to objectively assess, let alone quantify.

## **2 THEORETICAL BACKGROUND**

The creative industry is among the fastest growing industries in the world. Its major contribution to the world economy was announced by the Paris Conference on December 5, 2015, where the first survey mapping the impact of creative industry on the world economy was presented.

In Slovakia, Antalova and Barta (2013) tried to quantify the creative society. Based on the methodology of Florida and his associates, they created their own creativity index, so-called Slovak-Creativity index, which is a synthetic indicator consisting of three partial indices - the human capital index, the scientific talent index and the innovation index. Based on the population and housing census in Slovakia in 2011, they evaluated the human capital index as a percentage of the population with tertiary education with permanent residence in the Slovak Republic. In 2011, it was 13.8%, up by 6 percentage points compared to 2001, and a year-on-year increase of 0.7% for 2012. The scientific talent index was designed by R&D personnel in FTE (full-time equivalents). Based on a 10-year assessment, the authors found an increasing trend in the number of researchers, which is also a prerequisite for the growing chain of scientific talent, an average of 4% year-on-year over the last decade. The number of patents per million inhabitants has been set for the calculation of the innovation index. Research showed a year-on-year declining trend in the number of patents granted to domestic applicants; the resulting innovation chain index in 2007-2011 was declining, an average of 13% year-on-year. a prerequisite for a growing scientific talent chain index, an average of 4% year-on-year over the last decade.

Balog et al. (2015) analysed the state of the creative industry in Slovakia, also suggests solutions usable in Slovakia and looking for answers to current challenges. In terms of size and the importance of the creative sector in the economy lists two main ways of measuring. The first is based on a sectoral perspective which defines the sectors considered to be key for the development of creative economy (identification of the number of companies, their localization, size of employment, value added, etc.). The second defines the creative economy in terms of career prospects (no matter in which sector of creative workers act). The combined approach combines both classifications and makes it possible to identify creative workers both in and outside the creative industry (Balog et al., 2015). The publication found that for the development of the creative industry in Slovakia, it is necessary to complete the necessary infrastructure, implement mechanisms enabling cross-sector cooperation and cross-sector mobility, so that sectors can make greater use of each other potential of creative industry. Several geographically localized areas with an above-average concentration of creative industry have been identified in Slovakia. It was also noted that there is a need to create the preconditions for transforming local concentrations into integrated clusters, to introduce specialized support programs aimed at the creative industry, which are still lacking. In the context of human

resources and their quality, support in the education system is needed through systematic actions aimed at developing creativity and entrepreneurial skills.

Entrepreneurs from the creative industry have specific characteristics:

- a) they operate in demanding market conditions;
- b) produce goods that are inherently ‘cultural’;
- c) with people who are often more content-oriented than commercial;
- d) usually create very small businesses that exist on a permanent network.

Several researches confirm that creativity is characterized by a strong agglomeration of enterprises. Klasova, Korobanicova and Burger (2017) in their research focused on the impact of agglomeration savings on employment growth in creative industry in Slovakia. The aim of their study was to investigate what type of agglomeration savings stimulated employment growth in creative industry in Slovakia in the period 1998–2014 in relation to the use of agglomeration savings effects prevailing in the given territory for regional policy instruments. Through an econometric model, they quantified the impact of three agglomeration savings (related diversity, unrelated diversity and location savings) on employment growth. They found that related diversity was an important factor in employment growth in the analysed periods, and the districts that had a higher specialization in related industry had higher average annual employment growth. While related diversity had a significant positive impact on employment growth, Marshall's location savings had a negative impact. The results confirmed that for the effective transfer of knowledge, interactive learning and consequently job creation in creative industry, it is important to specialize the district not only on one selected creative sector, but on related industries that share a similar cognitive and technological base.

### **3 METHODOLOGY**

Creativity is increasingly becoming the essence of innovation and economic growth in the countries all over the world. The Global Creativity Index (GCI) provides a basic assessment of competitiveness in creativity and sustainable growth in 139 countries. The assessment of countries is done by measuring 3T economic development - technology, talent and tolerance. The best country in creativity according to the Global Creativity Index is Australia, followed by the USA, New Zealand and Canada.

Based on a modification of the creativity index compiled by Florida and his other collaborators, Antalova and Barta (2013) created the Creativity Index for the Slovak Republic's social and economic conditions by summarizing six indicators in the Talent Index, the Technology Index and the Tolerance Index. Talent index is the sum of the indicator of the share of the population with tertiary education in the total population and the indicator of the share of creative jobs in the total employment. They used the ratio of R&D costs to GDP as indicators of the technology index and the number of patent applications per inhabitant of the region. The indicators of the tolerance index were the share of registered partnerships in the region in the total population of the region and the share of immigrants in the total population of the region. Creative index for the Slovak Republic was simplified in order to be able to obtain individual data from available statistical surveys, while maintaining sufficient information. The aggregate Creativity index calculation was based on the average value of its sub-indices.

We decided to analyse the measurement of creative industry entities' performance by the economic indicators such the number of active enterprises, an employment and turnover. We also research correlation between the global creativity index for the Slovak Republic and the

number of active enterprises in the Slovak Republic. In our paper, we articulated the following research questions:

- 1) *Exists any universal methodology for the measuring the performance of the creative industry suitable for the Slovak Republic?*
- 2) *Is any relation between the values of the Global creativity index in the Slovak Republic and the overall number of active enterprises in the Slovak Republic?*
- 3) *Is any relation between the values of the Global creativity index in the Slovak Republic and the overall number of persons employed in the creative industry in the Slovak Republic?*

For calculating the latest values of the GCI in the Slovak Republic we used the public available data sources as the database of the Statistical Office of the Slovak Republic and Eurostat. Firstly, we counted the values of the sub-indices as the Talent index, the Technology and the Tolerance index. The reached values were used for computing the overall GCI in the Slovak Republic. To provide the Pearson correlation analysis we exploited the statistical software PSPP, which is application for analysis of the sampled data.

## 4 RESULTS

When measuring creativity logical question arises: what do we measure when we measure creativity? From a psychological, sociological and economic point of view, creativity is understood as an ability. It cannot be measured, but it can be measured as creativity indicators. There are several approaches to measuring creativity. Florida uses the 3T model applied in both the Global Creativity Index and the Euro-Creativity Index, in terms of the Czech Republic used 3T model Kloudova (2009).

Table 1 shows countries placed in the ranking of the Global creativity index between the 30th and the 41<sup>st</sup> place. Slovakia reached the 41<sup>st</sup> place with value 0.476 in the mentioned ranking published in 2011.

Tab. 1 – The Global Creativity Index (Rank 30-41). Source: Martin Prosperity Institute (2011)

TOTAL RANK	COUNTRY	TECHNOLOGY	TALENT	TOLERANCE	GLOBAL CREATIVITY INDEX
30	Russian Federation	21	13	74	0.541
32	Costa Rica	43	42	26	0.528
32	Estonia	27	15	69	0.528
34	Latvia	39	14	60	0.520
35	Croatia	29	39	46	0.516
36	United Arab Emirates	–	49	38	0.513
37	Uruguay	63	46	9	0.500
38	Argentina	55	36	31	0.484
38	Lithuania	31	16	75	0.484
40	Bulgaria	40	38	45	0.480
41	Slovakia	36	33	55	0.476
41	Poland	37	29	58	0.476

The Global Creativity Index measured in 2015 for the Slovak Republic reached the value at 0.484. However, it meant the decrease in the ranking place from the 41<sup>st</sup> position to 54<sup>th</sup> position (Table 2). The value of the Global Creativity Index arose but the position in the GCI ranking was lower.

Tab. 2 – The Global Creativity Index (Rank 51-60). Source: Martin Prosperity Institute (2015)

THE GLOBAL CREATIVITY INDEX					
Rank	Country	Technology	Talent	Tolerance	Global Creativity Index
51	Lithuania	65	12	105	0.490
52	Philippines	54	65	53	0.487
54	Slovak Republic	69	42	66	0.484
54	Serbia	70	45	58	0.484
54	Greece	39	43	101	0.484
56	Panama	70	67	34	0.482
57	Iran	–	71	72	0.481
58	Croatia	60	39	81	0.481
59	Mauritius	–	76	68	0.477
60	Venezuela	40	83	61	0.466

The position of the capital Bratislava region relates to its significantly higher tolerant attitudes than in the rest of Slovakia, what can be explained by the degree of urbanisation and more cosmopolitan character. The region of Banska Bystrica (BC), which is comparatively well performing in human capital and creative outputs, is losing in Tolerance and Technology dimensions (figure 1). There has been no doubt about the exclusive position of Bratislava region in the index measuring the regional creative potential. Proximity to creative centres is not an unambiguous factor of creative performance. Economic development spread from Bratislava to neighbourhood regions visible in the Technology dimension does not result in higher creative outputs or better cultural environment.

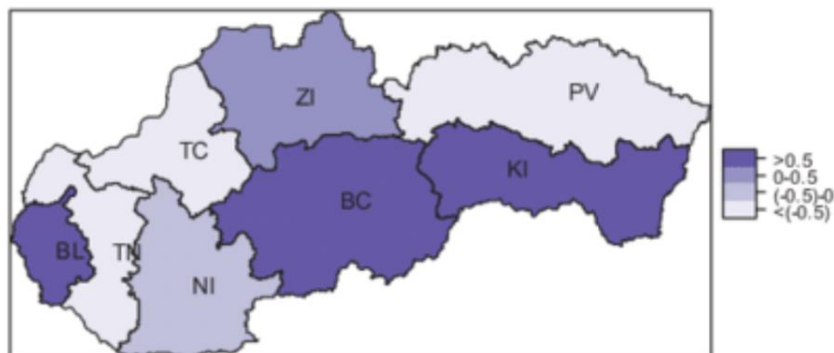

Fig. 1 – Distribution of the Slovak Creativity Index in 2016. Source: Hudec & Klasova (2016)

We found out that there is the positive strong correlation between the Global Creativity Index of the Slovak Republic and the population of active enterprises in the Slovak creative industry (table 3). The population of active enterprises in the Slovak creative industry had increased by 31 %.

Tab. 3 – Correlation between GCI and population of active enterprises in Slovakia. Source: own research

		GCI	Enterprises
GCI	Pearson Correlation	1.00	0.81
	Sig. (2-tailed)		0.394
Enterprises	Pearson Correlation	0.81	1.00
	Sig. (2-tailed)	0.394	

Due to the relatively small sample, the level of significance (p-value = 0.394) was low. All hypothesis tests ultimately use a p-value to weigh the strength of the evidence (what the data are telling you about the population). The p-value is a number between 0 and 1.

The results of the Pearson correlation analysis are shown in the table 4. The relation between the Global Creativity Index and persons employed by the active enterprises in the Slovak creative industry was positively correlated (0.97). The p-value was 0.143, which is higher than 0.05. The level of significance was low in this case.

Tab. 4 – Correlation between GCI and persons employed in the Slovak creative industry. Source: own research

		Employ	GCI
Employ	Pearson Correlation	1.00	0.97
	Sig. (2-tailed)		0.143
GCI	Pearson Correlation	0.97	1.00
	Sig. (2-tailed)	0.143	

## 5 CONCLUSION

Given the growing importance of the creative economy, there is an increasing need to measure its output and select statistical indicators. The measurement of the output of the creative economy is influenced by the different economic-cultural environment in individual countries, while there is a significant difference between the American and European approaches. We can conclude the answer to the research question no. 1 as following: there are lot of the methodologies for measuring the performance of Creative industry in general, but in the conditions of the Slovak republic the most suitable methodology is provided by Hudec and Klasová (2016). We found out strongly positive relation between the GCI and the population of active enterprises in the Slovak creative industry. The similar results were in the case of the GCI and persons employed by active enterprises in the creative industry. Limitations of our results are the relatively small significances (p-values were higher than 0.05). In the further research we will analyse more complex data for the bigger sample.

## References

- Antalova, M., & Barta, M. (2013). Kreativna spoločnosť – prístupy k jej kvantifikácii v Slovenskej republike. *Nová ekonomika*, 4(6), 157-165.
- Balog, M. et al. (2015). *Možnosti rozvoja kreatívneho priemyslu na Slovensku*. Bratislava: Slovenská inovačná a energetická agentúra.
- Benita, F. (2019). On the performance of creative industries: Evidence from Mexican metropolitan areas. *Papers in Regional Science*, 98(2), 825-842. doi: 10.1111/pirs.12403
- Boix-Domenech, R., & Soler-Marco, V. (2017). Creative service industries and regional productivity. *Papers in Regional Science*, 96(2), 261-280. doi: 10.1111/pirs.12187.
- Cerisola, S. (2019). A new perspective on the cultural heritage development nexus: the role of creativity. *Journal of Cultural Economics*, 43(1), 21-56. doi: 10.1007/s10824-018-9328-2
- Cerisola, S. (2018). Creativity and local economic development: The role of synergy among different talents. *Papers in Regional Science*, 97(2), 199-209. doi: 10.1111/pirs.12254
- Florida, R. (2014). The Creative Class and Economic Development. *Economic Development Quarterly*, 28(3), 196-205. doi: 10.1177/0891242414541693
- Florida, R. (2002). *The Rise of the Creative Class: And How It's Transforming Work, Leisure, Community, and Everyday Life*. New York: Basic Books.
- Hartl, P., & Hartlova, H. (2000). *Psychological Dictionary*. Praha: Portál.



- Hudec, O., & Klasova, S. (2016). Slovak Creativity Index – A PCA Based Approach. *European Spatial Research and Policy*, 23(1), 47-64. doi: 10.1515/esrp-2016-0003
- Kloudova, J. (2009). Measurement of the Creative Economy. *Journal of Economics*, 57(3), 247-262. Retrieved from [researchgate.net/publication/296846299\\_Measurement\\_of\\_the\\_Creative\\_Economy](http://researchgate.net/publication/296846299_Measurement_of_the_Creative_Economy)
- Lemmetyinen, A. (2019). Entrepreneurship in culture and creative industries: Perspectives from companies and regions. *International Small Business Journal – Researching Entrepreneurship*, 37(4), 417-418. doi: 10.1007/978-3-319-65506-2
- Martin Prosperity Institute. (2015). *The Global Creativity Index 2015*. Retrieved from <http://martinprosperity.org/content/the-global-creativity-index-2015/>
- Martin Prosperity Institute. (2011). *Creativity and Prosperity: The Global Creativity Index*. Retrieved from [http://martinprosperity.org/wp-content/uploads/2011/10/Creativity-and-Prosperity\\_The-Global-Creativity-Index.pdf](http://martinprosperity.org/wp-content/uploads/2011/10/Creativity-and-Prosperity_The-Global-Creativity-Index.pdf)
- Mikulastik, M. (2010). *Communication skills in practice*. Praha: Grada.
- Rybárová, D., Štetka, P., & Šagátová, S. (2018). Influence of Innovation Activity on Company Performance. In K. Hammes, I. Klopotan & M. Nestorovic (Eds.), *Economic and Social Development*. Varazdin: Varazdin Development and Entrepreneurship Agency.
- Stejskal, J., & Hajek, P. (2019). Modelling collaboration and innovation in creative industries using fuzzy set qualitative comparative analysis. *Journal of Technology Transfer*, 44(3), 981-1006. doi: 10.1007/s10961-017-9638-0
- Šagátová, S., & Rybárová, D. (2018). Opportunities for the Development of Human Capital in the Enterprise. In S. Deáková, Z. Dvořáková & P. Suchánek (Eds.), *Stabilization of Human Capital in Slovak Enterprises as an Immanent Determinant of their Success, Competitiveness and Sustainable Development*. Brno: Masaryk University.
- Tassabehji, R., Mishra, J. L. & Dominguez-Pery, C. (2019). Knowledge sharing for innovation performance improvement in micro/SMEs: an insight from the creative sector. *Production planning & control*, 30(10-12), 935-950. doi: 10.1080/09537287.2019.1582101

## Contact information

### **PhDr. Mária Kmety Barteková, Ph.D.**

University of Economics in Bratislava, Faculty of Business Management  
 Dolnozemska cesta 1, 85235, Bratislava, Slovak Republic  
 E-mail: maria.bartekova@euba.sk  
 ORCID: 0000-0003-2691-3185

### **Ing. Monika Raková, Ph.D.**

University of Economics in Bratislava, Faculty of Business Management  
 Dolnozemska cesta 1, 85235, Bratislava, Slovak Republic  
 E-mail: monika.jancovicova@euba.sk  
 ORCID: 0000-0002-8296-3657

doi: 10.7441/dokbat.2019.053

# THE ROLE OF TRADE MARKETING FUNCTION IN MARKETING-SALES INTERFACE

*Daniela Kolouchová*

## **Abstract**

Sales and marketing are two crucial functions responsible for a company's success in the marketplace. However, in reality, there are many conflicts at all organizational levels of marketing and sales functions. There is a continuing debate on the working relationship between sales and marketing among authorities. Nowadays, a few retail chains are controlling the majority of the market, and consequently, consumer goods companies are professionalizing their new function - trade marketing department. Department, which has a strong influence on sales and marketing functions. These circumstances are offering new options to focus intensively on exploring the phenomenon of the trade marketing department as a possible harmonizing mechanism of the marketing-sales relationship. For the research purpose, the qualitative discovery-oriented approach was employed. In-depth interviews help to obtain a deep understanding of the studied phenomenon. The sample consisted of 11 sales and marketing professionals that came from three different FMCG companies operating in the Czech food and cosmetic mass markets. The research revealed three scenarios of the trade marketing fine-tuning role in the marketing-sales interface.

**Keywords:** *sales-marketing interface, marketing function, sales function, trade marketing function*

## **1 INTRODUCTION**

The generally accepted theory of a market-oriented company says that the marketing department should be the strategic department responsible for creating a long-term strategy for the company. This vision predetermines marketing to act as an integrating element between the market and other business departments. Marketing collaborates very closely with the production department, logistic, purchasing, sales, research and development, finance (Kahn & Mentzer, 1998). The closest relationship exists between the marketing and sales departments (Kotler, Rackham & Krishnaswamy, 2006). Better cooperation between these two departments leads to higher customer satisfaction and positively influences company results, including sales performance (Guenzi & Troilo, 2007).

All processes in the company should allow close cooperation between sales and marketing teams. In reality, the mutual and smooth workflow between them is an exception. However, this relationship is characterized as the most problematic working relationship within the organization (Meunier-FitzHugh & Piercy, 2010). It suffers from the greatest difficulties and misunderstandings and leads to significant organizational friction (Oliva, 2006). Incurred conflicts are harassing, unpleasant, and sometimes even frustrating. The relationship between marketing and sales department was accurately described by Dewsnap and Jobber (2000) as a relationship with lack cohesion, poor co-ordination effort, high level of conflicts, non-cooperation, significant distrust, dissatisfaction with mutual communication and a strong presence of negative stereotypes.

The complexity of the relationship between marketing and sales departments have affected the fact that in recent years there has been a significant change in the relationship between manufacturers and retail chains in consumer goods markets. The importance of manufacturers

and their brands is decreasing, and the power of retail chains is growing. Independent stores have consolidated into large, mostly international, retail chains with significant bargaining power. They introduce private labels and their loyalty programs. The primary goal for retailers is not to sell the most successful brands in the market but to generate the highest profit (Jesenský et al., 2017). This situation builds new barriers in the marketing-sales interface.

## **2 LITERATURE REVIEW**

### **2.1 Integration Mechanisms in the Marketing-Sales Interface in Consumer Goods Manufacturers**

The area of integration mechanisms is the most frequent research focus in the field of marketing-sales interface studied in consumer goods companies. The mapping of integration mechanisms uses a multi-dimensional approach and involves both the interaction between two subjects and the cooperation between them. Scholars mention several integrative tools to improve a sales-marketing relationship. The most frequently mentioned harmonizing factors in the consumer industry are the following: communication, cross-functional teams and projects, top management support, aligned goals and rewards.

Communication is often mentioned as the most effective integration mechanism (Meunier-FitzHugh & Piercy, 2010; Maltz & Kohli, 2000; Matthyssens & Johnston, 2006). It has to be controlled in order not to become overwhelming and annoying (Dawes & Massey, 2005). The increasing frequency of communication between groups is directly proportional to the growing conflict, and it is necessary to focus on the quality and efficiency of the selected communication channels (Rouziès et al., 2005). Communication improving information sharing between sales and marketing can take various forms. In addition to the existence of information systems such as market intelligence is essential to organize regular meetings or regular reports (Guenzi & Troilo, 2006). An important step is to define key terms that contribute to the clarity of internal communication (Oliva, 2006).

Many authors recommend creating multi-functional teams made up of both marketing and sales teams and optionally of other functional units (Rouziès et al., 2005; Homburg, Jensen & Krohmer, 2008). These teams may have different job descriptions, and they may address specific problems. Selected groups can be concentrated on one trade customer or one product launch, for example. Concerning consumer goods manufacturers, authors often refer to the emergence of working groups, concentrated on the most important retail chain customers (Dewsnap & Jobber, 2000). An everyday activity supporting the integration of marketing and sales is joint planning (Homburg, Jensen & Krohmer, 2008; Malshe, 2011) when marketing and sales develop the company's marketing strategy, plans, and goals together. This means a rather significant change from the typical planning process where marketing sets strategy, plan, and goals and sales department is responsible for their realization with retail customers (Cespedes, 1993).

The company's management can make a significant contribution to the integration of marketing and sales functions. Either by direct involvement or by indirect supporting activities. Senior executives can strengthen the integration of marketing and sales functions by signalling positive attitudes and publicly support the collaborative atmosphere in both departments (Meunier-FitzHugh & Piercy, 2010). A critical integration mechanism is the creation and implementation of shared goals and a building of a unified rewards system (Dewsnap & Jobber, 2000; Rouziès et al., 2005; Guenzi & Troilo, 2006). The assigned strategic tasks, the remuneration objectives, and rules for their fulfilment should be aligned in both departments (Strahle, Spiro & Acito, 1996). The goals for sales and marketing departments are not necessarily identical, but the

ultimate company goal, whether profit or turnover, shall be binding for both departments (Rouziès et al., 2005; Kotler, Rackham & Krishnaswamy, 2006). Lower levels of goals can be individual for each department, but they must logically relate to the ultimate goal, and they have to lead to its achievement.

## **2.2 Trade marketing function as an element of marketing-sales integration**

Significant changes in relationships between retailers and consumer goods manufacturers have required the implementation of a new unit at the sales-marketing organization level: trade marketing department. The need for trade marketing function has raised for two reasons. Firstly, centralized retailer chains are increasing the pressure on their suppliers – manufacturers and distributors. They are pushing suppliers to adapt product and brand offerings to their business needs (Dewsnap & Jobber, 2009). Secondly, there is a spiralling increase in promotion activities at retail chain stores, which are organized and paid by suppliers. This fact has raised the need for a specialized functional unit to be responsible for managing growing in-store communications and promotions (Thain & Bradley, 2012). The main objective of trade marketing is to develop cooperation between manufacturers and retailers and improve sales results on both sides. Trade marketing is responsible for "meeting the needs" of a retailer, not the end consumer (Cespedes, 1993).

When the trade marketing department professionalized and initially took over the brand management (marketing) activity at the point of sale, the impact of brand management on the brand in the retail environment decreased. This fact can lead to conflicts between marketing and trade marketing because brand management perceives promotional actions supporting the retailer's business needs as a threat to long-term brand consistency (Kessler, 2004). On the other hand, Dewsnap and Jobber (1999) emphasize the ability of trade marketing to link the business needs of retailers to the needs of the manufacturer's brand management.

Two reasons open the space for exploring this phenomenon in the local Czech mass-market environment. Current foreign literature has recently been somewhat marginally devoted to the complex exploration of the influence of trade marketing function on the sales-marketing interface. In addition, more there is a growing importance of trade marketing departments in the Czech manufacturer's environment. In-store communication investments paid by manufacturers or distributors are steadily growing in the Czech market — companies invested at the point of sale advertising 7.5 billion CZK in 2016 (Popai, 2018).

## **3 METHODOLOGY**

Given the lack of prior research that explicates research interest in the CEE region, the qualitative discovery-oriented approach was employed to examine the research question: Which integration role does the trade marketing department play in the marketing-sales interface in FMCG companies?

When selecting respondents, a form of criterion sampling was used. All cases were selected according to a predetermined criterion of importance in two steps (Miovský, 2009). First, the participating companies were chosen. The sample of 30 FMCG companies that participated in a previous research study oriented to the marketing-sales relationship (Kolouchová & Rožek, 2014) was chosen as a base. The final set consisted of three companies that fulfilled the following predetermined criterion: spontaneous mention of trade marketing as an integrating element from both sales and marketing respondents interviewed in the same company; the staff of all three departments is intensively communicating on a strategic and operational basis. In addition, more all three functions (marketing, trade marketing and sales) exist as an independent unit within an organizational structure, and their leaders are members of the top management.

All three international corporations are manufacturing and selling or distributing cosmetic or food products in the Czech FMCG market. Therefore, the sample was sufficiently homogeneous, and, on the other hand, it was possible to monitor potential differences.

The final sample of 11 respondents met the following criteria: at least one member of marketing department (brand management) and one member of sales department recruited in each company; at least two trade marketing managers recruited in two different companies; at least a half year of experience in the current senior management position; at least two years working experience for selected company. Data were collected through in-depth interviews. The interviews lasted 90 minutes and were conducted face to face in the informant's office. All respondents expressed a great willingness to participate in the research, and they were very interested in the study topic. They showed a high degree of openness during the interviews. All interviews were recorded and transcribed. Data were processed through qualitative thematic analysis (Braun & Clark, 2006) to generate significant themes.

## **4 RESULTS**

Generally speaking, research has confirmed that consumer markets in the Czech FMCG environment are no more driven by the demand of the end consumers or users and their need for branded products. Retail chains and their business interests play the central role. It is not the consumer who decides which brand will be offered on the shelves.

Retail trade is thinking more in product categories than in product brands. Trade customers need to grow their sales within a specific category of products with growth potential; retailer's turnover is not driven by sales of specific branded products. It is not essential which supplier and what brand will bring the highest turnover and margin into the preferred category. The retail chains dictate conditions of contracts with manufacturers, choose products and brands that will be listed and sold at their stores, influence price level, and marketing promotional activities of branded producers.

The trade marketing departments that are newly built on the suppliers' side are responsible for in-store communication and activities on the retailers' field. They have to balance between business needs of the retailer and sales and marketing needs of the manufacturer. Trade marketers play an important role for the sales department in organizing relevant promotions for an individual retail customer. On the other hand, they help to brand managers to sell brand ideas and novelties internally – to the sales department and externally – to retailers. Trade marketing department has logically become a significant influencer of the marketing-sales interface. Results of the study convey three main areas of positive trade marketing functional effect in the marketing-sales relationship trade marketing as a trade customer advocate, trade marketing as a transformation unit and trade marketing as an equal partner.

### **4.1 Trade marketing as a trade customer advocate**

Respondents from all departments perceived the trade marketing department as an essential member of the linear flow that begins in marketing (brand management) and ends in the retail chain. Brand management is the initial element in this linear model, and the retailer with its shop stays at the end. However, the retailer occupies the final position it can manage the whole process. New product ideas move from brand management through trade marketing to the sales department and via sales personnel to the retailer. In addition, the retailer is the final decision maker who accepts or refuses novelties.

Research results suggest that the trade marketing department plays the role of retail chain advocate in bellow mentioned linear process towards marketing managers. Trade marketing

defends the retailer's needs and strategies in the eyes of brand management. Trade marketing, however, does not take the advocate position solely towards brand management. It also behaves in the same way as the sales department. Trade marketing personnel persuades sales managers to invest in discounts and sales support only for products that fit into the growing categories defined by the retail chain.

#### **4.2 Trade marketing as a transformation unit**

Marketing and sales have a completely different set of operations. They are different in time planning horizon (long-term vs. short-term), orientation (brand vs. retail trade partner), and other aspects (Rouziès et al., 2005). The brand manager must necessarily look to the future. On the other hand, the sales personnel live in the present. As the study results confirmed, the trade marketing department helps to reduce these inconsistencies. Trade marketing seeks to transform a strategic brand management thinking into the near future that is feasible for salespeople.

Marketing (brand management) perceives trade marketing as a liberator from a particular perspective. Trade marketing responsibilities and activities allow marketing people to concentrate fully on the consumer and his needs, wants, motivation, and all the moments that affect the final user. Trade marketing transforms and translates product brand ideas into a sales and retailer environment using their terminology and arguments. Brand management does not have to deal with the complexity of a retailer's business requirements and is not responsible for the preparation and execution of promotions at stores. Marketing can fully focus on product brand planning and brand building. Trade marketing provides brand managers with sufficient feedback in the form of an information service about the strategies of key retailers, the possibility of implementing promotional activities in their shops, etc.

A trade marketer is the one who knows the customers (retailers) perfectly, understands their language, their KPIs, their thinking in categories. As a result, trade marketing managers try to transform brand marketing activities into success at the point of sales. In practice, for example, purely branded presentations full of consumer insights, know-how, unique technologies, and ingredients, etc., trade marketing must "translate" into the customer language using business argumentation that convinces the trade customer – retailer. Trade marketing translates big brand ideas into the sales language that salesperson buys and goes on to sell to the retailer. Trade marketing redefines the brand story into the trade story. The story has to be understandable and acceptable for both: external partner – retailer and internal partner – sales department.

#### **4.3 Trade marketing as an equal partner**

It is important to note here that brand managers and sales managers fully respect and trust the position of trade marketers and their professionalism. Trade marketing has intensive contact with customers (retailers) on several levels, not only in the form of cooperation on category management and preparation of visibility at point of sales. It leads to a deep knowledge of retailer business need and KPIs.

Respondents perceived the equal importance of all three departments, marketing (brand management), trade marketing, and sales very intensively. Respondents from sales and marketing departments realized that there is a necessity to have trade marketing professionals in the current disadvantageous negotiating position of manufacturers against powerful and concentrated retail chains. Without their knowledge and skills, salespeople would have more complicated negotiation positions and relationships with retail managers. Respondents showed mutual respect, confidence in the professionalism of others' work, despite slight reservations in the marketing-sales relation. Respondents perceived this three-sided relationship as a triumvirate, with precisely divided areas of competence, equal importance within the company,

and mutual alliances. In companies where regular three-sided meetings have been established, respondents consider the status of triumvirate very positive and very solid. Meetings that are not only informative but also solution-focused are highly appreciated. Of course, participants have to be equipped with appropriate competencies. This situation was illustrated by one of the marketing directors: "No one here is anyone's service. On the contrary... We have different opinions, sometimes diametrically. However, we always have to agree. If something goes wrong, we solve it without escalating conflicts on the CEO level."

The introduction of the trade marketing function is very beneficial for brand management respondents. Brand managers have a feeling that inter-functional marketing-sales conflict has shifted from a marketing-sales relationship level to a trade marketing-sales relationship level. Brand managers are no longer forced to create pressure on sales managers to implement novelties on the market and realized promotional activities at the point of sales in retail. Now it is trade marketing responsibility. Brand managers are even worried and concerned about their trade marketing colleagues because they perceive bargaining with sales managers as immensely frustrating. Marketers still do not fully realize that trade marketers are retail environment experts and people with strong negotiating skills.

## 5 DISCUSSION AND CONCLUSIONS

The research was focused on exploring a fine-tuning role of the trade marketing function in marketing-sales integration in the FMCG market segment. Marketing-sales interface is often described by authorities as problematic and full of frictions (Meunier-FitzHugh & Piercy, 2010; Oliva, 2006; Dewsnap & Jobber, 2000). Trade marketing department is a crucial business functional unit that was implemented in sales – marketing organization level because of retail chain strengthening power, and this trend already became significant also for the Czech mass market (Jesenský et al., 2017). The trade marketing department's ability to harmonize marketing-sales relationship was emphasized already by Cespedes (1993) or Dewsnap and Jobber (1999) and local research.

Findings delivered valuable insights from international companies operating in the local market. The research was primarily focused on FMCG companies playing an important role in the food and cosmetics market. All three companies are large global companies that transfer their organizational structures from foreign branches and have many years of experience in organizing marketing, trade marketing and sales functions in a highly competitive environment. The research outputs must, therefore, be related to the market segments in which the study was realized. The principles of trade marketing as an integration link between sales and marketing departments in other manufacturing or non-manufacturing sectors have to be explored and offers numbers or future research opportunities. The research sample was quite homogenous and relevant for a qualitative approach. An extensive quantitative study would help to quantify the relevance of individual harmonization effects significant in different industries, different sizes of companies, etc. Understanding important integration mechanisms in the marketing-sales interface will lead to better company performance.

### References

- Braun, V., & Clarke, V. (2006). Using Thematic Analysis in Psychology. *Qualitative Research in Psychology*, 3(2), 77-101. doi: 10.1191/1478088706qp063oa
- Carpenter, P. (1992). Bridging the Gap between Marketing and Sales. *Sales and Marketing Management*, 144(3), 28-31.

- Cespedes, F. V. (1993). Coordinating Sales and Marketing in Consumer Goods Firm. *Journal of Consumer Marketing*, 10(2), 37-55. doi: 10.1108/07363769310039111
- Dawes, P. L., & Massey, G. R. (2005). Antecedents of Conflict on Marketing Cross-functional Relationship with Sales. *European Journal of Marketing*, 39(11/12), 1327-1344. doi: 10.1108/03090560510623280
- Dewsnap, B., & Jobber, D. (2009). An Exploratory Study of Sales-Marketing Integrative Devices. *European Journal of Marketing*, 43(7/8), 985-1007. doi: 10.1108/03090560910961489
- Dewsnap, B., & Jobber, D. (2000). The Sales-Marketing Interface in Consumer Packaged-Goods Companies: A Conceptual Framework. *Journal of Personal Selling & Sales Management*, 20(2), 109-119. doi: 10.1080/08853134.2000.10754230
- Dewsnap, B., & Jobber, D. (1999). Category Management: A Vehicle for Integration between Sales and Marketing. *Journal of Brand Management*, 6(6), 380-392. doi: 10.1057/bm.1999.30
- Homburg, C., Jensen, O., & Krohmer, H. (2008). Configuration of Marketing and Sales: A Taxonomy. *Journal of Marketing*, 72(2), 133-154. doi: 10.1177/0092070300284001
- Kessler, C. (2004). Editorial: Branding in Store-Marketing in the 21st Century. *Journal of Brand Management*, 11(4), 261-264. doi: 10.1057/palgrave.bm.2540172
- Guenzi, P., & Troilo, G. (2007). The Joint Contribution of Marketing and Sales to the Creation of Superior Customer Value. *Journal of Business Research*, 60(2), 98-107. doi: 10.1016/j.jbusres.2006.10.007
- Guenzi, P., & Troilo, G. (2006). Developing Marketing Capabilities for Customer Value Creation through Marketing-Sales Integration. *Industrial Marketing Management*, 35(8), 974-988. doi: 10.1016/j.indmarman.2006.06.006
- Jesenský, D. et al. (2017). *Marketingová komunikace v místě prodeje*. Praha: Grada.
- Kahn, K. B., & Mentzer (1998). Marketing's Integration with Other Departments. *Journal of Business Research*, 42(1), 53-62. doi: 10.1016/S0148-2963(97)00068-4
- Kolouchová, D., & Rožek, J. (2014). Is it Possible to Improve the Relationship between Marketing and Sales? *Central European Business Review*, 3(4), 30-36.
- Kotler, P., Rackham, N., & Krishnaswamy, S. (2006). Ending the War between Sales & Marketing. *Harvard Business Review*, 84(7/8), 68-78.
- Malshe, A. (2011). An exploration of key connections within sales-marketing interface. *Journal of Business & Industrial Marketing*, 26(1), 45-57. doi: 10.1108/08858621111097201
- Maltz, E., & Kohli, A. K. (2000). Reducing marketing's conflict with other functions: The differential effects of integrating mechanisms. *Journal of the Academy of Marketing Science*, 28(4), 479-493. doi: 10.1177/0092070300284002
- Matthyssens, P., & Johnston, W. J. (2006). Marketing and Sales: Optimization of a Neglected Relationship. *Journal of Business & Industrial Marketing*, 21(6), 338-345. doi: 10.1108/08858620610690100
- Meunier-FitzHugh, K. L., & Piercy, N. F. (2010). Improving the Relationship between Sales and Marketing. *European Business Review*, 22(3), 287-305. doi: 10.1108/09555341011040985
- Miovský, M. (2009). *Kvalitativní přístup a metody v psychologickém výzkumu*. Praha: Grada.



- Oliva, R. A. (2006). The Three Key Linkages: Improving the Connections Between Marketing and Sales. *Journal of Business & Industrial Marketing*, 21(6), 395-398. doi: 10.1108/08858620610690155
- Popai. (2018). Čistý objem trhu reklamy v místě prodeje vzrostl o 11 %. Retrieved from <http://www.popai.cz/novinky/1cisty-objem-trhu-reklamy-v-miste-prodeje-vzrostl-o-11>
- Thain, G., & Bradley, J. (2012). *Store Wars: The Worldwide Battle for Mindspace and Shelfspace, Online and In-store*. Chichester: Wiley.
- Strahle, W. M., Spiro, R. L., & Acito, F. (1996). Marketing and Sales: Strategic Alignment and Functional Implementation. *Journal of Personal Selling & Sales Management*, 16(1), 1-20. doi: 10.1080/08853134.1996.10754041
- Rouziès, D., Anderson, E., Kohli, A. K., Michaels, R. E., Weitz, B. A., & Zoltners, A. A. (2005). Sales and Marketing Integration: A Proposed Framework. *Journal of Personal Selling & Sales Management*, 25(2), 113-122. doi: 10.1080/08853134.2005.10749053

### Contact information

#### Ing. Daniela Kolouchová

University of Economics, Prague, Faculty of Business Administration  
W. Churchill Sq. 4, 13067, Prague, Czech Republic  
E-mail: Daniela.kolouchova@vse.cz  
ORCID: 0000-0002-0182-6686

doi: 10.7441/dokbat.2019.054

# COMPARISON EFFICIENT PRICE OF COMPENSATION OF SUBURBAN BUS TRANSPORT IN SELECTED REGIONS

*Natálie Konečná*

## **Abstract**

This paper deals with an efficient price compensation of suburban bus transport in 24 selected areas of Moravian-Silesian Region and Olomouc Region. Namely, these areas are discussed – Karviná, Orlová, Frýdlant, Nový Jičín East and West, Krnov, Bruntál, Rýmařov, Opava, Vitkov, Frýdek-Místek, Bílovec, Olomouc Northeast, Olomouc Southwest, Prerov North and Lipnicko, Hranicko, Sternberg and Uničovsko, Přerov South, Litovelsko, Prostějov Northwest, Šumperk North, Šumperk South, Mohelnice, Zábřeh. In these areas, tenders have been opened within 2018 – 2019 and contract has been concluded with the chosen carrier. All used data from MSR are accessible in the National Electronic Tool (NEN). All used data from Olomouc Regions (OR) are from the Tenderarena electronic marketplace. To estimate technical efficiency, the output-oriented DEA model was chosen with constant and variable returns to scale working with one input variable (competitive price for 1 vehicle-kilometre) and two output variables (number of connections and number of vehicle-kilometres). Based on the performed analysis, it was found that more than 50% of contracted compensations was inefficient. The degree of inefficiency is very dispersed in output-oriented CRS (constant returns to scale) and VRS (variable returns to scale) models. Based on the selected model, only the outputs that have been used in the model can be objectively evaluated.

*Keywords: bus transport, Data Envelopment Analysis, efficiency, compensation*

## **1 INTRODUCTION**

The paper stresses the topic of provision of transport service at region level based on the Act No. 194/2010 Coll. on public passenger transport service as amended in context with efficiency of public expenditure and public services. In this case, public expenditure means price compensation and public service means the provision of transport services.

From § 5 of the Act No. 194/2010 Coll., on public passenger transport service as amended also follows the duty for the Ministry of Transport as well as for particular regions to create a transport service plan for at least 5 years period. the aim of this plan is a formulation of regions' ideas in this field. Kleprlík (2013) deals with the analysis of this plan in his paper. He mentions deficiencies in those plans and offers possible solutions whether legislation or plan's character is meant.

The effective price of compensation is evaluated in terms of Moravian-Silesian (MSR) and Olomouc Regions (OR) and takes 10-year contracts concluded between carriers and contracting authorities thus regions. As it results from the act, regions are obligated to publish the transport service plans in a way to allow a distant access. This duty is followed by both regions. Moravian-Silesian Region determines the strict period, for which such plan is created and when it is updated; currently the plan for the period 2017 – 2021 is valid. As far as Olomouc region is concern, it has chosen to create the plan for the period of 5 years being updated continuously. Responsibility for organizing and providing a complex transport service in Olomouc region is taken by the Coordinator of Integrated Transport System of Olomouc Region. Since 2015, this state-funded institution is also in charge to ensure tenders followed by conclusion of contracts on public passenger transport services. Moravian-Silesian Region creates the plan on its own

as well as organizes public tenders and contracts. It uses external administration as it comes to tenders. Kleprlík (2013) says that, in his opinion, the Transport Service Plan of MSR belongs to the best elaborated plans within the published plans.

Hanauerová (2019), who also uses the DEA method, is also assessing the technical efficiency of public procurement in bus transport. Adequate price compensation is dealt by Dementiev (2018). Migliore et al. (2013) discusses the accessibility of public transport, which would lead to increased efficiency and purposefulness of this public service. In his case study, Ivan (2010) deals with efficiency of public transport compared to car transport.

In the Moravian-Silesian Region and Olomouc Region, the public bus transport is provided on the basis of public service contracts. These contracts are concluded in two regimes, according to the Act No. 111/1994 Coll., on road transport (without a tender) and the Act No. 134/2016 Coll., on public procurement, as amended.

In the frame of public service contracts concluded on the basis of a public procurement procedure pursuant to the Act No. 134/2016 Coll., on public procurement, as amended, the range of transport services within particular areas of the region is set to meet the condition of transport ensuring by the Act no. 194/2010 Coll., on public services. Due to the market environment, the price of transport performance should be lowered and thus financial savings would be achieved throughout the entire region. Thus, the paper is focused on 12 areas of the Moravian-Silesian Region and 12 areas of the Olomouc Region, in which the tendering procedure has been initiated and the public service contract has been fulfilled in the period of 2018 - 2019. Namely, these areas are discussed – Karviná, Orlová, Frýdlant, Nový Jičín East and West, Krnov, Bruntál, Rýmařov, Opava, Vitkov, Frýdek-Místek, Bílovec, Olomouc Northeast, Olomouc Southwest, Prerov North and Lipnicko, Hranicko, Sternberg and Uničovsko, Přerov South, Litovelsko, Prostejov Northwest, Šumperk North, Šumperk South, Mohelnice, Zábřeh (MSR Plan of transport services for 2017 – 2021, Olomouc Region Plan of transport services)

**The aim of the paper is to compare and evaluate technical efficiency of 10-year compensation of suburban bus transport in 12 MSR and OR areas by chosen inputs and outputs.** Technical efficiency is estimated based on output-oriented Data Envelopment Analysis model (further DEA). For evaluation purpose, there are 2 research questions to be verified (RQ):

RQ1: Is more than 50% contracted compensation efficient?

RQ2: What other factors can objectively influence the price of compensation besides chosen outputs – number of connections and vehicle-kilometres?

### **1.1 Compensation in bus transport**

The customer is entitled to select the carrier by the Act No. 194/2010 Coll., on public services in the carriage of passengers, as amended, either based on an invitation to tender or through direct request. Direct request may be used if the conditions of Regulation (EC) No. 1370/2007 of the European Parliament and of the Council are met. In the Czech Republic, this Regulation is followed by Decree No. 296/2010 Coll., on the procedures for establishing the financial model and determining the maximum amount of compensation. This decree adjusts the method of the financial model composition. (Baroch et al., 2015)

The Regulation (EC) No. 1370/2007 of the European Parliament and of the Council on the rail and road public passenger transport services and cancellation of the Council Regulations No. 119/69 and No. 1107/70 implies that public service compensation means "*any benefit, in particular financial, granted directly or indirectly by the competent authority from public*

*sources during or in connection with the period of implementation of the public service obligation".* In general, price compensation can be understood as a subsidy from public budget, i.e. from the ordering party. In other words, it is a compensation that the ordering party undertakes in the contract. In case of carrier selection based on the tender procedure, pursuant to the Act No. 134/2016 Coll., on public procurement, reasonable profit becomes the subject to competition. (Hanauerova, 2018)

The Act No. 194/2010 Coll., on public passenger transport services, as amended, determines that the amount of compensation must be reasonable, otherwise the ordering party is not allowed to conclude the contract. If the contract is still concluded, it becomes invalid. In case of direct request, prior to the conclusion of the contract, the selected carrier is required to submit a financial model of costs, revenues and net income. Similarly, the selected carrier shall submit the financial model in case of tender before signing the contract, unless otherwise specified in the tender. (Baroch et al., 2015)

## **2 METHODOLOGY AND DATA**

The estimation of technical efficiency of contracted compensations in bus suburban transport under the conditions of 12 MSR and 12 OR areas was provided by determination of 1 input and 2 outputs for estimation of technical efficiency, statistical description of selected variables (see Table 1); by calculation of output-oriented efficiency model by DEA model, which takes constant returns to scale (CCR) into account, by the formula (1); and by calculation of output-oriented efficiency model by DEA model, which takes variable returns to scale (BCC) into account, by the formula (2).

The core of DEA method is in division of investigated objects to effective and ineffective ones by the size of consumed sources and number of performed production or other type of output. By DEA models, empiric production function is determined. The DEA model compares units with the best units. The DEA models are based on premises that for given problem, there exist a production possibility set created by all possible combinations of inputs and outputs. A production frontier determines optimum relation between inputs and outputs aiming at a maximization of outputs under given input value (or more inputs). The production possibility set is determined by efficient frontier. To estimate what this efficient frontier and thus production possibility set would be, it is necessary to adopt an assumption on character of returns to scale for given problem.

Output-oriented models calculate the technical efficiency coefficient, which is determined by the ratio of the weighted sum of inputs to the weighted sum of outputs, but weights are sought so that the value of coefficient  $g$  is greater than or equal to one. Thus, for the effective unit  $U_q$  the coefficient  $g = 1$  and for the inefficient unit  $g > 1$ .

Cooper et al. (2007) considers the CCR (Charnes, Cooper and Rhodes surname designation) a basic DEA model, which assumes constant returns to scale. Also, the BCC model (designation according to the surnames of the authors of the model Banker, Charnes and Cooper), which assumes variable returns to scale. In case of constant returns to scale (CRS), the efficient frontier is possible to reach by increasing the value of output consumed while maintaining current input level – output-oriented models; by reducing the value of input used while maintaining the current output level – input-oriented models; and by combination of both approaches - additive models, slack-based models. (Jablonský & Dlouhý, 2015; Vrábková, Vaňková, 2015)

Output-oriented model CCR can be formulated as follows:

$$\begin{aligned}
 g &= \sum_j^m v_j x_{jq} \\
 \sum_i^r u_i y_{ik} &\leq \sum_j^m v_j x_{jk} & k = 1, 2, \dots, n \\
 \sum_i^r u_i y_{iq} &= 1 \\
 u_i &\geq \varepsilon & i = 1, 2, \dots, r \\
 v_j &\geq \varepsilon & j = 1, 2, \dots, m
 \end{aligned} \tag{1}$$

Output-oriented model BCC can be formulated as follows:

$$\begin{aligned}
 g &= \sum_i^m v_j x_{jq} + v \\
 \sum_i^r u_i y_{ik} &\leq \sum_j^m v_j x_{jk} + v & k = 1, 2, \dots, n, \\
 \sum_i^r u_i x_{iq} &= 1 \\
 u_i &\geq \varepsilon & i = 1, 2, \dots, r, \\
 v_j &\geq \varepsilon, & j = 1, 2, \dots, m. \\
 v &- free
 \end{aligned} \tag{2}$$

Input set for efficiency evaluation is created by competed price (X1), output set is created by 2 variables – number of connections (Y1) and number of vehicle-kilometres (vkm) (Y2).

### Input

X1 – competed price (CZK/vkm). It means the price compensation for the carrier for 1 performed vkm. The data of the MSK are accessible in the National Electronic Tools (NEN). The Olomouc Region publishes public tenders in the electronic marketplace TENDERARENA - electronic tool eGordion.

### Outputs

Y1 – number of connections being requested by MSR and OR. Detailed specification of connections is determined in the Tender documentation, which is accessible in electronic form in the National Electronic Tool – Tender documentation (NEN) and TENDERARENA.

Y2 – assumed number of driven vehicle-kilometres by the selected carrier in given locality within 10 years. This number is also mentioned in the Tender documentation related to concrete procedure, which is also accessible in the National Electronic Tool (NEN) and TENDERARENA.

Tab. 1 – Statistic characteristic of input and outputs. Source: own research

	Min.		Max.		Mean		Median		SD	
	MSR	OR	MSR	OR	MSR	OR	MSR	OR	MSR	OR
<b>X1 – competed price (CZK/1vkm)</b>	33.57	30.46	38.14	36.2	36.61	34.13	37	34.49	1.29	1.69
<b>Y1 – number of connections</b>	9	9	43	22	20.5	15.67	17	15.5	10.14	3.66
<b>Y2 – vkm/10 years</b>	8 350 812	10 369 140	39 383 743	24 442 080	21 620 005	14 502 160	19 738 088	13 943 930	9 196 137.1	3866356.23

Table 1 shows that the lowest competed price in MSR was 33.57 CZK/vkm. This price was competed for Krnov area. Olomouc region was successful to compete even lower price – 30.46 CZK/vkm for Šternberk and Uničov area. Contrary to that, the highest price, 38.14 CZK/vkm MSR competed for Frýdlant area. In Olomouc region, the highest price compensation is

concluded for Litovel area (36.20 CZK/vkm), Average competed price (out of 12 chosen areas) was 36.61 CZK/vkm. Olomouc region shows lower average competed price compared to MSR – 34.13 CZK/vkm. Median of competed price for MSR is 37 CZK/vkm, in OR, it is 34.49 CZK/vkm. Standard deviation is 1.29 in MSR and 1.69 in OR.

Considering the output side, there are two variables chosen - the number of connections and the estimated number of driven kilometres within the time period of 10 years were chosen. The Table 1 shows that in both regions, there is the same number of connections (9); in MSR, it is Karviná area and in OE, it is Přerov South. The highest number of connections (43) was required by MSR for the Nový Jičín East area, while OR demands the highest number of connections of Zábřeh area (22), which is almost by  $\frac{1}{2}$  less. The average number of connections in MSR is 20.5 per area, in OR it 15.67 connections. The median of this chosen output is 17 for MSR and 15.5 for OR. The standard deviation of the output (Y1) is 10.14 (MSR) and 3.66 (OR).

The second chosen output is defined as the number of vkm in given area requested by the contracting authority. The least vehicle-kilometres were requested by MSR for the Frýdlant area (8,350 th. vkm/10year), while the highest number of vkm is needed to be driven in the Nový Jičín West area (39,383 th vkm/10year). As it can be seen in the Table 1, in OR the number of driven vkm is higher compared to MSR, namely Olomouc SW area (10,369 th. vkm/10year). As it comes to the highest number of needed driven vkm, in OR, Prostějov SW is considered (24,442th. vkm/10year). The average number of driven vkm is 21,620 th. /10 years in MSR and 14,502 th. in OR. The mean value for the number of driven kilometres is 19,738 th. vkm/10 years in MSR and 13,943 th. in OR. The standard deviation for output (Y2) is 9,196 th. vkm/10 years in MSR and 3,866 th. in OR.

### 3 RESULTS

The results of calculation of efficiency of output-oriented model with constant returns to scale show that out of 12 DMU the only one contract is efficient – for Nový Jičín East (DMU15), the rest of them is inefficient. As for efficiency, contract for Opava area /DMU18) looks good. contrary to it, strongly inefficient is the contract concluded for Frýdlant area /DMU22). The inefficiency field also includes Olomouc SW (DMU2), Litovel (DMU7), Šumperk (DMU10) and Krnov (DMU19). Table 1 shows that the efficiency level is very dispersed. The average unit efficiency of those 24 units is 2.18. The standard deviation for this model with constant returns to scale is 0.7. The results of the output-oriented model with constant returns to scale (OO\_CRS) are shown in Figure 1.

The results of the calculation of efficiency of the output-oriented model with variable returns to scale show that out of 24 DMUs three units are effective, namely in MSR it is Nový Jičín East (DMU3), in OR it is Šternber, Uničov (DMU5) and Prostějov SW (DMU8). A highly inefficient unit as it come to the model with variable returns to scale, the public contracts for the Olomouc SW (DMU2) and for Frýdlant area (DMU22) are. The Table 2 shows that the rate of inefficiency is by both models, CRS and VRS, very dispersed. The average efficiency for this model is 1.93. The standard deviation is 0.673. The results of the output-oriented model with variable returns to scale (OO\_VRS) are shown in the graph in Figure 2.

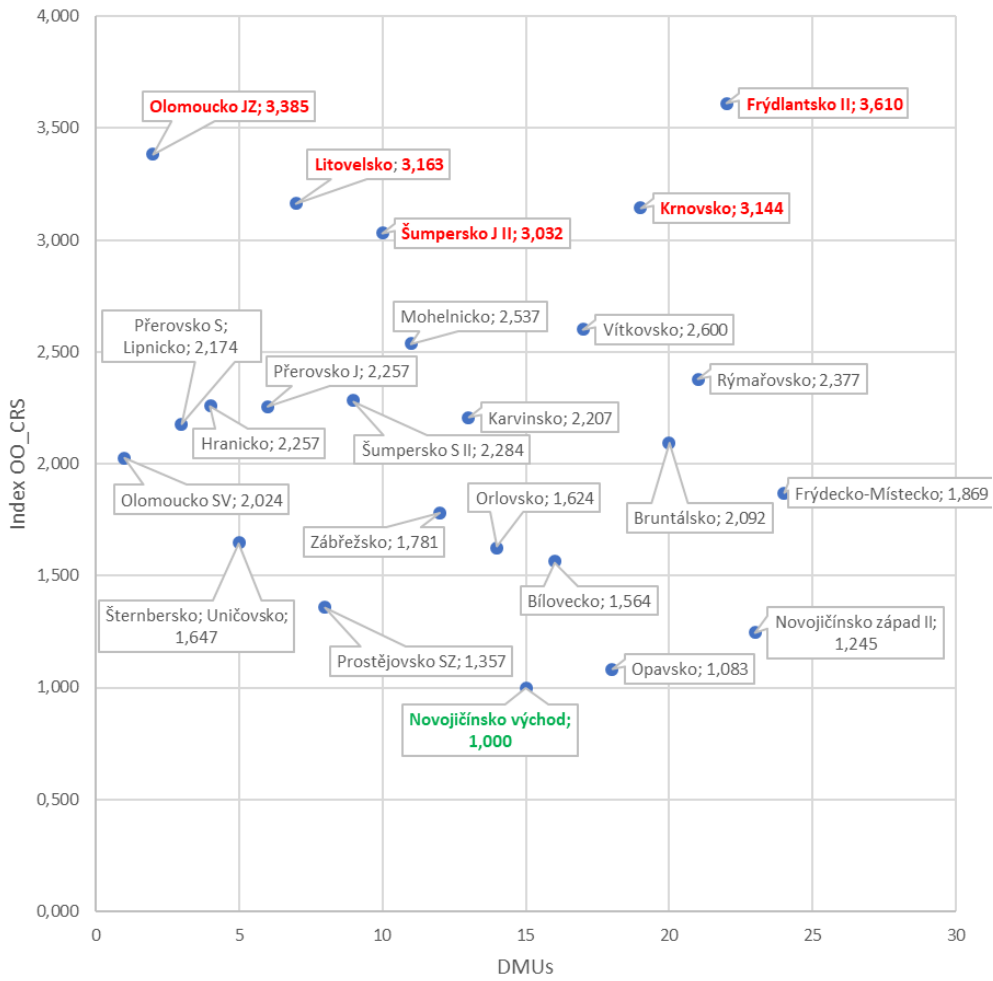

Fig. 1 – Results of the output-oriented model with constant returns to scale (OO\_CRS). Source: own research

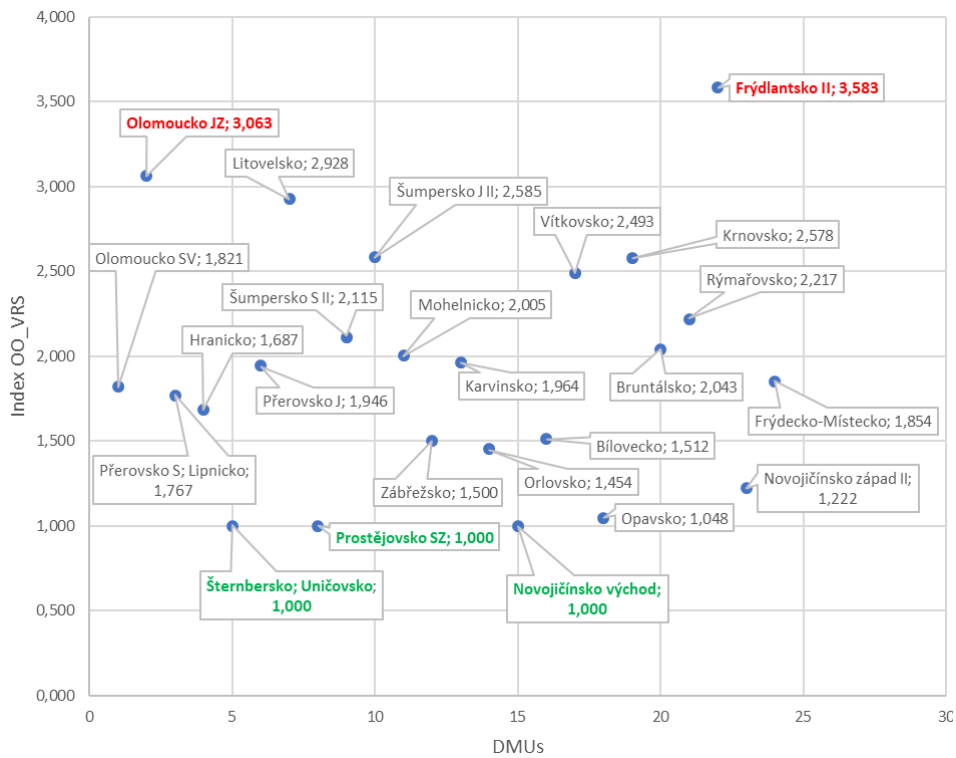

Fig. 2 – Results of the output-oriented model with variable returns to scale (OO\_VRS). Source: own research

A comparative view to the output-oriented CRS and VRS models is presented in Table 2. According to the output-oriented model with constant returns to scale, only the public service contract for the Nový Jičín East area (DMU15) is effectively tendered. Contrary to that, as it comes to the output-oriented model with variable returns to scale, three public contracts are effectively tendered, namely the public procurement for transport service for Šternberk and Uničov (DMU5) and Prostějov NW (DMU8) in OR. As for MSR, there is efficient Nový Jičín east area (DMU15) achieving efficiency in both models. On the other side of the scale, there are inefficient tenders. based on the results of both output-oriented models, contracts for Olomouc SW (DMU2) and Frýdlant (DMU22) are fully inefficient.

According to the output-oriented model with constant returns to scale, public contracts for the Litovel area (DMU7) and Šumperk area (DMU10) in OR are also ineffective. As for MSR, inefficient is Krnov area (DMU19).

Tab. 2 – Summarized results of efficiency modelling of output-oriented model. Source: own research

Scale <i>g</i>	CRS		VRS	
	number	DMU(s)	number	DMU(s)
[1.000]	1	D15	3	D5, D8, D15
[1.001 – 1.499]	3	D8, D18, D23	3	D14, D18, D23
[1.500 – 1.999]	5	D5, D12, D14, D16, D24	8	D1, D3, D4, D6, D12, D13, D16, D24
[2.000 – 2.499]	8	D1, D3, D4, D6, D9, D13, D20, D21	5	D9, D11, D17, D20, D21
[2.500 – 2.999]	2	D11, D17	3	D7, D10, D19
[3.000 + ]	5	D2, D7, D10, D19, D22	2	D2, D22

## 4 CONCLUSION AND DISCUSSION

The issue of public transport efficiency is topical in connection with the growing number of registered passenger cars. The growing number of passenger cars reduces an interest in public transport. Undoubtedly, individual car transport has its advantages such as accessibility, comfort and independence. Nevertheless, public transport has a well-founded place, especially in relation to economic and environmental interests. Since 2010, there has been a steady decline in the number of passengers transported by bus, while the number of passengers transported by rail has been increasing. The Moravian-Silesian Region ranks third behind the South Moravian and Central Bohemian Regions in the number of passengers transported by domestic bus transport within the region. In terms of subsidies granted to the regular public passenger transport, those are continually increasing as it comes to both the regular bus transport (without public transport) and the rail passenger transport. (Yearbook 2017, Ministry of Transport).

The aim of the paper was to evaluate the technical efficiency of 10-year period of suburban bus transport compensation in 12 areas of MSR and 12 areas of OR by chosen inputs and outputs. There were selected 24 public procurements in both regions, in which the contract with the selected carrier was concluded and is fulfilling in the period of 2018 – 2019.

The output-oriented Data Envelopment Analysis model was used to achieve the aim. In the frame of proving the research question RQ1 “Is more than 50% of contracted compensations efficient?” the efficiency calculation showed that in both cases, CRS and VRS, more than 50% of contracted compensations are ineffective. As the second research question RQ2 “What other factors can objectively influence the price of compensation besides chosen outputs – number of connections and vehicle-kilometres?” is considered, only outputs chosen in the model – number of connections and vehicle-kilometres can be assessed objectively. In order to make inefficient public procurement effective, the number of outputs would have to be increased. The required number of connections and the number of vehicle-kilometres is determined by the ordering party. This implies that the ordering party should know how many connections and vehicle-kilometres are needed to ensure the serviceability of the given territory. Thus,



increasing number of outputs could be inefficient in terms of this public service being used by citizens and it would be completely unnecessary for such an increase to occur. The price also reflects the mountainous terrain, number of population or potential passengers, distance of individual stops as well as the size of the managed area.

The results of efficiency achieved by DEA model are limited by both the selection of inputs and outputs and the number of units to be compared (DMU). The results achieved are influenced by efficient and inefficient units. On the one hand in both models, there is very effective public contract for transport service maintaining the Nový Jičín East area, where a contract was concluded with ČSAD Vsetín, a.s. The carrier undertook to provide 43 connections for the price of CZK 37.86 CZK/vkm. A highly inefficient units according to the achieved results, the public contract to serve the territory of Frýdlant and Olomouc SW are. For Frýdlant area, the ordering party (MSR) had to call the tender again. The first published tender procurement had to be cancelled by MSR because the only participant in this procedure exceeded the maximum price per vehicle-kilometre stated in the Tender Documentation. The second tender was also attended by the only one participant, whom the contract was concluded with. The contract included 24 connections for the price of 38.14 CZK/vkm, which is also the highest competed price of all 24 selected public contracts. On the other hand, the lowest price was agreed for the Krnov area (33.57 CZK/vkm).

## References

Act No. 194/2010 Coll., on public passenger transport service, as amended

Act No. 111/1994 Coll., on road transport

Act No. 134/2016 Coll., on public procurement, as amended

Baroch, V., Faifrová, V., Němec, M., Říha, Z., Sliacky, M., & Tichý, J. (2015). *Veřejná doprava v České republice*. Praha: IODA.

Coelli, T. J., Rao, D. S. P., O'Donnell, C. J., & Battese, G. E. (2005). *An Introduction to Efficiency and Productivity Analysis*. New York: Springer.

Cooper, W. W., Seiford, L. M., & Tone, K. (2007). *Data Envelopment Analysis*. New York: Springer.

Dementiev, A. (2018). Contracting out public transport services to vertical partnerships. *Research in Transportation Economics*, (69), 126-134. doi: 10.1016/j.retrec.2018.07.012

Hanauerová, E. (2018). *Optimalizace kritérií veřejných soutěží v hromadné dopravě osob*. Retrieved from [https://is.muni.cz/th/s5nia/Disertacni\\_prace\\_Hanauerova\\_c5oo1.pdf](https://is.muni.cz/th/s5nia/Disertacni_prace_Hanauerova_c5oo1.pdf)

Hanauerová, E. (2019). Assessing the technical efficiency of public procurements in the bus transportation sector in the Czech Republic. *Socio-Economic Planning Sciences*, 66, 105-111. doi: 10.1016/j.seps.2018.07.010

Ivan, I. (2010). Advantage of carpooling in comparison with individual and public transport case study of the Czech Republic. *Geographia Technica*, 9(1), 36-46. Retrieved from <http://search.ebscohost.com/login.aspx?direct=true&db=a9h&AN=52423789&lang=cs&site=eds-live>

Jablonský, J., & Dlouhý, M. (2015). *Modely hodnocení efektivnosti a alokace zdrojů*. Praha: Professional Publishing.

- Kleprlík, J. (2013). Analýza plánů dopravní obslužnosti krajů a návrhy změn plánů dopravní obslužnosti kraje. *Perner's contacts*, 8(3), 69-77. Retrieved from [http://pernerscontacts.upce.cz/31\\_2013/Kleprlik.pdf](http://pernerscontacts.upce.cz/31_2013/Kleprlik.pdf)
- Migliore, M., Burgio, A. L., Maritano, L., Catalano, M., & Zangara, A. (2013). Modelling the accessibility to public local transport to increase the efficiency and effectiveness of the service: The case study of the Roccella area in Palermo. *WIT Transactions on the Built Environment*, 130, 163-173. doi: 10.2495/UT130131
- Ministerstvo Dopravy. (2017). *Ročenka dopravy 2017*. Retrieved from [sydos.cz/cs/rocenka-2017/index.html](http://sydos.cz/cs/rocenka-2017/index.html)
- Moravskoslezský kraj. (2019). *Plán dopravní obslužnosti území Moravskoslezského kraje 2017–2021*. Retrieved from <https://www.msk.cz/cz/doprava/plan-dopravni-obslužnosti-uzemi-moravskoslezskeho-kraje-40792/>
- Národní elektronický nástroj. (2019). *Moravskoslezský kraj - Seznam uzavřených zadávacích postupů*. Retrieved from [nen.nipez.cz/SeznamPlatnychProfiluZadavatele/MultiprofilZakladniUdajeOZadavateliM-20523824/SeznamUzavrenychZadavacichPostupu-20523824](http://nen.nipez.cz/SeznamPlatnychProfiluZadavatele/MultiprofilZakladniUdajeOZadavateliM-20523824/SeznamUzavrenychZadavacichPostupu-20523824)
- Olomoucký kraj. (2019). *Plán dopravní obslužnosti území Olomouckého kraje*. Retrieved from <https://www.kr-olomoucky.cz/plan-dopravni-obslužnosti-uzemi-olomouckeho-kraje-aktuality-632.html>
- Tenderarena. (2019). *Profily zadavatelů*. Olomouc: Tenderarena. Retrieved from <https://www.tenderarena.cz/profil/detail.jsf?identifikator=Olomouckykraj>
- Vrabková, I., & Vaňková, I. (2015). *Evaluation Models of Efficiency and Quality of Bed Care in Hospitals*. Ostrava: VŠB-TUO.

## Contact information

### Ing. Natálie Konečná

VSB – Technical University of Ostrava, Faculty of Economics  
Sokolská třída 33, 70200, Ostrava, Czech Republic  
E-mail: [natalie.konecna@vsb.cz](mailto:natalie.konecna@vsb.cz)  
ORCID: 0000-0002-2464-5191

doi: 10.7441/dokbat.2019.055

# LEX ONDAVKA AS INSUFFICIENT SOLUTION OF THE PROBLEM OF DISINTEGRATION PROCESS OF MUNICIPALITIES AFTER 1989 IN SLOVAKIA

*Gabriel Kopúnek*

## Abstract

The focus of this paper is related to solving the current problem of non-functional small municipalities in Slovakia. The main aim of the thesis is to draw attention to the actual implementation of the new legislative institute in Slovakia - the integration of a non-functional municipality to the neighbouring municipality, which should be the simplest solution to the problem. In order to ensure a positive outcome, the government exempted by law the obligation to hold a local referendum in municipalities which had previously had to be held in a merger in each of the municipalities concerned. The inhabitants of municipalities thus lost their constitutional right to decide on their administration. To create the paper, we chose a case study village Ondavka as one of the methods of qualitative research, in which the affiliation process is to take place as the only and historically first. However, practice to date has shown that this will not be a simple process. Ondavka village has only 15 inhabitants who do not pay local taxes. The municipality's debt to state institutions is at least EUR 27,000, which is much more than the budget of one of the neighbouring municipalities to which Ondavka could affiliate. The second municipality is Becherov, which has a higher budget. However, Ondavka does not want to affiliate the indebted municipality because it plans to draw on euro funds. This paper, in addition to monitoring the affiliation process, also points to another, more effective option to address the problem of dysfunctional municipalities.

*Keywords:* disintegration, non-functioning municipalities, mayor, members of the municipal council, affiliate municipality, Lex Ondavka

## 1 INTRODUCTION

The Latin word 'lex' is synonymous with word 'law' in most European countries and is often used in modern juridical terminology. However, it is also used in the labelling of adopted legislation, that would have to be beneficial, or an innovative element to improve the legal situation in the country. In 2018, the Slovak Parliament passed an amendment to Act No. 369/1990 Coll. on municipal establishment, to resolve a long-term problem of inoperable of small municipalities.

This amendment to Act no. 70/2018 Coll. changed the rules for associate two or more municipalities into one self-governing unit. A new element of the legislation was the affiliate of the municipality to another municipality. Unlike the merger of municipalities, which could only take place after a successful local referendum of the inhabitants of the affected municipalities, in the case of affiliate, the state administration and the authorities of the municipality to which the inoperable municipality is to be affiliated already decide.

The reason for the adoption of the amendment to the Act was the long-term unsolvable situation in Ondavka village, where, since October 2012, no one has been a candidate for self-government authorities. Therefore, the municipality does not perform its tasks under the law. Although the amendment outlined a legislative solution to the problem, but has put more question into practice at the expense of solving the problem. Problems remain despite the fact that the Ondavka affiliation process has already begun. The content of this paper is draw

attention to the causes and purposefulness of the adoption of this amendment to the Act, and also the possible consequences of its application in practice.

## **2 THEORETICAL FRAMING**

Public administration reform has been implemented in Slovakia since 1990 and has been ongoing in various stages to this day. It began with the re-establishment of self-government and the gradual transfer of state competencies to municipalities and towns. The course of the reform of public administration and the related reform of municipal administration are described and summarized in their work by Slavík (2000) and Marišová (2005). In the broader context of decentralization of state administration also Nižňanský (2005), which, besides the historical aspect, dealt with the consolidation and organization of public administration in Slovakia.

The period from 1990 to 2002 is marked by a strong fragmentation of the settlement structure, which, according to Jakabova and Jenča (2012), represents a significant barrier to the completion of the process of decentralization of public administration. The authors attribute this to the issue of sustainability of the further development of small municipalities and fulfilment of self-governing functions. The problem of fragmentation with other European states is compared by Klimovský (2009), which also describes its possible solutions.

One possible solution, according to several theorists, is the consolidation of the situation by merging municipalities. Several scientific studies of Slovak and foreign authors have been published on the pros and cons of this process. Swianiewicz (2010a; 2010b) and Koprić (2012) deal with this controversy as well as the advantages and disadvantages of consolidation and fragmentation. The negative consequences of the merger of municipalities by summarizing the knowledge from professional articles by foreign authors are described, for example, in the work of Ali, Machart and Vimmer (2012). From researches Gajdoš and Moravanská (2013) or Falt'an et al. (2011) shows that the merger of municipalities is negatively evaluated by many representatives of municipal self-government as well as inhabitants of municipalities in Slovakia. As stated by Gajdoš (2015), the merger of small municipalities with larger municipalities in Slovakia has no support. They are more in favour of joining together fulfil certain self-governing functions, while maintaining their autonomy. One possibility, according to Lovacká (2009), could be amalgamation or municipalisation of poorly functional original municipalities into larger units. This would reduce the number of municipalities, save public finances, and improve services for citizen. It would ensure the development of the municipality and also the basic self-governing functions of the municipality. In this process, however, the original municipality would lose its political and administrative autonomy. Such a process has taken place, for example, in Denmark, Belgium or Sweden.

Efforts to maximize the effectiveness of small municipalities by centralizing them into larger units of territorial self-government are facing resistance from municipalities and their inhabitants. Tichý (2005), Nižňanský (2005), Hamalová and Papánková (2005) state that this is mainly due to concerns about the return of the system of central villages from the time of socialism. A sensitive issue of maintaining the autonomous status of municipalities in the process of merging small municipalities or affiliation of an inoperable municipality to a neighbouring municipality it has also become a political and political science topic.

Constitution of the Slovak Republic (Constitutional Act 460/1992 Coll.) defines a municipality as "an independent territorial and administrative unit of the Slovak Republic, associating persons permanent residing in its territory" (Article 64 (2)) and "a legal person who, under the conditions laid down by law, independently manages its own property and its financial resources" (Article 65 (1)). Pursuant to the Constitution of the Slovak Republic, territorial self-government is carried out "at the meetings of the inhabitants of the municipality, by a local

referendum or by the municipal authorities” (Article 67 (1)). The Act of the National Council of the Slovak Republic No. 369/1990 Coll. on municipal establishment talks, that “the municipality decides independently and carries out all acts related to the administration of the municipality and its property” (§ 4 (1)) and that the self-government of the municipality is carried out by the inhabitants of the municipality by the municipal authorities, local referendum and assembly of the inhabitants of the municipality” (§ 4 (2)).

The power to hold a local referendum on the most important issues of the life and development of the municipality and to convene the assembly of the inhabitants of the municipality is it with the municipal council. The Act on Municipal Establishment enumerates in what cases it can do so. In local referendum decides the municipality citizens to merge the municipality with another municipality or city, on the division or dissolution of the municipality, as well as for the change of the name of the village. Given the above-mentioned negative attitude of representatives of self-governments to the merger of municipalities and a legal condition to conduct a local referendum in carrying out this process, the Government of the Slovak Republic decided to amend the Act on Municipal Establishment and thus circumvent the right of citizens of the municipality to decide on the administration of their municipality.

The proposed amendment was intended to establish a mechanism taking into account the democratic principles of territorial self-government, which will enable to resolve cases of long-term non-functioning municipalities, so municipalities are unable to provide basic self-government tasks and activities (Explanatory Memorandum to Act No. 70/2018 Coll. About the municipal establishment 2017). The basic task of each municipality is to provide care for the universal development of its territory and the needs of its inhabitants. The basic issues of the life of the municipality are decided by the municipal council as one of the two bodies of the municipality self-government. The second representative of the municipality and the highest executive body of the municipality is the mayor. It decides in all matters of municipality administration, which are not reserved to the municipal council by the law or the statute of the municipality (Act No. 369/1990 Coll. on municipal establishment). This implies that the municipality is unable to fulfil its basic tasks if both municipalities authorities are not elected or do not work simultaneously. The solution to this situation is the announcement of new elections to self-government authorities, whether it is for the election mayor of the municipality or the election of the missing number of members of the municipal council (Act 180/2014 Coll. The conditions for the exercise of the right to vote).

So that the self-government is not paralyzed, the law on municipal establishment also includes an alternative, if the mayor of the municipality is not elected in ordinary municipal elections. Until the election and promise of the newly elected mayor, performs the duties of mayor acting mayor, because his term of office will expire when he takes the oath of the newly elected mayor. This results in the termination of the mandate within the meaning of § 13a par. 1 of Act no. 369/1990 Coll. on municipal establishment. If the acting mayor of the municipality would not want to continue in this function, may give up the function, and subsequently his competences will be exercised by the deputy mayor (Draškovičová 2018).

However, in rare cases, it happened, that in ordinary or new elections, the inhabitants of the municipality did not apply for the post of mayor or members of the municipal council. This created a situation, when there was no one to act for such a village. The municipality ceased to fulfil one of the essential requirements concerning the status of the municipality under the Constitution. Given that such a dysfunctional municipality cannot even announce a local referendum on a merger with another municipality, amendment to the Act on about the municipal establishment at the institute of affiliation of inoperable municipality entrusted the issuing of consent or disagreement with the affiliation of the municipality in the competence of

the collective body, who is the municipal council of the neighbouring municipality (Explanatory Memorandum to Act No. 70/2018 Coll. on municipal establishment 2017). The amendment thus deprived the constitutional right not only of the inhabitants of a non-functional municipality, but also of the municipality to which the non-functional municipality is to be affiliated.

Theoretically, we can name an inoperable municipality on the basis of the absence of self-government bodies. Existing practice has shown that the problem of choosing representatives for these bodies is predominant in small municipalities. The Slovak authors are inconsistent with the term “small municipality” and for have them municipalities with a population less than 2000 (Pašiak, 2001), or even municipalities with less than 1000 inhabitants (Čavojec & Sloboda, 2005, Neubauerová, 2007, Poliak, 2011), or those with a population of less than 500 (Labunová & Lovacká, 2008). Most authors dealing with the settlement structure of Slovakia refer to “small municipalities” as municipalities with a population of up to 199. This separation is also used by the Statistical Office of the Slovak Republic. In this paper, we will consider the smallest size group of municipalities within this categorization - municipalities in the range of 0-199 inhabitants.

### **3 METHODS**

The submitted paper is based on theoretical knowledge contained in domestic and foreign literature, available in our and university foreign libraries in full-text electronic databases and in electronic resources freely available on the Internet. To create the paper, we chose a case study as one of the methods of qualitative research. The methods of data collection will be their analysis, direct, qualitative observation method, comparison method and detection method. We will use data collection techniques as a study of documents and an unstructured interview.

#### **3.1 Merger and division of municipalities in the Slovak Republic**

After 1989, there was a period of changes not only in the political direction of Czechoslovakia, but also within local government. Constitutional Act 294/1990 Coll. was established as a self-governing community of citizens as the basis of local self-government. Municipality became a public-law corporation with its own property, with its own management and the possibility of collecting taxes and fees as its own income. Citizens were given the right to decide on matters of local self-government at municipal assemblies, by referendum or through the municipal council. Citizens also obtained the right to elect members of the municipal council in general, equal and direct elections. Municipalities also obtained the right to issue generally binding decrees in matters of local self-government, as well as in matters of state administration, if they were authorized to do so by law. Municipalities could associate to secure matters of common interest. The boundaries of the municipality could be changed after a new one only with its consent.

Other important steps for the restoration of local self-government already constitutional law 294/1990 Coll. left to the legislation of individual national councils. National councils set the conditions and manner of establishment, dissolution, division or merger of municipalities, as well as the status, organization and competence of municipalities. It also enacted the conditions for the exercise of the right to vote and the manner in which elections to municipal councils are held, as well as the length of their term of office. In terms of municipal competencies, it determined which things will be considered as self-government matters and in which matters of municipalities will be entrusted with the performance of state administration. This is also the reason why the development of local government in both federal republics was different.

The reform of territorial self-government in Slovakia has been practically continuous since the regime change. Act No. 369/1990 Coll. About the municipal establishment acquired their own legal personality and property, which they could handle independently. Also, powers that they could exercise independently (Mesežnikov & Nižňanský, 2002). However, the Government of the Slovak Republic retained the right to decide on the establishment, dissolution, division or merger of the municipality pursuant to Act 517/1990 Coll. on Territorial and Administrative Division of the Slovak Republic. However, it could only do this with the consent of the municipality, and the inhabitants of the municipality decided to merge, split or dissolve the municipality by voting in a local referendum. The result of the referendum replaced the decision of the municipal council, so the voting of the inhabitants of the municipality had more legal power than the resolution of the municipal council. The voting of the inhabitants of the municipality was valid if an absolute majority of the inhabitants of the village entitled to vote took part in the voting and an absolute majority of the citizens entitled to vote voted for the proposal.

As in the Czech Republic also in Slovakia, municipalities were established by separation from the town or municipality before the adoption of Act No. 369/1990 Coll. The first such village, which was established by the division of Liptovská Teplá as of 1 January 1990, was the new village Ivachnová. Further changes were made on 1 July, 1 August and 1 September 1990. The largest number of newly established municipalities was registered as of November 23, 1990, when the first municipal elections were held in Slovakia. To this day, however, 14 municipalities merged. While on December 31, 1989 there were 2,669 municipalities in the territory of the Slovak Republic, a year later they were already 2,826. Then this number slightly increased by eight new municipalities, but as of 31 December 1991, there were 2,814 municipalities registered in Slovakia (Berčík & Lovecký 2003).

The following municipal elections in 1994 were already held in 2,858 municipalities. Then the disintegration process of municipalities slowed down. Possible continuation of the process of disintegration of municipalities should be limited by the amendment of Act 221/1996 on Territorial and Administrative Arrangement of the SR, which significantly reformed the public administration in Slovakia. The said amendment enacted that the merger of municipalities or division of municipalities is possible only with effect from the date of the general election. The definitive process of disintegration of municipalities has been stopped since 2002 until the amendment of Act No. 369/1990 Coll. About the municipal establishment. Based on this, the municipality can be divided if the new municipalities have a cadastral territory or a set of cadastral territories forming a coherent territorial unit, have at least 3 000 inhabitants and if they have not been urbanized with other parts of the municipality. The municipality cannot be divided if the development of the separated part of the municipality has been invested, on which the whole municipality is dependent.

While the amendment entered into force, another 33 municipalities were established in Slovakia during 1995-2002. At which time and it by the Slovak Government Order in the years 2000 and 2001 nine new municipalities were established and one of them ceased to exist. However, these changes did not come into effect until the date of the municipal elections in 2002 (Berčík & Lovecký 2003). The Government of the Slovak Republic exercised its right to decide on the formation, merger, division or dissolution of the municipality before the municipal elections in 2006, when Act No. 369/1990 Coll. incorporated the renewal of the village Ľubické Kúpele, which was evicted during the establishment of the Military District Javorina and divided the village Kvakovce into the village Kvakovce and the original village Dobrá nad Ondavou.

### **3.2 Different approach to solving problems of dysfunctional municipalities**

The disintegration process after November 1989 caused the formation of a number of municipalities with a population of less than 1,000 in both Republics. Euphoria and the desire for independence, however, brought problems. The most serious thing was that the inhabitants of small municipalities were unable to choose self-governing authorities. While the Constitution of the Czech Republic gave all competence to the municipal council, the Constitution of the Slovak Republic grants different powers to two independent municipal authorities – mayor and council. In the Czech system, the municipal council is the supreme authority of self-government. Its members elect the other elected authorities of the municipality, among them the mayor. The problem arises if a sufficient or minimum number of municipal members has not been elected in ordinary municipal elections. Alternatively, if during the election period the municipal council became inoperative due to the insufficient number of elected members, or it did not sit for more than six months. The self-government municipality thus remained inoperative. The first legislation did not envisage such alternatives. Other or new elections should solve the problem. Act No. 367/1990 Coll. only determined that if the municipal council does not meet for more than six months, it may be dissolved by the Czech National Council on the proposal of the head of the district office after the Government has expressed its opinion.

How many such cases occurred after the municipal elections in 1990 and 1994, the Czech Statistical Office does not register. After the 1998 municipal elections (additional, new, re-implemented), a total of 137 election acts were held in the Czech Republic until the new Act 128/2000 on Municipalities came into force.

Since November 2000, the new legislation has established the function of municipal administrator. Its task was to ensure the exercise of delegated powers from state administration to self-government and ensure the necessary tasks in the ambit of autonomous competence of self-government. Although he could not in some cases replace the performance of the municipal council, however, like the mayor, he managed the municipal office. The administrator of the municipality was appointed by the head of the district office from among the employees of the district office and the administrator of the municipality also be subject to the head of the district office. After the dissolution of district offices, the administrator of the municipality was appointed by the head of the regional office, after the last legislative changes the municipality administrator appoints the Ministry of the Interior among its employees.

At present, the Ministry of the Interior appoints the administrator of the municipality if the elections are not held in the municipality due to the lack of candidates for the members of the municipal council, if the mandate expires for all members of the municipal council and the vacant mandates are not replaced by substitutes, or if the municipalities merge or separate parts of the municipality. The administrator of the municipality represents the municipality externally and its controlling municipal office. Performs statutory tasks in the ambit of autonomous competence and is entitled to lay down rules for the provisional budget of the municipality. The costs associated with the performance of his / her office shall be paid by the Ministry of the Interior.

In the Slovak Republic, the atomization of municipalities caused that part of the newly established municipalities did not know ensure the full functioning of the municipality. It was difficult to find the necessary number of candidates for the position of a member of the municipal council, and later also a candidate for the mayor of the municipality. Such a trend persisted especially in municipalities where the population fell below 30. Between 1991 and 2002, in the event of the termination of the mandate of mayors or deputies of municipal



councils, new elections were held in 64 newly established municipalities. In terms of size, this was in municipalities of up to 199 inhabitants (Berčík & Lovecký 2003).

Unlike the Czech Republic, when amending Act No. 369/1990 Coll. on Municipal Establishment in 2002, the Slovak government did not adopt legislative measures to deal with the problem of functionless municipalities. The decision-making and responsibility were left to the elected representatives of self-governments. Even when it was clear that there was no long-term interest in elected positions in these municipalities. An example is the village Ondavka in the northeast of Slovakia. According to the Statistical Office of the SR as of 31.12.2018, 15 people lived there. Since 1 January 2015, it has no functioning self-governing authorities because the mayor and members of the municipal council have resigned to their elected office. Ondavka Municipal Office ceased to exist on April 15, 2015. Since then, no one has run for elected positions in both ordinary and supplementary elections (Otriová, 2017).

The starting-point of this situation and also the solution for other cases was the adoption of Act No. 70/2018 Coll., Amending and supplementing Act No. 369/1990 Coll. on Municipal Establishment. The new paragraph wording (§ 2aa) allows a non-functional municipality to be affiliated with a neighbouring municipality. The law considers a non-functional municipality to be one in which the municipal authorities not be elected in two consecutive elections. This is, for example, elections to self-governing authorities that are repeated at four-year intervals and following by newly announced new, additional elections. In the case of election of the municipal council members, a sufficient number of members must be elected to enable the council not only to open negotiations but also to adopt resolutions. The Act also stipulates that the Government of the Slovak Republic may, by order, to affiliate non-functional municipality with a neighbouring municipality located in the same district as a non-functional municipality, if the neighbouring municipality agrees. Unlike the process of merging municipalities, there is no need for a local referendum in both municipalities when affiliating the municipality.

The primary purpose of this amendment is to set up a mechanism for accepting the democratic principles of territorial self-government that will enable the long-term problem of non-functioning municipalities to be resolved. Similar to the establishment, dissolution, division or merger of a municipality, in the case of affiliation it is left to the supreme executive body to implement territorial change through a generally binding legal regulation - to affiliate a municipality without authorities to a neighbouring municipality (Kováčová, 2018). The amendment to the Act stipulated that the affiliation process is valid if it is approved by the municipal council of the municipality to which the non-functional municipality is to be affiliated, after the previous public meeting of citizens in both the non-functional municipality and the neighbouring municipality.

In several articles, the Act also determines the tasks of state administration bodies in the process of affiliation of the municipality. We will approach them directly in connection with the case of Ondavka. Since the amendment to the Act on Municipal Establishment came into effect, two successive new elections been held in Slovakia (TASR, 2019a). They were not in Ondavka because no one be running for the mayor or members of the municipal council. The Ministry of the Interior therefore called on the Prešov District Office as a district office in the seat of the region in whose territorial district the non-functioning municipality is located, to convene an assembly of residents of a non-functional village. Assembly in Ondavka July 3rd, 2019, in addition to residents of the village and representatives of the District Office Prešov and representatives of the Public Administration Section of the Ministry of the Interior of the Slovak Republic Mayors of neighbouring villages Becherov, Vyšná Polianka and Nižná Polianka also participated. The meeting was led by Branislav Mičieta, Head of the Administrative, Citizenship and Registries Department of the Prešov District Office. "The assembly was

embarrassedly because the inhabitants of Ondavka were unable to decide which municipality they would like to affiliate. One part of them was for Nižná Polianka, the other part for Becherov. One was unsuitable for traveling to more distant Becherov, the other used to be that Becherov is a larger municipality with a larger budget,” Branislav Mičieta said about the meeting (telephone interview, September 27th 2019).

The next step within the meaning of the amendment of the Act is a written invitation of the district office at the seat of the region addressed to the neighbouring municipality to ensure consent to the affiliation of the non-functional municipality. At the same time, the district office at the seat of the region takes into account the legitimate interests and needs of the inhabitants of the non-functional municipality and in particular to respect a regional or minority language in such a way that such affiliation does not hinder the promotion of that regional or minority language. The neighbouring municipality shall announce its approval or disagreement to the district office at the seat of the region. If the opinion of the municipality is approval, the district office at the seat of the region will submit to the Ministry a proposal to associate the non-functional municipality with the neighbouring municipality. Its annexed is a record of the assembly of residents of a non-functional village and document of consent of the neighbouring municipality with to affiliation of the non-functional municipality. The non-functional municipality is expired by to affiliation and the neighbouring municipality is the legal successor of the non-functional municipality.

If the opinion is negative, the district office will call in writing to the next neighbouring municipality for assent. However, this alternative is only possible if a non-functional municipality has several neighbouring municipalities. If it has only one neighbouring municipality and it does not agree with the affiliation, the whole process ends and to affiliation of the municipality does not occur. The law speaks of the possibility to affiliate of the municipality and not of the obligation. “The amended law talks about the possibility of the government by ordering to associate a non-functional municipality with neighboring municipalities. In this context, therefore, it is not an obligation, which implies that the process may not result in affiliation of a non-functional municipality with a neighbouring municipality, thereby is loses its substance (Kováčová 2018).

There is a preliminary interest to affiliate Ondavka to the village of Becherov. Negotiations of the municipal council in Becherov regarding to affiliate of Ondavka to the village have not yet taken place. According to Branislav Mičieta, however, this is prevented by the poor financial situation of Ondavka. The municipality has debts for poor management and does not own any property. “We are currently investigating all the debts of Ondavka. Meanwhile, we know about distraintment of € 27,000. As the annual budget of Vyšná Polianka amounts to EUR 20,000, this municipality is out of the affiliation process. Becherov has a much higher budget, but unless Ondavka's debt is reduced or settled, it is premature to talk about affiliation on its part. Until 2020, municipalities can draw on Eurofunds, and they cannot be applied for by a municipality with execution. Since the debt is mostly made up of fines and penalties from the Social Insurance Agency, the General Health Insurance Company and the Tax office, the Ministry of the Interior could claim forgiveness and penalties with these institutions, and thus help the course of affiliation of Ondavka to the neighbouring village,” said Branislav Mičieta (telephone interview, September 27th 2019).

The possibility of providing a one-off financial contribution from the budget of the Ministry of the Interior to support the smooth performance of self-government of the municipality does not alleviate the fear of the transfer of distrains from Ondavka to Becherov. There is no legal entitlement to the subsidy and the entire approval process can take up to three months. Moreover, the amount of the subsidy provided is assessed through the population criterion - the

number of inhabitants of the municipality and its size after the inclusion of a non-functional municipality.

#### **4 DISCUSSION AND CONCLUSIONS**

The disintegration process of municipalities after the end of the totalitarian regime in Czechoslovakia in the spirit of post-November euphoria took an uncontrollable dimension. While both national councils adopted the corresponding legislation relating to municipal self-government, dozens of municipalities with to 199 inhabitants were established. They gradually had a problem elect to municipal authorities.

Until the adoption of Act No. 70/2018 Coll., it was only possible to solve the problem of non-functioning small municipalities by merging municipalities. However, this process was complicated by the condition of a local referendum in both municipalities concerned by the merger. Thus, referendum legislation with a strictly determined double absolute majority (more than half of the eligible voters had to participate in the referendum and an absolute majority of them had to agree to the merger) thus completely stopped the process. Merging of municipalities could only be realized in those municipalities that were really interested in it.

The adoption of Act No. 70/2018 Coll., which came into force on April 1, 2018, should provide a mechanism for solving the situation of small municipalities, who are incapable of performing or performing basic self-government tasks, because they do not have elected municipal authorities. The only such municipality in Slovakia is Ondavka, where elections to municipal authorities have not been held since 2010. As stated in the explanatory memorandum to the adoption of Act No. 70/2018 Coll., in the next three years it is supposed to use the institute of affiliation of the municipality only in one case, which is Ondavka municipality. That is why we called this law "Lex Ondavka".

It is clear that the government has decided to tackle this problem vigorously, removing citizens' constitutional right to decide autonomously and freely about their administration. On the other hand, the municipality to which the non-functional municipality is to be affiliated does not instruct the law to do so. The affiliation process leaves to the municipal council, to elected by citizens. This creates pressure on members of the municipal council to either decide for the benefit of the state and against the will of citizens, or vice versa. Although it is a free decision, we do not consider it to be a democratic one because municipalities are dependent on state subsidies. In the case of the municipalities of Ondavka and Becherov, especially because Ondavka is indebted by distraintment from state organizations. It is therefore likely that the state will no longer claim its claims against Ondavka, or to give the municipality of Becherov subsidies to pay the claims of Ondavka later, which can be considered an uneconomical solution or corruption. Otherwise, it is pointless to associate a village without property, with 15 inhabitants who refuse to pay local taxes and with 27 executions (TASR, 2019b). However, if the whole process is not to culminate in affiliation of a non-functional municipality to functional self-government, the meaning of the entire amendment to the Act disappears. In the following period it is important to closely monitor further steps of the state administration in solving the problem of Ondavka village. Moreover, even when the government that drafted the amendment does not believe that Ondavka to affiliate in Becherov. In Ondavka on 4 April 2020, the President of Parliament announced new elections to the mayor and members of the municipal council.

It was enough to take the example from the Czech Republic, where since 2000, the new legislation has established the function of municipal administrator. Its task was to ensure the exercise of delegated powers from state administration to self-government and ensure the necessary tasks in the ambit of autonomous competence of self-government.

## References

- Act No. 369/1990 Coll. (Zákon 369/1990 Zb. o obecnom zriadení)
- Act No. 460/1992 Coll. (Zákon 460/1992 Zb. Ústava Slovenskej republiky)
- Act No. 294/1990 Coll. (Zákon č. 294/1990 Sb., kterým se mění a doplňuje ústavní zákon č. 100/1960 Sb., Ústava Československé socialistické republiky, a ústavní zákon č. 143/1968 Sb., o československé federaci, a kterým se zkracuje volební období národních výborů)
- Act No. 367/1990 Coll. (Zákon č. 367/1990 Sb. Zákon České národní rady o obcích)
- Act No. 128/2000 Coll. (Zákon č. 128/2000 Sb. Zákon o obcích)
- Act No. 517/1990 Coll. (Zákon č. 517/1990 Zb. o územnom a správnom členení Slovenskej republiky)
- Act No. 70/2018 Coll. (Zákon 70/2018 Z. z., ktorým sa mení a dopĺňa zákon Slovenskej národnej rady č. 369/1990 Zb. o obecnom zriadení v znení neskorších predpisov)
- Belajová, A., & Balážová, E. (2004). *Ekonomika a manažment územnej samosprávy*. SPU Nitra
- Berčík, P., & Lovecký, P. (2003). *Územné zmeny obcí v SR od roku 1990*. Bratislava: Sekcia verejnej správy Ministerstva vnútra SR.
- Čavojec, J., & Sloboda, D. (2005). *Fiškálna decentralizácia a obce*. Retrieved from [http://www.konzervativizmus.sk/upload/pdf/fisk\\_dec.pdf](http://www.konzervativizmus.sk/upload/pdf/fisk_dec.pdf)
- Draškovičová, M. (2018). *Postup obce po voľbách bez kandidáta na starostu*. Retrieved from [http://www.isamosprava.sk/Volby\\_Starosta\\_Postup\\_obce\\_po\\_volbach\\_bez\\_kandidata\\_na\\_starostu](http://www.isamosprava.sk/Volby_Starosta_Postup_obce_po_volbach_bez_kandidata_na_starostu)
- Falt'an, L., Strussová, M., Kostl'an, D., Falt'anová, L., & Sopiřová, A. (2011). *Malé vidiecke sídla na Slovensku začiatkom 21. storočia*. Bratislava: Sociologický ústav SAV.
- Gajdoš, P., Moravanská, K. (2013). *Problémy a možnosti sídelného vývoja na Slovensku z pohľadu predstaviteľov obcí*. Bratislava: Sociologický ústav SAV.
- Gajdoš, P. (2015). *Ako sa mení vidiek na Slovensku*. Bratislava: Sociologický ústav SAV
- Hampl, M., & Müller, J. (1998). Jsou obce v České republice příliš malé? *Sborník České geografické společnosti*, 1(103), 1-12. Retrieved from [https://www.researchgate.net/publication/272021577\\_JSOU\\_OBCE\\_V\\_CESKE\\_REPUBLICKE\\_PRILIS\\_MALE/link/54d8d5570cf2970e4e79bb81/download](https://www.researchgate.net/publication/272021577_JSOU_OBCE_V_CESKE_REPUBLICKE_PRILIS_MALE/link/54d8d5570cf2970e4e79bb81/download)
- Hamalová, M., & Papánková, S. (2005). K aktuálnym problémom komunálnej reformy v SR. In E. Žárska & M. Šebová (Eds.), *Decentralizácia verejnej správy Slovenskej republiky: otvorené otázky*. Bratislava: Ekonomická univerzita v Bratislave.
- Jakabová, Z., & Jenčo, M. (2012). Fragmentácia sídelnej štruktúry Slovenska s dôrazom na problematiku malých obcí. In: *Region v rozvoji spoločnosti 2012: sborník príspevků z mezinárodní vědecké conference*. Brno: Mendelova univerzita.
- Klimovský, D. (2009). O možných riešeniach fragmentovanej lokálnej sídelnej štruktúry. *Acta Politologica*, 1(2), 182-213. Retrieved from [https://www.researchgate.net/publication/236839432\\_O\\_moznych\\_rieseniach\\_fragmentovanej\\_lokalnej\\_sidelnej\\_struktury](https://www.researchgate.net/publication/236839432_O_moznych_rieseniach_fragmentovanej_lokalnej_sidelnej_struktury)

- Koprić, I. (2012). Consolidation, Fragmentation, and Special Statuses of Local Authorities in Europe. *Croatian and comparative public administration*, 12(4), 1175-1196. Retrieved from <https://hrcak.srce.hr/130492>
- Kováčová, S. (2018). Nefunkčná obec ako predpoklad územnej konsolidácie. Retrieved from [e-polis.cz/clanek/nefunkcna-obec-ako-predpoklad-uzemnej-konsolidacie.html](https://e-polis.cz/clanek/nefunkcna-obec-ako-predpoklad-uzemnej-konsolidacie.html)
- Lovacká, S. (2009). Geografické aspekty komunálnej reformy v Slovenskej republike. *Geographia Cassoviensis*, 3(1). Retrieved from [https://geografia.science.upjs.sk/images/geographia\\_cassoviensis/articles/GC-2009-3-1/ABB\\_Lovacka\\_2009.pdf](https://geografia.science.upjs.sk/images/geographia_cassoviensis/articles/GC-2009-3-1/ABB_Lovacka_2009.pdf)
- Mesežnikov, G., & Nižňanský, V. (2002). Reforma verejnej správy na Slovensku 1998-2002. *Stredoevropské politické studie*, 4(4). Retrieved from <https://journals.muni.cz/cepsr/article/view/3930>
- Otriová, J. (2017). *Ondavka je slovenskou raritou. Nemá starostu ani poslancov*. Retrieved from <https://presov.korzar.sme.sk/c/20677988/ondavka-je-slovenskou-raritou-nema-starostu-ani-poslancov.html>
- Swianiewicz, P. (2010a). If Territorial Fragmentation is a Problem, is Amalgamation a Solution? An East European Perspective. *Local Government Studies*, 36(2), 183-203. doi: 10.1080/03003930903560547
- Swianiewicz, P. (2010b). *Territorial consolidation reforms in Europe*. Local Government and Public Service Reform Initiative.
- TASR. (2019a). *Doplňujúce voľby budú 21. septembra v 24 obciach*. Retrieved from <https://www.hlavnespravy.sk/doplnujuce-volby-budu-21-septembra-24-obciach/1870974>
- TASR. (2019b). *Obec má 27 exekúcií, pracuje sa na znížení dlhu*. Retrieved from <https://presov.korzar.sme.sk/c/22202877/obec-ondavka-ma-27-exekucii-pracuje-sa-na-znizeni-dlhu.html>
- Tichý, D. (2005). Združovanie obcí ako predpoklad rýchlejšieho rozvoja samospráv a regiónov. *Ekonomický časopis*, 53(4), 364-382. Retrieved from [http://www.angelfire.com/pro2/dusan\\_tichy/PDF/EC405.pdf](http://www.angelfire.com/pro2/dusan_tichy/PDF/EC405.pdf)

## Contact information

### PhDr. Gabriel Kopúnek

University of Ss. Cyril and Methodius in Trnava, Faculty of Social Sciences  
 Bučianska 4/A, 91701, Trnava, Slovak Republic  
 E-mail: [Gabriel.kopunek@gmail.com](mailto:Gabriel.kopunek@gmail.com)  
 ORCID: 0000-0002-2617-5891

doi: 10.7441/dokbat.2019.056

# SPECIFICS OF NEUROMARKETING AND ITS APPLICATION ON FRAGILE TARGET GROUP CHILDREN

*Denisa Kral'ovičová*

## **Abstract**

Neuromarketing is newly emerging discipline that links neuroscience with consumer behaviour. It is an interdisciplinary branch that is predicated on the use of neuroscientific concepts, methods and theories to study nervous system and the brain due to understand instinctive human behaviour in terms of emotions and cognitions, both, conscious and unconscious, in response to marketing stimulus. It is very juicy topic these days and is used as a pretty influential marketing tool. This article aims to focus readers' attention on this topic as well as stimulates discussion dealing with traditional and new methods of research. It adopts an integrated knowledge dealing with theoretical and practical neuromarketing, explains its concept, methods used in real life, target group children as well as related ethical issues and discusses the future role of neuromarketing as providing some new impulses for marketers in terms of customer behaviour. The practical dimension of this paper is made by its necessity to be used in the companies by indicating some examples of real-life studies dealing with neuromarketing generally as well as some examples focusing on target group children. It tends to clarify the key questions dealing with neuromarketing research and studies in a theoretical way. Thus the article should assist as a starting point for future research dealing with neuromarketing in university background in Slovakia.

*Keywords: black box, brain, emotions, neuromarketing, research, target group children*

## **1 INTRODUCTION**

In essence, the goal of neuromarketing is to adapt theories and methods from neuroscience and combine them with theories and methods from marketing and related disciplines, such as economics and psychology, to develop neuroscientifically sound explanations of the impact of marketing on target customer behaviour (Lim, 2018).

The aim of marketing is to define customer needs, wishes and desires as precisely as possible, and design products that would perfectly satisfy those needs and wishes. Customers frequently do not know exactly what sort of product they would prefer and marketers often do not know the exact way of communication with the customers. Understanding of consumers' behaviour is not a simple task, several of their wishes and desires are made sub-consciously, neuroscience has shown that Homo Economicus theory for decision making is incorrect and emotions, heuristic and other aspects have great influence on new decision making model. Nowadays, however, classical methods of marketing research are not enough for their exact determination. So neuromarketing appears to be a very useful way of solving this problem.

This paper aims to demystify neuromarketing as such by explaining its concept, terms and methods used in practice. Its partial aim is pointing at the target group of children as a very sensitive one, so very interesting for the marketers to focus on. Following these, the structure of this paper focuses on two main areas such as neuromarketing and neuromarketing focusing on children. The theoretical background dealing with neuromarketing deals with some specific definitions, various authors, different points of view and division of NM into theoretical and applied one. It focuses on neuromarketing research as such, NM and its use in practice. It also deals with methodology of NM studies, some basic principles of neuromarketing research,

studies and their real-world takeaways have been described in this part. Finally, some practical examples of studies dealing with NM generally and NM focusing on children will appear, while describing the target group children as a very sensitive one, very interesting for the marketers to focus on, so easily to be misused for the marketing purposes. The question of ethics arises in this connection. It will be noticed later on in the paper. Even though the article is more theoretical than practical, it deals with some crucial areas dealing with neuromarketing. It is necessary to deal with it as a starting point for further research in this field. Concerning methodology of this paper, search for some high quality papers dealing with this topic has been made, three sources have been checked - Web of Science databases, Google scholar and Scopus. The print books dealing with psychology, marketing and neuromarketing have also been used.

## **2 NEUROMARKETING IN THEORY**

Neuromarketing is a commercial marketing communication field that applies neuropsychology to marketing research, studying consumers' sensorimotor, cognitive, and affective response to marketing stimuli (Lee, Broderick & Chamberlain, 2007).

Neuromarketing is an interdisciplinary product of neuroscience and marketing. The concept was first coined and referred to by Ale Smidts in 2002 as "the study of cerebral mechanism to understand consumer behaviour in order to improve marketing strategies" (Boricean, 2009).

Later, various definitions of this term developed. Some scholars viewed neuromarketing as "the application of neuroscientific methods to analyse and understand human behaviour in relation to markets and marketing exchanges" (Lee, Broderick & Chamberlain, 2007), while others defined it as "field that focuses on the marketing implications from understanding the interaction of conditions and emotions in human behaviour based on neuroscientific methods" (Javor et al., 2013).

Various neuromarketing scholars (Butler, 2008; Garcia & Saad, 2008; Lee, Broderick & Chamberlain, 2007) have published conceptual and review (Cruz et al., 2016) articles. However, few studies have rigorously produced empirical findings on the topic (Costa, de Freitas & Paiva, 2015) and even fewer have appeared in the main academic outlets for marketing science (e.g. Journal of marketing, Journal of marketing research, Marketing Science) (Lim, 2018). That's partly why this article is more a kind of review but not research itself.

There are two different types of neuromarketing, theoretical NM and applied NM, depending on how the knowledge and tools are applied. When applying neuroscience knowledge to the area of marketing, this is theoretical marketing (consumer neuroscience) and when applying neuroscience research methods and tools (EEG, biosensors, ET etc.) to carry out market research, it is called applied neuromarketing (neuroresearch). (BitBrain, 2009)

By researching the brain and mind of consumer, it can uncover the consumers' needs, opinions on the product, advertising or brand. If he fancies it or not, if so, to which extent etc. Neuromarketing tries to understand logical rational origin behind consumers' behaviour, when making e.g. purchasing decisions and their responses to marketing stimuli (Touhami et al., 2011). It helps marketers to improve their campaigns and strategies due to rise their profits. Especially large-scale companies invested a lots of finances to their own laboratories due to predict consumers' purchasing behaviour. What is a key factor for neuromarketing these days is just co-operation between the scientific and business spheres, both sites having profit from this co-operation (Burgos-Campero & Vargas-Hernandez, 2013). Entrepreneurs will provide research funding with commercial interests and scientific activity can move forward more quickly. Despite the fact that science has already brought some knowledge about consumer

purchasing behaviour, it is still difficult to predict this thinking. Black box model perfectly points to the consumer's mind when making decisions. Endogenous and exogenous factors enter the process first and affect the consumer. They then go through and are processed by the black box of the consumer (mind) and bring the final reaction of the consumer. Koudelka (2006) describes the black box as inner world, in which later decisions are made.

Regarding theoretical marketing (consumer neuroscience), as well as applied neuromarketing (neuroresearch), there are various advantages and challenges dealing with both of these types. Theoretical marketing helps us to understand our emotions much better. Regarding psychological point of view, if we want to understand the role of different senses that influence our behaviour, we are talking about visual NM, auditory NM, sensory NM, olfactory NM etc. One of the reasons why traditional marketers are interested in neuromarketing is their home to find a sort of „instruction manual“ to predict consumers' behaviour, so they can manipulate with their minds. The point is that nowadays, it is impossible to model our behaviour 100% or even manipulate it. So theoretical NM cannot offer any „instruction manual“. Many experts try to generalize the results of studies, so they make a mistake, as it is impossible. Many studies are carried out in specific environment, for specific purposes, with a specific product type etc., so it is impossible to generalize it. What is more, the question of ethics appears in connection of theoretical NM too.

## **2.1 Neuromarketing research**

Many experts try to substitute traditional research techniques, but neuromarketing does not have any substitutive role. The best results are reached by combining traditional research techniques with NM. There are some difficulties dealing with NM research. It is often simplified and some of the aspects, which must be taken into consideration are as follows: (a) high quality technology - it is necessary; (b) right experimental design - it is needed to follow correct scientific methodology and avoid experimental biases; (c) right decoding algorithms - it is necessary to employ calibration techniques and models to individualize the decoding algorithms such as BitBrain's laboratories; and (d) experience dealing with interpretation of results – good interpretation of results (BitBrain, 2009).

As mentioned earlier, there are various techniques used in applied NM e.g. EEG (brain activity), biosensors – GSR (galvanic skin response) and BVP (heart rate), eye-tracking, IRT etc. There are various conferences dealing with this topic too. The brain maps is considered to be an answer to the process of measuring psychological changes produced due to any emotional and cognitive behaviour. In other words, psychological signals are translated into metrics and valuable information are demonstrated by the brain maps. Calibration stimuli are shown later on.

## **3 NEUROMARKETING IN PRACTICE**

It is necessary to provide more practical information dealing with carrying out a neuromarketing study, most common applications of NM and reasons for companies to use and offer NM nowadays. It is also needed pointing out various practical studies, while dealing with one of them much more in details.

### **3.1 Methodology of NM studies**

As it comes to carrying out neuromarketing study, it is not only about placing the technology on a participant and showing the stimulus we want to evaluate, waiting for his emotions. The steps required are as follows: (1) briefing with the participant - understand the objectives of participant, designing a study; (2) defining the sample to be included - type of sample depends



on briefing, ideally at least 40 people should be included; (3) technologies to be included - depends on briefing too, obtaining the metrics, while using high-tech quality technologies; (4) design of experimental protocol - many questions to be included; (5) organizing and executing field work - ideally 40-person sample per week, leaving some time to recruitment, implementation and evaluation of the study, including small pilot study with 2-3 people; (6) obtaining metrics - taking NM context into consideration, selecting suitable laboratory etc.; and (7) interpreting the results - difficult step, includes ability to extract valuable insights from the metrics obtained and answer the questions from the briefing etc.

### **3.2 Neuromarketing and its use in real life**

There are various common applications, which are used in applied NM as branding, product/pack, publicity, digital surrounding etc. There are more and more companies, which fancy and use NM these days, which can be classified to three groups: companies, which use NM, companies that offer NM services and companies that sell technology and NM laboratories.

Companies which use NM - these are mainly B2C companies of a medium-large size, which are familiar with carrying out traditional market research and want to complement the results with emotional and cognitive (non-conscious) information from the participants. They sometimes require their own laboratories, but the common practice is use traditional research institutions.

Companies that offer NM services - these include traditional market user experience companies that complement their portfolio with these studies, special companies that offer exclusively this type of service, other types such as e.g. communication companies, design studios, publicity agencies etc. Companies that sell technology and NM laboratories - companies that sell devices for clinical use and companies that sell user-friendly NM laboratories, which can be utilized by non-experts.

Regarding various practical studies dealing with NM research, it is worth to be noticed the following ones and focus on one much more in details. All were published in 2016-2018 and reveal potential of NM. All of them illustrate, both, conscious and subconscious systems and its conflicting interpretation. These studies try to answer the following questions: „Which is better predictor on purchasing behaviour - qualitative research of fMRI scans? Can NM studies of individuals predict mass behaviour? Does audio or video content generate more user engagement? How does qualitative data on willingness to pay (WTP) compare to neuroscience data? How does the level of risk affect customer data? Do different payment options make users more or less confident? Which design elements make an online story trustworthy? Does a potential loss or gain make a product seem more valuable? Can you add a message to your CAPTCHA to influence user behaviour? Which platform-website, social media or 3th party review site - has the „stickiest“ adds? ” (Greason, 2019).

Our attention will also be focused on the study called When Brain Beats Behaviour? Neuroforecasting Crowdfunding Outcomes. Genevsky, Yoon and Knutson (2017) used the crowdfunding site Kickstarter due to test if neural activity would forecast market level crowdfunding outcomes weeks later. The main question of this study was if NM studies of individuals can predict mass behaviour. Regarding this study, 30 subjects were showed 36 crowdfunding requests. “Subjects decided whether they would fund each project, with real money taken from their study compensation for projects they supported” (Greason, 2019). Researchers recorded subject’s brain activity. After that, the subjects rated their opinions dealing with each project (positive or negative) etc. A few weeks later, the researchers

compared these ratings and brain activity dealing with crowdfunding projects. It has shown that brain activity was the only one successful predictor of crowdfunding outcomes.

## **4 NEUROMARKETING FOCUSING ON CHILDREN**

The purpose of this part is not to describe each and every stage in details, it is to describe some specifics of children as a target group for the marketers and show their sensitivity. There are four key factors, which influence children: family, school, free time and values. There are more facts, which are closely connected with four key factors as well. According to Kotler (2012), these are as follows: cultural, social, personal, psychological and buying factors.

### **4.1 Children as target group**

Practically, children in the family are involved in the purchase of any household products and services; in the transferred meaning, they have the most important word. Sellers divide children as a market segment into three types (McNeal, 2010): (a) children as primary market - children, who have the ability to manage their own money (pocket money) and decide on their use; (b) children as secondary market - products and services are purchased by parents, who are influenced by demands, needs and wishes of children, when choosing the goods and services; and (c) children as potential market - traders and marketers have been trying to build relationships, build their affection and loyalty to their brand from a child's age in the future shopping decision.

Child consumers are very special and sensitive consumer groups, their purchasing behaviour is mainly driven by emotional nature. They are very naive and not skilled enough, so they become an easy victim for traders and marketers. According to Vysekalová et al. (2014), there are three groups dealing with purchasing behaviour of children according to age, which are as follows: (a) preschool child consumer - at this age his product preferences are based on what his friends have or what they saw in the ad (products which purchase significantly affect children - dairy products, toys, sweets, books and others); (b) child consumer up to 12 years of age - this age period is called a social identity stage, where a child among peers seeks his place and position. This period is very sensitive as children have been reaching their social position. Such sorting may occur, for example, based on branded clothing ownership, the latest mobile phone, or pocket money (products which purchase significantly affect children - all the above mentioned goods in preschool age plus mobile phones, notebooks and play stations); and (c) child consumer from 13-18 - their purchasing behaviour is influenced by their ideals, they derive values and preferences from them. In this life phase, they are the most adventurous target audience of advertising, profiling their first consumer habits and brand loyalty (products which purchase significantly affect - modern clothes, cosmetics, mobile phones, PC, tablet etc.).

Last, but not least, it is important to notice Alpha generation children (Millennials) at this point. These are children born between 2010 and 2025. They are very natural in terms of using smart phones and other technically sophisticated equipment and therefore it is considered to be the most advanced generation in digital skills (Vágnerová, 2017). It is also expected to be the richest and most advanced generation to present. Being online is no longer an option, it is a must. We live in the digital age and our needs become digitalized, too (Hubinová, 2017).

### **4.2 Practice**

Regarding neuromarketing and children, it is needed to emphasize the role of emotions one more time as having strong effect on how consumers process images and understand messages in ads. Many companies like Google, Disney, and CBS etc. have used NM to advertise. If the marketers want to be successful, they need to target the emotional brain first, then the primitive brain to

open the channel of attention and the information is transmitted to the rational brain. Children between 7 and 12 years do not have cognitive and analytical skills so they are not able to process advertisements as marketers attempt to. This may lead to intended or unintended enhanced advertising effects. As it comes to intended effects researchers from Ahlia University, Bahrain- Amani Al Abas and his supervisors, came up with three intended effects - cognitive effect, affective effect, behavioural effect. Regarding unintended effects, these are as follows: parent-child conflict, unhealthy eating habits, frustration, and materialism. They intended to use quantitative method, used questionnaires, which were distributed to parents of children aged between 7 and 12 years, sample size 500. The purpose of this study was to put the light on both factors and find which of these factors has more power.

## 5 DISCUSSION

Summing up the previous points, the attention was focused on some basic principles of NM. As it comes to use of traditional and NM techniques in practice, we came up to conclusion that mix of both is the best for making a high quality research/study, while following some basic principles described. Neuromarketing is and will be a very challenging scientific field in future as it became a very practical tool for the marketers and big companies to define the customers' needs and wishes to improve communication due to tailor-made their goods and services and improve their profit. Of course the question of ethics arises here. Where are the borders of gaining the knowledge about the brain, what else is hidden in the black box? How to predict customers purchasing behaviour?

## 6 CONCLUSION

Despite the limitations of the paper, absence of empirical data and analysis, the best effort has been taken to propose an objective opinion dealing with neuromarketing, its frontiers and limitations. As the article itself does not focus on any detailed examination of research, its theoretical basis offers a good starting-point for future research to be made in this field. Following the previous points, there are various areas to focus on in future in terms of research such as: academic efficacy of neuroscience measurement techniques in advancing marketing theory (there is lack of it), ethical concerns with using these techniques (question of ethics appears constantly as the connection of neuromarketing focusing on children and marketing efforts to profit for any price are considered to be on the edge of ethics), education for academics, who deal with this topic (there is a lack of it in Slovakia) etc. So these are the topics for another discussion and other paper to be written much more in details.

### References

- BitBrain (2009). *All you need to know about neuromarketing*. Retrieved from <https://www.bitbrain.com/blog/what-is-neuromarketing>
- Boricean, V. (2009). *Brief history of neuromarketing*. Paper presented at the International Conference on Economics and Administration (ICEA-FAA). Romania: University of Bucharest. Retrieved from <https://www.scribd.com/document/61941611/Brief-History-of-Neuromarketing>
- Burgos-Campero, A. A., & Vargas-Hernandez, J. G. (2013). Analytical Approach to Neuromarketing as a Business Strategy. *Procedia - Social and Behavioral Sciences*, 99, 517-525. doi: 10.1016/j.sbspro.2013.10.521

- Butler, M. J. R. (2008). Neuromarketing and the perception of knowledge. *Neuromarketing*, 7(4-5), 415-419. doi: 10.1002/cb.260
- Costa, J. V., de Freitas, C. L., & Paiva, T. (2015). Brain imaging during advertising: A neuromarketing study of sound and pictures. *Marketing Review*, 15(4), 405-422. doi: 10.1362/146934715X1450349053594
- Cruz, C. M. L., de Medeiros, J. F., Hermes, L. C. R., Marcon, A., & Marcon, E. (2016). Neuromarketing and the advances in the consumer behaviour studies: a systematic review of the literature. *International Journal of Business and Globalisation*, 17(3), 330-351. doi: 10.1504/IJBG.2016.078842
- Garcia, J. R., & Saad, G. (2008). Evolutionary neuromarketing: darwinizing the neuroimaging paradigm for consumer behavior. *Neuromarketing*, 7(4-5), 397-414, doi: 10.1002/cb.259
- Genevsky, A., Yoon, C., & Knutson, B. (2017). When Brain Beats Behavior: Neuroforecasting Crowdfunding Outcomes. *Journal of Neuroscience*, 37(36), 8625-8634. doi: 10.1523/JNEUROSCI.1633-16.2017
- Greason, D. (2018). *10 recent neuromarketing research studies (and their real-world takeaways)*. Retrieved from <https://conversionxl.com/blog/neuromarketing-research/>
- Hubinová, J. (2017). Social media in university education process. *European Journal of Science and Theology*, 13(6), 229-238. Retrieved from [https://www.researchgate.net/publication/321666237\\_Social\\_media\\_in\\_university\\_education\\_process](https://www.researchgate.net/publication/321666237_Social_media_in_university_education_process)
- Javor, A., Koller, M., Lee, N., Chamberlain, L., & Ransmayr, G. (2013). Neuromarketing and consumer neuroscience: contributions to neurology. *BMC Neurology*, 13(13), 1-12. doi: 10.1186/1471-2377-13-13
- Kotler, P. (2012). *Kotler on Marketing*. New York: Free Press.
- Koudelka, J. (2006). *Spotřební chování a segmentace trhu*. Praha: VŠEM.
- Lee, N., & Broderick, A. J., & Chamberlain, L. (2007). What is "neuromarketing"? A discussion and agenda for future research. *International Journal of Psychophysiology*, 63(2), 199-204. doi: 10.1016/j.ijpsycho.2006.03.007
- Lim, M. W. (2018). Demystifying neuromarketing. *Journal of Business Research*, 91, 205-220. doi: 10.1016/j.jbusres.2018.05.036
- McNeal, J. U. (2010). *Children as consumers of commercial and social products*. Washington: Pan American Health Organization. Retrieved from <http://www1.paho.org/hq/dmdocuments/2010/Los-ninos-como-consumidores-productos-sociales-y-comerciales.pdf>
- Touhami, Z. O., Benlafkih, L., Jiddane, M., Cherrah, Y., El Malki, H. O., & Benomar, A. (2011). Neuromarketing: Where marketing and neuroscience meet. *African Journal of Business Management*, 5(5), 1528-1532. doi: 10.5897/AJBM10
- Vágnerová, J. (2017). *Vývojová psychologie: Dětství a dospívání*. Praha: Karolinum.
- Vysekalová Jitka et al. (2014). *Emoce v marketingu: Jak oslovit srdce zákazníka*. Prague: Grada.

## **Contact information**

**Mgr. Denisa Kraľovičová, PhD.**

University of Ss. Cyril and Methodius in Trnava, Faculty of Mass Media Communication

Nam. J. Herdu 2, 91701, Trnava, Slovak Republic

E-mail: denisa.kralovicova@ucm.sk

ORCID: 0000-0001-6149-3919

doi: 10.7441/dokbat.2019.057

# PUBLIC HOSPITAL PERFORMANCE MANAGEMENT: A QUESTIONNAIRE DESIGN

*Josef Krupička*

## **Abstract**

Growing concern about the efficiency and effectiveness of Czech public healthcare stirred up many discussions about the possible deterioration in the quality of care. While similar trends in the last century resulted in the introduction of New Public Management inspired reforms and the adoption of private sector management practices in the public sector, their utilization in public healthcare did not fully yield the desired outcomes in the area of performance management. While the literature provides an interesting insight into the issues related to performance management in health systems of various countries, thus providing a knowledge basis for comparison and finding of the most suitable mix of practices, the performance management in Czech public healthcare and its potentials has been to date only scarcely examined. This paper aims to develop the methodology for the examination of performance management aspects in this environment as this knowledge would benefit the policymakers and practitioners. Inspired by the mixed approach, this paper presents the design of a questionnaire and the follow-up interview, which would provide complementary evidence on the examined issue. The final version of the questionnaire was tested in the pilot phase with the initial results presenting valuable feedback aiding in the development of the final version of the survey and also providing the indicative results regarding the performance management practices.

*Keywords:* performance management, performance measurement, public hospital, research design, survey design, healthcare management

## **1 INTRODUCTION**

According to annual survey „Barometer of Czech Healthcare“ using Balanced-scorecard approach, there is a growing concern amongst the hospital directors regarding the possible deterioration of quality of care and while the most of them perceive the Czech healthcare system being of good quality, more than 70% of them acknowledge the need for the increase in effectiveness and efficiency of their hospital (HealthCare Institute Czech Republic, 2019). Nevertheless, it is the capability to measure the effectiveness and efficiency of hospital activities, which prerequisites the assessment of hospital performance and allows contemplating actions leading to a possible improvement in performance. Therefore, the existence of the performance measurement system represents an essential enabling factor for functional performance management in the hospital.

However, the performance measurement in the healthcare industry is, in comparison with performance measurement in other industries, rather complex issue due to the challenging nature of the healthcare environment. The complexity of healthcare service (Cylus, Papanicolas & Smith, 2016; Campanale, Cinquini & Tenucci, 2014), the ethics of professional subculture (Castlen et al., 2017; Martinussen & Magnussen, 2011), the constraints of regulatory framework (Mettler & Rohner, 2009), the public ownership form (Hvidman & Andersen, 2014), while all of these aspects highly influence the performance measurement in healthcare environment, the concept of the performance itself is a multidimensional aspect which can be defined on many levels (Mettler & Rohner, 2009; Veillard et al., 2005). In this regard, the

proper understanding of this environment and its inner cause-effect relations is crucial in the pursuit of achieving better performance.

While many aspects of performance measurement in healthcare environment have been thoroughly examined, the development of any unifying theory for hospital performance management is unlikely due to the existing variability in this environment (Eldenburg, Krishnan & Krishnan, 2017) and the differences between the healthcare settings of individual countries rather open the way for in-depth examination of this issue on the national level and sharing of obtained knowledge (Joumard, André & Nicq, 2010). Since the private hospitals represent only negligible share of healthcare providing system in the Czech Republic, to better understand the aspects of performance management in the case of Czech public hospitals is the primary motivation for this research, and the aim of this study to develop a comprehensible survey capturing the aspects of performance management in this environment and their relation to hospital output. To reach this aim, the first part of this paper deals with the theoretical background of performance measurement in healthcare and then presents the evidence from various countries as well as summarizes the practical background for the Czech healthcare. The next part goes through the survey design process resulting in the developed survey, which is followed by the discussion of expected results. The final part concludes the results obtained during the pilot testing and the next steps in the research.

## **2 METHODOLOGY**

### **2.1 Theoretical Background**

The concept of performance can be generally understood as an overall economic and operational proficiency aiming towards company success and excellence in its activities (Tangen, 2005). However, the understanding of this concept and its management varies in line with existing organizational differences between diverse subjects. Public institutions, such as hospitals, differ from their private profit-oriented counterparts in complexity and ambiguity of their goals (Hvidman & Andersen, 2014). In his review of papers examining the efficiency measurement in healthcare, Hollingsworth (2008) cautiously contemplates about the public provision of healthcare being potentially more efficient than private in general while he also underlines that public and private enterprises operate with respect to different objectives and technological frontiers and thus cannot be easily compared. For example, while in the case of private for-profit hospitals are the economic key performance indicators (e.g. return on equity) expected to play an important role, they would be less relevant in the case of public hospitals focusing on cost-efficient coverage of care for the patients in general and unlike private hospitals even providing unprofitable yet strategic services (e.g. treatment of high voltage burns).

Veillard et al. (2005) define six different dimensions of hospital performance (clinical effectiveness, efficiency, staff orientation, responsive governance, safety, patient centeredness) stretching the concept of performance beyond organizational proficiency. Mettler & Rohner (2009) offer a different definition of areas of hospital performance (healthcare financial strength, healthcare operations, healthcare people development, patient service and satisfaction, and healthcare marketing). Regardless of the specific definitions, the performance concept in the hospital environment is multidimensional, and thus the performance measurement focuses on the aspects of the economy and efficiency as well as the quality of care and its delivery.

While the early attempts of systematic performance assessment in the healthcare environment could be traced back into the eighteenth century, it was the second half of the twentieth century that defined the essentials of modern performance management in hospitals (McIntyre, Rogers

& Heier, 2001). Many studies regard (i.e. van Elten, van der Kolk & Sülz, 2019; Schwartz & Deber, 2016; Nyland & Pettersen, 2004) the New Public Management (NPM) approach defined during this era as the main inspiration for the implementation of policies and management techniques aiming to improve the performance of public healthcare. Although the NPM inspired reforms in healthcare varied across the different countries, the issues accompanying the introduction of performance management appear to be of the same nature, and their influence on actual performance is arguable as was in the case of other public institutions (i.e. Hvidman & Andersen, 2014).

Nyland & Petersen (2004) in their study of performance measurement concepts implemented in Norway hospital sector pointed out the crudeness of measurement insufficiently reflecting the complexity of provided services as being one of the main drivers for the reduction of informational value obtained from the performance measurement systems (PMS) which provided little guidance for performance management. Similar findings regarding the poor measurement were identified by Mannion & Braithwaite (2012) in the case of English NHS next to the factors of misplaced incentives, breach of trust, and politicization of performance system. The study of Speklé & Verbeeten (2014) presented the aspects of problematic measurement and the narrow focus on accountability, disregarding the other possible uses of PMS as being issues for performance management in the public sector in general. The common mediator of PMS success appears to be PMS usage (van Elten, van der Kolk & Sülz, 2019; Speklé & Verbeeten, 2014).

Examination of PMS employed in Dutch hospitals performed by van Elten, van der Kolk and Sülz (2019), resulted in the classification of PMS usage into three categories differently influencing hospital output. The operational use (e.g. for budget control) positively related to operational performance and negatively to patient-oriented care, the exploratory use (to learn and improve) positively influencing the quality of care and the incentive-oriented use with no relevance to hospital performance (van Elten, van der Kolk & Sülz, 2019). The results for exploratory use were in line with findings of Speklé & Verbeeten (2014), yet different in the case of incentive-oriented use, where Speklé & Verbeeten (2014) observed negative relation to performance arising from opportunistic behaviour. In their analysis of PMS adopted in health systems of various English speaking countries, Schwartz & Deber (2016) pointed out the operational use of measurement results being the leading cause of performance measurement-management divide leading to little use of performance information for the improvement in performance management. Zidarov et al. (2016) identified the causes of performance measurement-management divide being the inadequate planning about PMS potential use, the lack of senior management engagement and the insufficient amount of resources dedicated to PMS implementation. These factors resulted in the creation of sub-optimal PMS, serving as a monitoring tool instead of a decision-making supporting tool (Zidarov et al., 2016).

The factor of inadequately solved PMS design driving the sub-optimal performance management was also identified by Mettler & Rohner (2009) in their exploratory survey of Swiss hospitals. Furthermore, their work highlighted the factors of healthcare regulatory framework and market dynamics affecting the adoption of performance management (Mettler & Rohner, 2009) as these factors via changes in management potentially influence the quality, safety and efficiency (McConnell et al., 2014). Other studies also regard the sound informational infrastructure and its adequate support by information technologies (IT) as the enabling factor of effective performance management (Bardhan & Thouin, 2013; Angst et al., 2011). During his examination of Spanish public hospitals, Naranjo-Gil (2016) identified the professional background of the management involved in the adoption of performance management being an important factor influencing the quality of adopted performance influential policies. The clinical background of involved management facilitates the alignment



between PMS usage and strategic priorities, which in turn influences the hospital performance (de Harlez & Malagueño, 2016) and increases the cost-consciousness amongst the clinicians (Lehtonen, 2007).

The aspects affecting the quality of the performance management appear to be similar in the case of public hospitals regardless variety of healthcare settings in reviewed studies. The alignment of PMS design with its intended use, close cooperation with clinicians in the adoption of performance management practices and the other mentioned factors seem to mediate the impact of performance management of hospital output. Therefore, the examination of these factors in the Czech public hospitals should yield practical insight into the environment.

## **2.2 Practical background**

Czech healthcare is predominantly funded by public sources represented by statutory health insurance based on compulsory membership. The service covered by this system is universal in general, the actual scope of covered service is defined by the combination of regulating mechanism such as the legislation, listing the range of covered procedures and the arrangements between health insurance funds and healthcare providers defining the conditions of reimbursement and the volume of service (Alexa et al., 2015). The healthcare is provided by various subjects ranging from local physicians to large teaching hospitals, though the segment of public hospitals accounts for more than half of public expenditures (IHIS CR, 2018) and dominantly determines the performance of the healthcare system. While there also exists the segment of private hospitals, its performance in general does not appear to differ from the performance of public hospitals (Papadaki & Staňková, 2016) and since the performance management practices applied in these institutions are expected to be for-profit oriented and thus different in their aims from practices applied in public hospitals, the private hospital segment remains out of scope of this research.

Although the healthcare expenditures in Czech Republic of 7.1% of GDP in 2017 were well below the EU28 average of 9.6% (OECD/EU, 2018), the pressure on public budgets grows and the increasing need for financial reform remains unaddressed due to lack of political consensus (Alexa et al., 2015). Besides the growing economic pressures, Czech healthcare is struggling with the lack of medical personnel and management effectiveness, which might, according to hospital directors, even result in the possible deterioration in the quality of care (HealthCare Institute Czech Republic, 2019). Under such conditions, the obtaining of relevant information about performance is crucial as it provides the essential basis for optimization of hospital activities, thus partially relieving the pressure on existing personnel, and reliable evidence necessary for enforcing any performance-influential policies on the system level.

## **2.3 Survey design**

The survey aims to provide a comprehensible picture of performance management practice in Czech public hospitals, which essentially means to provide measurable evidence on the aspects of performance management identified during the literature review and to the comprehensible explanation of the identified state. The complexity of examined aspects induces the employment of a mixed approach, which allows to adequately address the multi-faceted issue in the context of the healthcare environment (Doyle, Brady & Byrne, 2009). While this approach has its limitations (i.e. Morgan, 2007), the methodological triangulation should enhance the informational value obtained by quantitative research tools (Doyle, Brady & Byrne, 2009). The research is segmented into three stages to mitigate the possible limitations of a mixed approach. The preliminary stage dealing with the issues of methodological design of adopted research tools, of the literature review, examining the findings and design of similar studies, and the preliminary testing and consultations of selected research tools with potential

respondents. The on-site stage consists of the data collection via questionnaire and the face-to-face interview for each respondent. The final research stage concludes the analysis of obtained results and their structured presentation.

In line with its descriptive purpose and aim to provide the basis for further learning, the cross-sectional survey design was adopted conventionally for the research in management accounting (van der Stede, Young & Chen, 2005). The segment of public hospitals represented the target population, as these institutions represent the core of the healthcare provisioning body. Based on the previous research experience with population-wise questionnaire providing surface-level knowledge about the extent of performance management (Krupička, 2018), only several public hospitals were selected as the narrow research sample should allow to better focus on the context of the examined subjects and thus obtain more in-depth insight into performance management though the indicative value of results regarding their validity for the whole population is acknowledged as well as the limitations of this approach (van der Stede, Young & Chen, 2005). The selection of the narrow research sample was based on their proximity to the author's university and the willingness of hospital management to participate in further research indicated in the previous survey. The respondent group concludes the managers from both the clinical environment and hospital administration in order to capture the performance management on both the hospital and clinical level as well as their subjective regard of the performance management practice.

The survey consists of a written questionnaire and a personal interview. The structured questionnaire employs the 7-point Likert scale ranging from strongly agree (7) to strongly disagree (1) on which are the respondents asked to what extent they agree with the presented statement. The use of this scale was motivated by the subjective nature of examined phenomena as well as by the common research practice for the examined environment (i.e. van Elten, van der Kolk & Sülz, 2019; de Harlez & Malagueño, 2016; Naranjo-Gil, 2016). The content of the questionnaire is structured into two parts. The introductory part defines the examined concepts, such as performance and the performance management in order to anchor the respondents' perception of these concepts, and then investigates the background of the respondent (i.e. their professional background, work experience in the organization). The second part consists of one-open ended question asking the respondent to present any measures which they perceive to reflect the performance and the twenty-two individual statements focusing on individual aspects of performance management (Table 1). The motivation for the open-ended question is to explore whether there is a difference in perception of performance between the respondents. Two Likert scales are presented for each of the examined statements, and respondents are asked to express their level of agreement with the statement on the first scale and to what extent they perceive the presented aspect to influence the hospital performance on the other scale.

Tab. 1 – The title of the table. Source: own research

Aspects	Sources
The scope of the measurement and its capability to reflect clinical and hospital performance	Speklé & Verbeeten, 2014; Mannion & Braithwaite, 2012; Nyland & Pettersen, 2004
The reliability of performance information and its informational value for the decision-making activity	Nyland & Pettersen, 2004
Connection of measures to hospital performance and strategy	Mettler & Rohner, 2009
The quality of data collection and evaluation processes	McConnell et al., 2014; Mettler & Rohner, 2009
The support of performance measurement processes by information technologies	Bardhan & Thouin, 2013; Angst et al., 2011; Mettler & Rohner, 2009
The usage of performance information and the orientation of the performance measurement system	van Elten, van der Kolk & Sülz, 2019; Schwartz & Deber, 2016; Speklé & Verbeeten, 2014
The communication of performance information to the personnel	Jääskeläinen & Roitto, 2015; Wettstein & Kueng, 2002

The engagement of clinical managers in performance management	de Harlez & Malagueño, 2016; Zidarov et al., 2016
The influence of regulatory framework and market dynamics on performance management	McConnell et al., 2014; Mettler & Rohner, 2009

The personal on-site visit was selected as the approach for data collection, since it allows to achieve the higher response rate albeit at the cost of time (Kelley et al., 2003) and enabled the use of post-questionnaire interview which allows to carefully approach the potentially sensitive issue (Kallio et al., 2016). The research team for the on-site visit consists of the interviewer and the interview observer to validate the information obtained during interviews and limit the possible subjective bias of the interviewer (Kallio et al., 2016). Before the on-site visit, the research team contacts the hospital administration regarding their research intention in order to obtain the support of the management for the realization of the survey. Following this step, the individual on-site visits are conducted, and the questionnaire is presented to the individual respondents. Within an hour or less long session is an individual respondent asked to fill the questionnaire in and interviewed by the research team. During the questionnaire, the respondents are assisted by the research team for clarification of statements if necessary. The questionnaire is presented in Czech, and the follow-up interview is conducted in Czech as well to ensure the respondents fully understood the questions.

Since the main aim of the post-questionnaire interview is to examine the motivation behind the answers obtained by the questionnaire and enhance the additional context, the interview is semi-structured and follows the thematic structure of the questionnaire. The results obtained from the questionnaire will be analysed using methods of statistical analysis (mainly descriptive statistics, correlation analysis, and statistical regression), and the content analysis will be deployed for the interpretation of the interviews. As the inquiring nature of the survey implies, the hypotheses for the quantitative part of the research are defined separately for each of the examined variables as the examined variable being the most influential driver of hospital performance since the results should allow comparing the influence of each aspect of performance management on the hospital performance with the level of influence measured by the strength of its correlation coefficients and values of descriptive statistics. The findings will be summarized into a comprehensible summary for practitioners and presented at the scientific conference. While the research design stage is currently almost at its end finishing the pilot testing phase, the beginning of the data collection process is planned from December 2019 to February 2020 and would target the maximum of respondents for each examined institution with at least 30 realized surveys per hospital to obtain sufficiently sound data basis.

#### **2.4 The pilot testing and the expected results**

To properly respect all the necessary steps in the survey design (Kelley et al., 2003), the pilot testing of the survey begun during September 2019. To date, the results have brought some beneficial feedback for survey design as well as the indication of expected results. Five complete reviews were realized in total, with additional feedback obtained from academics with experience in the field of survey research. The on-site personal approach to the respondents has proven to be the right way since the respondents were willing to give more time to the interaction with the research team and were more open during the interviews than was in the case of phone calls during the initial contact. Although both the questionnaire and interviews were realized during the pilot as was planned without any significant setbacks or discomfort situations, three statements have proven to be somewhat ambiguous and required their explanation by the research team. This experience resulted in the splitting of one unclear statement into two and the slight modification of the remaining two ambiguous statements. During the interview, the respondents were open, and although they mostly acknowledged the necessity of performance management, they inclined towards scepticism about its impact on

actual performance due to the unreliability of currently employed performance measurement systems.

Although there was to date a negligible number of respondents, their responses indicated some similarities to the results observed by other studies from which the most notable are hereby noted. The aggregated measurement appears to be inadequate to the complexity of service, as was in the case of studies performed by Nyland & Pettersen (2004) and Mannion & Braithwaite (2012) and the cause of this state appears to be the inadequate understanding of transformational process during the PMS implementation phase. The connection between the measurement and the organizational strategy does not appear to be properly established, as was in the case of Mettler & Rohner (2009), which is possibly due to the rather operational use of PMS. The primary purpose of the performance management appears to be operational as well, and the focus on the budget control is not surprising since the public hospitals are subjected to the rules of budgetary responsibility (Act No. 23/2017, Coll.) and their ability to control costs is higher than the control over the distribution of care and reimbursement. While these results are only indicative, they offer some interesting points to focus on during further interviews.

### **3 CONCLUSION**

The contextual background of Czech healthcare offers some interesting yet challenging issues of which closer examination would be beneficial for the academic community as well as practitioners aspiring to tackle the growing issue of inefficiency in public hospitals. Therefore, this research aims to contribute to this effort by providing measurable evidence on performance management practices in public hospitals, aspire to offer the interpretation of causes of the current state and promote the knowledge obtained from the studies examining the health system in other countries in order to contribute to the effort of finding the most suitable mix of practices leading to possible improvement in performance of Czech public hospitals. This particular paper dealt with the design of the survey aiming to provide yet additional shard to the fragmented mosaic of studies examining the performance management in the environment of Czech healthcare.

Based on the results from the literature review and the design of similar studies, the survey employs a mixed research approach utilizing both the questionnaire and the interview as this approach appears to be the most appropriate for the research aim. Although both data collection tools have their limitations, their complementary use should mitigate their deficiencies, and thus the remaining limitation lies within the process of survey sample selection. While the bias stemming from the selection of hospitals limits the possible generalization of the results on the population level, it should still allow drawing conclusions beneficial for other practitioners as no such research has been to date realized according to the available knowledge.

With the pilot testing nearing to its end, the results have brought useful information about the existing deficiencies in the questionnaire design, which will be addressed after the end of the pilot phase. Since there is still a potential of improvement in the survey design, the further discussion of its design is invited as well as any suggestions or commentaries, because only the thoroughly designed research is capable to adequately grasp the examined issue and provide the necessary insight into the topic of performance management in the healthcare environment.

## Appendix: Illustrative Version of Questionnaire Tested During Pilot Phase

<p><i>Open-ended question</i> : Which measures do you consider reflecting the hospital performance? Please present at least 3 examples.</p> <p><i>Statements</i> : Please use the scores of evaluation scale to express to what extent do you agree with the presented statement for your institution and to what extent do you perceive the presented aspect to influence overall performance of your institution</p> <p>1 = strong disagree, 2 = disagree, 3 = rather disagree, 4 = ambivalence, 5 = rather agree, 6 = agree, 7 = strong agree</p> <p>0) Example statement influencing the questionnaire result (<i>and its evaluation in the columns on the right</i>)</p> <p>1) The financial performance measures reflect the hospital performance</p> <p>2) The non-financial performance measures reflect the hospital performance</p> <p>3) The financial performance measures reflect the clinical performance</p> <p>4) The non-financial performance measures reflect the clinical performance</p> <p>5) The performance measurement system provides the reliable information about performance</p> <p>6) The scope of performance measurement system support decision-making</p> <p>7) The relation of financial performance measures to operational performance is comprehensibly defined</p> <p>8) The relation of non-financial performance measures to operational performance is comprehensibly defined</p> <p>9) The relation of financial performance measures to organizational strategy is comprehensibly defined</p> <p>10) The relation of non-financial performance measures to organizational strategy is comprehensibly defined</p> <p>11) The performance data collection process is automated (no manual data collection is required)</p> <p>12) The performance data evaluation process is automated (e.g. automated standardized reports, on-demand visualization)</p> <p>13) The performance measurement system is adequately supported by information technologies in data collection process</p> <p>14) The performance measurement system is adequately supported by information technologies in data evaluation process</p> <p>15) The performance information is used for budget control and operational planning (operational use)</p> <p>16) The performance information is used for rewarding employees (incentive-oriented use)</p> <p>17) The performance information is discussed with organizational members to identify their cause (exploratory use)</p> <p>18) The performance information is communicated to the personnel</p> <p>19) The performance management is influenced by regulatory framework (e.g. Reimbursement Decree)</p> <p>20) The performance management is influenced by market dynamics (e.g. competition)</p> <p>21) The clinician managers are involved in performance management</p> <p>22) The non-clinical managers are involved in performance management</p>
--

## References

- Alexa, J., Rečka, L., Votápková, J., van Ginneken, E., Spranger, A., & Wittenbecher, F. (2015). Czech Republic: Health system review. *Health Systems in Transition*, 17(1), 1-165. Retrieved from [http://www.euro.who.int/\\_\\_data/assets/pdf\\_file/0005/280706/Czech-HiT.pdf](http://www.euro.who.int/__data/assets/pdf_file/0005/280706/Czech-HiT.pdf)
- Angst, C. M., Devaraj, S., Queenan, C. C., & Greenwood, B. (2011). Performance Effects Related to the Sequence of Integration of Healthcare Technologies. *Production and Operations Management*, 20(3), 319-333. doi: 10.1111/j.1937-5956.2011.01218.x
- Bardhan, I. R., & Thouin, M. F. (2013). Health information technology and its impact on the quality and cost of healthcare delivery. *Decision Support Systems*, 55(2), 438-449. doi: 10.1016/j.dss.2012.10.003
- Campanale, C., Cinquini, L., & Tenucci, A. (2014). Time-driven activity-based costing to improve transparency and decision making in healthcare: A case study. *Qualitative Research in Accounting & Management*, 11, 165-186. doi: 10.1108/QRAM-04-2014-0036
- Castlen, J. P., Cote, D. J., Moojen, W. A., Robe, P. A., Balak, N., Brennum, J., Ammirati, M., Mathiesen, T., & Broekman, M. L. D. (2017). The Changing Health Care Landscape and Implications of Organizational Ethics on Modern Medical Practice. *World Neurosurgery*, 102, 420-424. doi: 10.1016/j.wneu.2017.03.073

- Cylus, J., Papanicolas, I., & Smith, P. (2016). *Health system efficiency: how to make measurement matter for policy and management*. Copenhagen, Denmark: World Health Organization. Retrieved from [www.ncbi.nlm.nih.gov/books/NBK436888/pdf/Bookshelf\\_NBK436888.pdf](http://www.ncbi.nlm.nih.gov/books/NBK436888/pdf/Bookshelf_NBK436888.pdf)
- de Harlez, Y., & Malagueño, R. (2016). Examining the joint effects of strategic priorities, use of management control systems, and personal background on hospital performance. *Management Accounting Research*, 30, 2-17. doi: 10.1016/j.mar.2015.07.001
- Doyle, L., Brady, A. M., & Byrne, G. (2009). An overview of mixed methods research. *Journal of Research in Nursing*, 14(2), 175-185. doi: 10.1177/1744987108093962
- Eldenburger, L. G., Krishnan, H. A., & Krishnan, R. (2017). Management Accounting and Control in the Hospital Industry: A Review. *Journal of Governmental & Nonprofit Accounting*, 6(1), 52-91. doi: 10.2308/ogna-51922
- HealthCare Institute Czech Republic (2019). *Barometer of Czech healthcare: Press release*. Prague: HealthCare Institute Czech Republic. Retrieved from [http://www.hc-institute.org/userfiles/files/Barometr%20českého%20zdravotnictví%202019%20-%20tisková%20zpráva\(1\).pdf](http://www.hc-institute.org/userfiles/files/Barometr%20českého%20zdravotnictví%202019%20-%20tisková%20zpráva(1).pdf)
- Hollingsworth, B. (2008). The measurement of efficiency and productivity of health care delivery. *Health Economics*, 17(10), 1107-1128. doi: 10.1002/hec.1391
- Hvidman, U., & Andersen, S. C. (2014). Impact of performance management in public and private organizations. *Journal of Public Administration Research and Theory*, 24(1), 35-58. doi: 10.1093/jopart/mut019
- IHIS CR (2018). *Economic results of hospitals 2017*. Retrieved from <https://www.uzis.cz/system/files/eknem2017.pdf>
- Jääskeläinen, A., & Roitto, J. M. (2015). Designing a model for profiling organizational performance management. *International Journal of Productivity and Performance Management*, 64(1), 5-27. doi: 10.1108/ijppm-01-2014-0001
- Jourard, I., André, C., & Nicq, C. (2010). Health Care Systems: Efficiency and Institutions. *OECD Economics Department Working Paper No. 769*. doi: 10.2139/ssrn.1616546
- Kallio, H., Pietilä, A. M., Johnson, M., & Kangasniemi, M. (2016). Systematic methodological review: developing a framework for a qualitative semi-structured interview guide. *Journal of Advanced Nursing*, 72(12), 2954-2965. doi: 10.1111/jan.13031
- Kelley, K., Clark, B., Brown, V., & Sitzia, J. (2003). Good practice in the conduct and reporting of survey research. *International Journal for Quality in Health Care*, 15(3), 261-266. doi: 10.1093/intqhc/mzg031
- Krupička, J. (2018). *The relevance of management accounting tools in the public hospital management in the Czech Republic*. Paper presented at the 32nd International Business Information Management Association Conference, Seville, Spain. Retrieved from <https://ibima.org/accepted-paper/relevance-of-management-accounting-tools-in-public-hospital-management-in-czech-republic/>
- Lehtonen, T. (2007). DRG-based prospective pricing and case-mix accounting: Exploring the mechanisms of successful implementation. *Management Accounting Research*, 18(3), 367-395. doi: 10.1016/j.mar.2006.12.002

- Mannion, R., & Braithwaite, J. (2012). Unintended consequences of performance measurement in healthcare: 20 salutary lessons from the English National Health Service. *Internal Medicine Journal*, 42(5), 569-574. doi: 10.1111/j.1445-5994.2012.02766.x
- Martinussen, P. E., & Magnussen, J. (2011). Resisting market-inspired reform in healthcare: The role of professional subcultures in medicine. *Social Science & Medicine*, 73, 193-200. doi: 10.1016/j.socscimed.2011.04.025
- McConnell, K. J., Chang, A. M., Maddox, T. M., Wholey, D. R., & Lindrooth, R. C. (2014). An exploration of management practices in hospitals. *Healthcare*, 2(2), 121-129. doi: 10.1016/j.hjdsi.2013.12.014
- McIntyre, D., Rogers, L., & Heier, E. J. (2001). Overview, history, and objectives of performance measurement. *Health Care Financing Review*, 22(3), 7-21. Retrieved from <https://search.proquest.com/docview/1826614879?accountid=15518>
- Mettler, T., & Rohner, P. (2009). *Performance Management in Health Care: The Past, the Present, and the Future*. Paper presented at 9. Internationale Tagung Wirtschaftsinformatik (WI 2009), Wien. Wien: Österreichische Computer Gesellschaft. Retrieved from <https://www.alexandria.unisg.ch/214579/>
- Morgan, D. L. (2007). Paradigms Lost and Pragmatism Regained. *Journal of Mixed Methods Research*, 1(1), 48-76. doi: 10.1177/2345678906292462
- Naranjo-Gil, D. (2016). The Role of Management Control Systems and Top Teams in Implementing Environmental Sustainability Policies. *Sustainability*, 8(4), 359. doi: 10.3390/su8040359
- Nyland, K., & Pettersen, I. J. (2004). Performance management and measurement concepts for better management control in public hospitals? A study of the hospital sector in Norway. *Health Organization Research Norway Working paper 2004:5*. Retrieved from <https://www.duo.uio.no/handle/10852/30307>
- OECD/EU (2018). *Health at a Glance: Europe 2018: State of Health in the EU Cycle*. Paris: OECD Publishing. doi: 10.1787/health\_glance\_eur-2018-en
- Papadaki, Š., & Staňková, P. (2016). Comparison of horizontally integrated hospitals in private and public sectors of Czech Republic. *Economics and Sociology*. doi: 10.14254/2071-789X.2016/9-3/16
- Schwartz, R., & Deber, R. (2016). The performance measurement–management divide in public health. *Health Policy*, 120(3), 273-280. doi: 10.1016/j.healthpol.2016.02.003
- Speklé, R. F., & Verbeeten, F. H. M. (2014). The use of performance measurement systems in the public sector: Effects on performance. *Management Accounting Research*, 25(2), 131-146. doi: 10.1016/j.mar.2013.07.004
- Tangen, S. (2005). Demystifying productivity and performance. *International Journal of Productivity and Performance Management*, 54(1), 34-46. doi: 10.1108/17410400510571437
- van der Stede, W. A., Young, S. M., & Chen, C. X. (2005). Assessing the quality of evidence in empirical management accounting research: The case of survey studies. *Accounting, Organizations and Society*, 30(7-8), 655-684. doi: 10.1016/j.aos.2005.01.003
- van Elten, H. J., van der Kolk, B., & Sülz, S. (2019). Do different uses of performance measurement systems in hospitals yield different outcomes? *Health Care Management Review*, 1. doi: 10.1097/hmr.0000000000000261

- Veillard, J., Champagne, F., Klazinga, N., Kazandjian, V., Arah, O. A., & Guisset, A. L. (2005). A performance assessment framework for hospitals: The WHO regional office for Europe PATH project. *International Journal for Quality in Health Care*, 17(6), 487-496. doi: 10.1093/intqhc/mzi072
- Wettstein, T., & Kueng, P. (2002). A maturity model for performance measurement systems. *Management Information Systems*, 26, 113-122. Retrieved from <https://pdfs.semanticscholar.org/1cc1/5619b86ad2a1fd10481e29b45b28c6eeafd7.pdf>
- Zidarov, D., Sicotte, C., Menon, A., Hallé, M. C., & Poissant, L. (2016). Factors influencing use of a performance measurement system in a rehabilitation hospital. *Journal of Hospital Administration*, 5(5), 79-90. doi: 10.5430/jha.v5n5p79

### **Contact information**

#### **Ing. Josef Krupička**

University of Economics, Prague, Faculty of Finance and Accounting  
Winston Churchill Sq. 1938/4, 13067, Prague, Czech Republic  
E-mail: josef.krupicka@vse.cz  
ORCID: 0000-0003-4092-2491

doi: 10.7441/dokbat.2019.058



# REASONS AND PROPOSAL OF APPLICATION OF MANAGEMENT METHODS IN PROCESSES OF QUALITY ASSURANCE AT HIGHER EDUCATION INSTITUTIONS IN THE SLOVAK REPUBLIC

*Adriana Krupová*

## **Abstract**

An ongoing discussion on "what is the quality of higher education institutions in its essence" and "what are the possibilities of ensuring it" raise the question of how to apply quality management system within the scope of newly approved legal norms in Slovak Republic, particularly Act no. 269/2018 Coll. on Quality Assurance in Higher Education. While previous conceptual changes of higher education were mainly focused on the economic area, the new legislation extends the competences of higher education institutions in fields of management and governance and establishes the principle of primary responsibility of the university for quality. Following the definition of quality in higher education and building on the basis of systematic study of the implementation of the Bologna Declaration elements (European Commission, n.d.), this contribution provides an insight into the essence of quality assurance in higher education. At the same time, it pays attention to the fact that, when implementing a quality management system, it is necessary to focus the activities of higher education management consciously on two equal areas, namely content and process. The paper deals the current state and the possibilities of application of quality management systems in the environment of higher education institutions resulting from the basic principles of existing models of quality management. The aim of the article is to contribute to the current national debate by presenting actual status of management methods application in the terms of higher education institutions quality management processes in Slovak Republic, emphasizing the quality of education as one of the three functions of a higher education institution, pointing out the need to manage the quality of all university functions, and in particular by informing about the need to implement an internal quality assurance and verification system in terms of two equivalent aspects - content and procedural. The current transformation of higher education institutions in the Slovak Republic needs to be reflected in management approach change of these non-business sector organizations. In this sense, we can talk about management or organizational innovations.

**Keywords:** *quality, management methods, higher education, self – assessment, quality assurance, Slovak Republic*

## **1 INTRODUCTION**

The motive of this paper concerning an implementation of management methods in public organizations - higher education institutions in Slovak Republic was the fact that within the process of ongoing reform of higher education (HE) in the sense of Bologna objectives many uncertainties arose by insufficient law and implementing rules in this field, unclear relations between indicators and, last but not least, lack of previous experience. Unlike most of other European countries, higher education institutions were part of state planning and regulation during the totalitarian regime. Due to their economic and financial security, they were to a minimum extent forced to seek ways to increase the efficiency of their activities (Galáš, 2017). Even after signing the Bologna Declaration in 1999, universities in Slovak Republic did not perceive need for change as a matter of urgency as there was high interest of applicants in that

time. Gradually introduced changes in the higher education environment were related, for example, to the introduction of three level in HE, the introduction of a credit system, the strengthening of legislative mechanisms to conduct business activities, etc. It follows that the strengthening of autonomy has focused mainly on the economic and financial field, but less on the management and governance.

A major turning point has been so far the amendment to the Higher Education Act No. 131/2002 Coll. adopted in 2013 (2019), which requires universities to have a built-in 'internal quality system'. This system should in principle be identical to the "Standards and Guidelines for Quality Assurance in the European Higher Education Area" (ESG, 2015), which were developed by higher education professionals and are influenced by systemic approaches to quality management, in particular ISO and TQM.

It can be stated that since 2013, a space has been created for higher education institutions to develop a quality management system that fully meets their objectives and needs. The newly approved amendment to the Higher Education Act (Act no. 131/2002 Coll. on Higher Education, 2019) and the new law on quality assurance in higher education (Act no. 269/2018 Coll. on quality assurance of higher education, 2018) continue from the national level to set the trend and create even greater scope for strengthening the autonomy and primary responsibility of higher education institutions for effective quality management of higher education provided.

This situation represents a major challenge for management, as the reform initiated is still incomplete and the Slovak higher education institutions expect to support the change of governance approach in particular by a clear procedural structure resulting from legal standards and other quality management support mechanisms. Systematic approaches to management in the environment of higher education institutions have untapped potential, as confirmed by the Slovak Rector's Conference in its periodical.

Based on the theoretical background, the author of this paper can state that the principles that apply in the business environment can be well implemented in the environment of non-business organizations. Given the facts from professional resources, the author's practical experience in the organization and management of higher education institutions, as well as from the implementation of quality management model in higher education institution, it can be concluded that now more than ever is necessary to find solutions in this field and bring new information, ideas and good practice concepts. At the same time, self-assessment is considered in this paper as one of the most effective methods of measuring and evaluating data on the performance and effectiveness of processes and thus the whole organization.

In the future, a current reform of higher education in Slovak republic will require the assessment, selection and application of management methods that are suitable for higher education. This paper brings a theoretical study supplemented by the results of the own research and the proposal of the realization on the basis of the own study.

## **2 METHODS**

In the research, the secondary information was obtained by study and analysis of published sources as well as from Internet sources. A combination of qualitative and quantitative research was used as the primary information source. The research was conducted in business and non-business subjects focused on the impact of the implementation of the management method - self-evaluation. The sample was selected by nonrandom selection – “Judgement Sampling”. The results of this preliminary research are reflected in the author's statements and views. The quantitative research was carried in the project of The Ministry of Education, Science, Research and Sport of Slovak Republic in cooperation with SAAIC, the national agency for the

programme Erasmus+ for Education and Training, entitled “Support for Implementation of Reform Tools in Slovak Higher Education” (SIHE, 2016). The research was carried out by means of a questionnaire. All universities in Slovak republic were addressed of which 22 universities participated.

### **3 REASONS OF THE NEED FOR APPLICATION OF MANAGEMENT METHODS**

Concept of quality in higher education is discussed quite often and creators of higher education system reforms systematically deal with it. What is behind such an interest on the quality of higher education institutions in the last two decades? The answer can be found in the Initiative of EU Signatory States named Bologna Declaration aimed to creation of European Higher Education Area approved in 1999 and in the documents of EU institutions derived from it regulating education and organizations implementing these policies, to name a few: European University Association (EUA, n.d.), European Association of Institutions in Higher Education (EURASHE, n.d.), European Association for Quality Assurance in Higher Education (ENQA, 2013), European Quality Assurance Register for Higher Education (EQAR, n.d.), European Students' Union (ESU, n.d.) and others.

In addition to the Declaration main aims including the system of easily readable and comparable academic titles, the two level system (pre-gradual and gradual), system of gaining and transfer of credits, increasing the mobility of students, teachers and researchers and improving European dimension of the education, two important aims of the declaration have risen as well – to ensure quality standards in higher education offer of the whole Europe and to improve the European coordination in the assessment of the quality of higher education.

Starting from the classical definition of the term 'quality', in the course of a systematic study of the content of the Bologna Declaration, as well as publications and studies of institutions supporting the implementation of the elements of this Declaration, I tend to believe that the answer to the abovementioned question can be found in the search for a basic balance of the main activities of higher education institutions. Assessing the quality of higher education institutions with a clear preference for assessing publishing and scientific performance requires balancing the three key functions of higher education institutions - educational, scientific, research and artistic, as well as related activities (support activities and the social role of higher education institutions, so called “third mission”). It is necessary to focus primarily on the historically primary function of the university - educational, which is currently underestimated.

### **4 EU ESENTIAL FRAMEWORK DOCUMENTS**

Standards and Guidelines for Quality Assurance in the European Higher Education Area (ESG, 2015) issued in 2005 by the European Association for Quality Assurance in Higher Education (ENQA, 2013) are a key document for achieving the objectives of the Bologna Declaration, which also reflects a change in the approach of higher education governance. The ESGs were reviewed by the EU ministers responsible for education in 2015. The ESGs (2015) consist of three parts: (1) European standards and guidelines for internal quality assurance of higher education; (2) European standards and guidelines for external quality assurance of higher education; and (3) European standards and guidelines for quality assurance agencies of higher education.

#### **4.1 Purposes and principles of ESG 2015**

The ESGs are a major factor in changing the approach to higher education management for several reasons. The ESGs include the field of higher education administration, i.e. the ways in which processes are managed, resources allocated, powers and responsibilities assigned, but in particular how strategic objectives are elaborated and the key stakeholders' requirements are met. Traditional and established quality management systems have provoked and evoked negative, rather than positive, responses in higher education environments, in particular with social and humanitarian focus. There is a relatively higher interest in the ESG, stemming mainly from the legislative requirements imposed on higher education institutions by the higher education institution. The reason for their greater acceptance is the fact that, in contrast to traditional management models, which were created by business experts, the ESGs were created directly by experts from higher education. The best experience of Europe's leading universities has been reflected in the individual requirements of the ESGs.

The ESGs have the following purposes: (a) set a common framework for quality assurance systems for learning and teaching at European, national and institutional level; (b) enable the assurance and improvement of quality of higher education in the European higher education area; (c) provide transparent information on quality assurance in the EHEA; and (d) support mutual trust, thus facilitating recognition and mobility.

The ESGs provide a framework with a semi-structured concept and are based on the principles of Total Quality Management (TQM), as their basic principles are: (a) the primary responsibility lies with higher education institutions for the quality and quality assurance of their provision; (b) quality assurance responds to the diversity of higher education systems, individual higher education institutions, their degree programs and students; (c) quality assurance supports the development of a quality culture; and (d) quality assurance considers the needs and expectations of students, other stakeholders and society.

Of particular importance is the fact that the ESGs framework provides for the implementation of self-assessment, in the implementation process section 2.3 specifically: "Implementing external quality assurance processes should be reliable, useful, pre-defined, implemented consistently and publicly available. These processes include - a self-assessment or equivalent; - an external assessment normally including a site visit; - a report resulting from the external assessment; - a consistent follow-up".

Based on this background, it is obvious that management methods and analytical techniques based on the TQM principles of quality management have been introduced for a long time to the higher education environment in the European area. From the author's point of view this impose an obligation for higher institution to apply management methods of governance.

#### **4.2 Management methods to evaluate the performance of an organization**

Each organization should fulfil its social mission efficiently and effectively, while efficiently means that it should fulfil all its social obligations; and effectively capitalize at the same time (each organization must have entrepreneurial behaviour). (Jakubeková, Paulová & Zgodavová, 2014)

The assessment of the efficiency of the (business) behaviour of an organization is based on an assessment of the extent to which it has been able to meet its strategic objectives meeting its social responsibility commitments at the same time while respecting generally accepted principles of business ethics. The assessment of the effectivity of organization's business behaviour is based on an assessment of the level of its business performance, a ratio indicator,

that compares the amount of operating income and total assets that have been used to achieve this value. (Jakubeková, Paulová & Zgodavová, 2014)

The difference between efficiency and effectiveness was perfectly defined by P. F. Drucker in his quote: "Efficiency is doing things right, effectiveness is doing the right things."

In performance measurement, managers should not focus solely on the assessment of financial indicators, since such a focus would most likely not ensure the long-term prosperity of the organization. The organization is an open business system and the results of its social impact should be assessed systemically. Not only according to a single, though significant indicator, but comprehensively according to several complementary and dimensionally compatible indicators. This applies to both business and non-business organizations, while in the case of universities, the area of social action is naturally dominant, but it can ensure a sustainable situation in the area of economic and governance of these institutions.

A proven and recommended approach to measuring organizational success is monitoring of Key Performance Indicators (KPIs). The organization must first define its strategic and operational objectives and then choose key indicators which best reflect its ability to achieve those objectives.

Currently, there are several management tools (concepts and models) to be used in both business and non-business entities to ensure such assessment, i.e. systemic performance measurement of different indicators. Katic, Majstorovic and Colak (2011) define two groups of models that they also consider most used: (1) models emphasizing self-evaluation - e.g. EFQM Excellence Model. These help the organization to identify those areas in which it can continue to improve (so-called self-assessment within the organization), but also allows comparison with competitors; and (2) models designed to support the management and improvement of business processes, such as the Performance Pyramid or Balanced Scorecard (BSC) (Mohelská & Pitra, 2012).

The development of non-financial indicators and the connection with the corporate strategy are considered to be the main function of these models. Critical assessment of business performance models was provided also by Vouldis and Kokkinaki (2011) who have defined the following business performance measurement tools by analysing the mentioned models: BSC; EFQM; ISO 9001; Performance Prism; Six Sigma; Tableau de Board. The Common Assessment Framework (CAF) model can also be associated with models underlining a self-assessment. In general, these are Total Quality Management (TQM) models that aim to find ways to increase organizational efficiency. Benchmarking can also be appended to the systemic performance measurement tools. A survey conducted by the Global Benchmarking Network (Searles, Mann & Kohl, 2013), showed that 39% of respondents used benchmarking for performance comparing; and a forecast for the future was stated that the use of benchmarking will continue in the private sector and its use in the public sector and non-profit organizations will be expanded.

These tools for measuring organizational performance are regularly included in one of the largest foreign studies focused on selected tools supporting decision-making of firm managements "Management Tool and Trends". Since 1993, the study has been carried out annually by Bain & Company. Compared to the most comprehensive research conducted annually by the aforementioned company, or to the research that is presented in the section on the state of use of management methods in Slovak Republic, management tools Balanced Scorecard and Benchmarking represent the penetration of individual researches focused on business performance evaluation. According to the data provided in Figure 1, it can be concluded that Benchmarking, Balanced Scorecard (BSC) and TQM models underlining self-

assessment are among the most widely used tools for assessing the organizational performance in the last two decades.



Fig. 1 – Top 10 Management tools. Source: Rigby & Bilodeau (2018)

## 5 LAW REGULATION – SLOVAK REPUBLIC

The signing of Bologna declaration, the ESGs, the conclusions of programming documents, e.g. reports of the European Commission Group for the Modernization of Higher Education and the outcomes of projects with many recommendations for further action have become the basis for changes in higher education legislation in Slovak Republic. However, in the first phase of the reform, these changes were mostly of economic nature and only partially included quality assurance. The results of the Comprehensive Accreditation, which took place in 2014–2016, contained rather a formal evaluation of higher education quality assurance at universities.

By the newly adopted legislation in 2018, the comprehensive accreditation of higher education activities, which included evaluation of education as well as research and creative activity, ceased to exist. A new accreditation agency will evaluate how the university adheres to prescribed standards for higher education and higher education quality management.

### 5.1 Legislation in Slovak Republic

A breakthrough in the assurance of quality in Higher Education in Slovak Republic should be brought by the application of Act No. 269/2018 Coll. on Quality Assurance in Higher Education and Act No. 270/2018 Coll., amending the Higher Education Act No. 131/2002 Coll.

These new legal standards extend the competences of higher education institutions in the fields of management and governance and establish the European principle of the primary responsibility of higher education institutions for their quality. At the same time, they impose on universities the task to apply a comprehensive quality management system, the functionality of which will play an important role in the field of accreditation, evaluation, whether at national or international level; and in support of scientific research activities as well.

New legislation, the Act on Quality Assurance in Higher Education, approved by the National Council of Slovak Republic on 19 June 2018, regulates the “internal system of quality assurance of higher education (internal system) and its verification, establishment”. Section 3 of this Act stipulates that “a university shall ensure the quality of provided higher education by the implementation of the internal system and its continuous development”.

Furthermore, Article 25 of the Act states that “The Agency shall decide, on the basis of the results of the internal system assessment, whether or not the internal system and its implementation comply with the internal system standards”.

The assessment concerns the internal system itself, study programs, habilitation and inaugural procedures. It can be clearly stated that the existence of a university will depend on the outcome of the evaluation of the state of the “internal system” and its functionality.

By the abovementioned act, the Slovak Accreditation Agency for Higher Education is established as an independent public institution whose task is to carry out external quality assurance activities of higher education in Slovak Republic.

These facts are considered to be an important innovation element supporting the introduction of absolute primary responsibility of higher education institutions for the quality of provided higher education, which means forthcoming autonomous quality self-assessment of study programs (institutional or subject accreditation), ESG standards based on TQM principles imposing the duty to regularly draw up a self-assessment report of all activities.

According to the Act no. 269/2018 Coll. on Quality Assurance of Higher Education (2018), the Agency will decide on: (a) compliance of the internal system and its implementation with internal system standards; (b) granting or not granting accreditation of a study program; and (c) the granting of accreditation of the habilitation procedure and the inaugural procedure, not granting or withdrawing it.

A university that demonstrates the functionality of the internal quality assurance system of higher education can independently create, innovate study programs, including programs in combination of fields, as well as joint programs in study fields and degrees at which the university is entitled to create, implement and modify study programs. (Section 25 of the Quality Assurance Act).

Such a framework in the area of quality of higher education presupposes the task for Slovak universities to find new adequate ways of implementation of internal quality systems in terms of their content and processes.

## **6 STATUS OF APPLICATION OF MANAGEMENT METHODS IN SLOVAK REPUBLIC**

In this chapter, an overview of the use of management methods to measure performance in business and non-business organizations – higher education institutions in Slovak Republic will be presented. In the first case, available resources were studied and in the case of higher education institutions the results are brought out of the own survey carried out in 2016 within the project of the Ministry of Education, Science, Research and Sport of Slovak Republic in cooperation with SAAIC - entitled Support for Reform Tools in Slovak Higher Education (SIHE). In the project, the author of the paper operated as a national expert for quality management in higher education institutions.

### **6.1 Management methods to measure performance in business organizations in Slovakia**

Generally, there is no long-term research on the number and structure of performance measurement and management tools usage in Slovak Republic. The penetration of these tools into business practice in Slovakia has been much slower and less intense than abroad. In spite of this, several researches were carried out focused on management methods, tools and systems in Slovakia. Out of them, researches covering Benchmarking, Balanced Scorecard (BSC) and

application of the self-assessment method, which is used to analyse the management and organizational performance effectiveness and is mainly grasped by comprehensive (total) quality management models, will be presented.

Leon (2017) published the results of a survey from 2010 conducted in the Slovak Republic as a part of the dissertation of Karabašová regarding the use of 25 selected global management tools for business management. The research sample consisted of companies that achieved a turnover of more than EUR 5 mil. A total of 956 subjects were approached, while 110 enterprises participated in an online survey, i.e. 11.51% of the surveyed sample. The survey addressed question of an extent to which Slovak companies use and are satisfied with the 25 popular management tools for business management and performance. The results of this survey can be compared with those of Bain & Company (Rigby & Bilodeau, 2018). Balanced Scorecard, Benchmarking and Strategic Alliances in the Slovak Republic recorded the largest drop compared to the world, i.e. in Slovakia almost 40% fewer companies use these tools than those in the world. To a comparable extent, Slovak companies use the tools of Strategic Planning (difference of 1%) and Customer Relationship Management (difference of 1%). Among the top ten methods used in the world, the use exceeds only in two areas in Slovak Republic: Focus on key competencies (5% difference) and Customer segmentation (7% difference). Interesting finding has been the difference in the use of BSC in our country (8%) and in the world (47%). It is evident that Slovak companies have little knowledge of world-wide used methodology, the Balanced Scorecard.

Szabo and Nemeth (2017) published the results of their research in which application of selected traditional management tools in Slovakia was examined: Management by Objectives, Just-in-Time, Total Quality Management, Project Management, Coaching, Six Sigma and Knowledge Management. A sample of randomly selected enterprises in Slovak Republic was used as a research object. For selection of the research sample, a worldwide database of business entities, the ORBIS was used. The survey data have shown that the most used management method among the respondents included in the sample is project management. 82% of respondents use this tool in their management. Coaching, used by 66% of respondents in at least one area of management, is another traditional management tool that companies use in their management to a significant extent. The Justin-Time and Total Quality Management (TQM) tools are approximately of the same usage in corporate management in Slovakia. Just-in-Time is used by 51% of respondents and TQM by 48% of respondents. Another management tool that is used by companies in Slovakia to a significant extent is Knowledge Management. Forty five percent of respondents apply this tool in at least one management area.

Čambalíková and Szabo (2016) provided questionnaire survey on selected management methods - Customer Relationship Management, Strategic Planning, Talent Management and Benchmarking. A total of 203 enterprises took part in the questionnaire survey, of which 33% were micro-enterprises (up to 10 employees), 27% small enterprises (up to 50 employees), 18% medium-sized enterprises (up to 250 employees) and 22% large enterprises (over 250 employees).

In the course of evaluating implementation rate of selected management methods, Čambalíková and Szabo (2016) identified that managers make the most use of the strategic planning management tool, up to 72% of them. Customer Relationship Management (CRM) is used by 70% of businesses, especially in relation to customers. Benchmarking is used in practice by 55% of companies and talent management by 40% of them. As follows from this survey on question, whether managers are considering introducing also other management methods not used so far in their management work, most of them answered in the negative, up to 67% of them. The most frequently cited reasons were that they did not consider this to be necessary



(especially given the small size of the company), or that the methods and tools used so far were sufficient.

Of these surveys, the fact that 48% of the 171 business companies use self-assessment TQM models is an important matter from the point of view of this article.

## 6.2 Management methods to measure performance in higher education institutions in Slovakia

In October 2016, the project of The Ministry of Education, Science, Research and Sport of Slovak Republic in cooperation with SAAIC, the national agency for the programme Erasmus+ for Education and Training, entitled “Support for Implementation of Reform Tools in Slovak Higher Education” (SIHE, 2016) was realized by questionnaire survey focused on innovative changes in processes and their management at Slovak higher education institutions. The survey involved 22 universities shown in Figure 2 in the following ratio: 25% states universities, 70% public universities and 5% private universities.

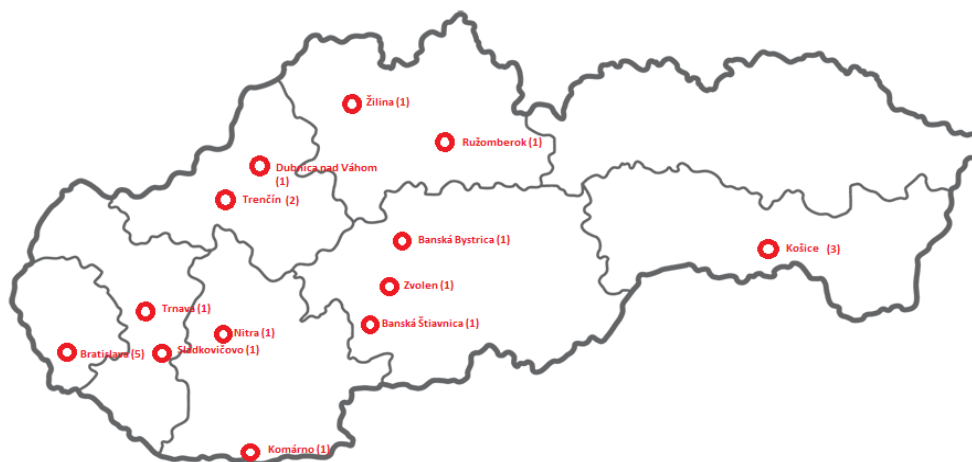

Fig. 2 – Universities involved in the survey. Source: SIHE (2016)

Based on the results of this survey, it can be stated that universities in Slovak Republic have a high degree of implementation (78.9%) of internal quality systems (Figure 4).

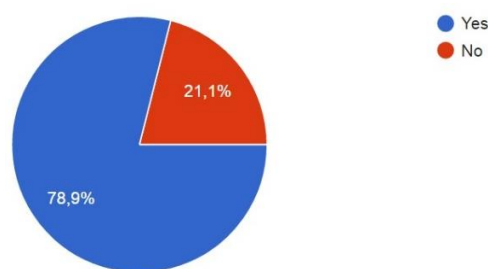

Fig. 3 – Status of implementation of quality systems at higher education institutions. Source: SIHE (2016)

Figure 4 provides an overview of implemented quality management models and Figure 5 presents the results of self-assessment report elaborations in a broader sense.

Based on the above survey, it can be concluded that the internal quality systems have been applied at a high rate, however in different forms and scope. The diversity in the implementation of the internal quality system is a positive rather than a negative thing, but the essence is that universities should implement diagnostic self-assessment based on the principles of the PDSA cycle in terms of process quality assurance. Together with the clear structure of the individual steps, respectively, the phases of the PDSA cycle, a functional, transparent and dynamic system

will be set up to achieve the aims and objectives of higher education institutions in the area of process quality assurance of higher education.

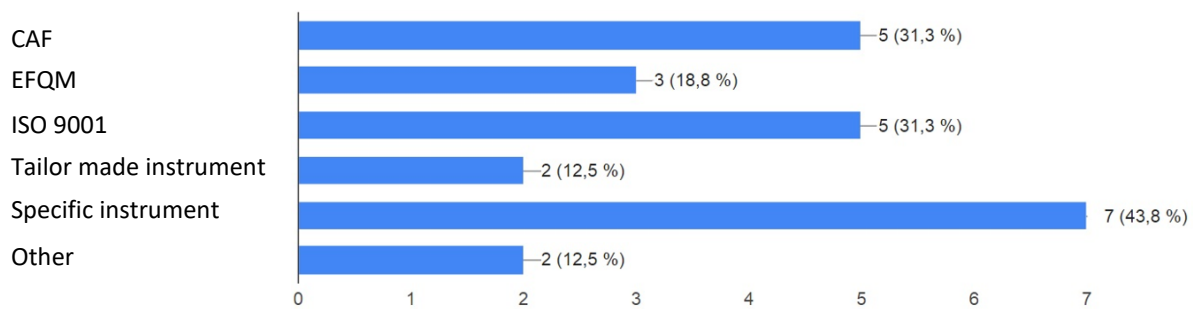

Fig. 4 – Overview of implemented quality management models at universities in Slovakia. Source: SIHE (2016)

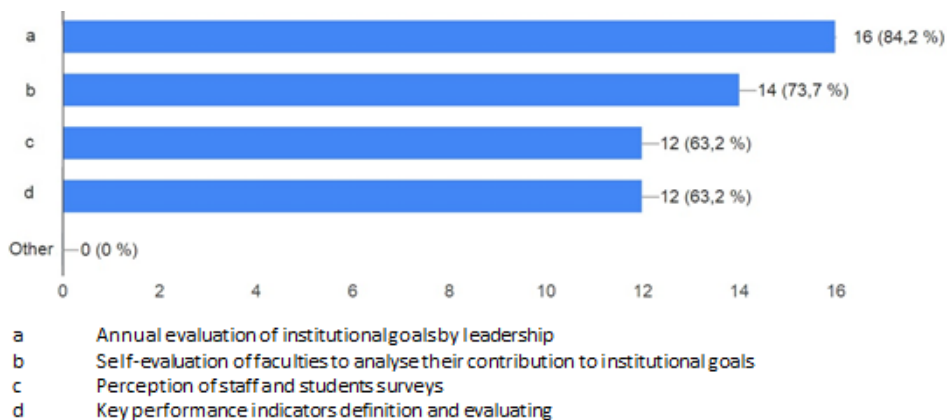

Fig. 5 – Overview of self-assessment at universities in Slovakia. Source: SIHE (2016)

## 7 ACTUAL CHALLENGE FOR HIGHER EDUCATION INSTITUTIONS IN SLOVAK REPUBLIC

Although the quality assurance (management) and evaluation (verification) elements are already present to a varying degree in higher education, the crucial task will be to further develop and complement them so as to create a meaningful, functioning, efficient and, at the same time, outwardly transparent system in terms of two equivalent aspects: content and process.

The method of implementing the content of the internal quality system for higher education institutions set up under the new legal rules in Slovak Republic corresponds to the terms 'quality assurance' or 'quality management'. The implementation of the procedural aspect of the internal quality system for higher education institution corresponds to the terms “quality verification” or “quality evaluation”. In this context, the internal system of quality assurance (management) and verification (evaluation) of higher education and related activities can be understood as a set of principles, rules and procedures that verify compliance with minimum quality requirements and create scope for their development, improvement and innovation. Analysis of good practice in management methods to measure performance in business organization can be considered for the application in higher education institutions in terms of procedural aspect of the internal quality management system.

### 7.1 Internal quality management system – content

The content of higher education quality assurance is known in the Slovak Republic. The ESG 2015, the Quality Assurance Act and a number of other criteria and indicators elaborated in

publications or project outputs and covering several areas related to education, such as internationalization, student-centred learning, or increasing the competence of university teachers provide a fundamental framework in this area. In line with the Quality Assurance Act, the portfolio of indicators will be extended to standards for internal systems to be adopted by the Slovak Accreditation Agency (SAA) in the upcoming period (at the end of 2019). The scientific and research area are governed by specific criteria and the criteria for related activities follows from indicators for education and scientific and research activities. All these criteria and indicators ensure minimum quality requirements. However, it is desirable for higher education managers having the ambition to achieve institution excellence by extending these criteria with their own indicators, which will ensure development in the area and will add value and specificity to higher education (Univerzita Karlova, 2019). This view is reflected in Figure 6 in terms of all three higher education institutions key functions interacting with each other, as well as in terms of minimum requirements and requirements for further development of quality at universities.

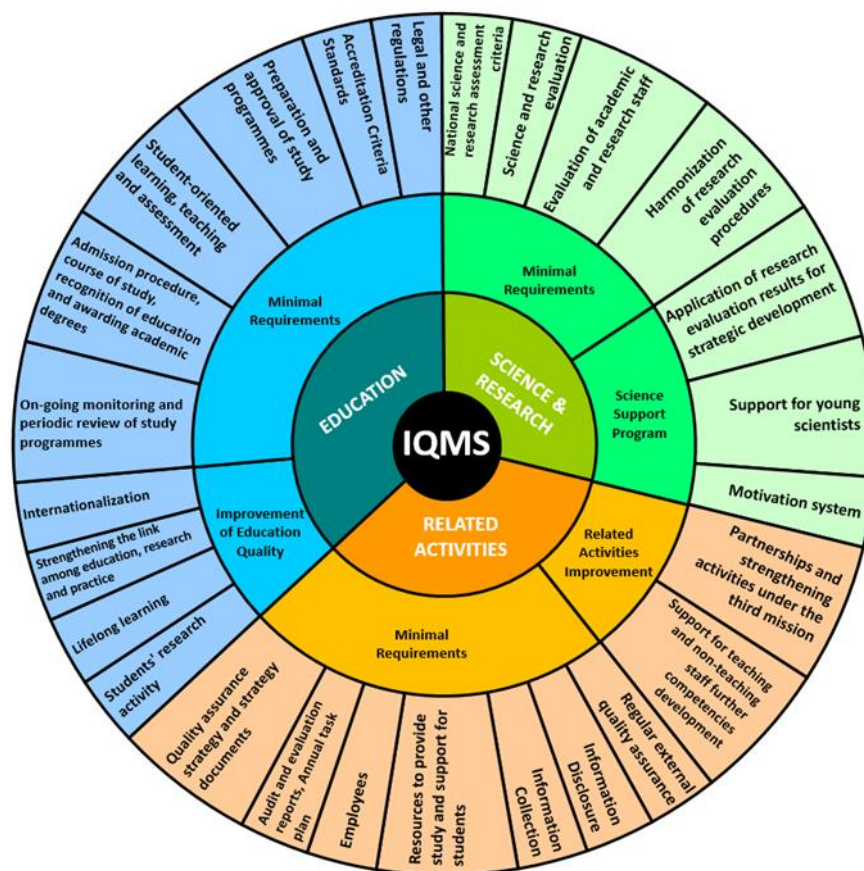

Fig. 6 – Internal Quality Assurance Content Model for Higher Education Institution. Source: own research

## 7.2 Internal quality management system – procedural aspect and self-assessment

Within the procedural aspect, i.e. the verification (evaluation) of the quality of higher education and related activities, an important tool is a diagnostic self-assessment based on the principles of the PDSA's Deming Cycle and processed into a self-assessment report based on a pre-established framework curriculum. Based on the diagnostic self-assessment, the university formulates new impulses for its improvement, which then translates into strategic plans and improvement documents.

One of general definitions of self-assessment states: “An organization may use self-assessment to identify improvement and innovation opportunities, to identify priorities and to develop

action plans for sustainable success. Self-assessment also has the potential to become an educational tool that can provide an improved vision of the organization and encourage stakeholder involvement”.

According to Conti (2001), self-assessment aimed at performance improvement, called “diagnostic self-assessment” has historically arisen from quality prizes awarding and has relatively early proven to be much more important as an improvement initiation mean than the prizes themselves. This type of self-assessment has also undergone some development. At first, the self-assessment of this kind has been only one of internal audit forms. In the further development, there was a gradual shift in importance between the diagnostic and point score assessment in favour of the diagnostic aspect.

The PDSA (Plan / Do / Study / Act) cycle, or Deming Cycle is a systematic series of multiple types of operations to obtain the information needed to continuously improve quality assurance processes. The author of the initial version (PDCA-Plan / Do / Check / Act) and the modified version of PDSA is William Edwards Deming, a well-known American statistician (Kuktelionis, 2019). The cycle begins with the Plan step, which includes identifying the goal or purpose, formulating the theory, defining success metrics, and activating the plan. These activities are followed by an implementation step (Do) in which the components of the plan are implemented, such as introducing new activities into internal regulations. This is followed by a Study step in which results are tracked to test the validity of a plan to identify progress and success, or problems and areas for improvement. In this third step, the self-assessment is carried out. The Act completes the cycle, integrating learning created by the whole process, which can be used to tailor a goal, change methods or even reformulate theories and strategies. These four steps are continually repeated as part of an endless cycle of continuous improvement.

The current trend of raising the need for higher education institutions to seek new ways of ensuring quality of education provided, both in terms of content and process, is a positive trend.

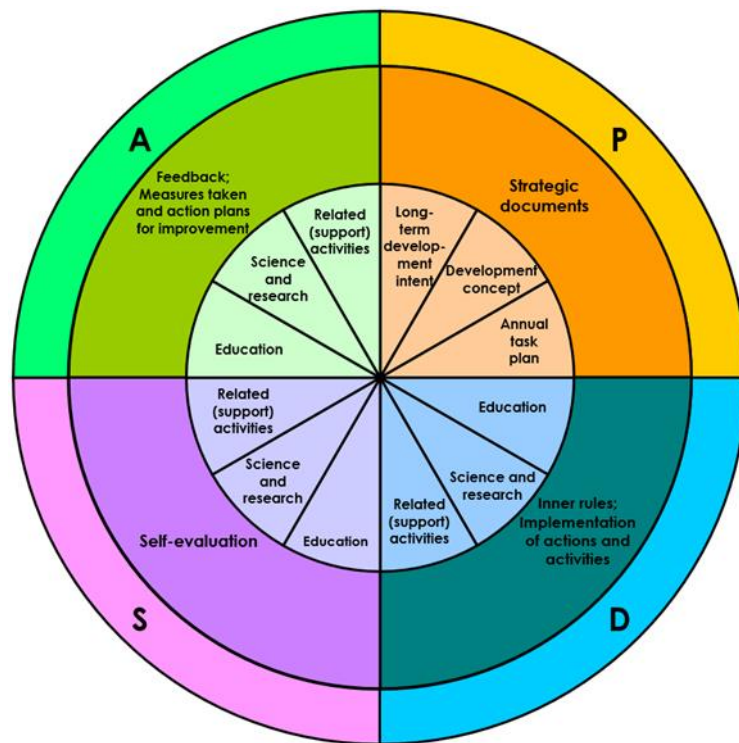

Fig. 7 – Internal Quality Evaluation Procedural Model for Higher Education Institution. Source: own research

From a procedural point of view, the introduction of regular diagnostic self-assessment of processes ensuring the monitoring of the three main functions of the university - education, research and creative activity and related activities, including the so-called 'third mission', is an important management tool of quality assurance. Implementation of diagnostic self-assessment based on the Deming's PDSA cycle principles and elaborated into a self-assessment report based on a pre-established framework outline provides university managers with a stable tool and a dynamic internal assessment framework of minimum quality assurance requirements compliance, while supporting improvement and development of university's core functions and thereby its excellence. Based on the diagnostic self-evaluation, the university formulates new impulses for its development, which is then translated into strategic plans and development documents.

## 8 DISCUSSION

The main findings of this study is the fact that when implementing internal quality systems at universities, it is desirable to rely on the principles of Total Quality Management; and that it is appropriate to be inspired by management approaches in a non-business environment.

Starting from the classic definition of the term "quality" by Harvey and Green (1993), a systematic study the Bologna declaration content, as well as publications and studies of institutions supporting implementation of the elements of this Declaration, the author of this paper support the view that the essence of the "higher education quality" is in the search for basic balance of all major education institutions activities. Quality assessment at higher education institutions with a clear preference for research and academic publishing performance assessment currently requires setting up balance of the three key functions of higher education - education, science, research and art, as well as related activities (support activities and the social role of universities – called "Third mission"). It is necessary to focus principally on the historically primary function of the university - educational, which is currently underestimated.

A return to this balance is necessary, in particular, with regard to the requirements of efficiency in the use of public resources, the principle of equal access to education, social responsibility, globalization and internationalization. On the one hand, university management as well as academic staff have adapted to the shift in the evaluation criteria towards scientific and research performance, but on the other hand, especially in recent times, they have identified a certain shortcoming in this shift. A strong pressure to be a credible partner for interested parties, clients taking the graduates, arises. Conditions for the students have to be assured by universities so that they can use adequate learning outcomes and achieve personal development enabling relevant employment in the current economic and social environment.

However, even in this situation, any of the three so highly interconnected functions of a higher education institution cannot be underestimated or undervalued, and in focusing on the quality of education, the second two functions cannot be redelegate to be secondary in a comprehensive (total) quality management. Assurance, respectively the management of quality of a higher education institution must cover all its functions, education, research and related activities.

At the same time, internal quality management systems should be designed so that they are able to achieve objectives leading to fulfillment of minimum requirements and, in the case of ambitious intentions of the higher education institution, they should be an instrument for excellence.

The quality assurance and evaluation elements are already present to a varying degree in higher education, the crucial task will be to further develop and complement them so as to create a

meaningful, functioning, efficient and, at the same time, outwardly transparent system in terms of two equivalent aspects: content and process.

Therefore, the author of this paper proposes a possible solution for the implementation of the quality management system at the university (Fig. 6 and Fig. 7), which can be used in policy-making at the national level and in the application at the university.

The strength of this paper is the design of the quality management model at the university. The weakness is that the research is preliminary, because a comprehensive theoretical evaluation of qualitative research will be carried out using software in the final stage of the author's dissertation.

## 9 CONCLUSION

The issue of effective university management with the aim of increasing its competitiveness is an essential element in the current breakthrough period of the ongoing reform of higher education in Slovak Republic. The current transformation of higher education institutions in Slovak Republic will be reflected in management approach change of these non-business sector organizations. In this sense, we can talk about management or organizational innovations. Higher education institutions are looking for the ways and possibilities of using management methods as tools for improving the institution's performance, with an emphasis on improving the quality of education. This is a major challenge for management, as the reform process initiated is still incomplete.

Based on extensive theoretical background, knowledge of the organization and management of higher education institutions and experience in implementing a comprehensive quality management model in such an organization, author of this contribution is convinced that the management methods used in long term manner in business-type organizations are possible, appropriate, even desirable to apply in non-business organizations - higher education institutions. Of them, the self-assessment method is considered by the author to be an innovative and effective management tool for improving performance in higher education institutions in Slovak Republic.

In order to support this view, the author of this paper contributes to the development of approaches to the governance of higher education institutions by presenting her own concept of a chosen method - self-assessment. The choice of the self-assessment method is supported by the fact that it is part of a key document for improving the quality of education in the EU Member States - Standards and Guidelines for Quality Assurance in the European Higher Education Area (ESG, 2015). At the same time, the paper pays attention to the fact that, when implementing a quality management system in higher education institution, it is necessary to focus the activities of management consciously on two equal areas, namely content and process.

Project SIHE realized with contribution of the author of this paper showed that self-assessment in a broader context and in different forms and scope is carried out in Slovak republic. However, the Slovak universities expect a further support for the changes in management approach from the supervisor at the national level. By proper implementation of the internal quality system, with a clear procedural structure of interrelations between the internal quality system, internal system standards, financial criteria, standards and guidelines for quality assurance in the European Higher Education Area (ESG 2015) and new national legislation, positive changes in education and thus increase in competitiveness of Slovak universities can be expected.



## References

- Act no. 131/2002 Coll. on Higher Education (2019). *Zákon č. 131/2002 Z. z. o vysokých školách a o zmene a doplnení niektorých zákonov*. Retrieved from <https://www.slov-lex.sk/pravne-predpisy/SK/ZZ/2002/131/20191113.html>
- Act no. 269/2018 Coll. on Quality Assurance of Higher Education (2018). *Zákon č. 269/2018 Z. z. o zabezpečovaní kvality vysokoškolského vzdelávania a o zmene a doplnení zákona č. 343/2015 Z. z. o verejnom obstarávaní a o zmene a doplnení niektorých zákonov v znení neskorších predpisov*. Retrieved from <https://www.slov-lex.sk/pravne-predpisy/SK/ZZ/2018/269/20181101>
- Conti, T. (2001). *Why most companies do not get the most out of their self-assessments*. Paper presented at the ASQ World Conference on Quality and Improvement 2001, Milwaukee, USA. Milwaukee: American Society for Quality. Retrieved from <http://asq.org/qic/display-item/index.html?item=14697>
- Čambalíková, A., & Szabo, I. (2016). *Moderné trendy v manažmente*. Paper presented at Ekonomika, financie a manažment podniku X., Bratislava, Slovakia. Bratislava: EKONÓM. Retrieved from [http://fpm.euba.sk/www\\_write/files/veda-vyskum/zborniky-vedeckych-stati/2016.pdf](http://fpm.euba.sk/www_write/files/veda-vyskum/zborniky-vedeckych-stati/2016.pdf)
- ENQA (2013). *European Association for Quality Assurance in Higher Education*. Retrieved from <https://enqa.eu/>
- EQA (n.d.). *European Quality Assurance Register for Higher Education*. Retrieved from <https://www.eqar.eu/>
- ESG (2015). *Standards and Guidelines for Quality Assurance in the European Higher Education Area*. Retrieved from [https://enqa.eu/wp-content/uploads/2015/11/ESG\\_2015.pdf](https://enqa.eu/wp-content/uploads/2015/11/ESG_2015.pdf)
- ESU (n.d.). *European Students' Union*. Retrieved from <https://www.esu-online.org/>
- EURASHE (n.d.). *European Association of Institutions in Higher Education*. Retrieved from <https://www.eurashe.eu/>
- European Commission (n.d.). *The Bologna Process and the European Higher Education Area*. Retrieved from [https://ec.europa.eu/education/policy/higher-education/Bologna-process\\_en](https://ec.europa.eu/education/policy/higher-education/Bologna-process_en)
- EUA (n.d.). *European University Association*. Retrieved from <https://eua.eu/>
- Harvey, L., & Green, D. (1993). Defining Quality. *Assessment and Evaluation in Higher Education*, 18, 9-34. doi: 10.1080/0260293930180102
- Galáš, P. (2017). *Tajomstvo zlatého rezu. Analýza riadenia a samosprávy vysokých škôl*. Inštitút vzdelávacej politiky, Ministerstvo školstva, vedy, výskumu a športu SR. Retrieved from <https://www.minedu.sk/data/att/12045.pdf>
- Jakubeková, M., Paulová, I., & Zgodavová, K. (2014). *Procesný prístup k zvyšovaniu kvality riadenia školy*. Bratislava: Metodicko-pedagogické centrum. Retrieved from [https://mpc-edu.sk/sites/default/files/publikacie/jakubekova\\_procesny\\_prístup\\_\\_\\_\\_.pdf](https://mpc-edu.sk/sites/default/files/publikacie/jakubekova_procesny_prístup____.pdf)
- Katic, D., Majstorovic, V., & Colak, I. (2011). Performance Measurement Review. *Annals of DAAAM & Proceedings 2011*, 22(1), 515-516. Retrieved from [https://www.daaam.info/Downloads/Pdfs/proceedings/proceedings\\_2011/0515\\_Katic.pdf](https://www.daaam.info/Downloads/Pdfs/proceedings/proceedings_2011/0515_Katic.pdf)

- Kuktelionis, C. (2019). *Always Improve: Using PDSA Cycles*. Huron Consulting Group. Retrieved from <https://www.studereducation.com/always-improve-using-pdsa-cycles/>
- Leon, R. D. (2017). *Managerial Strategies for Business Sustainability during Turbulent Times*. Hershey: IGI Global.
- Mohelská, H., & Pitra, Z. (2012). *Manažerské metody*. Praha: Professional publishing.
- Rigby D., & Bilodeau, R. (2018). *Management tools and trends*. Boston: Bain & Company. Retrieved from [https://www.bain.com/contentassets/caa40128a49c4f34800a76eae15828e3/bain\\_brief-management\\_tools\\_and\\_trends.pdf](https://www.bain.com/contentassets/caa40128a49c4f34800a76eae15828e3/bain_brief-management_tools_and_trends.pdf)
- Searles, B., Mann R. S., & Kohl, H. (2013). *Benchmarking 2030: The Future of Benchmarking*. Retrieved from [https://www.bpir.com/images/PDFs/GBN/gbn-report\\_bm2030\\_final\\_web.pdf](https://www.bpir.com/images/PDFs/GBN/gbn-report_bm2030_final_web.pdf)
- SIHE (2016). *Support for Implementation of Reform Tools in Slovak Higher Education*. The project of the Ministry of Education, Science, Research and Sport of Slovak Republic in cooperation with Slovak Academic Association for International Cooperation.
- Szabo, L., & Nemeth, F. (2017). Frekvencia uplatňovania tradičných a moderných manažerských metód, techník a nástrojov v podnikoch na Slovensku. *Ekonomika a manažment*, 14(2), 8-32. Retrieved from [https://fpm.euba.sk/www\\_write/files/veda-vyskum/ekonomika-a-manazment/EaM\\_2\\_2017\\_.pdf](https://fpm.euba.sk/www_write/files/veda-vyskum/ekonomika-a-manazment/EaM_2_2017_.pdf)
- Univerzita Karlova (2019). *Zajišťování a vnitřní hodnocení kvality: Systém zajišťování a vnitřního hodnocení kvality Univerzity Karlovy*. Retrieved from <https://cuni.cz/UK-4058-version1-system.pdf>
- Vouldis, A., & Kokkinaki, A. (2011). *A critical review of business performance models and frameworks and their application to sales organization*. Paper presented at the 3rd European Conference on Intellectual Capital, Nicosia, Cyprus. Cyprus: Academic Conferences and Publishing International.

## Contact information

**PhDr. Adriana Krupová**

School of Management in Trenčín  
 Bezručova 64, 91101, Trenčín, Slovak Republic  
 E-mail: [adriana.krupova@truni.sk](mailto:adriana.krupova@truni.sk)  
 ORCID: 0000-0002-3825-0019

doi: 10.7441/dokbat.2019.059



# CORPORATE SOCIAL RESPONSIBILITY (CSR) REFLECTED IN ADVERTISEMENT ACTIVITIES

*Martin Kuchta, Monika Stankova, Maria Hasprova*

## **Abstract**

Corporate social responsibility (CSR) approaches in marketing messages has great potential to change people and society in positive ways. The main aim of the paper is to evaluate what percentage of advertisement on the Czech and Slovak market has a socially responsible character. The primary research method of the paper is a quantitative research with the qualitative elements. The authors of the paper evaluated marketing campaigns signed to the biggest advertisement contests on the markets. Authors identified, whether an observed campaign has a CSR character or not. The research also contains the hypotheses, whether a country of origin and a contest type have a significant influence on CSR elements in advertisements. Hypotheses were evaluated via statistical analyses in SPSS software and findings supported solution of the main aim. Results of the research confirmed, that country and contest type have a moderate or relatively strong effect on CSR occurrence and final findings uncovered, that despite the fact CSR activities have positive effects on firms in many ways, its potential is untapped.

*Keywords: advertisement, corporate social responsibility, CSR, marketing, social responsibility*

## **1 INTRODUCTION**

Marketing and advertisement activities became an inherent part of a financial planning of the most of nowadays firms (Aggarwal, Aggarwal & Jha, 2014). Creation of a brand position in minds of consumers is a crucial element for gaining a competitive advantage on overcrowded markets (Beverland, Napoli & Farrelly, 2010). A firm and its marketing and advertisement activities often carry message, which has a great reach and is consumed by a significant number of consumers. Mission statements and memos, policies, and procedures all highlight the importance of staying in touch with the customer (Atuahene-Gima, 1995). A firm has to correctly choose what message it wants to deliver and what target group it should reach. It is important to carefully consider an impact of the message, because due to a great reach it has a potential to influence opinions and perceptions of targeted people.

Thus, marketing and advertisement activities of firms have a potential to change society and people in a positive way. Corporate social responsibility (CSR) is a marketing and an advertisement approach, which can strengthen profitability, improve accountability, enhance employee commitment, decrease vulnerability and improve reputation of a firm. Due to positive impact of CSR activities on common properties and areas they could be in some cases even supported by governances (Aguinis, Edwards & Bradley, 2017). Once a firm decides to create a CSR campaign, it has to make a decision about what media channel it will be carried through. The analysis of Boccia, Malgeri Manzo and Covino (2019) shows a positive relationship between socially responsible initiatives of companies and attitudes of consumers towards them and their products.

There are many possibilities how to set a marketing and advertising strategy and effective combination of digital channels can have positive impact on financial costs and effectiveness of a campaign (Rodriguez, Rubio & Rabanal, 2016). It is often a responsibility of a marketing

strategist to combine proper media channel mix to reach as many users from a target group as possible (Cambra-Fierro et al., 2011).

## **2 LITERATURE REVIEW**

### **2.1 Available media channels**

According to (Snyder & Garcia-Garcia, 2016), “the evidence overwhelmingly points to higher ROI (Return of Investment) from advertising on multiple platforms, than advertising on a single platform only.” Current media markets offer several channels, which might be used as a distribution channel for marketing messages. Authors of the paper according to research of Vilčeková (2016) identified five crucial media channels, which are being used in marketing communication strategies of firms: (1) television; (2) radio; (3) print; (4) OOH (Out Of Home); and (5) internet. Obviously, every of the channel has its own subcategories and it is possible to diversify it in many ways. However, the five channels are most commonly used also in media and financial planning of the most of firms. The categorisation is also confirmed by eMarketer (2018), which is considered as one of the most relevant subjects in marketing research area.

Every firm with marketing activities has to correctly define its target group and identify which of the five channels has the highest potential for reaching potential consumers. Optimal allocation of advertising investments has a great potential to maximize campaign recognition (Goos et al., 2019). Consumer perception researches point to effectiveness of coordinated media campaigns which utilize several platforms. The use of at least two media channels has a positive impact on a brand memorability (Edell & Keller, 1989). Thus, firms should create a mix of media channels with a focus on investment effectivity and reaching a target group. Current marketing architecture works with cross-platform advertising, which utilizes various advertisement channels (Neijens & Voorveld, 2015). A socially oriented companies can successfully leverage their reputation to market products with high symbolic values (Castaldo et al., 2009).

### **2.2 Corporate social responsibility**

Once a firm decides to invest into a marketing communication, it has to make a decision about what communication message it wants to deliver to a defined target group and in what way it will deliver the message. There are many creative ways a firm can choose from. Marketing is a creative industry and the ways, how to give an information, are almost endless.

Currently, very frequent, and also from customers demanded way, is to create socially responsible marketing activities, which have, in some way, positive impact on society. According to Kotler (2007) socially responsible marketing is represented by marketing and advertising activities which, in some way, help to solve a negative situation connected to environmental problems, lack of non-renewable sources, pollution, important society questions, etc. The CSR activities among retailers are likely to positively affect retailer brand image (Loussaïef et al., 2014). Due to theoretical part of the research of Copuš, Papík and Olšavský (2017) a societal marketing stands on three pillars, which should reflect: (1) society – human prosperity; (2) consumers – meeting consumer needs; and (3) company – profit.

Societal marketing and corporate social responsibility (CSR) activities should meet society needs, consumer preferences, motivate employees and satisfy firm’s goals (Hur, Moon & Ko, 2018). A task should be accomplished by product managers and marketing strategists within a firm. For such a task it is necessary to find a motivation. “Corporations can be motivated to change their corporate behaviour in response to the business case which a CSR approach potentially promises. This includes: (a) stronger financial performance and profitability (e.g.

through eco-efficiency); (b) improved accountability to and assessments from the investment community; (c) enhanced employee commitment; (d) decreased vulnerability through stronger relationships with communities; and (e) improved reputation and branding (Saha, 2016).

Socially responsible marketing “presents the development of a marketing philosophy, discusses the influence of consumerism on the marketing concept and deals with ethics and social responsibility in marketing. It is argued that organisations who adopt the societal marketing concept will be the ones most likely to make long-run profits as well as to be beneficial to society as a whole” (Abratt & Sacks, 1988). “In a market in which a segment of consumers is sensitive to product quality and consumers' brand choice in low-involvement packaged goods categories is characterized by inertia, the quality store brands can be an instrument for retailers to generate store differentiation, store loyalty, and store profitability, even when the store brand does not have a margin advantage over the national brand” (Corstjens & Lal, 2000). Socially responsible marketing has a positive impact on brand building and can lead to effective building of relationship between a consumer and a brand. Massive marketing communication with socially responsible aspect can even lead to a change of laws that can support well-being of social communities (Alday et al., 2010).

Due to study of Ha-Brookshire and Hodges (2009), a lot of consumers feel guilt when indulge utilitarian and hedonic purchase behaviour connected to excessive purchases. Socially responsible image of a brand or a specific product can ease the feel and strengthen a purchase potential even within socially responsible or activist consumers target groups (Carpenter, Moore & Fairhurst, 2005).

Socially responsible marketing activities can be categorized into four main areas: (1) Environmental sustainability initiatives – the area focuses on limiting pollution and reducing greenhouse gases. However, coverage of the area can be much more spread and can also touch a sustainability of animal species, prevent extinction of plant species etc.; (2) Direct philanthropic giving – a situation, when a firm donates voluntary amount of financial sources to a non-profit organization, civic association or other socially responsible and help a giving subject; (3) Ethical business practices – firm focuses on good conditions for employees and is trying to create fair business conditions for every subject in a trade chain. Except socially responsible marketing effect, such a business activity can also correspond with Fair Trade form of business; and (4) Focus on economic responsibility – finding a balance between economically prosperous decisions and their overall effect on society, nature and sustainability. For some types of businesses is the area easier than for another, however every business decision can be made regarding environmental and sustain motives (Krohn, 2018).

The findings in study of Rahman, Rodríguez-Serrano and Lambkin (2017) demonstrate that the level of advertising intensity positively moderates the relationship between CSR and market share. Thus, socially responsible marketing reflected in advertising activities is shown as one of the most effective strategies, how to create socially responsible brand of a firm. The question is, how many firms and their marketing departments realize this and how it is reflected in executed advertising campaigns.

### **3 METHODOLOGY**

Research of existing theoretical sources and already conducted studies refers to importance of CSR as important growth strategy for firms. Investments into environmental, philanthropic, ethical or economically responsible issues have a positive impact on creation of a relationship between a brand and a consumer. In addition, such responsible behaviour has a positive impact on future revenues. One of the many possibilities how to communicate socially responsible business direction is through an advertisement. Research of existing sources identified research

gap, which do not consider and analyse how socially responsible activities are reflected in executed advertisement activities of firms. The main aim of the article was to evaluate what percentage of advertisement has a socially responsible character.

As a primary research method, a utilized quantitative research of executed advertisements across the Czech and Slovak market was used. In the beginning we identified the most relevant advertisement contest FLEMA 2019, which contains marketing campaigns from Czech and Slovak market. However, sample was too small to use statistical research methods, so to spread the sample we identified the second most relevant advertisement contest EFFIE 2019 on the Slovak market. Thus, we effectively spread the sample and covered both markets, which are very similar in marketing and advertisement approaches. Both of the contests have very similar rules and both of them are annual. The main goal of the contests is to collect the most relevant and the most impactful ads through the markets, evaluate them in defined categories and find winners in defined sections. FLEMA (2019) had 58 registered campaigns and EFFIE (2019) had 39 registered campaigns. Some of them were duplicated. All campaigns were rated by almost 200 specialists from a marketing field.

Authors of the paper gained access into evaluation interface of the both contests and evaluated all signed advertisements from a juror position. For evaluation purposes an extensive table containing several fields which were evaluated, was created. In line with theoretical research categories were: (a) business field of an advertisement; (b) country where an advertisement took primary place; (c) brand, which an advertisement executed; (d) media type where an advertisement took primary place; and (e) CSR dimension, which evaluated if an advertisement had some CSR element.

Due to utilization of data from two contests, we also wanted to test, if the contest type has an influence on CSR element in a campaign. One contest could due to its character lure more CSR campaigns than another. We set hypotheses:

*RH1: H0: There is no significant association between the contest type and the CSR occurrence.*

*RH1: H1: There is a significant association between the contest type and the CSR occurrence.*

We also wanted to test if a country of contest has an influence on CSR element in a campaign. We set the following hypotheses:

*RH2: H0: There is no significant association between the country and the CSR occurrence.*

*RH2: H1: There is a significant association between the country and the CSR occurrence.*

To evaluate the correlation in defined hypotheses, Pearson's Chi-square test of independence was conducted. To evaluate the strength of the association between the two variables, the effect size of Phi and Cramer's V was utilized. The tests were conducted in statistical software SPSS. The research was conducted in September and October 2019 and the collected data was processed at the end of October 2019. Advertisements were researched before the contests events were conducted, thus before official results of the contests were presented.

## **4 RESULTS**

The first step of the research was a development of extensive table, which contains all needed data for evaluation of advertisement signed into FLEMA and EFFIE contest. Data contained in the table are based on the categorization within an interface of evaluation online system of the contest. All advertisements were evaluated from a juror point of view. All the data collected and evaluated in the table was subsequently processed into graphs for a better visual and text

interpretation. 75 campaigns from 14 different brands participating in the annual contests FLEMA and EFFIE were evaluated (Table 1).

Tab. 1 – The overview of the contests campaigns. Source: FLEMA (2019), EFFIE (2019)

No	FLEMA	EFFIE	Business field	CZ	SR	Brand	Campaign name	Internet	TV	Radio	Print	OOH	CSR
1	1	0	FMCG	1	0	Pilsner Urquell	Pilsner Urquell - Všichni jsme národák	1	0	0	0	0	0
2	1	0	Cosmetics	0	1	Nivea	Nivea - Ako nám dáta pomohli nájsť favoritku kampane	1	0	0	0	0	0
3	1	0	FMCG	1	0	Penny Market	Penny Market - 100% designu, 0% plastu	1	1	0	0	0	1
4	1	0	Online service	1	0	Chance	Chance - #jsemchorvat	1	0	0	0	0	0
5	1	0	FMCG	1	0	Pedro	Moje PEDRO - Relaunch české tradiční značky	1	1	0	0	1	0
6	1	0	Banking	1	0	Česká spořitelna	Česká republika - George	1	1	0	1	1	0
7	1	0	FMCG	1	0	Gambrinus	Gambrinus - Honimír, Nahák & další postrachové piva	1	0	0	0	0	0
8	1	0	NPO	1	0	Člověk v tísni	Člověk v tísni - Zadlužené děti	0	0	0	0	1	1
9	1	0	Finance	1	0	Provident	Provident - Malá pomoc může odstartovat velké změny!	1	1	0	0	1	0
10	1	0	Telecommunication	0	1	O2 Slovakia	O2 Slovakia - Nebuď pirát	1	0	0	0	0	1
11	1	0	Banking	0	1	SS	Slovenská sporiteľňa - Sme moderní	1	0	0	0	0	0
12	1	0	Fashion	1	0	Bellinda	Bellinda - Cool&Sneakers style	1	0	0	0	0	0
13	1	0	Fast food	1	0	McDonald's	McDonald's - Lokální online marketing	1	0	0	0	0	0
14	1	0	FMCG	1	1	Coca-Cola	Coca-Cola - Osvěžení pravidel	0	1	0	0	0	0
15	1	0	Automotive	0	1	ŠKODA Auto	ŠKODA - Hokej nás spája už 27 rokov	0	0	0	0	1	0
16	1	0	Fast food	0	1	Burger King	Burger King - #PREPACMEKAC	1	0	0	0	0	0
17	1	0	Banking	1	0	Raiffeisenbank	Reiffeisenbank - Největší trojka na největší budově	1	1	1	1	1	0
18	1	0	Banking	1	0	Air Bank	Air Bank - Onboarding aneb jak jsme zrychlili akvizici zákazníkovi o 27%	1	1	1	0	1	0
19	1	0	FMCG	1	0	Bohemia	Bohemia - #VJEDNOMDRESU chutná líp	1	1	0	0	1	0
20	1	0	Cosmetics	0	1	Rexona	Rexona - Kúpeľňové vojny	1	0	1	0	0	0
21	1	0	Online service	1	0	FLOWEE	FLOWEE - MÁMA NENÍ DOMA, YOU TUBE ANO	0	0	0	0	1	0
22	1	0	Cosmetics	1	0	AXE	AXE - Kurz sebevědomí	1	0	0	0	0	0
23	1	0	FMCG	1	0	Rauch My Tea	Rauch - Staň se hvězdou s MyTea	1	0	0	0	0	0
24	1	0	Banking	0	1	PSS	Prvá stavebná sporiteľňa - PSS už nerobí kompromisy	1	0	0	0	0	0
25	1	0	FMCG	1	1	Fanta	Fanta+GoGo: Vyšťav úsměv!	1	0	0	0	0	0
26	1	0	Household	0	1	Domestos	Domestos pre školy	1	0	1	0	0	0

27	1	0	Telecommunication	0	1	O2 Slovakia	O2 Slovakia - Bez okuliarov tomu nič chýba	1	0	0	0	1	0
28	1	0	FMCG	0	1	Coca-Cola	Coca-Cola - WOW zážitky	1	0	0	0	0	0
29	1	0	FMCG	0	1	Birell	S Birellom nenafúkaš	0	1	1	0	1	1
30	1	0	FMCG	1	1	Chupa Chups	Chupa Chups - LOLOLOCHALLENGE: Ukáž, ako lížeš!	1	0	0	0	0	0
31	1	0	FMCG	1	1	Gambrinus	Gambrinus vs. David Copperfield	1	1	0	0	0	0
32	1	0	Telecommunication	0	1	Orange	ORANGE - Prekonanie navýšených cieľov predaja paušálov cez e-shop v druhom polroku 2018	1	0	0	0	0	0
33	1	0	FMCG	1	0	Gambrinus	Gambrinus, na ďalších 150 let	0	0	0	0	1	0
34	1	0	Cosmetics	1	1	Nivea	Nivea Men Deep	1	0	0	0	0	0
35	1	0	FMCG	0	1	Zlatý Bažant	Zlatý Bažant '73 z Černobyľu	1	0	0	0	0	0
36	1	0	Furniture	1	1	IKEA	Zkuste byť rýchlejší než IKEA	1	0	0	0	0	0
37	1	0	Electronics	0	1	SAMSUNG	SAMSUNG - Chatbot v banneri	1	0	0	0	0	0
38	1	0	Banking	0	1	SS	Slovenská sporiteľňa - Posledný billboard	1	0	0	0	1	1
39	0	1	FMCG	1	1	The Coca-Cola Company	#CokeRulez	0	1	0	0	0	0
40	0	1	FMCG	0	1	Liptov	Nečakane dobré kombinácie	1	1	0	0	1	0
41	0	1	FMCG	0	1	Plzeňský Prazdroj Slovensko	S Birellom nenafúkaš	0	1	1	0	1	1
42	0	1	FMCG	0	1	Absolut - Pernod Ricard Slovakia	Slovensko žije všetkými farbami	1	1	0	0	1	1
43	0	1	Finance	0	1	Tatra banka	Ako dokáže zmena exekúcie zvýšiť predaje nezmeneného produktu?	1	0	0	0	0	0
44	0	1	Finance	1	1	Československá obchodná banka, a.s.	Sova, nová tvár ČSOB	1	1	0	0	1	0
45	0	1	Finance	0	1	O2 Slovakia	O2 Internet na doma	1	1	1	0	0	0
46	0	1	Finance	0	1	VÚB Banka	Terapia šetrením	1	1	0	1	1	1
47	0	1	Finance	0	1	UniCredit Bank Czech Republic and Slovakia	U konto – bežný účet, ktorý dáva ľuďom to, na čom im záleží	1	0	0	0	0	0
48	0	1	Finance	0	1	Poštová banka	Vitajte v roku 2019	1	0	0	0	0	0
49	0	1	Finance	0	1	Poštová banka	Čudnejšie ako čudné	1	1	0	0	0	1
50	0	1	Telecommunication	0	1	Slovak Telekom, a.s.	Aktivuj si leto	1	1	0	0	0	0
51	0	1	Electronics	0	1	Siemens Healthcare s.r.o.	Kód, ktorý zachraňuje životy	1	0	0	0	0	1
52	0	1	Banking	0	1	Poštová Banka	Dress release	1	0	0	1	0	0
53	0	1	Automotive	0	1	DeutschMann Internationale Spedition	Robim na vychodze	1	0	0	0	1	1
54	0	1	NPO	0	1	Liga proti rakovine SR	Na koho myslíš, keď si pripínaš narcis?	1	0	1	1	0	1
55	0	1	NPO	0	1	Depaul Slovensko	Adoptuj si posteľ	1	0	0	0	0	1
56	0	1	NPO	0	1	Broz	Privítajte s nami migrantov!	1	0	0	0	0	1
57	0	1	NPO	0	1	Dobrý anjel	Ako dosiahnuť výsledky televíznej kampane čisto na sociálnych sieťach?	1	0	0	0	0	1
58	0	1	NPO	0	1	Liga za duševné zdravie	Vyliečme nezáujem	1	1	0	0	0	1

59	0	1	NPO	0	1	Únia nevidiacich a slabozrakých Slovenska	Život je krajší, keď sa v ňom máte o koho oprieť	1	0	0	0	1	1
60	0	1	Online service	0	1	Niké	Tipérsky kemp: ako vyhrať MS v hokeji	1	0	0	0	0	0
61	0	1	Others	0	1	Železničná spoločnosť Slovensko	Hlavu hore, ideme vlakom	1	0	0	0	0	0
62	0	1	Others	0	1	Polus	Polus: Prezlečte niekoho život k lepšiemu	1	0	0	0	1	1
63	0	1	Others	0	1	Slovenská aliancia moderného obchodu	Nechceme to zaplatiť	1	0	0	0	0	0
64	0	1	Online service	0	1	Bistro.sk	Raz-dva-tri, štyri	1	0	1	0	0	0
65	0	1	Others	0	1	Innogy	Slovenské more	1					0
66	0	1	NPO	0	1	Liga proti rakovine SR	Na koho myslíš, keď si pripínaš narcis?	1	0	0	0	1	1
67	0	1	NPO	0	1	Depaul Slovensko	Adoptuj si posteľ	1	0	0	0	0	1
68	0	1	NPO	0	1	Broz	Privítajte s nami migrantov!	1	0	0	0	0	1
69	0	1	Automotive	1	1	Hyundai Motor Czech s.r.o.	Hyundai so ženami, proti predsudkom.	1	0	0	0	0	1
70	0	1	Fast food	0	1	AmRest	#prepacmekac	1	0	0	0	1	0
71	0	1	Telecommunication	0	1	Slovak Telekom, a.s.	Zelená Magio pláž	1	0	0	0	1	1
72	0	1	Banking	0	1	Slovenská sporiteľňa	Pohoda BEZ	1	0	0	0	1	0
73	0	1	Telecommunication	0	1	Orange Slovensko, a.s.	Prekonanie navýšených cieľov pre predaj hlasových paušálov cez e-shop v druhom polroku 2018	1	0	0	0	0	0
74	0	1	Telecommunication	0	1	O2 Slovakia	Nebud' pirát	1	0	0	0	0	1
75	0	1	FMCG	0	1	Absolut - Pernod Ricard Slovakia	Slovensko žije všetkými farbami	1	0	0	0	1	1

#### 4.1 Evaluation of quantitative research with qualitative elements

Regarding the business field, the highest percentage (26%) of all the campaigns takes place in the fast-moving consumer goods area (FMCG), which in absolute value corresponds to 19 of them. The second highest percentage (20%) in the total of 14 campaigns belongs to the banking sector, followed by areas such as telecommunications (11%), NPO (10%), cosmetics (6%), online service (6%) and other (6%). The remaining business fields include areas such as fast food, automotive, electronics, household, finance and furniture as shown in Fig. 1.

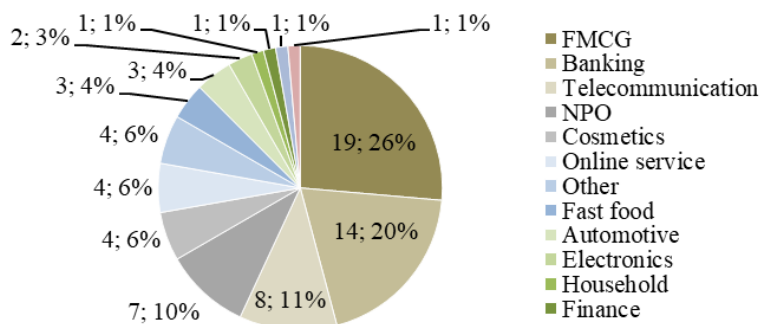

Fig. 1 – Contests' campaigns regarding the business field. Source: FLEMA (2019), EFFIE (2019)

As mentioned above, the FLEMA and EFFIE contests involve campaigns from across the Czech and the Slovak Republic. Of the total number of 71 evaluated campaigns, 17 of them represent the Czech Republic (24%), 45 of them come from Slovakia (63%) and the remaining 13%, i.e. 9 campaigns fall under both the Czech Republic and the Slovak Republic (Fig. 2).

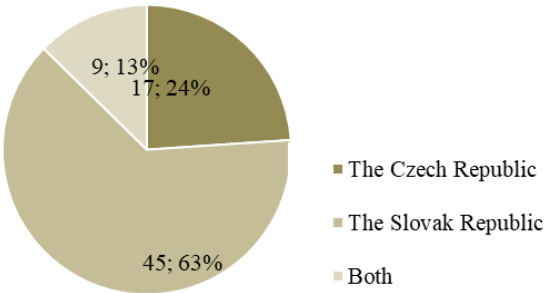

Fig. 2 – Geographical overview of campaigns. Source: FLEMA (2019), EFFIE (2019)

The following two figures (Fig. 3 and Fig. 4) show visually the ratio of individual campaigns regarding the social responsibility. Of all the 71 campaigns, only 30% of them carry such a message, which in absolute value corresponds to number 21. In terms of geographical representation 2 socially responsible campaigns of the 17 total campaigns participating in the contests are from the Czech Republic, 18 socially responsible campaigns from the total of 45 campaigns are from the Slovak Republic and 1 socially responsible campaign from the total of 9 campaigns was executed in both countries.

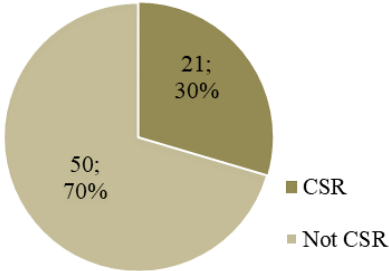

Fig. 3 – Overview of CSR and not CSR campaigns. Source: FLEMA (2019), EFFIE (2019)

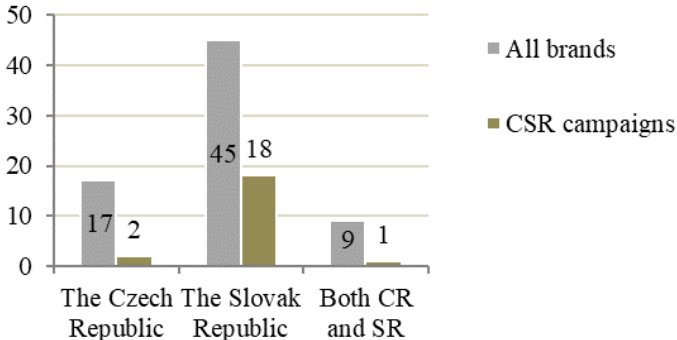

Fig. 4 – Campaigns regarding the geographical representation. Source: FLEMA (2019), EFFIE (2019)

Taking a closer look on the business field of the socially responsible campaigns, 4 of them were from FMCG area (1 executed on the Czech market and 3 on the Slovak market), seven of CSR campaigns were from NPO area (1 on the Czech market, 6 on the Slovak market), 3 of them from Telecommunications area (all of them executed on the Slovak market), 3 of them from the Banking area (all of them executed on the Slovak market) and the rest of CSR campaigns were from Automotive, Electronics and Other areas (Fig. 5).



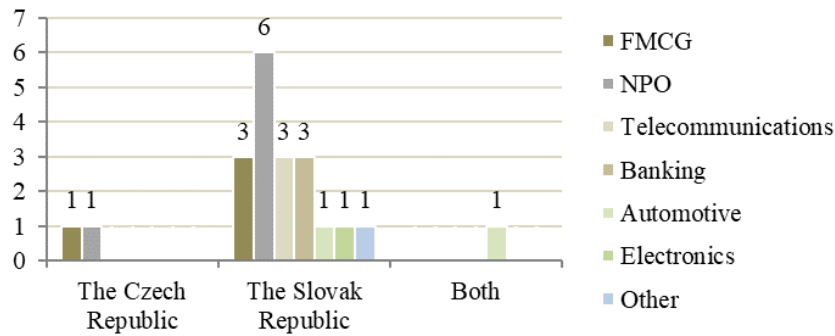

Fig. 5 – Campaigns regarding the business field. Source: FLEMA (2019), EFFIE (2019)

As stated in the chapter 2.1 of this paper, five crucial media channels, which are being used in marketing communication strategies of firms, have been identified – internet, TV, radio, print, and OOH. The following figure (Fig. 6) shows the number of FLEMA’s and EFFIE’s CSR campaigns distributed through the different above mentioned media types.

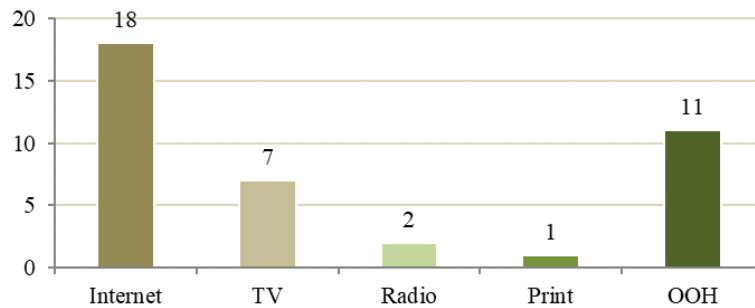

Fig. 6 – CSR occurrence in campaigns based on the media types. Source: FLEMA (2019), EFFIE (2019)

The collected and the evaluated data uncovered a situation in CSR approaches in the Czech and the Slovak advertisement and media market. CSR activities can serve as a strong factor in brand building, creating relationship with potential customer, securing retention of existing customers etc. Additionally, long term CSR activities are an effective source of financial vitality of a firm. Thus, it is important to (at least) carry in mind that CSR should in some way support traditional advertisement approaches of a firm.

#### 4.2 Hypotheses verification

To test the defined hypotheses, thus to determine whether there is a significant correlation between the contest type / country and the CSR occurrence, a Pearson’s Chi-square test of independence was conducted. To evaluate the strength of the association between the two variables, the effect size of Phi and Cramer’s V was used. The statistical analyses were conducted via IBM SPSS Statistics software and the results of the tests are shown in the following tables (Table 2 – Table 5).

Tab. 2 – Test of independence between the contest type and CSR occurrence. Source: own research

	Value	df	Asymp. Sig. (2-sided)	Exact Sig. (2-sided)	Exact Sig. (1-sided)
Pearson Chi-Square	<b>10,582<sup>a</sup></b>	1	<b>,001</b>		
Continuity Correction <sup>b</sup>	8,954	1	,003		
Likelihood Ratio	10,918	1	,001		
Fisher's Exact Test				,002	,001
N of Valid Cases	71				

The chi square statistic appears in the “Value” column of the above table (Table 2) immediately to the right of “Pearson Chi-Square”. As we can see from the results, the value of the chi-square statistic counts for 10,582. At the standard significance level  $\alpha = 5\%$ , and the degrees of freedom  $df = 1$ , the critical value of the chi-square distribution is 3,841. The result is significant if this value is equal to or less than 10,582. In this case,  $3,841 < 10,582$ , thus we reject the first null hypothesis and support the first alternative one which states that there is a significant association between the contest type and the CSR occurrence. The results can also be interpreted by the “Asymptotic Significance (2-sided)” column. We can see that the probability value (p-value) counts for 0,001. The result is significant if this value is equal to or less than the designated alpha level (0,050). In this case,  $0,001 < 0,050$ , therefore the first H1 is supported.

Tab. 3 – The effect size of Phi and Cramer’s V on the chi-square statistic. Source: own research

	Value	Approx. Sig.
Nominal by Nominal Phi	<b>,386</b>	,001
Cramer's V	<b>,386</b>	,001
N of Valid Cases	71	

To evaluate the strength of the above tested association, we used the effect size of Phi and Cramer’s V. The results can be interpreted by the “Phi” and the “Cramer’s” rows in the “Value” column (Table 3). For the table above (Table 3) this value equals 0,386. According to de Vaus (2002), the resulted value 0,386 indicates approximately a moderate to a relatively strong association. This means that the contest type has a moderate to relatively strong effect on CSR occurrence.

The following two tables (Table 4 and Table 5) show the results of the Pearson’s Chi-square test of independence between the country and the CSR occurrence (Table 4), as well as the effect size of Phi and Cramer’s V on the chi-square statistic (Table 5).

Tab. 4 – Test of independence between the country and CSR occurrence. Source: own research

	Value	df	Asymp. Sig. (2-sided)
Pearson Chi-Square	<b>6,410<sup>a</sup></b>	2	<b>,041</b>
Likelihood Ratio	7,063	2	,029
N of Valid Cases	71		

Based on the results above (Table 4), we can see that the value of the chi-square statistic counts for 6,410. At the standard significance level  $\alpha = 5\%$  and the degrees of freedom  $df = 2$ , the critical value of the chi-square distribution is 5,991. The result is significant if this value is equal to or less than 6,410. In this case,  $5,991 < 6,410$ , thus we reject the second null hypothesis and support the second alternative one which states that there is a significant association between the country and the CSR occurrence. The results can also be interpreted by the “Asymptotic Significance (2-sided)” column. We can see that the p-value counts for 0,041. The result is significant if this value is equal to or less than the designated alpha level (0,050). In this case,  $0,041 < 0,050$  therefore the second H1 is supported.

Tab. 5 – The effect size of Phi and Cramer’s V on the chi-square statistic. Source: own research

	Value	Approx. Sig.
Nominal by Nominal Phi	<b>,300</b>	,041
Cramer's V	<b>,300</b>	,041
N of Valid Cases	71	

The results of the effect size of Phi and Cramer's V on the chi-square statistic are again interpreted by the "Phi" and the "Cramer's V" rows in the "Value" column (Table 5). For the table above (Table 5) this value equals 0,300. According to de Vaus (2002) the resulted value 0,300 indicates approximately a moderate to a relatively strong association. This means that the country has a moderate to relatively strong effect on CSR occurrence.

## 5 CONCLUSION AND DISCUSSION

CSR and socially responsible activities are important source of competitive advantage. It can strengthen a position of a firm on overcrowded markets, bring additional customers and create strong bond with customer. It is important for a firm to step out of a comfort advertisement zone and create a CSR strategy, which is reflected in executed advertisement. CSR activities often demand brave idea, which can polarize a society. CSR activities can sometimes cut off some of the existing customers with opposite opinion on a situation, especially in advertisement working with race, environmental and food issues. On the other hand, such an advertisement can even more strengthen relationship with customers with the same opinion and lure new customers with the same point of view on the issue.

The conducted research worked with 71 advertisements executed by various brands. The original number of campaigns was 75, however because of duplication in both contests we removed the duplicated ones. Advertisements and brands were categorized into 14 business fields, and advertisements took place in all of media types. Researched advertisements might be considered as sample applicable on the whole market, because researched advertisements were signed into the biggest contests, which are considered as media and advertisement overview of the Czech and the Slovak market.

The findings of the research uncovered, that only 21 of all the researched advertisements were in some way socially responsible. That means, only 30% of advertisements on the Czech and the Slovak market have a socially responsible character. Theoretical research showed significant potential of CSR activities for firm. It can have a positive financial impact on a firm, build relationship with customer, strengthen position of a brand on a market, lure new customers etc. Due to researched numbers the utilization of CSR activities is insufficient, the topic is attractive for customers and there is a potential, that firm with socially responsible brand building will now succeed on a market because of low competition and high attractiveness in consumers' minds.

The verification of the first hypotheses confirmed that the contest type has a moderate to relatively strong effect on CSR occurrence. Thus, next research should consider to spread a contest list or to utilize a sample from mass market. For example analyse TV, radio, print, OOH or internet advertisements by same methods as this research utilizes.

Rejection of the second null hypothesis and support of the second alternative one which states that there is a significant association between the country and the CSR occurrence can also lead to further research, which might spread the sample as mentioned above and compare whether there is a correlation between the CSR, market and/or target group perception of CSR activities.

The biggest added value of the paper for commercial segment is recommendation to integrate CSR activities into advertisement activities as soon as possible. Due to attractiveness of this advertisement area it is (according to the opinion of the authors) just matter of time when CSR will be very spread and frequent advertisement approach and firms with delayed integration can later loose a market position.

Additionally, the authors of the paper expect, that advertisements with a socially responsible character have great chances to win the contest in individual categories. Such observation would

even strengthen recommendation for firms to utilize CSR activities more often. Further research could apply utilized research method on more commercial advertisements. Observation of television, print, radio, OOH and internet advertisements could spread a sample and confirm, refute or specify results of this paper. Further research could also research correlation between media type and CSR element in advertisements.

## Acknowledgment

This paper originated as the result of working on the grant scheme KEGA 016EU-4/2019 Innovative learning texts from marketing for secondary schools.

## References

- Abratt, R., & Sacks, D. (1988). The marketing challenge: Towards being profitable and socially responsible. *Journal of Business Ethics*, 7(7), 497-507. doi: 10.1007/BF00382596
- Aggarwal, S., Aggarwal, R., & Jha, P. C. (2014). Optimal Advertisement Planning for Multi Products Incorporating Segment Specific and Spectrum Effect of Different Medias. In B. Babu et al. (Eds.), *Proceedings of the Second International Conference on Soft Computing for Problem Solving (SocProS 2012)*. New Delhi: Springer. doi: 10.1007/978-81-322-1602-5\_140
- Aguinis, H., Edwards, J. R., & Bradley, K. J. (2017). Improving Our Understanding of Moderation and Mediation in Strategic Management Research. *Organizational Research Methods*, 20(4), 665-685. doi: 10.1177/1094428115627498
- Alday, J., Murukutla, N., Cedillo, C., Johns, P., Monteiro, A., & Wakefield, M. (2010). Smoke-free Sao Paulo: a campaign evaluation and the case for sustained mass media investment. *Salud Pública de México*, 52(2), S216-S225. doi: 10.1590/S0036-36342010000800017
- Atuahene-Gima, K. (1995). An exploratory analysis of the impact of market orientation on new product performance a contingency approach. *Journal of Product Innovation Management*, 12(4), 275-293. doi: 10.1016/0737-6782(95)00027-Q
- Beverland, M. B., Napoli, J., & Farrelly, F. (2010). Can All Brands Innovate in the Same Way? A Typology of Brand Position and Innovation Effort. *Journal of Product Innovation Management*, 27(1), 33-48. doi: 10.1111/j.1540-5885.2009.00698.x
- Boccia, F., Malgeri Manzo, R., & Covino, D. (2019). Consumer behavior and corporate social responsibility: An evaluation by a choice experiment. *Corporate Social Responsibility and Environmental Management*, 26(1), 97-105. doi: 10.1002/csr.1661
- Cambra-Fierro, J. J., Hart, S., Fuster Mur, A., & Polo Redondo, Y. (2011). Looking for performance: How innovation and strategy may affect market orientation models. *Innovation*, 13(2), 154-172. doi: 10.5172/impp.2011.13.2.154
- Carpenter, J. M., Moore, M., & Fairhurst, A. E. (2005). Consumer shopping value for retail brands. *Journal of Fashion Marketing and Management: An International Journal*, 9(1), 43-53. doi: 10.1108/13612020510586398
- Castaldo, S., Perrini, F., Misani, N., & Tencati, A. (2009). The Missing Link between Corporate Social Responsibility and Consumer Trust: The Case of Fair Trade Products. *Journal of Business Ethics*, 84(1), 1-15. doi: 10.1007/s10551-008-9669-4

- Copuš, L., Papík, M., & Olšavský, F. (2017). *Corporate Social Responsibility and Societal Marketing Concept in Financial Sector*. Paper presented at the 29th International Business Information Management Association Conference, Vienna. Retrieved from [www.academia.edu/34183234/Corporate\\_Social\\_Responsibility\\_and\\_Societal\\_Marketing\\_Concept\\_in\\_Financial\\_Sector\\_Slovak\\_Perspective\\_](http://www.academia.edu/34183234/Corporate_Social_Responsibility_and_Societal_Marketing_Concept_in_Financial_Sector_Slovak_Perspective_)
- Corstjens, M., & Lal, R. (2000). Building Store Loyalty through Store Brands. *Journal of Marketing Research*, 37(3), 281-291. doi: 10.1509/jmkr.37.3.281.18781
- Edell, J. A., & Keller, K. L. (1989). The Information-Processing of Coordinated Media Campaigns. *Journal of Marketing Research*, 26(2), 149-163. doi: 10.2307/3172602
- EFFIE (2019). *EFFIE Awards Czech Republic 2019*. Retrieved from <https://effie.cz/>
- EMarketer. (2018). *eMarketer Releases New Global Media Ad Spending Estimates*. Retrieved from <https://www.emarketer.com/content/emarketer-total-media-ad-spending-worldwide-will-rise-7-4-in-2018>
- FLEMA (2019). *FLEMA Media Awards 2019*. Retrieved from <https://awards.flema.cz/>
- Goos, P., Dens, N., De Pelsmacker, P., & Aleksandrovs, L. (2019). Using mixture-amount modeling to optimize the advertising media mix and quantify cross-media synergy for specific target groups. *Applied Stochastic Models in Business and Industry*, 35(5), 1228-1252. doi: 10.1002/asmb.2470
- Ha-Brookshire, J. E., & Hodges, N. N. (2009). Socially Responsible Consumer Behavior? *Clothing and Textiles Research Journal*, 27(3), 179-196. doi: 10.1177/0887302X08327199
- Hur, W. M., Moon, T. W., & Ko, S. H. (2018). How Employees' Perceptions of CSR Increase Employee Creativity: Mediating Mechanisms of Compassion at Work and Intrinsic Motivation. *Journal of Business Ethics*, 153(3), 629-644. doi: 10.1007/s10551-016-3321-5
- Kotler, P. (2007). *Moderní marketing*. Praha: Grada.
- Krohn, S. (2018). *Four Types of Corporate Social Responsibility*. Retrieved from <https://bizfluent.com/info-8459857-functions-corporate-social-responsibility.html>
- Loussaïef, L., Cacho-Elizondo, S., Pettersen, I. B., & Tobiassen, A. E. (2014). Do CSR actions in retailing really matter for young consumers? A study in France and Norway. *Journal of Retailing and Consumer Services*, 21(1), 9-17. doi: 10.1016/j.jretconser.2013.09.005
- Neijens, P., & Voorveld, H. (2015). Cross-Platform Advertising: Current Practices and Issues for the Future. *Journal of Advertising Research*, 55(4), 362-367. doi: 10.2501/JAR-2015-016
- Rahman, M., Rodríguez-Serrano, M. Á., & Lambkin, M. (2017). Corporate Social Responsibility and Marketing Performance. *Journal of Advertising Research*, 57(4), 368-378. doi: 10.2501/JAR-2017-047
- Rodríguez, I., Rubio, F., & Rabanal, P. (2016). *Automatic media planning: optimal advertisement placement problems*. Paper presented at 2016 IEEE Congress on Evolutionary Computation, Vancouver, Canada. Vancouver: IEEE. doi: 10.1109/CEC.2016.7748345
- Saha, A. (2016). *Use of Corporate Social Responsibility for the Sustainable Development of Organization*. Paper presented at 12th Annual International Bata Conference, Zlín, Czech Republic. Zlín: Tomas Bata University in Zlín. doi: 10.7441/dokbat.2016.35

Snyder, J., & Garcia-Garcia, M. (2016). Advertising across Platforms: Conditions for Multimedia Campaigns A Method for Determining Optimal Media Investment and Creative Strategies across Platforms. *Journal of Advertising Research*, 56(4), 352-367. doi: 10.2501/JAR-2016-042

Vilčeková, L. (2016). Advertising Credibility across Different Media Channels. *International E-Journal of Advances in Social Sciences*, 2(4), 126-129. doi: 10.18769/ijasos.38812

### **Contact information**

#### **Ing. Martin Kuchta, PhD.**

University of Economics in Bratislava, Faculty of Commerce  
Dolnozemska cesta 1, 85235, Bratislava, Slovak Republic  
E-mail: martin.kuchta@euba.sk  
ORCID: 0000-0001-5546-7773

#### **Ing. Monika Stanková**

University of Economics in Bratislava, Faculty of Commerce  
Dolnozemska cesta 1, 85235, Bratislava, Slovak Republic  
E-mail: monika.stankova@euba.sk  
ORCID: 0000-0002-3992-6869

#### **Ing. Maria Hasprova, PhD.**

University of Economics in Bratislava, Faculty of Commerce  
Dolnozemska cesta 1, 85235, Bratislava, Slovak Republic  
E-mail: maria.hasprova@euba.sk  
ORCID: 0000-0003-1726-8719

doi: 10.7441/dokbat.2019.060

# THE ROLE OF SOCIAL MEDIA USAGE IN THE EFFECTIVENESS OF MANAGERS FROM FOOD COMPANIES

*Silvia Lenčėšová, Mária Šajbidorová, Zuzana Lušňáková, Boris Rumanko*

## Abstract

We live in a digitalized, globalized world where people can communicate without physical contact. Social media connect different people from different parts of the world. The aim of the scientific paper is to find out the effect of the social media on the effectiveness at workplace. The research was realized through the questionnaire which consisted of 12 questions divided into 3 parts. First part were identification factors (such as gender, age, position in the firm and length of time in the company). Second part were questions with different choice of answers and third part were questions with 5-degree Likert scale, where the respondents expressed the degree of their agreement or disagreement with the particular statement. The respondent can answer individual statements using a five-point scale where 1 represents "definitely disagree" and 5 presents "definitely agree". The research was realized from September 2018 to April 2019. 247 respondents participated in our research. They were business managers from food companies, which operate in the Slovak Republic in Nitra region. Data processing was performed using statistical program SAS Enterprise Guide 7.1 and the statistical relations between variables were performed using Kruskal-Wallis test. We can summarize, that it is not possible to clearly determine the positive or negative impact of using social modes while working on the effectiveness of managers, because many factors affect their efficiency. Social (despite their benefits) media poses a threat to managers if they become a time-thief.

*Keywords: social media, effectiveness, productivity, workplace*

## 1 INTRODUCTION

At present, social media use is considered to be a normal part of life, regardless of whether it is a normal life or a working life. We live in a digitalized, globalized world where people communicate without physical contact. Social media uses the Internet to connect different people from different parts of the world. Facebook, Instagram, Messenger, Viber, WhatsApp, YouTube, and many other platforms help people around the world communicate and interact. The aim of the scientific paper is to find out the effect of the social media on the effectiveness at workplace.

## 2 THEORETICAL BACKGROUND

Social media is an internet application that allows the creation and exchange of user-created content (Kaplan & Haenlein, 2010). Social media is a web-based platform that allows individuals to share, post, edit, organize, and store different types of news, information and knowledge (text, images, videos, documents, etc.) with other individuals. Social media is collaborative and flexible, agile, spontaneous, unstructured and informal (McAfee, 2006). According to Kaplan and Haenlein (2010), there are six different types of social media: collaborative projects (e.g. Wikipedia), blogs and microblogs (e.g. Twitter), content communities (e.g. Youtube), social networking sites (e.g. Facebook), virtual game worlds (e.g. World of Warcraft) and virtual social worlds (e.g. Second Life).

Companies see social media as beneficial in branding, reaching new customers, gathering information about purchasing behaviour and building reputation or credibility with overall positive effects on the company's financial performance (Berthon et al., 2012; Paniagua & Sapena, 2014). Social media can be beneficial to facilitate the work of employees. Social media offers the opportunity to strengthen networks between employees in a company, the ability to build friendships, share information needed to perform tasks, access resources and get support or advice (Liu et al, 2015).

Some people perceive social media as a private tool used for leisure and do not want it to interfere with their work, while others use social media as a tool to facilitate work activities and facilitate work interactions. The more people use social media for leisure, the more they prefer to maintain high privacy (McDonald & Thompson, 2016). People who use social media to work in their organization can develop more professionally oriented social media profiles with information about their employment history - to make them more attractive to recruiters in human resources (Bizzi, 2018). In fact, employees should be sensitive to the disclosure of private information and the risk of reputational damage. Because based on the results of a research study, we can say that employees post information on social networks about their co-workers, jobs and customers. Some of these comments, especially those related to customers, were negative. In order to avoid possible legal problems, employers should educate their employees on social media policies early and often. Working life and online life are interrelated and organizations need to develop and communicate policies to help workers understand what behaviour is appropriate (O'Connor et al., 2016).

The positive effect of using social media at work is the effective communication, availability and fulfilment of psychological needs, which in fact contribute to the feeling of employee engagement (Zoonen, Verhoeven, & Vliegthart, 2017). Social media has brought businesses new management practices, from creating innovative business models to transforming communication, collaboration and knowledge sharing. Social media applications in the work environment can increase individual performance and productivity (Cao & Yu, 2019).

Productivity refers to the time an employee actively performs in the job in which he / she was employed to achieve the desired results expected from the employee's job description (Ferreira & Plessis, 2009). Work performance is associated with employees' ability to know the assigned goals, meet expectations and achieve goals, or fulfil a standard set of tasks for an organization. Work performance is directly related to employee efficiency (June & Mahmood, 2011).

Given the popularity of social media, social media platforms have been adopted by organizations also for work purposes (Liu & Bakici, 2019). But frequent usage of social media can have an influence on worker productivity. Employees may waste valuable time using Social Media Networking (Baruah, 2012). The social media sites could be wasting managers' time, addictive and full of misinformation. But following some basic rules for engagement and avoiding spending too much time on them, social media sites could be used productively and in a smart way (Malita, 2011). Given the popularity of social media, social media platforms have been adopted by organizations also for work purposes. Excessive use of public social media leads to distractions at work, negatively affecting the performance of employees in the working environment (Moqbel & Kock, 2017) or employee performance (Leftheriotis & Giannakos, 2014).

In general, social media stimulates collaboration and knowledge sharing among individuals, which can lead to increased or decreased productivity. However, social media should be used effectively in order to get the best results from employees, because there are pitfalls that employees could succumb to if left unattended. (Aguenza, Al-Kassem, & Som, 2012)



With an increasing trend in social media and a busy business environment, organizations and employees must be able to keep up with this trend and use social media in their daily work to avoid being left behind and plunging into a competitive environment. The use of social media is therefore a key contributor for employees and organizations to achieve maximum performance levels for competitive advantage. (Radhakrishnan, Basit, & Hassan, 2018)

The use of social media by companies and individuals has become a fundamental trend of business activities (companies) and entertainment/socialization (individuals). Most employees expect that social media focusing on work and socialization can coexist in the workplace. Sharing work-oriented and socialization-oriented social media is of greater value, as socialization, facilitated by social media, is becoming a routine and a necessity in the work of employees and complements and smoothly performs instrumental activities at work. This suggests that social media for work and socialization are complementary and create synergies in the workplace. (Song et al, 2019)

### **3 METHODOLOGY**

The research was realized through the questionnaire which consisted of 12 questions divided into 3 parts. First part were identification factors (such as gender, age, position in the firm and length of time in the company). Second part were questions with different choice of answers and third part were questions with 5-degree Likert scale, where the respondents expressed the degree of their agreement or disagreement with the particular statement. The respondent can answer individual statements using a five-point scale where 1 represents "definitely disagree" and 5 presents "definitely agree".

The research was realized from September 2018 to April 2019. 247 respondents participated in our research. They were business managers from food companies, which operates in the Slovak Republic in Nitra region. Data processing was performed using statistical program SAS Enterprise Guide 7.1. The statistical relations between variables were performed using Kruskal-Wallis test. The Kruskal-Wallis test represents a nonparametric form of single-factor analysis of variance to compare two or more independent samples. This test can be used to investigate the significance of differences in the mean values of independent files (Markechová, Stehlíková & Tirpáková, 2011).

The target group of respondents were managers operating at different levels of management of Slovak food enterprises in Nitra region. In total 247 respondents participated in our research. 110 respondents were men (44.5%) and 137 respondents were women (55.5%). The largest group of managers were 26-35 years old, the second largest group were 36-45 years. They were followed by managers aged 46-55, up to 25, 55-65, and the smallest representation in the research sample had managers over 65 years. 42.1% of managers were at the lowest managerial level. 32% were middle management and 25.9% top management. The structure of the research sample of managers according to the duration of their activity in the company is as follows. Most respondents (32.1%) work in the company for 2 to 3 years. 25.1% of the participating managers are 11 and more years in the business, 19% of the respondents are from 6 to 10 years in the company, 15% are 4 to 5 years in the company and the least (8.8%) of the respondents are in the company for less than 1 year.

### **4 RESULTS AND DISCUSSION**

We found out that the most used social media during work is Messenger (60%), Facebook (53.8%) and Instagram (40.1%). Viber uses 30% of respondents, WhatsApp 26% and YouTube 15%. Alwagait, Shahzad and Alim realized research in 2014 in Saudi Arabia with 108

respondents. The most popular social media was Twitter, on the second place was Facebook, and on the third place was Instagram (Alwagait, Shahzad & Alim, 2015). Facebook, along with other social media platforms, has penetrated the traditional workplace. It's not uncommon for co-workers to be friends on Facebook, although some people are cautious about doing this (Hanna, Kee & Robertson, 2016).

The biggest part of managers participated in our research (41.7%) spend from 1 to 2 hours using social media during work. 38.1% of managers spend more than 2 hours using social media during work and 20.2% of managers spend less than hour using social media during work.

The frequency of using different social media during work has impact on the managers' effectiveness at the workplace. 4.1% of managers participated in our research rarely use social media during work. Regarding to the fact that using social media during work is considered like time-thief, then 4.1% is very low share. 15.8% of managers use social media from 1 to 3 times per day, 23.5% of managers use it from 4 to 6 per day and 16.6% of managers use social media from 7 to 9 times per day during work. The biggest part (40%) use social media during work more than 10 times per day, what can be considered like alarming and definitely like time-thief.

Cao and Yu realized research in China in 2019 with 305 respondents. Their respondents answered on average daily frequency of social media usage at work as follow: rarely (3.6%), 1-3 times per day (16.7%), 4-6 times per day (21.3%), 7-9 times per day (13.1%), more than 10 times per day (45.2%). If we compare the results, we can see that we have reached similar findings (Cao & Yu, 2019). We can summarize that using social media during work is unambiguously considered to be time-thief for the managers.

However, social media doesn't has to be considered only like time-thief, but can be used also for working purposes. The mangers can through social media look for new customers or new employees, or to use social media to promote the company and so on. Only 2.8% of managers use every time social media for working purposes, 13% uses it often, 24.7% sometimes, 30% rarely and 29.5% of managers do not use social media for working purposes.

Leftheriotis and Giannakos (2014) made research in Greece in 2012 with 1799 respondents. They found out, that 7% of asked employees every time use social media for working purposes, 12% often, 21% sometimes, 27% rarely and 33% not at all. We reached very similar findings.

Like the next, we were interested in the motivation of managers to use social media during work. If they use it to enjoy free time (which is questionable because they are at work) or they use it for some working purpose. For the most managers (32%) is enjoying their free time the biggest motivation to use social media during work. 27.1% choose keep contact with customers, 24.3% find new customers, 10.1% recruit personnel and 6.5% watch market/competitors. Siegel states that companies largely use social media for recruiting. The study evaluated 100,000 employee responses with 33,000 respondents active on 1-4 social networks. In particular, 65% of small companies, 51% of medium sized companies and 44% of large companies use social media for recruiting. Over 80% of employers who use social media for recruiting use LinkedIn (Siegel, 2014).

In our research, respondents have to choose 1 answer. Leftheriotis and Giannakos (2014) also verified employees' motivations for using social media for their work, but they use 5-degree scale to determine level of agreement or disagreement with individual options of motivation to use social media during work. 57.8% of the employees claim that, at least at moderate level, they have used social media in order to watch the market/competitors. Keeping contact with customers follows with 51%. Enjoying free time comes third with 44.4% and then finding new customers with 42.7%. Recruiting personnel comes last with 54.5% of employees claiming that they are not using social media at all for this reason.

Baruah (2012) realized research in India with 200 respondents. On being asked the major forms of social media tools which the respondents preferred the most, 25% respondents said that they prefer social networking the most, 16% respondents giving their preference for wikis, 13% respondents for video sharing, 12.5% respondents for microblogging, 11.5% respondents for blogs, 9% respondents for social news and bookmarking, 5% respondents for photo sharing, 4.5% respondents for podcasts and 3.5% respondents have preferred RSS (Really Simple Syndication) as a potent social media tool.

We have realized Kruskal-Wallis test to examine differences between answers from questionnaire and respondents' gender, age, position in the firm and length of time in company. Results are shown in Tables 1, 2 and 3. Value marked with "\*\*\*" means that there is highly statistical significant difference on the level of significance 99% (Alpha = 0.01). And values marked with "\*\*" means that there is statistical significant difference on the level of significance 95% (Alpha = 0.05).

Tab. 1 – Kruskal-Wallis test: Time spent using social media during working hours is lost. Source: own research

Identification factor	Values of Kruskal-Wallis test
Gender	0.9787
Age	0.0300*
Position in the firm	0.7608
Length of time in company	0.4059

Based on Kuskal-Wallis test, we can say, that there are statistically significant differences in considering the time spent using social media during working hours as lost between individual managers in terms of their age on the level of significance 95%. Values of Kruskal-Wallis test are in the Table 1. We can say, that managers age has impact on considering the time spent using social media as lost and at the same time gender, position in the firm and length of time in company do not affects considering the time spent using social media during working hours.

Tab. 2 – Kruskal-Wallis test: Communication between me and my colleagues is efficient. Source: own research

Identification factor	Values of Kruskal-Wallis test
Gender	0.0120*
Age	0.0085**
Position in the firm	0.4854
Length of time in company	0.0412*

Subsequently we were interested in respondents' opinion on the statement: The communication (by using social media) between me and my colleagues is efficient. Values of Kruskal-Wallis test are shown in the Table 2. There we can see that biggest differences in opinions were between managers by age. There are highly statistical significant differences in considering the communication (by using social media) with colleagues like efficient in terms of their age on the level of significance 99%. However there are also statistical significant differences in considering the communication (by using social media) with colleagues like efficient in terms of gender and length of time in company on the level of significance 95%. We can summarize, that position in the firm (based on our research) do not affects consideration of communication with colleagues like efficient.

Tab. 3 – Using social media during work has a negative impact on my effectiveness. Source: own research

Identification factor	Values of Kruskal-Wallis test
Gender	0.3304
Age	0.8612
Position in the firm	0.0373*
Length of time in company	0.9998

Like the last but not least we were interested in respondents' opinion about using social media during working hours has a negative impact on their effectiveness at work. The respondent's role was to express his or her level of agreement respectively disagreement. Results of Kruskal-Wallis test are shown in the Table 3, where we can see that there are statistical significant differences in negative impact on managers' effectiveness at work because of using social media during working hours between managers in terms of their position in the firm on the level of significance 95%. There are no differences in opinions between managers by their gender, age or length of time in the company.

Cetinkaya and Rashid (2019) examined the relationship between the use of social media and the performance of the work of an employee with the mediating role of an organizational structure. Their results indicated that there is a positive relationship between social media use and work performance. In addition, the organizational structure has an intermediary role between the two variables.

## **5 CONCLUSIONS**

It is not possible to clearly determine the positive or negative impact of using social media while working on the effectiveness of managers, because many factors affect their efficiency. Based on the results of our research our conclusions are: (1) The most used social media during work are Messenger, Facebook and Instagram; (2) The biggest part of managers participated in our research spend from 1 to 2 hours using social media during work and they use it more than 10 times per day; (3) The most managers use rarely social media for working purposes and if they use it, it is for the purpose of keeping contact with customers. But for the most managers is enjoying their free time the biggest motivation to use social media during work; (4) There are statistically significant differences in considering the time spent using social media during working hours as lost between individual managers in terms of their age; (5) There are statistical significant differences in considering the communication (by using social media) with colleagues like efficient between managers in terms of their age, gender and length of time in the company; and (6) There are statistical significant differences in negative impact on managers' effectiveness at work because of using social media during working hours between managers in terms of their position in the firm.

We can summarize, that despite their benefits, social media poses a threat to managers if they become a thief of time. It is because most managers spend one to two hours on social media during working hours. This represents 12.5% to 25% of the standard 8-hour working time in Slovakia. Of course, if managers use social media for working purposes (like keeping contact with customers, finding new customers, recruiting personnel and so on), it is not a time-thief.

Limitation: The research sample consisted only of managers working at various levels of management in food businesses from the Nitra region of the Slovak Republic.

Future research: Further research could also be carried out in other regions of Slovakia and could also include all other employees of food businesses operating in Slovakia.

### **Acknowledgements**

This paper was created within the KEGA project Theory and practice of human resources management and managerial work. Project registration number 041SPU-4/2018.

## References

- Aguenza, B. B., Al-Kassem, A. H., & Som, A. P. M. (2012). Social Media and Productivity in the Workplace: Challenges and Constraints. *Interdisciplinary Journal of Research in Business*, 2(2), 22-26. doi: 10.1.1.306.6573
- Alwagait, E., Shahzad, B., & Alim, S. (2015). Impact of social media usage on students academic performance in Saudi Arabia. *Computers in Human Behavior*, 51, 1092-1097. doi: 10.1016/j.chb.2014.09.028
- Baruah, T. D. (2012). Effectiveness of Social Media as a tool of communication and its potential for technology enabled connections: A micro-level study. *International Journal of Scientific and Research Publications*, 2(5), 1-10. doi: 10.1.1.376.5533
- Berthon, P. R., Pitt, L. F., Plangger, K., & Shapiro, D. (2012). Marketing meets Web 2.0, social media, and creative consumers: Implications for international marketing strategy. *Business Horizons*, 55(3), 261-271. doi: 10.1016/j.bushor.2012.01.007
- Bizzi, L. (2018). The hidden problem of Facebook and social media at work: What if employees start searching for other jobs? *Business Horizons*, 61(1), 23-33. doi: 10.1016/j.bushor.2017.09.002
- Cao, X., & Yu, L. (2019). Exploring the influence of excessive social media use at work: A three-dimension usage perspective. *International Journal of Information Management*, 46, 83-92. doi: 10.1016/j.ijinfomgt.2018.11.019
- Cetinkaya, A. S., & Rashid, M. (2019) The Effect of Social Media on Employees' Job Performance: The mediating Role of Organizational Structure. *Journal of Organizational Psychology*, 18(4), 94-116. doi: 10.33423/jop.v18i4.88
- Ferreira, A., & Plessis, T., (2009). Effect of online social networking on employee productivity. *South African Journal of Information Management*, 11 (1), doi: 10.4102/sajim.v11i1.397
- Hanna, B., Kee, K. F., & Robertson, B. W. (2016). Positive impacts of social media at work: Job satisfaction, job calling, and Facebook use among co-workers. *SHS Web of Conferences*, 33. doi: 10.1051/shsconf/20173300012
- June, S., & Mahmood, R. (2011). The Relationship between Person-Job Fit and Job Performance: A Study among the Employees of the Service Sector SMEs in Malaysia. *International Journal of Business, Humanities and Technology*, 1(2), 95-105. doi: 10.1.1.461.1262
- Kaplan, A. M., & Haenlein, M. (2010). Users of the world, unite! The challenges and opportunities of social media. *Business Horizons*, 53(1), 59-68. doi: 10.1016/j.bushor.2009.09.003
- Leftheriotis, I., & Giannakos, M. N. (2014) Using social media for work: Losing your time or improving your work? *Computers in Human Behavior*, 31, 134-142. doi: 10.1016/j.chb.2013.10.016
- Liu, Y., & Bakici, T. (2019). Enterprise social media usage: The motives and the moderating role of public social media experience. *Computers in Human Behavior*, 101, 163-172. doi: 10.1016/j.chb.2019.07.029
- Liu, D., Brass, D., Lu, Y., & Chen, D. (2015). Friendships in online peer-to-peer lending: Pipes, prisms, and relational herding. *MIS Quarterly*, 39(3), 729-742. doi: 10.2139/ssrn.2251155

- Malita, L. (2011). Social media time management tools and tips. *Procedia Computer Science*, 3, 747-753. doi: 10.1016/j.procs.2010.12.123
- Markechová, D., Stehlíková, B., & Tirpáková, A. (2011). Štatistické metódy a ich aplikácie. Nitra: Univerzita Konštantína Filozofa.
- McAfee, A. (2006). Enterprise 2.0: The dawn of emergent collaboration. In T. L. Tuten (Ed.), *Enterprise 2.0: How Technology, Ecommerce, and Web 2.0 are Transforming Business Virtually*. Santa Barbara: ABC-CLIO.
- McDonald, P., & Thompson, P. (2016). Social media(tion) and the reshaping of public/private boundaries in employment relations. *International Journal of Management Reviews*, 18(1), 69-84. doi: 10.1111/ijmr.12061
- Moqbel, M., & Kock, N. (2017). Unveiling the dark side of social networking sites: Personal and work-related consequences of social networking site addiction. *Information & Management*, 55(1), 109-119, doi: 10.1016/j.im.2017.05.001
- O'Connor, K. W., Schmidt, G. B., & Drouin, M. (2016). Helping workers understand and follow social media policies. *Business Horizons*, 59(2), 205-211. doi: 10.1016/j.bushor.2015.11.005
- Paniagua, J., & Sapena, J. (2014). Business performance and social media: Love or hate? *Business Horizons*, 57(6), 719-728. doi: 10.1016/j.bushor.2014.07.005
- Radhakrishnan, G. S., Basit, A., & Hassan, Z. (2018). The Impact of Social Media Usage in Employee and Organization Performance: A Study on Social Media Tools Used by an IT Multinational in Malaysia. *Journal of Marketing and Consumer Behaviour in Emerging Markets*, 1(7), 48-65. doi: 10.7172/2449-6634.jmcbem.2018.1.3
- Siegel, B. (2014). *Social Media in the Workplace: Does it Impact productivity?* Schaumburg: Lake Forest Graduate School of Management. Retrieved from <https://www.lakeforestmba.edu/blog/social-media-workplace-impact-productivity/>
- Song, Q., Wang, Y., Chen, Y., Benitez, J., & Hu, J. (2019). Impact of the usage of social media in the workplace on team and employee performance. *Information & Management*, 56(8), 103160. doi: 10.1016/j.im.2019.04.003
- Zoonen, W., Verhoeven, J. W. M., & Vliegthart, R. (2017). Understanding the consequences of public social media use for work. *European Management Journal*, 35(5), 595-605. doi: 10.1016/j.emj.2017.07.006

## Contact information

### **Ing. Silvia Lenčesová**

Slovak University of Agriculture in Nitra, Faculty of Economics and Management  
Tr. A. Hlinku 2, 94976, Nitra, Slovak Republic  
E-mail: xlencesovas1@is.uniag.sk  
ORCID: 0000-0001-5826-3813

### **doc. Ing. Mária Šajbidorová, PhD.**

Slovak University of Agriculture in Nitra, Faculty of Economics and Management  
Tr. A. Hlinku 2, 94976, Nitra, Slovak Republic  
E-mail: maria.sajbidorova@uniag.sk  
ORCID: 0000-0002-7120-7653

**Ing. Zuzana Lušňáková, PhD.**

Slovak University of Agriculture in Nitra, Faculty of Economics and Management

Tr. A. Hlinku 2, 94976, Nitra, Slovak Republic

E-mail: zuzana.lusnakova@uniag.sk

ORCID: 0000-0001-6331-9930

**Ing. Boris Rumanko**

Slovak University of Agriculture in Nitra, Faculty of Economics and Management

Tr. A. Hlinku 2, 94976, Nitra, Slovak Republic

E-mail: xrumankob@uniag.sk

ORCID: 0000-0002-3320-8508

doi: 10.7441/dokbat.2019.061

# MEASUREMENT OF ECONOMIC VALUE OF BEE POLLINATION THROUGH BIOECONOMIC APPROACH IN CONDITIONS OF SLOVAK AND CZECH REPUBLIC

*Michal Levický*

## **Abstract**

The main benefit of beekeeping is not the production of honey and other bee products, but the pollination of cultural and wild crops that are dependent on bee pollination. In this paper we will deal with pollination, which can be considered as an ecosystem service. The aim of this paper is to estimate the value of pollination activity of bees in Slovakia and the Czech Republic in 2017. We will use the bioeconomic approach. This methodology focuses on the use value of pollination. Its essence is to estimate the impact of pollination on the variation in income of producers of crops that are dependent on pollination. The calculation was based on producer prices and yields of the main crops in the country, the source of which was the Faostat database. The mentioned data were supplemented by a coefficient of dependence on bee pollination. These data can be found in the work of agrobiologists. Based on the methodology used, we subsequently estimated the value of bee pollination. In the case of Slovakia it was € 96 272 261, in the Czech Republic € 164 630 322. Both countries have the advantage, that the number of bee colonies is relatively sufficient. Unfortunately, in many countries of the world, but also in the European Union, the loss due to bee shortage is also calculated.

*Keywords: environmental economics, pollination, bioeconomic approach, ecosystem services*

## **1 INTRODUCTION**

The beekeeping industry provides mankind with two forms of benefit. The direct benefit is the production of bee products such as honey, beeswax, bee venom, pollen and royal jelly. In terms of significance, however, the indirect benefit of bee-keeping is sunk. Bees pollinating provide crops and wild flowers. Therefore, the main task of bee colonies is pollination, the effect of which is many times higher than the value of the products of these insects (Madrás-Majewska & Majewski, 2016; Špyrka, 1989). Due to changes in production technologies, environmental pollution, intensive pesticide use, as well as climate change and the development of diseases and pests, bee populations are at risk worldwide. Based on FAO data, the number of bee colonies in Europe has increased by 30% in the past 50 years, but the crop area, which is somewhat dependent on pollination, has tripled, leading to losses due to reduced crop yields (Madrás-Majewska & Majewski, 2016). Slovakia and the Czech Republic are among the countries with a relatively good number of bees in the European Union.

## **2 THEORETICAL BACKGROUND**

### **2.1 Pollination as an ecosystem service**

Human society has the effect of many natural and ecological functions, called ecosystem functions. Such functions include pollination by insects that carry pollen within a single plant or among multiple flowers (Fisher, Turner & Morling, 2009). FAO (2006) considers pollination an important element in the functioning of ecosystems and in the production of a wide range of crops. The value of pollination activity is therefore derived from its contribution to the conservation of ecosystems and biodiversity, as well as from the impact on agriculture. The



positive effect of pollination activity of honey bees on increased hectare yields of seeds and fruits has been experimentally proved in a large number of research works over the last decades (Popovič, 2000). The pollination process is very markedly dependent on various external factors that have a meteorological, agrotechnical, vegetative, apicultural nature. Bees have a decisive role in the pollination process (Lampeitl, 1995). Diemerová (1997) considers the fidelity of a flower to be a rare property of bees. The flowers are not flown by bees without selection, randomly, but always fly to flowers of the same species, which means that they subsequently pollinate the right (same) plant. Lampeitl (1995) considers the fidelity of space to be another important feature of the bee, which means that the bee flies to plants in the same area as long as they provide a source of food for it. Carreck & Williams (1998) state that bees are generally considered to be the most important pollinators in nature. About 80% of the world's pollination of agricultural crops is provided by the European bee (*Apis mellifera*). An even greater significance of bees is reported in Allsopp - Lange - Veldtman (2008), which assigns it at least 90% of insect pollination. The fact that the insect is most suitable for pollinating a particular plant is determined primarily by the anatomical structure of the plant and insect. Under the conditions of the Slovak Republic, more than 80% of all plant species depend on insects. Table 1 shows the list of important crops in Europe where the number of fruits and their quality are significantly dependent on insect pollination. Klein et al. (2007) report that pollination brings benefits in the form of increased yields for up to 75% of globally important crop species. As a result of pollination, total world crop production increases by up to 35%. Quantification of the effect of pollination on the increase of crop yields was dealt with e.g. Hein (2009). According to his work, the following crops are most dependent on insect pollination: oilseed rape, sunflower, onion, melon, apple, cucumber, pumpkin, and mango.

Tab. 1 – Important European crops dependent on insect pollination.

Source: Corbet, Williams & Osborne (1991); Williams (1996)

<b>Fruits</b>	apple, orange, pear, tomato, peach, melon, strawberry, raspberry, plum, cherry, kiwi, mango, olive, grapes, apricot, currant
<b>Vegetables</b>	carrots, potatoes, onion, pumpkin, beans, eggplant, cucumber, soya
<b>Seeds and nuts</b>	sunflower, walnut, chestnut, almond
<b>Spices and medicinal plants</b>	basil, sage, rosemary, thyme, coriander, cumin, dill, camomile, dandelion, lavender
<b>Industrial crops</b>	cotton, oilseed rape, mustard, buckwheat
<b>Fodder</b>	lantern, clover

Given that in our conditions bee farming is not based on the provision of commercial pollination service to agricultural primary producers, pollination activity can be considered a positive externality from the economic theory point of view. Through pollination of wild plants and non-cultural crops, however, the whole of human society is the recipient of positive externalities. The term ecosystem service originates from environmental terminology and can be defined as a process or resource that provides nature to people (Schutyser & Condé, 2009). Hajdu (2007) considers pollination to be one of the main ecosystem services that also brings effects to society in the form of food production, natural medicines, social and cultural benefits.

The results of the authors who dealt with the economic evaluation of pollination activity of bees vary according to the methodology used. One recent attempt to estimate this value is reported by Gallai (2008). According to his calculations, he estimates the economic value of pollination activities in the field of world agriculture at € 153 billion. The team also states that this value represents 9.5% of the value of crops produced worldwide for human consumption.

Pimentel et al. (1997) estimate the value of pollination at \$ 200 billion. The author calculated the value of pollination for the USA and reached the worldwide result by extrapolation, considering that the value of pollination worldwide is at least five times higher than in the USA.

## **2.2 Methods for evaluating pollination activity of bees**

Pollination of crops with animal pollinators is an important ecosystem service for which there is no generally accepted valuation method (Winfree, Gross & Kremen, 2011). As mentioned above, pollination can be understood as an externality, as it represents the impact of the activity of one economic entity on another, and this impact is not subject to any market transaction. The problem of estimating the value of a pollination activity is therefore the fact that there is no functional market for the service and the market price of the service is therefore not known. The economic evaluation of such goods can thus be defined as an attempt to ascertain their value because there is no functioning market mechanism (Pagiola, Ritter & Bishop, 2004). The methodological apparatus for quantifying the value of ecosystem services, including pollination, is provided by economic discipline - environmental economics. Measurement approaches are divided according to the value of the ecosystem service being measured.

Pollination as an ecosystem service brings both use value and non-use value. The total value is given by their sum. The use value of pollination is determined, as in the case of land, for example, by an indirect value based on the demand and supply of pollinated crops and on the degree of crop dependence on pollination. Non-use value is more complicated because it is not associated with the consumer's use of the resource. The non-use value of pollination can also be understood as an indirect value, through the value of biodiversity conservation, in which bees are a major contributor to pollination.

The economic consequences of the pollinator deficit are dealt with in their work, for example Kevin & Phillips (2001). From an economic point of view, the price of a commodity reflects the cost of production, distribution, marketing and profit. The pollinator deficit may increase production costs as the cost of providing a pollination service will increase due to higher demand for this service. At the commodity market level, pollinator deficit causes a decrease in production, leading to a shift in the supply curve. This shift will lead to a new equilibrium price. Normally, the new price is higher than the original price, and the equilibrium amount is less. Evaluation through the production function approach is particularly suitable for evaluating ecosystem services that support economic activities and thus also for pollination (FAO 2006). A more detailed approach to the economics of pollination is provided by Southwick & Southwick (1992), dealing with supply and demand issues, costs and the impact of revenue changes. Their model makes it possible to assess the impact of pollinator deficit on the overall market. Obviously, if commodity producers adopt the same procedures to increase returns, supply will increase and prices will fall. Their model for economic analysis of pollinator deficit is not complicated.

The simplest is the economic model in which production and consumption occur in a closed system - in which there is no foreign trade. In this simple economic model, the quantity offered on the market corresponds to the demanded. The equilibrium price is  $P_0$  and quantity  $Q_0$  (Figure 1). The effect of the pollinator deficit shifts the supply curve  $S$  to the left, creating a new supply curve  $S_1$ . This shift will create a new  $E_1$  equilibrium in the northwest of the original equilibrium. In this new position, less product is consumed at a higher price  $P_1$ . The clear consequence of the pollinator deficit is that consumers are worse off because they consume less at a higher price. The impact on manufacturers is less clear. In the case of inflexible demand function (demand curve is vertical), manufacturers would benefit from the pollinator deficit, since the quantity sold would not change while the price would increase. Conversely, with flexible demand (horizontal demand curve), producers would be damaged by the pollinator

deficit. The net impact on producers and consumers therefore depends on the elasticity of supply and demand.

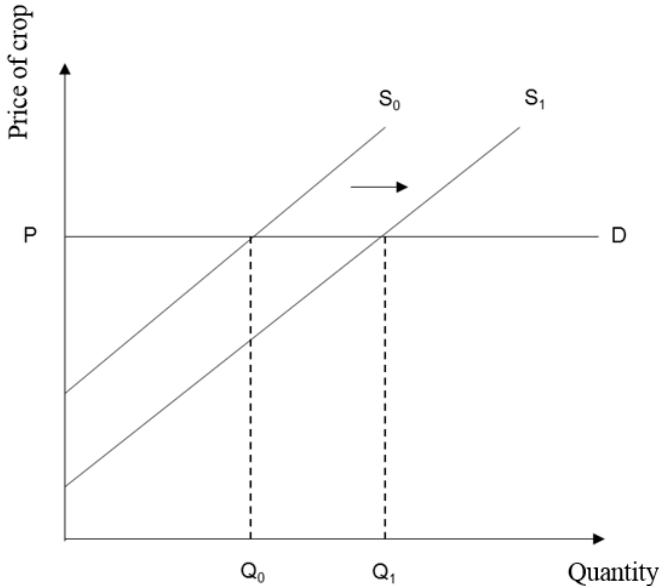

Fig. 1 – Effect of pollination on the pollination-dependent crop market.  
 Source: Kasina (2007); Levický & Gurčík (2014)

**3 METHODOLOGY**

We will use the bioeconomic approach to determine the value of pollination activity. The economic value of the pollination activity in this case is based on the price of the crop multiplied by a coefficient expressing the dependence of the crop on pollination by insects. The determination of the crop-pollination coefficient and the proportion of honey bees among pollinating insects is the result of several scientific work. Gallai (2008) sets out the following formula to determine the economic value of insect pollination:

$$EVP = \sum_{i=1}^I (P_i \cdot Q_i \cdot D_i) \tag{1}$$

- where *EVP* the economic value of insect pollination
- P<sub>i</sub>* price of crop *i* (per tonne)
- Q<sub>i</sub>* produced quantity of crop *i*
- D<sub>i</sub>* coefficient representing dependence on insect pollination; *D<sub>i</sub>* ∈ (0; 1)

Most authors dealing with the issue of ecosystem evaluation, or in particular evaluating pollination activity of bees or wild insects, state that any result of applying the chosen methodology can be considered as a rough estimate (Alebachew, 2018). We fully share this view for a number of reasons. Approaches to differentiate the methods of assessing bee pollination are based either on market data or on a hypothetical market. Both methods have disadvantages.

The problem with market-based methods is, in particular, the complicated availability of the necessary data. First of all, if we quantified the value of pollination activity of bees from a global perspective, we would have to consider changes in the amount of entomophilic crops that would be caused by the change in crop supply due to the change in pollination. Consequently, it would be necessary to identify demand and supply equations, to determine the

relevant elasticities and to quantify the change in overall welfare due to changes in the surpluses of consumers and producers. The situation would be simpler if we calculated the value of pollination at the local level. Assuming an open economy, the amount of crops that would be lower as a result of the pollinator deficit could be imported and thus the resulting impact on the market price would be zero. Such a situation is also assumed in our calculations. Another problem with market-based methods is the inability to obtain data on what part of the crops has actually been pollinated. In their articles, the authors consider the situation that all flowers of all crops were pollinated with the necessary amount of bees. This assumption will allow the use of measures of crop dependence on insect pollination, respectively pollination dependency ratio. Measures of crop dependence on pollination are available from scientific studies and agrobiological studies. Again, however, there is an obstacle in the form of sometimes considerable differences in the results of the experiments carried out. In studying the methods used, we have come across the fact that the authors often used these measures without geographical distinction in the works. In our opinion, the differences in published rates may be due to the different geographical conditions in which the research was conducted. We therefore consider it appropriate to apply the results of studies that have been conducted under conditions similar to those of a country where we quantify the value of pollination.

In relation to the degree of dependence of the crop on pollination, it should also be noted that there are several varieties within some plant species, which may be self-pollinating or alien-pollinating, and therefore the rates mentioned are different. The representation of individual varieties is mostly not kept statistics and therefore the value of pollination activity in scientific works is generalized to the species level. Since the value of pollination activity is quantified by this methodological approach derived from the market price of crops, the different marketability of crops may also be a problem, or it may be questionable to account for the value of pollination for crops subject to production consumption.

On the basis of the above, it can be said that the economic evaluation and valuation of bee pollination is a relatively demanding process, mainly due to the problematic availability of the necessary data and a number of different assumptions using those methods which are used it also complicates the comparison of results. Therefore, based on the general procedure for measuring biodiversity values (Klúvanková & Oravská 2006), it is necessary to be aware of the following when applying specific methodologies for assessing ecosystem service - pollination: (1) Measurement of pollination activity of bees is subjective. Some authors therefore call it an experiment or an estimate; (2) There is no universal methodology for measuring pollination activity values. Each evaluation study is unique and the methodology should be adapted to the purpose of the evaluation; (3) Based on the assumptions on which the assessment was based, it is the responsibility of the team of authors to ensure an unbiased interpretation of the results obtained.

## **4 RESULTS**

Crops that we included in the calculation of the value of pollination activity of bees were selected based on publications from Veselý (2007), Kopernický & Chlebo (2002), Popovič (2008) and Chlebo (2017), which mention crops for bees in Slovakia. Among them, we have chosen market crops, because the method used requires information on market prices for commodities. Other crops for which pollination activity does not directly support economic activities have not been included in the calculations, as the methodology used is not considered in determining the value of pollination activity. The limiting factor was the availability of data on producer prices and rates of dependence of individual crops on bee pollination. The crops included in the calculation are listed below, which also includes the actual evaluation of bee

pollination. We did not include vegetables among the selected crops because only a small number of vegetables need pollination to form the part of the plant to be finalized. The situation would be different only if the vegetables were grown for seed purposes. In order to form the part of the plant to be finalized, the pollination needs in particular the vegetable species of the herbaceous family. However, the degree of dependence of these plants on pollination is low and at the same time a large proportion of them are grown in hydroponic greenhouses without natural pollinator access. For this reason, we assume that the value of pollination will be low and therefore we abstract it from their inclusion in the calculation.

#### **4.1 Estimation of the value of pollination in conditions of the Slovak Republic**

The most important beekeeping crops have recently been oilseeds, which in the areas of intensive plant production in Slovakia provide the first and last rich food. The typical and generally well-known beekeeping crop is oilseed rape. Veselý (2007) reports that oilseed rape responds well to bee pollination. With 3 hives per hectare, crop yields increase by 30 to 35 %. Chlebo (2017) even mentions a crop increase of 116.60 %. It is suitable for bees because it provides them with plenty of nectar and pollen. In 2017 were cultivated 150 082 hectares of rapeseed in Slovakia. With the current number of bee colonies, there are approximately 2 colonies per hectare of rapeseed and thus it can be assumed that rapeseed stands in Slovakia have potential pollination. Popovič (2008) in his research states that in our conditions the dependence of oilseed rape on pollination reaches 22.5 %. This percentage indicates how much of the rape yield in kind was due to the pollination activity of bees.

Based on the available data and the methodology chosen, we can estimate that the value of bee pollination by bees was approximately € 37.88 mil. Sunflower was grown in Slovakia in 2017 on an area of 87 348 hectares. Unlike oilseed rape, it is not a spring crop in terms of pollination, but is typical of early autumn. Popovič (2008) reports that the percentage of dependence of bee pollination is for sunflower up to 61.8 %. Foreign authors report higher values of percent dependence on insect pollination. Morse & Claderone (2000) report the dependence of sunflower yields on insect pollination of 100 %, of which bee pollination represents 90 %. The value of pollination activity of bees for this crop in Slovakia can be estimated at approximately € 42.16 mil. Among oilseeds, we estimated the value of bee pollination activity for mustard and flax, which in total amounted to approximately € 682,000. More accurate results are shown in Table 2.

The beekeeping spring is characterized by the flowering of a whole range of fruit trees and shrubs. Although most fruit species are not a significant source of nectar for bees, the need for bee pollination for some fruits can be characterized as very high. Some of the fruit crop varieties are self-pollinating (autofertile). Popovič (2008), however, states in his research that bee pollination also yields a few tens of percent more in the case of self-pollinating varieties (e.g. sour cherries) compared to the non-pollinated state. In our conditions, the most represented fruit plant is apple tree. Popovič (2008) found that several apple varieties are completely dependent on bee pollination. In general, however, the apple varieties depend on pollination for 90.1 %. This means that if apple blossoms were pollinated by bees at the time of flowering, approximately 90 % of the crop could be attributed to the pollination activity of bees. The combination of a high proportion of apple production in fruit production and, at the same time, a high dependence of this type on pollination, means that the value of bee pollination in apple trees is the highest among all fruit plants. In 2017 we estimate it at € 12.22 mil. We also included a pear in our estimation of value of pollination. Pear can be classified as a crop with a high degree of dependence on pollination. Popovič (2008) reports the dependence of this tree species on bee pollination up to 92 %. In this case the pollination activity of bees has a value € 427,000. Veselý (2007) states that cherries, sour cherries and plums are also highly dependent on

pollination. Based on the available data, we quantified the value of pollination activity of bees of the cherries. In 2017 it reached the value of € 1.19 mil.

We also examined the value of pollination activity for peach and apricot. These crops have a mild need for pollination and their dependence on bee pollination is approximately 50 % according to Popovič (2008). The value of pollination activity of bees for peach can be calculated to € 465,000 and at apricot almost € 224,000. The least dependence on bee pollination among fruits is achieved by berries. More specific results for each berry are shown in Table 2.

Tab. 2 – Estimation of the value of pollination activity of bees in the Slovak Republic.

Source: Popovič (2008) and Faostat (2019)

Crop	Impact of pollination (coeff.)	Production (t)	Change in production (t)	Producer price (€·t <sup>-1</sup> )	Change in producers' income (€)
Sunflower	0,618	218 844	135 246	312	42 156 051
Oilseed rape	0,225	448 665	100 950	375	37 876 299
Mustard	0,855	1 531	1 309	511	668 247
Flax	0,025	1 593	40	342	13 620
Cherries	0,935	893	835	1 423	1 188 224
Apple	0,901	32 478	29 263	418	12 217 168
Pears	0,92	844	776	550	426 831
Peaches	0,48	1 544	741	628	465 423
Grapes	0,01	45 859	459	863	395 947
Strawberries	0,22	786	173	1 898	328 116
Apricots	0,56	333	186	1 200	223 776
Currants	0,154	38	6	928	5 432
Sour cherries	0,565	23	13	668	8 686
Plums	0,64	993	636	470	298 440
Σ					96 272 261

#### 4.2 Estimation of pollination value in the Czech Republic

Based on the available data, it can be concluded that the Czech Republic achieves better parameters in terms of bees per unit area than Slovakia. While in Slovakia there were 5.7 colonies per square kilometre in 2017, in the case of the Czech Republic it was up to 8.6 colonies. For the sake of simplicity, let us abstract from the territorial structure of bee colonies and crops and assume that crops have been fully pollinated. Due to very similar climatic conditions and the proximity of the countries, we included the same crops as in the case of Slovakia. The structure of crops dependent on pollination in the Czech Republic is very similar to that of Slovakia. In 2017, the intensity of oilseed rape growing was higher than in Slovakia and, since it is also one of the most important and most widespread bee crops, the value of pollination activity reaches the highest level. The value of bee pollination for oilseed rape is estimated at more than € 103 mil. The other crops in terms of the value of pollination activity are apple trees and sunflowers. The value of pollination activity for individual crops that we have included in the calculation is shown in Table 3. The total value of pollination activity under the conditions of the Czech Republic for 2017 is estimated at € 164 630 322.

Tab. 3 – Estimation of the value of pollination activity of bees in the Czech Republic.

Source: Popovič (2008) and Faostat (2019)

Crop	Impact of pollination (coeff.)	Production (t)	Change in production (t)	Producer price (€.t <sup>-1</sup> )	Change in producers' income (€)
Sunflower	0,618	53 156	32 850	339	11 145 630
Oilseed rape	0,225	1 146 224	257 900	402	103 577 487
Mustard	0,855	9 542	8 158	572	4 666 464
Flax	0,025	2 349	59	581	34 147
Cherries	0,935	1 999	1 869	1 527	2 854 573
Apple	0,901	105 280	94 857	355	33 676 749
Pears	0,92	3 947	3 631	586	2 127 902
Peaches	0,48	485	233	865	201 425
Grapes	0,01	79 774	798	741	590 896
Strawberries	0,22	2 827	622	2 937	1 826 769
Apricots	0,56	1019	571	996	568 624
Currants	0,154	1609	248	533	132 049
Sour cherries	0,565	4202	2 374	721	1 711 473
Plums	0,64	4 065	2 602	583	1 516 134
Σ					164 630 322

## 5 CONCLUSION

Beekeeping is an important part of modern agriculture, both in the production of bee products and in the provision of pollination services (Mladenovic, Orovic & Milosavljevic, 2011). In this paper we made an estimate of the value of pollination activity of bees for the Slovak and Czech Republic for 2017. We used a bioeconomic approach, which focuses on the use value of pollination. Based on the chosen methodology, it can be stated that in the case of the Slovak Republic the value of bee pollination was € 96 272 261. In the case of the Czech Republic, the value of pollination was € 164 630 322. The advantage of both countries is that the number of bee colonies is relatively sufficient. From the neighbouring countries, there is another situation in Poland, for example, where existing bee colonies can only cover 53% of the pollination needs. In 2012, the value of pollination was estimated at € 825.1 million and at the same time the economic value lost by the pollination deficit was quantified at € 728.50 million (Majewski, 2014). The example of Poland, but also of other European countries where there is a deficit of pollinators, is also related to the issue of food security and global warming. In the case of a pollinator deficit, the pressure on food production could negatively contribute to the need for agricultural land expansion and thus negatively contribute to negative global environmental changes (Aizen et al., 2009).

### Acknowledgements

This article was supported by the University Grant Agency of the University of Constantine the Philosopher in Nitra through the research project UGA VII/10/2019.

## References

- Aizen, M. A., Garibaldi, L. A., Cunningham, S. A., & Klein, A. M. (2009). How much does agriculture depend on pollinators? Lessons from long-term trends in crop production. *Annals of Botany*, 103(9), 1579-1588. doi: 10.1093/aob/mcp076
- Alebachew, G. W. (2018). Economic value of pollination service of agricultural crops in Ethiopia: Biological pollinators. *Journal of apicultural science*, 62(2), 265-273. doi: 10.2478/JAS-2018-0024
- Allsopp, M. H., Lange, J. L., & Veldtman, R. (2008). Valuing Insect Pollination Services with Cost of Replacement. *PLoS ONE*, 3(9), 1-8. doi: /10.1371/journal.pone.0003128
- Carreck, N., & Williams, I. H. (1998). The economic value of bees in the UK. *Bee World*, 79(3), 115-123. doi: 10.1080/0005772X.1998.11099393
- Corbet, S. S., Williams, I. H., & Osborne, J. L. (1991). Bees and the pollination of crops and wild flowers in the European Community. *Bee World*, 72(2), 47-59. doi: 10.1080/0005772X.1991.11099079
- Diemerová, I. (1995). *Úspešné včelárenie*. Bratislava: Kontakt plus.
- FAO. (2006). *Economic Valuation of Pollination Services: Review of Methods*. Retrieved from Food and Agriculture Organization of the United Nations: <http://www.fao.org/fileadmin/templates/agphome/documents/Biodiversity-pollination/econvaluepoll1.pdf>
- Faostat. (2019). *FAOSTAT database*. Retrieved from <http://faostat.fao.org/>
- Fisher, B., Turner, K., & Morling, P. (2009). Defining and classifying ecosystem services for decision making. *Ecological Economics*, 68(3), 643-653. doi: 10.1016/j.ecolecon.2008.09.014
- Gallai, N., Salles, J. M., Settele, J., & Vaissiere, B. E. (2008). Economic valuation of the vulnerability of world agriculture confronted with pollinator decline. *Ecological economics*. 68(3), 810-821. doi: 10.1016/j.ecolecon.2008.06.014
- Hein, L. (2009). The Economic Value of the Pollination Service, a Review Across Scales. *The Open Ecology Journal*, 2. doi: 10.2174/1874213000902010074
- Chlebo, R. (2017). *Podmienky rozvoja včelárstva na Slovensku*. Nitra: Slovenská poľnohospodárska univerzita.
- Kasina, J. M. (2007). Bee Pollinators and Economic Importance of Pollination in Crop Production: Case of Kakamega, Western Kenya. Retrieved from Institut für Nutzpflanzenwissenschaften und Ressourcenschutz: <http://hss.ulb.uni-bonn.de/2007/1199/1199.pdf>
- Klein, A. M., Vaissière, B. E., Cane, J. H., Dewenter, I. S., Cunningham, S. A., Kremen, C., & Tscharntke, T. (2007). Importance of pollinators in changing landscapes for world crops. *Proceedings of the Royal Society*. 274(1608), 303-313. doi: 10.1098/rspb.2006.3721
- Klúvanková-Oravská, T. (2006). *Úvod do ekonomického hodnotenia a oceňovania biodiverzity: Učebné texty pre všetky formy vzdelávania*. Nitra: Slovenská poľnohospodárska univerzita.
- Kopernický, M. & Chlebo, R. (2002). *Včelárstvo*. Nitra: Slovenská poľnohospodárska univerzita.



- Lampeitl, F. (1995). *Bienen halten*. Stuttgart: Eugen Ulmer.
- Levický, M., & Gurčík, E. (2014). *Ekonomické a manažérske faktory chovu včelstiev na Slovensku*. Nitra: Slovenská poľnohospodárska univerzita.
- Madras-Majewska, B., & Majewski, J. (2016). Importance of bees in pollination of crops in the European Union countries. *Economic Science for Rural Development*, 42, 114-119. Retrieved from <http://search.ebscohost.com/login.aspx?direct=true&db=e5h&AN=115474371&lang=cs&site=eds-live>
- Majewski, J. (2014). Economic value of pollination of major crops in Poland in 2012. *Economic Science for Rural Development*, 34, 14-21. Retrieved from <http://search.ebscohost.com/login.aspx?direct=true&db=e5h&AN=96043765&lang=cs&site=eds-live>
- Mladenovic, M., Orovic, D. G., & Milosavljevic, S. M. (2011). Effect of increasing the profitability of production capacity in the beekeeping. *Economics of Agriculture*, 58(1), 349-357. Retrieved from <http://ea.bg.ac.rs/index.php/EA/article/view/846>
- Pimentel, D., Wilson, C., McCullum, C., Huang, R., Dwen, P., Flack, J., Tran, Q., Saltman, T., & Cliff, B. (1997). Economic and Environmental Benefits of Biodiversity. *BioScience*, 47(11), 747-757. doi: 10.2307/1313097
- Popovič, I. (2008). *Včela medonosná - dôležitý biologický úrodovný činiteľ vybraných plodín*. Unpublished material for the training course Beekeeping Minimum.
- Špyrka, M. (1989). *Ekonomika poľnohospodárstva*. Bratislava: Príroda.
- Vanyi, G. A., Csapo, Z., & Karpati, L. (2011). Honey production and its externality effects. *Economics of Agriculture*, 57(2), 409-418. Retrieved from <http://www.ea.bg.ac.rs/index.php/EA/article/view/1019>
- Veselý, V. et al. (2007). *Včelařství*. Praha: Brázda.
- Williams, I. H. (1996). Aspects of bee diversity and crop pollination in the European Union. *Linnaean Society Symposium Series*, 18, 63-80. Retrieved from <https://www.tib.eu/en/search/id/BLCP%3ACN013523995/Aspects-of-bee-diversity-and-crop-pollination-in/>
- Winfrey, R., Gross, B. J., & Kremen, C. (2011). Valuing pollination services to agriculture. *Ecological Economics*, 71(1), 80-88. doi: 10.1016/j.ecolecon.2011.08.001

## Contact information

### Ing. Michal Levický, PhD.

Constantine the Philosopher University in Nitra, Faculty of Natural Sciences  
Tr. A. Hlinku 1, 94974, Nitra, Slovak Republic  
E-mail: mlevicky@gmail.com  
ORCID: 0000-0002-5297-1664

doi: 10.7441/dokbat.2019.062

# BEYOND THE SCALES: CONCEPTUAL DISCUSSION OF STRUCTURAL EMPOWERMENT BASED ON IN-DEPTH INTERVIEWS

*Ivana Lukeš Rybanská, Šárka Nováková*

## **Abstract**

Empowerment has been a popular trend in management for decades. However, there are still gaps in the complete understanding of this phenomenon. In the theoretical part of this paper, we show that structural empowerment is not a clear concept in research or practice. Thus, this paper highlights weak spots of the commonly used scale for measuring structural empowerment. Later this conceptual base is discussed with the empirical material from three Czech organizations. These organizations from the different business areas were chosen based on their unusual way of organizing and attitude to power. Semi-structured interviews with employees enabled us to inquire about facets of structural empowerment carefully. It leads to the critique of three sections of the structural empowerment questionnaire (access to information, formal power, and informal power). Our findings support the importance of different aspects of empowerment - especially information, trust, and networks concerning the fact that empowerment is dynamic and situated in relationships. It reveals the complexity of empowerment because it can not be created or enhanced by a single intervention. Therefore, more empirical work should be done to depict how power is handled within structural features in nowadays organizations. In addition, the suggestions for improvement of the structural empowerment scale was made to be verified in future research.

*Keywords: empowerment, structural empowerment, CWEQ-II, qualitative study*

## **1 INTRODUCTION**

This paper shows structural empowerment patterns that occur in studied organizations and uses them for discussion of questionnaire items utilized for measuring employee empowerment.

We studied three Czech organizations (their selection and characteristics are specified in the Methods section) describe themselves as experimenting with their organization model or non-hierarchical. What these three organizations have in common is that at the end of the day, they experiment with how power is distributed within the organization. This question brings us to empowerment - not as a fancy management trend but a dynamic analytical concept directly connected with the power relations inside the organization. In this paper, we do not debate in detail the organization models of studied organizations. In our analysis, we take as granted that the organization model sets rules, divides competencies inside the organization, and both with competencies and rules, power comes.

This paper begins with a short discussion of the empowerment concept and how it is currently measured. This summary also explains our need to inquire about empowerment - again. Then we explain how our semi-structured interviews from three Czech companies were analysed in proximity to the questionnaire supposedly measuring structural empowerment. The analysis section walks the reader through the weak spots in the questionnaire „Conditions for Work Effectiveness Questionnaire II“ (CWEQ-II) and offers our suggestions for conceptual improvement in understanding of the empowerment phenomenon.

## 2 THEORETICAL BACKGROUND

### 2.1 Empowerment – a crossroad of meanings

The promise of having happier and more productive employees has been drawing managers' attention to the concept of empowerment from the glossy pages of business journals for decades. A wide range of interventions inside organizations attempts to empower employees. However, what this means in real life of organizations differs extensively. This diversity and lack of detail may also be the cause of why this fashionable phenomenon is often described as unsuccessful (Seibert, Wang & Courtright, 2011).

The concept of empowerment is obscurely used among practitioners as well as among academics. This situation contributes to misunderstanding and subsequent failing of empowerment in practice (Bartunek & Spreitzer, 2006; Lincoln et al., 2002). There are multiple perspectives from which we can look at the phenomenon of empowerment. It can be seen as the transmission of power where one gains and one loses (Burke, 1986) or as finding and releasing the power of the individual that they already have (Randolph, 1995). Bartunek and Spreitzer (2006) distinguish between empowering practices according to their primary focus – human-centred (the welfare of employees is the primary concern) or profit-centred (the productivity and increasing the profit are the main focus).

Academic literature prevalently features two types of empowerment. First is the structural (also called social-structural) empowerment. This type stems from Rosabeth Moss Kanter's major study *Men and Women of the Corporation* (Kanter, 1993), where essential resources of power and conditions for enhancing empowerment are described. This work is often referenced in papers as the grounding work for empowerment research. Unlike most of the empowerment research, this book is based on extensive qualitative research and is concerned with organizations as structures for individual behaviour. To us, this often seems to be omitted by the mainstream empowerment scholarship and the scales for measuring empowerment.

The second type is psychological empowerment, which has evolved as a motivational construct from the research of intrinsic motivation. In this understanding, feeling empowered enables employees to act in a more self-determined way and enhance their motivation by increasing their feelings of self-efficacy (Conger & Kanungo, 1988). Currently used definition of psychological empowerment refers to „a set of psychological states that are necessary for individuals to feel a sense of control in relation to their work“ (Spreitzer, 2008). Four dimensions constitute this concept – meaning, competence, self-determination, and impact and are subsequently turned into sections of the questionnaire (Spreitzer, 1995).

Later in this paper, when referring to empowerment, we have structural empowerment in mind. We have settled on this focal point for our analysis because there is an ongoing discussion about the existence of structural empowerment, which is founded on the argument that the presence of the empowering tools does not automatically mean empowered employees (Spreitzer, 2008). Therefore some scholars talk about the antecedents of psychological empowerment rather than the (structural) empowerment (Seibert, Silver & Randolph, 2004). These antecedents are for example organizational structure (Harley, 1999), trust (Ergeneli, Ari & Metin, 2007), organizational justice (Kuokkanen et al., 2014), feedback (Gagné, Senécal & Koestner, 1997; Hon & Rensvold, 2006), support of innovation (Çekmecelioğlu & Özbağ, 2016), person-organization fit (Gregory, Albritton & Osmonbekov, 2010) or internal marketing (Yao, Chen & Cai, 2013). Similar meaning to structural empowerment also bears the notion of empowerment climate (Seibert, Silver & Randolph, 2004; Tuuli et al., 2012). This flood of concepts and standpoints for describing roughly similar empirical reality does not make it easy for practitioners and their usage of academic knowledge in practice. Thus, we attempt in this

paper to go back to the very first account of structural empowerment (Kanter, 1993) and – informed by the discussions described above – to locate new directions for an improved measurement of structural empowerment.

## **2.2 Empowerment – a failing fancy concept?**

Empowerment typically fails in two ways. One is roots in the blurred concept itself (Jo & Park, 2016), and the other is – as is usually the case in management – tied with implementation (Van Bogaert et al., 2016). Empowerment initiatives fail to deliver their promises because the power is not transferred to employees – what the term actually implies – but still rests in the hands of the superiors or management (Harley, 1999; Kanter, 1993) and the initiative sugar-coats unequal power relationship and tries to improve organization’s reputation (Staw & Epstein, 2000). This shallow understanding of the empowerment concept often goes hand in hand with understanding power as a commodity that can be handed over like a phone (Eylon, 1998). Thus, we can read about the drawbacks of empowerment, which include limiting “the ability of managers to optimize the allocation of work tasks and ensure a coordinated response” (Biron & Bamberger, 2010). Our paper focuses on this dimension of a problem with empowerment, which we label conceptual. With our empirical material, we seek to shed light on how empowered employees think and act and which structural features of organization enabled their empowerment.

Inspired by these assumed failures of the concept, we work with empowerment as a dynamic phenomenon. Necessarily, everything that touches power is dynamic and cannot be considered as an action-effect intervention but rests in the nest of relationships, negotiation, social capital, and interpretation of actions and words of everyone present in the company (Hodson, 2005; Fleming & Spicer, 2008). In this light, empowerment is an attempt to change the power balance inside the organization (Fleming & Spicer, 2008; Magee & Galinsky, 2008) and strengthening the power of those who usually were considered as powerless.

## **2.3 Measuring empowerment**

The last part of the preceding section could leave the impression that empowerment is either connected with everything and equally may be nothing. However, teams of researchers attempt to measure empowerment (often not bothering much with definition) with the outlook to capture the effectivity of initiatives introducing “more” empowerment to workplaces.

As we have presented above, empowerment is commonly understood as the psychological – individual – empowerment, the feeling of being empowered. The difficulties of measuring psychological empowerment we leave to the field of psychology. Here we focus on the organizational dimension of empowerment – the structural empowerment as it is understood by Laschinger et al. (2001) and consisting of access to opportunity, resources, information, support, formal and informal power. Two reasons led us this way. Firstly, it is based on original Kanter’s research and theory built upon it what takes us back to the beginnings of empowerment scholarship. Secondly, the scale developed by Laschinger et al. (2001) is, to the best of our knowledge, widely used and respected. The scale is called „Conditions for Work Effectiveness II“ (CWEQ-II) and it is mainly used in the healthcare environment (Knol & Van Linge, 2009). Items from this questionnaire and concepts which they supposedly address are presented in Table 1. The final section, called “Overall” was not used in our analysis due to its broad meaning and vague connection to the empowerment phenomenon. We would also like to point out one divergence from the original theory. The third structural determinant of organizational behaviour as identified by Kanter (1993) – proportion – which captures the homogeneity or heterogeneity of the organization and its influence on the dynamic between substantial social

groups, is completely missing in the Laschinger's et al. (2001) questionnaire without an explanation.

Tab. 1 – Conditions for Work Effectiveness Questionnaire I and II. Source: Laschinger (2012)

<p><b>How much of each kind of opportunity do you have in your present job? (none, some, a lot)</b></p> <ul style="list-style-type: none"> <li>• Challenging work</li> <li>• The chance to gain new skills and knowledge on the job.</li> <li>• Tasks that use all of your own skills and knowledge.</li> </ul>	<p><b>Access to Opportunity</b></p>
<p><b>How much access to information do you have in your present job? (no knowledge, some knowledge, know a lot)</b></p> <ul style="list-style-type: none"> <li>• The current state of the hospital.</li> <li>• The values of top management.</li> <li>• The goals of top management.</li> </ul>	<p><b>Access to Information</b></p>
<p><b>How much access to support do you have in your present job? (N/S/L)</b></p> <ul style="list-style-type: none"> <li>• Specific information about things you do well.</li> <li>• Specific comments about things you could improve.</li> <li>• Helpful hints or problem solving advice.</li> </ul>	<p><b>Access to Support</b></p>
<p><b>How much access to resources do you have in your present job? (N/S/L)</b></p> <ul style="list-style-type: none"> <li>• Time available to do necessary paperwork.</li> <li>• Time available to accomplish job requirements.</li> <li>• Acquiring temporary help when needed.</li> </ul>	<p><b>Access to Resources</b></p>
<p><b>In my work setting/job: (None, a lot)</b></p> <ul style="list-style-type: none"> <li>• The rewards for innovation on the job are</li> <li>• The amount of flexibility in my job is</li> <li>• The amount of visibility of my work-related activities within the institution is</li> </ul>	<p><b>Job Activities Scale (Formal Power)</b></p>
<p><b>How much opportunity do you have for these activities in your present job? (none, a lot)</b></p> <ul style="list-style-type: none"> <li>• Collaboration on patient care with physicians</li> <li>• Being sought out by peers for help with problems</li> <li>• Being sought out by managers for help with problem</li> <li>• Seeking out ideas from professional other than physicians, e.g. physiotherapists, occupational therapists, dieticians.</li> </ul>	<p><b>Organizational Relationships Scale (Informal Power)</b></p>
<p><b>Overall</b></p> <ul style="list-style-type: none"> <li>• Overall my current work environment empowers me to accomplish my work in an effective manner.</li> <li>• Overall, I consider my workplace to be an empowering environment. (strongly disagree, strongly agree)</li> </ul>	<p><b>Not used in the analysis</b></p>

As we have mentioned, CWEQ-II was designed and is used in the domain of healthcare. There are efforts to apply CWEQ-II in other sectors, for instance, banking (Jaffery & Farooq, 2015), education (Orgambidez-Ramos & Borrego-Alés, 2014; Kaya & Altinkurt, 2018), construction (Tuuli et al., 2012) and non-profit organizations (Allen et al., 2018). This whole body of research studied empowerment quantitatively. The few qualitative studies are mostly concerned with obstacles during implementation – empowerment as an obligation, insufficient information, or reluctance to be involved in internal governance (Bogaert et al., 2016). Studies on structural empowerment are rare and thus, there is also a lack of qualitative studies exploring the nature of structural empowerment within various organizations in today's world. Realizing this situation leads us to design our paper differently, as will be shown in the next section.

### 3 METHODS AND STEPS OF ANALYSIS

This paper moves back and forth between a qualitative and quantitative approach to the study of organizations. We are persuaded that continued discussion between these branches proves to be fruitful to the study of management phenomena such as empowerment. Moving closer to

and back to a more abstract level of life in organizations helps to pose intriguing questions and address the needs of real people in real situations.

We find it useful to comment on some items of the questionnaire to understand our reasoning in the analysis. The section concerning access to information is problematic in the view of the scope because it takes into account exclusively strategic information. However, people in various positions need distinct information to act, and they attach varying importance to each information. In terms of access to support, it is important to say that items describe feedback and support in the form of advice. Emotional support, peers' support (Liden, Wayne & Sparrowe, 2000), or perceived organizational support (Yildirim & Naktiyok, 2017) are not covered at all. The section on access to resources in CWEQ-II relates to time, whereas finance, material supplies, and other assets are not present. The section Job activities insufficiently capture how formal power is distributed in the organization or how the organization reflects power in its structure. Apart from the fact that sections Formal and Informal power "can be omitted" (Laschinger, 2012), the section formal power, as presented in CWEQ-II, considerably overlaps with psychological empowerment. The section informal power deals with organizational relationships but only as a collaboration of people in different positions. It does not work with alternative power bases or other types of relationships within the organization, such as teams and peers. Multiple problematic areas listed above will be addressed in the analytical part of this paper.

### **3.1 Choices during data collection**

Analytical corpus for this paper consists of 31 in-depth semi structured interviews, which were conducted during the summer and autumn 2018 in three Czech organizations. One of them is a manufacturer, another software developer, and the last one organizes various educational activities (from a legal standpoint, it is an NGO). These three were selected because of their diverse approach to designing their organization structure and the power setting inside the organizations. Each of them, in its unique way, attempt to have a less-hierarchical arrangement. From this fact, we conclude that empowerment tendencies are fundamental accompanying factors.

The group of interviewees in each organization was selected to reflect proportions between different groups (in terms of age, sex, position in the organization, and seniority) inside the organization. Ten, respectively eleven, semi-structured interviews were conducted in each of the three organizations. The structure of the interview covered main topics, which were connected, according to our literature review, with empowerment: opportunities for future learning, information sharing strategies, informal networks, strategies for dealing with problems, the meaning of work and feedback. The respondents are anonymized and detached from their respective organizations, because this information is not important for the arguments in this paper. The quotations are presented in italics and we can trace them to the original material according to the number in brackets. We translated the quotes from Czech to English, intending to present as much authenticity as possible.

### **3.2 Procedure for analysis**

The statements from the CWEQ-II, as presented in Table 1, served as the starting point of the analysis. We started with the original statements in the questionnaire and partial concepts of empowerment, as described by the authors of the questionnaire. We looked up for similar formulations in our research material in order to get deeply familiar with the meaning of them. After this, we looked for analogous formulations to those present in the questionnaire. This material created the basis for our arguments about the empowerment phenomenon presented in the following analytical section.

## 4 ANALYSIS AND RESULTS

In the previous section, we have pointed out questionable moments in CWEQ-II and how it addresses structural empowerment. Our analysis of interviews in a beneficial way enlightened three of the overall six sections. Here we focus on access to information, informal and formal power. In general, we argue for taking structural empowerment more into consideration because it offers insights that cannot be mediated by psychological empowerment. With our empirical material, we attempt to illustrate possible venues for an improved measurement of structural empowerment by pointing out to more specific structural patterns. Current items in the questionnaire are, in our opinion, vague and produce misleading expectations from the concept of empowerment.

### 4.1 Access to information

Mainstream management literature claims that people in any organization should have in mind the big picture, they should see their tasks as a part of the larger whole, so they do not feel lost or lack of motivation (Drucker, 2018). This is reflected in CWEQ-II as knowledge about the strategic goals and values of the organization (or its managers' perception of it). Slogans, strategic goals, and mottos, however, seem to be far away from the reality of organizational life and were absent from our respondents' talk. The expected big picture seemed to be present in a more tangible way – in the processes, pipelines, life cycles of projects, which together create something that one of our respondents enthusiastically called – “the whole”.

*“Actually, I see everything, the whole. I can see it from the beginning to the end, how it works, why it works, what it does.” (I01)*

The complex view of processes in the organization and information about the work of others is this big picture visible to employees. Referring to strategic goals as presented by the management can be a bit ironic (in cases when employees do not have the opportunity to influence these goals) because the employees compare them with reality and can interpret them as empty words. However, it is this functional understanding of “the whole,” which enables employees to contribute to the realization of these goals.

Besides the level of processes, people need various operational information to act and “use their power.” The immediate availability or frequent update of many operational documents (e.g. production plans, budgets) could fulfil – in the sense of disclosure, clarity, and accuracy – the call for transparency (Schnackenberg & Tomlinson, 2016). The absence of this information is strongly felt, especially in the so-called first line.

*“I think in the office there are some sort of production meetings, where they have some of the information from higher places, and some of the information should be passed to us, right. We think. Because we really don't have that kind of information that people should know.” (I16)*

The effort of organizations to actively share the information was strongly present in all three organizations – the respondents described boards covered with spreadsheets, information about new employees in the restrooms, funnily writing the internal company newsletter, having bi-annual meetings for sharing plans and activities throughout the organization. Still, this was identified as something to improve.

*“I think there could be something more to do, how to bring it closer to the new people, yeah, that is can be hard to grasp everything from the materials.” (I14)*

*“We put information about the newcomers to the toilets (...). Paradoxically, if we want one to notice, the toilet is the best place. In fact, more people will notice the information on the door of the restroom than when we send an information email.” (I07)*

The mere passive availability of the information (e.g. wiki-page, shared document storage) often is not enough due to various obstacles – for example, people may not know what to look for, where to look, or they cannot distinguish the relevant pieces of information.

Except for the access to information itself, the personal perception of the information importance is pertinent. People do not pay much information that they do not consider as viable to their work. The organization, in this case, fails to show the relevant information or to show the relevance of the information.

*“I don't even watch it, I don't know what it is, because I actually come here and come to the workplace and I know what to do and I don't need..., I find it a bit unnecessary, I guess it's interesting, sure, but not for me, I don't even have time to go there and look at it.” (I20)*

Intertwining online and offline environment, using humour, these are some examples of what organizations can do to support active access to information. Because information that is made (structurally) available is effective in terms of empowering employees only when employees can act upon it. When talking about action, we mean action or agency in a broad sense – enabling actors to plan, strategize, come up with their solutions, interpret, adapt to, and question information that circulates inside the organization (Brummans, 2018).

Nevertheless, access to information can also have its dark sides, which are completely hidden when using CWEQ-II. It is the issue of information overload, which freezes actors in structurally empowering environments – either because it takes a lot of attention capacity or that there are multiple platforms for different types of content, and there is hard to navigate these systems. Further research needs to be done on this connection and possible effects of information overload on empowerment.

## **4.2 Formal power**

Formal power is related to the formal position, rewards, and recognition that the organization attributes to individuals (Kanter, 1993). A later understanding of formal power that includes flexibility and visibility of work as presented in CWEQ-II blurs the ability to utilize empowerment in a complex way as it overlaps with dimensions of psychological empowerment, specifically self-determination and impact. The main problem is not in factors themselves but the diversion of the items from the structural aspect. This section discusses the specific situations where formal power was identified.

In the broadest sense, the item “The amount of flexibility in my job is... (None, a lot)” addresses the issue of autonomy among organizational units (teams, divisions, ad hoc working groups). Here “the most empowered” position is “...every project manager and every team can do things in their way” (I08) or its variations, which were recorded in all three organizations. When we look at the details of this power to do things in every possible way, we see differences in the way in which formal procedures for feedback, control, and planning are used.

Another item, “The amount of visibility of my work-related activities within the institution is (None, a lot),” does not unambiguously imply the structural attribute and can be confused with impact in psychological empowerment. What we have heard from the respondents points out something different.

*“I click on some cell in Excel and everyone will work with my materials, at least half of the organization, and what if I screw something up?! That will affect the whole organization.” (I01)*

This quote does not speak about visibility, but the realization of one's individual influence on the whole. This impact of individuals' work can also have a negative feeling attached – I could ruin this. Our respondents have talked about this structural aspect positively and described it as



a motivating factor or the reason for developing personal control mechanisms for their own work.

This situation of high personal impact was connected to the issue of trust, being entrusted. Trustful relationships across the organization can influence empowerment (Robbins, Crino & Fredendall, 2002) and they can be influenced by empowerment (Berraies, Chaher & Ben Yahia, 2014). One can hardly imagine that superiors or the organization attempt to empower employees whom they do not trust.

In contrast with two different definitions of trust - as goodwill or as predictability, we employ the conceptualization of trust as communication for which argues Hardy et al. (1998). "Trust rests on reciprocal communication, and does not involve communication undertaken in order to sustain asymmetrical power relations or to exploit power reserves. In this way, predictability arises from shared meaning; while goodwill arises from the participation of all partners in the communication process whereby this shared meaning is created" (Hardy et al., 1998). Trust, in this way, enables the increase of the legitimacy of actions conducted by people all kinds of positions, but especially of those in positions of formal power.

*"I feel trust from people who feel they need this position – that is Kristyna or the head of the company. I feel it is done according to me and if I say something is not going to happen, it's not." (I05)*

Also, trust from peers and subordinates seems to accompany formal power because it fulfils its legitimacy, as the following quote shows.

*"Oh, there are so many people who cannot do it [say hello to everyone], who don't know it, don't know the role of the supervisor. It is important. It is the supervisor that is important. Some of them cannot handle it many times. There are some, whom I won't name, but there are some supervisors who don't say hello when they walk by, they act as if they don't know you." (I27)*

With a formal position, there come expectations about fulfilling that role. When one does not fit the way how power relations are enacted in the organization (such as being friendly and caring), the legitimacy of this person is lower. Of course, organizations that structurally support detachment between supervised and supervisors, between the layers of the hierarchy could have an opposite effect.

### **4.3 Informal power**

Informal and formal power are mutually dependent. The intersection can be seen in the issue of trust. When considering trust as communication (Hardy et al., 1998) – when addressing formal power, it gives additional legitimacy to the action; when addressing informal power, it enables to decide whom to contact when seeking help or looking for support. Laschinger et al. (2001) scale presents individual's informal power as her ability to help others, give them access to information, and share their experience or expertise. When we looked more closely at the moments in which respondents spoke about their informal power, we identified situations that addressed building friendships and other building blocks of informal authority (seniority, expertise, popularity).

Organizations are made of people, and people are not sources functioning alone without interaction with others on a personal level. This personal, even intimate, element of relations at work is often overlooked, although it seems to play a crucial role in some situations.

*"When we were in the mountains (...) we spent all day together (...) how good they are, yeah, normally, humanly, personally, off the job, and it made me feel even more like that, it influenced how our relationships work now." (I18)*

These experiences out of work add another layer to usual interactions, create bonds, and strengthen relationships. These off-duty experiences can supply leverage for one's influence, and the credibility perceived by closer peers is higher.

*"(...) so she actually became my friend (...) I am maybe even more sensitive when she talks about her work in front of my team, so I am automatically more interested (...) and I care more about it, maybe it's because I understand it a little bit more than any other thing.(...)" (I04)*

Respondents repeatedly mentioned informal authority based on seniority, expertise, or popularity in the organization.

*"(...) when you are just the oldest, they like... or the longer you work here, so everyone is looking up to you and they automatically accept you." (I12)*

*"(...) when it ends and people applaud, there is a standing ovation and people shout (...) Even in everyday situations, when people meet me and say hello with smile or they say I have an idea for you - we will do this and that, it's like I am not useless here and I can maybe help them with something (...)" (I06)*

*"And then, of course, the others come and ask me when they don't know something, how to follow procedures in finance, how to get a deposit, how to do it and so on." (I18)*

This informal authority can constitute informal power inside the organization and bolster the feeling of empowerment.

## **5 DISCUSSION**

In the analysis, we inquired closely three parts of Conditions for Work Effectiveness Questionnaire II (CWEQ-II), namely access to information, formal power, and informal power. Our material showed that networking accompanied by shared personal experiences shapes relationships that are permeated with trust. It is in line with Kanter's research that emphasizes networks as an essential base of power in organizations (Kanter, 1993). Our reasoning approximated informal and formal power with the issue of trust. It echoes scholarship on organizational behaviour, which presents trust as the inseparable pillar of formal power since it makes "interorganizational relations function more effectively" (Hardy et al., 1998). The connection between trust and empowerment is discussed by Maynard, Gilson and Mathieu (2012), who conclude that researchers often focus on trust in leaders or superiors while overlooking alternative trust-based relationships. This paper contributed to this line of inquiry.

The main take-away for practitioners from our research can be that all structural patterns have to be bolstered by the relevant information which employees can act on, support active sharing of this information, and enable the complete knowledge of organizational processes, pipelines, and life cycles of projects. This finding contributes to structural empowerment theory by recognizing the importance of employee's perception of the information because the authors usually look on the information from the managers' or organization's perspective – for instance strategic information (Laschinger et al., 2001) or performance information (Spreitzer, 1995; Bartram et al., 2014).

We propose a modified version of three sections of CWEQ-II (access to information, formal power, and informal power). This revisited version is built on our analysis and partially on Kanter's research as the conclusions for structural empowerment were not substantially challenged neither by our analysis or other available scholarship on empowerment. Our idea is to abandon the measurement of empowerment with scales and, for the sake of clarity and usefulness for organizations, substitute it with much simpler statements address the individual perception of known structural features. We present our preliminary and not tested draft

questionnaire addressing three discussed parts of structural empowerment (access to information and formal power) in Table 2 with the aim to spark discussion and find more accurate ways for identifying structural empowerment in organizations.

Tab. 2 – Preliminary and partial draft of a questionnaire. Source: own research

<b>Access to information</b>	Do you have access to all operational information you need for your work?
	How much effort do you have to spend to get this type of information? Is the relevant information easily accessible?
	Do you have enough general information about the organization, such as strategic goals, yearly plans, and similar?
	How much effort do you have to spend to get this type of information? Is the relevant information easily accessible?
<b>Formal power</b>	Does your position in the organization give you an ability to influence the way other people work?
	Does your position in the organization able you to influence general goals, plans, or direction of the organization?
	Is your contribution to the functioning of the organization sufficiently recognized by the organization?
	Do you perceive your salary to be a fair appreciation of your contribution?
	Do you feel that the organization trusts you?
	Do you believe that the organization's motives are good?
<b>Informal power</b>	How often do people in your organization seek help from you?
	Are people from your organization looking for your support?
	Do you have amicable relationships within the organization?
	Do people attribute more credibility to your actions than to the actions of others?

## 5.1 Limitations

Limits of this discussion are set by the research design applied. Choosing different organizations but from one country is not rich enough sample for generalizations. There is also another version – Conditions for Work Effectiveness Questionnaire I that is considerably longer and detailed. It is meant for use in organizations for improvement initiatives (Laschinger, 2012). It could broadly comprise structural empowerment, but its frequency of use is unknown as well as its actual relevance to the phenomenon. We have not tested our suggestions in an updated version of the CWEQ-like questionnaire. This fact also means that our discussion section is foremost a prompt for other researchers and further discussion.

Our paper was generally concerned with empowerment in a constructive way and did not discuss a major critique of the concept. Our reason for this choice is based on the more optimistic side of empowerment we have encountered in the studied organizations. Respondents talked about specific problems that they encounter. However, they were not commensurable with the critique of increased control due to enhanced autonomy (Hodson, 2001), internal tensions of empowered actors (van Baarle et al., 2019), or empowerment as a tool of neoliberal management (Ivanova & von Scheve, 2019).

## 6 CONCLUSION

This paper discussed tangible and lived situations when empowerment is in play. When speaking about access to information, we substituted abstract strategic goals with the knowledge about processes and operational information. Later, discussion of formal and informal power exposed the different roles of trust, intimate relationships, and impact on the work of others are. Our snippets also showed how power is nested in relationships and the structural features of debated organizations. This kaleidoscopic glance at the empowerment phenomenon hopes to encourage more empirical work with abstract and ephemeral phenomena. Especially when they are so visible in management books, loud in HR conferences, and frequent

in business school courses. Our findings support the argument that empowerment is dynamic and situated in relationships. Thus, a single intervention cannot increase it, and multiple structural features have to change in accordance. Scales, which are currently routinely used for evaluation of the structural empowerment inside organizations, can capture just a fraction of the whole phenomenon of empowerment on the organizational level. Our empirical material also reminds us that trust in its numerous forms is inseparably connected to empowerment.

The preliminary and partial draft of the questionnaire capturing structural empowerment presented in this paper pursues a different route to measuring structural empowerment than CWEQ-II and points out to the importance of individual interpretation but with emphasis on structural features in play.

### **Acknowledgment**

The University of Economics in Prague funded empirical research for this paper as a doctoral research grant number F3/62/2018.

### **References**

- Allen, S., Winston, B. E., Tatone, G. R., & Crowson, H. M. (2018). Exploring a model of servant leadership, empowerment, and commitment in nonprofit organizations. *Nonprofit Management and Leadership*, 29(1), 123-140. doi: 10.1002/nml.21311
- Bartram, T., Karimi, L., Leggat, S. G., & Stanton, P. (2014). Social identification: linking high performance work systems, psychological empowerment and patient care. *The International Journal of Human Resource Management*, 25(17), 2401-2419. doi: 10.1080/09585192.2014.880152
- Bartunek, J. M., & Spreitzer, G. M. (2006). The interdisciplinary career of a popular construct used in management: Empowerment in the late 20th century. *Journal of Management Inquiry*, 15(3), 255-273. doi: 10.1177/1056492606291201
- Berraies, S., Chaher, M., & Ben Yahia, K. (2014). Employee Empowerment and Its Importance for Trust, Innovation and Organizational Performance. *Business Management and Strategy*, 5(2), 82-103. doi: 10.5296/bms.v5i2.6558
- Biron, M., & Bamberger, P. (2010). The impact of structural empowerment on individual well-being and performance: Taking agent preferences, self-efficacy and operational constraints into account. *Human Relations*, 63(2), 163-191. doi: 10.1177/0018726709337039
- Brummans, B. H. J. M. (2018). *The Agency of Organizing. Perspectives and Case Studies*. New York: Routledge.
- Burke, W. (1986). Leadership as empowering others. *Executive power*, 51-77. Retrieved from [https://www.researchgate.net/profile/W\\_Burke/publication/246661498\\_Leadership\\_as\\_Empowering\\_Others/links/56aa400608aeab4cefaf595.pdf](https://www.researchgate.net/profile/W_Burke/publication/246661498_Leadership_as_Empowering_Others/links/56aa400608aeab4cefaf595.pdf)
- Çekmecelioglu, H. G., & Özbağ, G. K. (2016). Psychological empowerment and support for innovation in Turkish manufacturing industry: Relations with individual creativity and firm innovativeness. *Journal for East European Management Studies*, 21(1), 10-34. doi: 10.1688/JEEMS-2016-Cekmecelioglu

- Conger, J. A., & Kanungo, R. N. (1988). The Empowerment Process: Integrating Theory and Practice. *Academy of Management Review*, 13(3), 471-482. doi: 10.5465/amr.1988.4306983
- Drucker, P. F. (2018). *The essential Drucker: selections from the management works of Peter F. Drucker*. Abingdon: Routledge.
- Ergeneli, A., Ari, G. S., & Metin, S. (2007). Psychological empowerment and its relationship to trust in immediate managers. *Journal of business research*, 60(1), 41-49. doi: 10.1016/j.jbusres.2006.09.012
- Eylon, D. (1998). Understanding empowerment and resolving its paradox: Lessons from Mary Parker Follet. *Journal of Management History*, 4(1), 16-28. doi: 10.1108/13552529810203905
- Fleming, P., & Spicer, A. (2008). Beyond power and resistance - New approaches to organizational politics. *Management Communication Quarterly*, 21(3), 301-309. doi: 10.1177/0893318907309928
- Gagné, M., Senécal, C. B., & Koestner, R. (1997). Proximal Job Characteristics, Feelings of Empowerment, and Intrinsic Motivation: A Multidimensional Model. *Journal of Applied Social Psychology*, 27(14), 1222-1240. doi: 10.1111/j.1559-1816.1997.tb01803.x
- Gregory, B. T., Albritton, M. D., & Osmonbekov, T. (2010). The Mediating Role of Psychological Empowerment on the Relationships between P-O Fit, Job Satisfaction, and In-role Performance. *Journal of Business and Psychology*, 25(4), 639-647. doi: 10.1007/s10869-010-9156-7
- Hardy, C., Phillips, N., & Lawrence, T. (1998). Distinguishing trust and power in interorganizational relations: Forms and facades of trust. In C. Lane & R. Bachmann (Eds.), *Trust Within and Between Organizations*. Oxford: Oxford University Press.
- Harley, B. (1999). The myth of empowerment: work organisation, hierarchy and employee autonomy in contemporary Australian workplaces. *Work, Employment and Society*, 13(1), 41-66. doi: 10.1177/09500179922117782
- Hodson, R. (2001). *Dignity at work*. Cambridge: Cambridge University Press.
- Hon, A. H., & Rensvold, R. B. (2006). An interactional perspective on perceived empowerment: the role of personal needs and task context. *The International Journal of Human Resource Management*, 17(5), 959-982. doi: 10.1080/09585190600641271
- Ivanova, M., & von Scheve, C. (2019). Power through empowerment? The managerial discourse on employee empowerment. *Organization*. doi: 10.1177/1350508419855709
- Jaffery, H. & Farooq, H. (2015). The Impact of Structural Empowerment on Organizational Citizenship Behavior-Organization and Job Performance: A Mediating Role of Burnout. *Journal of Management Sciences*, 2(2), 274-289. doi: 10.20547/jms.2014.1502204
- Jo, S. J., & Park, S. (2016). Critical review on power in organization: Empowerment in human resource development. *European Journal of Training and Development*, 40(6), 390-406. doi: 10.1108/EJTD-01-2016-0005
- Kanter, R. M. (1993). *Men and Women of the Corporation*. New York: Basic Books.
- Kaya, Ç., & Altınkurt, Y. (2018). Öğretmenlerin Psikolojik Sermayeleri ile Tükenmişlik Düzeyleri Arasındaki İlişkide Psikolojik ve Yapısal Güçlendirmenin Rolü. *Education and Science*, 43(193), 63-78. doi: 10.15390/EB.2018.6961

- Knol, J., & Van Linge, R. (2009). Innovative behaviour: The effect of structural and psychological empowerment on nurses. *Journal of Advanced Nursing*, 65(2), 359-370. doi: 10.1111/j.1365-2648.2008.04876.x
- Kuokkanen, L., Leino-Kilpi, H., Katajisto, J., Heponiemi, T., Sinervo, T., & Elovainio, M. (2014). Does Organizational Justice Predict Empowerment? Nurses Assess Their Work Environment. *Journal of Nursing Scholarship*, 46(5), 349-356. doi: 10.1111/jnu.12091
- Laschinger, H. K. S., Finegan, J., Shamian, J., & Wilk, P. (2001). Impact of structural and psychological empowerment on job strain in nursing work settings: expanding Kanter's model. *Journal of nursing Administration*, 31(5), 260-272. doi: 10.1097/00005110-200105000-00006
- Laschinger, H. K. S. (2012). *CWEQ - Conditions for Work Effectiveness: Questionnaire I and II - Conceptual Framework for Tool*. Canada: Western University. Retrieved from <https://www.uwo.ca/fhs/hkl/cweq.html>
- Liden, R. C., Wayne, S. J., & Sparrowe, R. T. (2000). An examination of the mediating role of psychological empowerment on the relations between the job, interpersonal relationships, and work outcomes. *Journal of applied psychology*, 85(3), 407-416. doi: 10.1037/0021-9010.85.3.407
- Lincoln, N. D., Travers, C., Ackers, P., & Wilkinson, A. (2002). The meaning of empowerment: the interdisciplinary etymology of a new management concept. *International Journal of Management Reviews*, 4(3), 271-290. doi: 10.1111/1468-2370.00087
- Magee, J. C., & Galinsky, A. D. (2008). 8 Social Hierarchy: The Self-Reinforcing Nature of Power and Status. *Academy of Management Annals*, 2(1), 351-398. doi: 10.1080/19416520802211628
- Maynard, M. T., Gilson, L. L., & Mathieu, J. E. (2012). Empowerment – Fad or Fab? A Multilevel Review of the Past Two Decades of Research. *Journal of Management*, 38(4), 1231-1281. doi: 10.1177/0149206312438773
- Orgambidez-Ramos, A., & Borrego-Alés, Y. (2014). Empowering employees: Structural empowerment as antecedent of job satisfaction in university settings. *Psychological Thought*, 7(1), 28-36. doi: 10.5964/psyct.v7i1.88
- Randolph, W. A. (1995). Navigating the journey to empowerment. *Organizational dynamics*, 23(4), 19-32. doi: 10.1016/0090-2616(95)90014-4
- Robbins, T. L., Crino, M. D., & Fredendall, L. D. (2002). An integrative model of the empowerment process. *Human resource management review*, 12(3), 419-443. doi: 10.1016/S1053-4822(02)00068-2
- Schnackenberg, A. K., & Tomlinson, E. C. (2016). Organizational transparency: A new perspective on managing trust in organization-stakeholder relationships. *Journal of Management*, 42(7), 1784-1810. doi: 10.1177/0149206314525202
- Seibert, S.E., Silver, S.R. and Randolph, W.A. (2004). Taking empowerment to the next level, a multiple-level model of empowerment, performance, and satisfaction. *Academy of Management Journal*, 47(3), 332-349. doi: 10.5465/20159585
- Seibert, S. E., Wang, G., & Courtright, S. H. (2011). Antecedents and Consequences of Psychological and Team Empowerment in Organizations: A Meta-Analytic Review. *Journal of Applied Psychology*, 96(5), 981-1003. doi: 10.1037/a0022676

- Spreitzer, G. M. (1995). Psychological empowerment in the workplace: dimensions, measurement, and validation. *Academy of Management Journal*, 38(5), 1442-1465. doi: 10.5465/256865
- Spreitzer, G. M. (2008). Taking stock: A review of more than twenty years of research on empowerment at work. In J. Barling & C. L. Cooper (Eds.), *The SAGE Handbook of Organizational Behavior: Volume One: Micro Approaches*. London: SAGE.
- Staw, B. M., & Epstein, L. D. (2000). What Bandwagons Bring: Effects of Popular Management Techniques on Corporate Performance, Reputation, and CEO Pay. *Administrative Science Quarterly*, 45(3), 523-556. doi: 10.2307/2667108
- Tuuli, M. M., Rowlinson, S., Fellows, R., & Liu, A. M. (2012). Empowering the project team: impact of leadership style and team context. *Team Performance Management: An International Journal*, 18(3/4), 149-175. doi: 10.1108/13527591211241006
- van Baarle, S., Dolmans, S. A., Bobelyn, A. S., & Romme, A. G. L. (2019). Beyond Command and Control: Tensions Arising From Empowerment Initiatives. *Organization Studies*, 1-23. doi: 10.1177/0170840618818600
- van Bogaert, P., Peremans, L., Diltour, N., Van Heusden, D., Dilles, T., Van Rompaey, B., & Havens, D. S. (2016). Staff nurses' perceptions and experiences about structural empowerment: A qualitative phenomenological study. *PLoS One*, 11(4), e0152654. doi: 10.1371/journal.pone.0152654
- Yao, Q., Chen, R., & Cai, G. (2013). How internal marketing can cultivate psychological empowerment and enhance employee performance. *Social Behavior and Personality*, 41(4), 529-538. doi: 10.2224/sbp.2013.41.4.529
- Yildirim, F., & Naktiyok, S. (2017). The Mediating role of organizational support in the effect of transformational leadership on employee empowerment. *Polish Journal of Management Studies*, 16(1), 292-303. doi: 10.17512/pjms.2017.16.1.25

## Contact information

### **Mgr. Ivana Lukeš Rybanská**

University of Economics in Prague, Faculty of Business Administration  
 W. Churchill Sq. 1938/4, 13067, Prague 3, Czech Republic  
 E-mail: ivana.rybanska@vse.cz  
 ORCID: 0000-0003-1183-4249

### **Ing. Mgr. Šárka Nováková**

University of Economics in Prague, Faculty of Business Administration  
 W. Churchill Sq. 1938/4, 13067, Prague 3, Czech Republic  
 E-mail: sarka.novakova@vse.cz  
 ORCID: 0000-0002-7465-4790

doi: 10.7441/dokbat.2019.063

# ANALYSIS OF THE INTERACTIONS OF SOCIAL NETWORK USERS IN CENTRAL SLOVAKIA BASED ON THE TIMING OF COMMUNICATION

*Barbora Marišová, František Olšavský, Eva Smolková, Lukáš Val'ko*

## Abstract

New technology is developed regularly year by year and affects the majority of business sectors. Integration of such technological tools into practice vary depending on its character, as well as on the character of the specific sector. Social media is a kind of such technological trend, which appeared several years ago and in recent past it became a businesses' vital communication channel. A goal of this paper is to analyse the interactions of a selected social network (Facebook) users to posts of 4 selected regional destination management organizations (RDMOs) in central Slovakia. Data were collected by analysis of each post posted by chosen regional destination management organizations in Central Slovakia during the chosen period (summer season). Using descriptive statistics and a Kruskal-Wallis Test we inquired, whether there exists a significant influence of a weekday when posts were published on RDMOs followers' interactions. Then we evaluated, which content had the highest interaction on which weekday. Results showed that there actually exists a significant influence between a weekday and a success rate of the RDMOs' Facebook posts. The content of the most successful posts was identified and based on the results, several practical recommendations were developed for the RDMOs in order to increase their social media attractiveness.

**Keywords:** *destination management organization, destination marketing, Facebook, social media*

## 1 INTRODUCTION

Tourism is a sector whose growth has been undisputed in recent years. Many factors have influenced the dynamics of tourism development, but the most important ones are modern technologies. Technology has made it possible for many marketing intermediaries, specific service providers, who have made tourism products accessible to individuals and less wealthy groups, and, last but not least, have played the role in social networks communication. The article focuses primarily on social networks, those technologies that millions of people use today to find information about the offer of tourism products anywhere in the world. Social networks are now used by all tourism entities, but also by regional tourism organizations or clusters of tourism entities.

Social networks allow the candidate to grasp a comprehensive offer of destination management. They are currently used by the most famous destinations in the world but also by those that were unknown or could not be visualized by means of classical communication tools. Providing relevant and up-to-date information about a particular tourist destination is now standard in the world and anyone who does not use modern communication technologies is almost invisible to tourists. Placing information in a specific social media with selected content so that the information reaches as many people as possible requires an understanding of the decision-making process for traveling and tourist behaviour during holiday or other activities. The information must have relevant content and be expediently timed to reach as many users as possible. However, each social network has its own specifics, so it is necessary to analyse who, when, why and what information seeks, who shares it and who becomes a participant in tourism.



In other words, information needs to be selected and adapted to the needs of users of a particular network.

The aim of the paper is to analyse the interactions of social network users in Central Slovakia with respect to individual content, as well as the timing of the publication of information that destination marketing workers place on social networks.

## **2 LITERATURE REVIEW**

### **2.1 Destination Marketing**

Tourism is a complex system formed by two subsystems, namely object of tourism (supply side) and subject of tourism (demand side) (Hesková et al., 2011). In this complex system, it is a destination with its services and attractions that plays a key role on the supply side with destination management organization (DMO) as an intermediary between supply side and demand side (Kotler et al., 2017).

One of the main tasks of DMO is destination marketing (Pearce, 2015; Morrison, 2019) which nowadays has a key role when it comes to future growth and sustainability of tourism destinations in still more competitive and globalized market (UNWTO, 2011). This is proved also by findings from research realized by Bornhorst, Brent Ritchie and Sheehan (2010) about determinants of tourism success for DMOs and destinations when effective marketing was considered as very important tool for destination success achievement. Competitive advantage of DMO comparing to individual tourism actors (such as hotels, restaurants, attraction providers etc.) is that thanks to numerous DMO's partnerships and gathered finance, for DMO it is much easier to promote destination in more distant and wider markets (Wang & Pizam, 2011).

Unlike years ago, when mainly advertisement through TV, radio or billboards were used, nowadays thanks to the Internet, different communication tools are available, such as websites (Li, Robinson & Oriade, 2017) or social media (Pike & Page, 2014) which allow DMOs to communicate with their customers about their activity, products' offer as well as destination itself (Buhalis & Law, 2007).

Von Bergner and Lohmann (2013) see use of modern technologies (such as social media and social networks) as one of the biggest future challenges for DMOs as they have to adapt their initiatives and tactics in order to fulfil tourists' needs and wishes.

### **2.2 Social Media Communication in Destination Marketing**

Boyd and Ellison (2007) explain social media as internet services enabling individuals to create public profiles in a bounded system, publish their other connections and contact lists and link these contact lists with other ones within the system.

While some, mainly older publications, link social media only as a tool for personal purposes, other authors start to mind social media's importance in business as well. American authors Mangold and Faulds (2009) see social media and social networks as a vital part of digital marketing. Digital marketing, online marketing or e-marketing is a new interconnection between marketing and internet world. Its main role is to use communication and promotion tools in a digital space.

Originally not meant that way, however, in the recent past social media have become a new and vital marketing tool for businesses (Reshma, 2019). The social media trend and the most popular social networks by the number of users worldwide are visible on Figure 1.

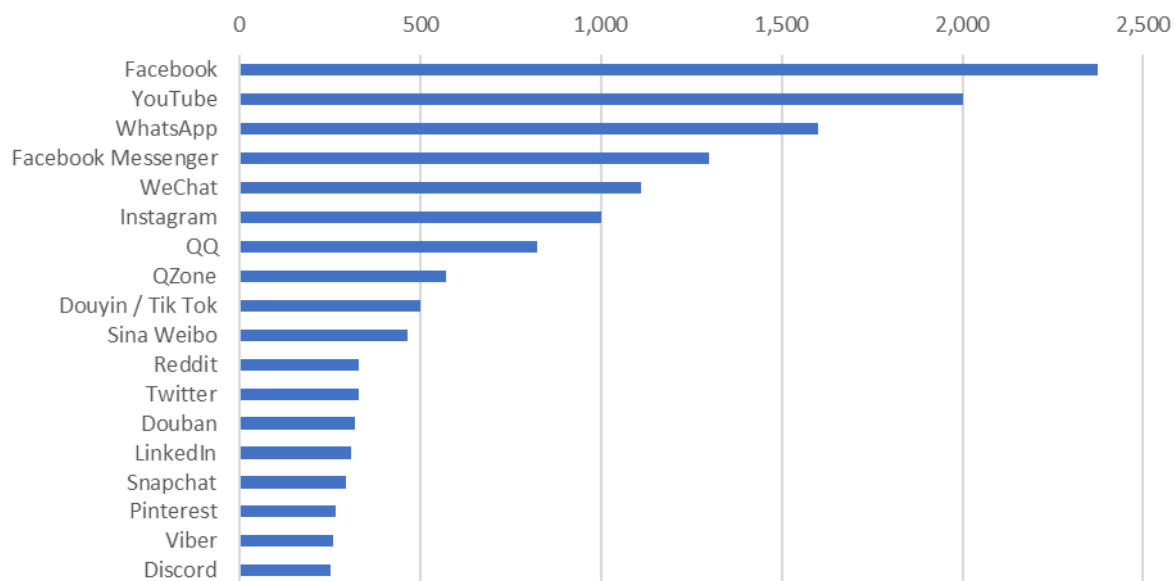

Fig. 1 – The most popular social networks and applications for instant communication. Source: Clement (2019)

Tourism is a specific business sector, as a lot of factors affect its development and also a current state in particular destination. Therefore, it has to be dynamic and flexible and quickly react to high number of different circumstances. And thus, the same marketing tool was needed to help with its promotion – social media.

The importance of social media in tourism has been noted and researched as an emerging topic. It plays an increasingly important role in many aspects of tourism, especially in searching for information, making the decisions (Zeng, 2013) or the core tourism promotion (Fotis, Buhalis & Rossides, 2012).

However, Edwards (2011) points out also the possible negative effects of communication through social media. They can impact communication either positively or negatively depending on the subjects under study and the type of communication. Social media requires an integration of all marketing activities and persuasive advertising to provide a competitive customer experience.

Živković, Gajic and Brdar (2014) emphasize the importance of social media in tourism and explain it as an important tool for the analysis of tourists' attitudes. This is confirmed by the increased purchases and recommendations to other users. Building successful service-based brand in tourism means that each other should be a unique value proposition based on the customer experience. The key is to create expectations of what can be found at destination and to reduce uncertainty (Wilson et al., 2006).

Above all, Facebook has a huge influence on consumer choices globally, especially in the travel sector. The research from 2012 has shown that 76% of tourists post photos from holidays on Facebook and 40% post activity/attraction reviews. The importance of reviews and word-of-mouth marketing was proved by numbers as well. More than 90% of consumers from all over the world say they trust recommendations from friends and only 48% of all the travellers who used social media to create travel plans, stuck with their original travel plans (Litvin, Goldsmith & Pan, 2008).

Digital technologies have contributed to fundamental changes in the tourism industry in general and also in destination marketing and determined a better understanding of the decision-making process of the travel, tourists' behaviour during vacation and post vacation activities. And every year, new technology and social media are being introduced to increase tourism's potential.

### 3 METHODOLOGY

The main objective of this paper is to analyse the interactions of a selected social network (Facebook) users to posts of 4 selected regional destination management organizations (RDMOs) in central Slovakia. We focused on influence of content and timing of posts to final interaction. Data for this research were gained through consistent analysis of each Facebook post posted by RDMOs (Region Horehronie, Region Liptov, Stredné Slovensko, Turistický Novohrad a Podpoľanie) on their Facebook fan pages in the period between June 1, 2019 and August 31, 2019. The choice of this time period was targeted, as the destinations in which examined RDMOs operate are the summer season destinations.

These variables were considered by each post within the period: **(a) content of a post** – what was the post telling about, we categorized each post to one of the following categories: news, information about RDMO, events, destination photos, promotion of RDMO’s members, tips for trips, promotion of RDMO’s products, call for interaction/competition or other; **(b) interactions with a post** – sum of likes, comments and shares of posts; and **(c) weekday**, which the RDMOs posted their Facebook posts on.

Besides simple descriptive statistics (MS Excel Pivot Tables) for calculating the results, we as well used a Kruskal–Wallis Test (IBM SPSS Statistics). We decided to use Kruskal–Wallis Test to identify whether the timing of posts has an impact on an average followers’ interaction.

### 4 RESULTS

#### 4.1 Posts and followers’ interactions by weekdays

Research results showed the following split of Facebook posts during weekdays (see Fig. 2). The most of posts were posted on Friday (135 posts out of 691 posts). Second most favourite day (by RDMOs) for posting was Wednesday (119 posts) followed by Thursday (108 posts). There were 103 posts posted on Monday as well as on Tuesday. On Saturday only 66 posts were posted while on Sunday there were only 57 posts.

However, when it comes to average followers’ interactions, the order of weekdays looked differently. Unlike posts’ split during weekdays when Sunday proved to be the least used, when it comes to days during which followers showed the highest rate of interaction, Sunday was the number one (average followers’ interactions: 84). The second day with highest followers’ interaction rate was Thursday (70) followed by Monday (67), Friday (59) and Wednesday (57). The lowest number of average followers’ interaction was on Saturday (47) and Tuesday (42).

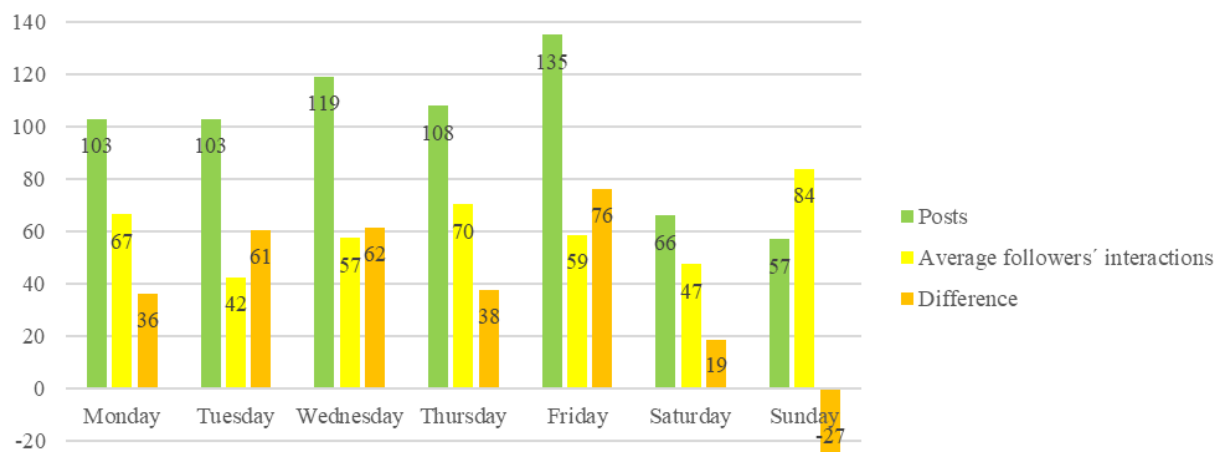

Fig. 2 – Split of posts among weekdays and average followers’ interactions. Source: own research

Results showed that there exist differences (Fig. 2 – “Difference”) between the most popular days for posting among RDMOs (2 – “Posts”) and days during which followers interact the most (Fig. 2 – “Average followers’ interactions”). However, important is to identify whether the different posting day has a significant influence on an average followers’ interaction.

We used simple Kruskal-Wallis test to identify, whether a specific weekday has a significant influence on average followers’ interaction. In other words, we tried to identify, whether followers’ activity on social media (at Facebook fan pages of 4 subjected RDMOs: Liptov, Horehronie, Central Slovakia, Turistický Novohrad a Podpoľanie) differs depending on a current weekday.

Data gained directly from their Facebook fan pages were split into 7 categories (from Monday to Sunday) and taken into consideration together as a whole to get more relevant statistical results.

Fig. 3 shows the IBM SPSS report of the Kruskal-Wallis test. Altogether, we managed to record 691 unique Facebook posts with a mean of 60 interaction per post.

With confidence interval 95%, when  $\alpha = 0.05$ , the p-value (0.007) of this case was much lower than the  $\alpha$ -value. Thus, we could reject the H0 hypothesis telling that there’s no influence of a weekday on an average RDMOs’ Facebook post interaction. Therefore, we accepted the H1 hypothesis and confirmed that an actual weekday has a strong influence on the followers’ interactions. This result statistically confirmed previous calculations.

**Descriptive Statistics**

	N	Mean	Std. Deviation	Minimum	Maximum
V21	691	60,03	99,849	0	1364
V5	691	3,72	1,831	1	7

**Kruskal-Wallis Test**

**Ranks**

	V5	N	Mean Rank
V21	1	103	374,25
	2	103	305,25
	3	119	340,06
	4	108	354,08
	5	135	325,11
	6	66	335,57
	7	57	427,22
Total		691	

**Test Statistics<sup>a,b</sup>**

V21	
Chi-Square	17,738
df	6
Asymp. Sig.	,007

a. Kruskal Wallis Test  
b. Grouping Variable: V5

Fig. 3 – Kruskal-Wallis test of weekday’s influence on followers’ interaction. Source: own research

Due to the fact, that weekday’s influence on average followers’ interaction was identified as well as differences between the most popular days for posting among RDMOs and days during which followers interact the most, we searched for potential room for improvement. Therefore,

we identified the weekdays during which the highest difference between number of posts and average number of followers' interactions showed up (see Fig. 4).

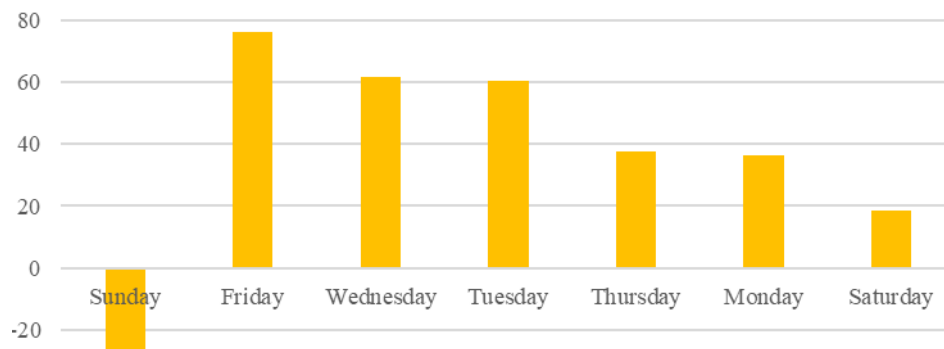

Fig. 4 – Difference between number of posts and average number of interactions. Source: own research

High potential for improvement was identified for Sunday. RDMOs posted only 57 posts on Sunday while the average followers' interaction rate was very high (84 interactions), but we have to take into consideration the fact that Sunday is a weekend day.

Unlike Sunday, where potential for more posts was identified, it seems to be useless to post so many posts on Friday (135 posts) since the average followers' interaction rate was only 59, Wednesday (119 posts) with 57 interactions per post and Tuesday (103 posts) with 42 interactions per post. On the contrary, it seems to be effective to continue with adding posts on Thursday and Monday (average followers' interaction rate was high: 70 interactions per post for Thursday and 67 interactions per post for Monday as well as low difference between number of posts and average number of followers' interactions was identified). Regarding Saturday, not many interactions per post were identified but also the number of posts was low. Therefore, changes in posting on Saturday do not seem to be necessary.

#### 4.2 What content on which weekday?

It was proved that weekday on which post was posted has an influence on average followers' interaction and the timing of posts is the vital factor of their success. However, what content should RDMOs post during the specific weekday? Looking at two dimensions – 1) weekday and 2) post's content and corresponding average number of interactions, we have identified TOP 10 combinations of content and weekday with highest rate of average followers' interaction among researched variations. TOP 1 regarding the average number of followers' interaction gained news posted on Thursday (230 interactions). Second highest rate of average followers' interaction reached destination photos posted on Monday (205 interactions). Third place reached destination photos posted on Friday (185 interactions) followed by news posted on Sunday (179 interactions). Fifth most interacted were tips for trips added on Wednesday (177 interactions). Number 6 among TOP 10 reached destination photos posted on Tuesday (175 interactions) and number 7 were tips for trips posted on Saturday (173 interactions). Eighth highest rate of average followers' interaction gained destination photos which were added on Facebook on Sunday (172 interactions) followed by news added on Friday (167 interactions). Last place from TOP 10 reached destination photos posted on Thursday (155 interactions). Average posts interactions' by content and weekday shows Fig. 5

According to these findings (see also Fig. 5), a recommended content of posts for each weekday was identified.

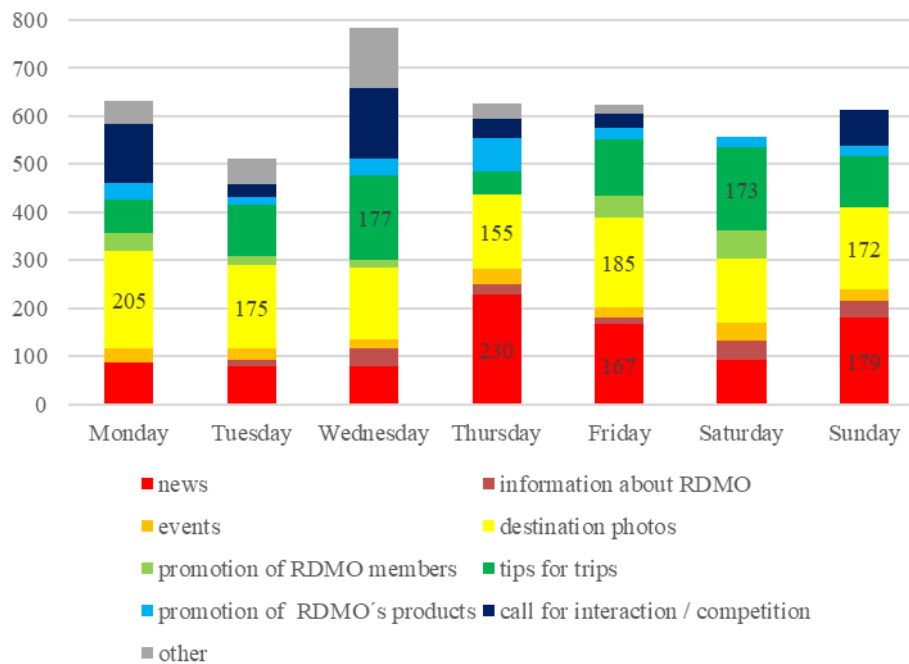

Fig. 5 – Average posts interactions' by content and weekday. Source: own research

On Monday RDMOs should focus on posting destination photos (order of another content types according to average followers' interaction on Monday: 2. call for interaction / competition, 3. news, 4. tips for trips, 5. other, 6. promotion of RDMO's products, 7. promotion of RDMO's members, 8. events and 9. information about RDMO).

On Tuesday RDMOs should add posts with destination photos (order of another content types according to average followers' interaction on Tuesday: 2. tips for trips, 3. news, 4. other, 5. call for interaction / competition, 6. events, 7. promotion of RDMO's members, 8. promotion of RDMO's products and 9. information about RDMO).

For Wednesday tips for trips are mainly recommended (order of another content types according to average followers' interaction on Wednesday: 2. destination photos, 3. call for interaction / competition, 4. other, 5. news, 6. information about RDMO, 7. promotion of RDMO's products, 8. events and 9. promotion of RDMO's members).

On Thursday RDMOs should mainly focus on news and destination photos (order of another content types according to average followers' interaction on Thursday: 3. promotion of RDMO's products, 4. tips for trips, 5. call for interaction / competition, 6. other, 7. events, 8. information about RDMO and 9. promotion of RDMO's members).

For Friday mainly destination photos and news are recommended (order of another content types according to average followers' interaction on Friday: 3. tips for trips, 4. promotion of RDMO's members, 5. call for interaction / competition, 6. promotion of RDMO's products, 7. events, 8. other and 9. information about RDMO).

Regarding Saturday's posts, tips for trips should be number one (order of another content types according to average followers' interaction on Saturday: 2. destination photos, 3. news, 4. promotion of RDMO's members, 5. information about RDMO, 6. events, 7. promotion of RDMO's products, 8. call for interaction / competition and 9. other).

Finally, for Sunday mainly posts with news and destination photos are recommended (order of another content types according to average followers' interaction on Sunday: 3. tips for trips, 4. call for interaction / competition, 5. information about RDMO, 6. events, 7. promotion of RDMO's products, 8. promotion of RDMO's members and 9. other).

## 5 CONCLUSION

In this article we tried to draw attention to the importance of social networks in tourism, especially for destination management entities. Destination marketing is currently playing a very important role in the destination, with social networks as key communication channels. The research carried out in Central Slovakia only confirmed this. Research has shown that the weekday and content of posts is of the utmost importance. By Kruskal-Wallis test we have proved the influence of weekday when a post is posted on average number of followers' interactions. That means that the timing of posts has been shown to be crucial, in relation to the day of the week on which the post is published. Based on these findings, we have identified the most suitable weekdays (Sunday, Thursday, Monday) for posting as well as the potential room for improvement for RDMOs and their social networks activity like posting more on Sunday (if possible) and less on Friday, Wednesday or Tuesday. However, not only right weekday is crucial for posting the posts, the choice of relevant content is important as well. We have identified the best combinations of weekday and content of posts according to followers' interactions, for example it seems to be effective to post news on Thursday, destination photos on Monday or destination photos on Friday. Generally, users appreciate news, destination photos as well as recommendations for trips within the destination. The growth of the number of active users is a clear signal of the effective work of destination management entities on social networks in the selected destinations.

### References

- Bornhorst, T., Brent Ritchie, J. R., & Sheehan, L. (2010). Determinants of tourism success for DMOs & destinations: An empirical examination of stakeholders' perspectives. *Tourism Management*, 31(5), 572-589. doi: 10.1016/j.tourman.2009.06.008
- Boyd, D. M., & Ellison, N. B. (2007). Social Network Sites: Definition, History, and Scholarship. *Journal of Computer-Mediated Communication*, 13(1), 210-230. doi: 10.1111/j.1083-6101.2007.00393.x
- Buhalis, D., & Law, R. (2008). Progress in information technology and tourism management: 20 years on and 10 years after the Internet: The state of eTourism research. *Tourism Management*, 29(4), 609-623. doi: 10.1016/j.tourman.2008.01.005
- Clement, J. (2019). *Global social networks ranked by number of users 2019*. Statista. Retrieved from <https://www.statista.com/statistics/272014/global-social-networks-ranked-by-number-of-users/>
- Edwards, S. (2011). A Social Media Mindset. *Journal of Interactive Advertising*, 12(1), 1-3. doi: 10.1080/15252019.2011.10722186
- Fotis, J., Buhalis, D., & Rossides, N. (2012). Social Media Use and Impact during the Holiday Travel Planning Process. In M. Fuchs et al. (Eds.), *Information and Communication Technologies in Tourism 2012*. Vienna: Springer. doi: 10.1007/978-3-7091-1142-0\_2
- Hesková, M., Beránek, J., Dvořák, V., Novacká, L., & Oriška, J. (2011). *Cestovní ruch*. Praha: Fortuna.
- Kotler, P., Bowen, J. T., Makens, J. C., & Baloglu, S. (2017). *Marketing for Hospitality and Tourism*. Harlow: Pearson Education.
- Li, S. C. H., Robinson, P. a Oriade, A. (2017). Destination marketing: The use of technology since the millennium. *Journal of Destination Marketing & Management*, 6(2), 95-102. doi: 10.1016/j.jdmm.2017.04.008

- Litvin, W. S., Goldsmith R. E. & Pan, B. (2008). Electronic Word of Mouth in Hospitality and Tourism Management. *Tourism Management*, 29(3), 458-468. doi: 10.1016/j.tourman.2007.05.011
- Mangold, W. G., & Faulds, D. J. (2009). Social media: The new hybrid element of the promotion mix. *Business Horizons*, 52(4), 357-365. doi: 10.1016/j.bushor.2009.03.002
- Morrison, A. M. (2019). *Marketing and Managing Tourism Destinations*. Abingdon: Routledge.
- Pearce, D. G. (2015). Destination management in New Zealand: Structures and functions. *Journal of Destination Marketing & Management*, 4(1), 1-12. doi: 10.1016/j.jdmm.2014.12.001
- Pike, S., & Page, S. J. (2014). Destination Marketing Organizations and destination marketing: A narrative analysis of the literature. *Tourism Management*, 41, 202-227. doi: 10.1016/j.tourman.2013.09.009
- Reshma, B. K. (2019). Impact of social media advertisement on consumer's buying decisions. *International Journal in Management and Social Science*, 7(5), 51-60. Retrieved from [https://www.academia.edu/39770598/IMPACT\\_OF\\_SOCIAL\\_MEDIA\\_ADVERTISE\\_MENT\\_ON\\_CONSUMERS\\_BUYING\\_DECISIONS](https://www.academia.edu/39770598/IMPACT_OF_SOCIAL_MEDIA_ADVERTISE_MENT_ON_CONSUMERS_BUYING_DECISIONS)
- UNWTO (2011). *Policy and practice for global tourism*. Madrid: UNWTO.
- Von Bergner, N. M., & Lohmann, M. (2013). Future Challenges for Global Tourism: A Delphi Survey. *Journal of Travel Research*, 53(4), 59-61. doi: 10.1177/0047287513506292
- Wang, Y., & Pizam, A. (2011). *Destination Marketing and Management: Theories and Applications*. Wallingford: CAB International.
- Wilson, A., Zeithaml, V., Bitner, M. J., & Gremler, D. (2006). *Services Marketing: integrating Customer Focus across the Firm*. London: McGraw-Hill.
- Zeng, B. (2013). Social Media in Tourism. *Tourism & Hospitality*, 2(1), Article 125. doi: 10.4172/2167-0269.1000e125
- Živković, R., Gajic, J., & Brdar, I. (2014). The Impact of Social Media on Tourism. *Singidunum Journal of Applied Sciences*, 2014, 758-761. doi: 10.15308/SINTEZA-2014-758-761

## Contact information

### **Mgr. Barbora Marišová**

Comenius University, Faculty of Management  
 Odbojárov 10, P. O. BOX 95, 82005, Bratislava 25, Slovak Republic  
 E-mail: barbora.sucha@fm.uniba.sk  
 ORCID: 0000-0001-6046-4032

### **Mgr. František Olšavský, PhD.**

Comenius University, Faculty of Management  
 Odbojárov 10, P. O. BOX 95, 82005, Bratislava 25, Slovak Republic  
 E-mail: frantisek.olsavsky@fm.uniba.sk  
 ORCID: 0000-0001-7225-8359



**doc. PhDr. Eva Smolková, CSc.**

Comenius University, Faculty of Management  
Odbojárov 10, P. O. BOX 95, 82005, Bratislava 25, Slovak Republic  
E-mail: eva.smolkova@fm.uniba.sk  
ORCID: 0000-0003-1450-8692

**Mgr. Lukáš Vaľko**

Comenius University, Faculty of Management  
Odbojárov 10, P. O. BOX 95, 82005, Bratislava 25, Slovak Republic  
E-mail: lukas.valko@fm.uniba.sk  
ORCID: 0000-0001-6468-6150

doi: 10.7441/dokbat.2019.064

# DISCRETE EVENT SIMULATION OF N-DEEP SHUTTLE BASED STORAGE SYSTEM

*Jakob Marolt, Tone Lerher*

## **Abstract**

The market provides increasingly diverse products. Additionally, it is expected from the retailers to deliver goods in progressively shorter periods. Both actualities influence the merchandise businesses to desire a fast delivery system with high throughput capacity. Efficient intralogistics operations, including well-organized warehouses, contribute a major part to achieving success in retail market. One of the possible solutions to the stated problem is an automated storage and retrieval system (AS/RS). Shuttle-based storage and retrieval system is a special version of AS/RS where order picking is accomplished in each tier by a shuttle vehicle. The shuttle delivers totes to the lift, which acts as I/O point of the automated warehouse system. While the needs of companies differ from one another and the boundaries are predefined with a given layout, there are numerous different warehouse configurations to consider. To obtain a vast majority and analyse their performances, a discrete-event simulation of an SBS/RS was developed. In this paper we present the concepts of an SBS/RS and how they were implemented to a discrete-event simulation, focused on the storage single command cycle (SCC). Furthermore, this paper presents a study case upon which additional analysis was made, by changing kinematic parameters and fill grade factor of the warehouse.

*Keywords:* warehouse, discrete event simulation, AS/RS, SBS/RS

## **1 INTRODUCTION**

Global supply chain trends demand flexible and faster warehouse systems. To achieve these trends, companies tend to invest in automated storage and retrieval systems (AS/RS). There are multiple versions of AS/RS. One of them are shuttle-based storage and retrieval systems (SBS/RS), which are capable of automatically store and retrieve a desirable tote from the warehouse. SBS/RS contain two types of vehicles. Shuttle vehicle, that are tied to each tier of the warehouse and can only move horizontally and lifts, which can only move vertically. The key advantage of SBS/RS compared to classical AS/RS is the simultaneous work of both shuttles and lifts. The combined work of these two vehicles types bust the utilization and performance of the warehouse system.

In total, there are three type of elementary work cycles in automated warehouses: storing – single command cycle (SSC), retrieval – SCC and dual command cycle (DCC). Storing SSC takes a tote and stores it in the warehouse, retrieval SCC only retrieves a tote from the warehouse, while the DCC first stores the input tote and retrieves another tote from the warehouse in one sequence. This paper focuses on the storing SCC.

To store a tote with a SCC the following actions must take place. Firstly, the tote must be placed onto rolling conveyer that is connected to the warehouse lift system. Secondly, the lift loads the tote, elevates it to the desirable tier and unloads it to a shuttle buffer position (Figure 1). As soon as the shuttle vehicle picks up the tote, the lift system starts to work on another task the main decision system provides.

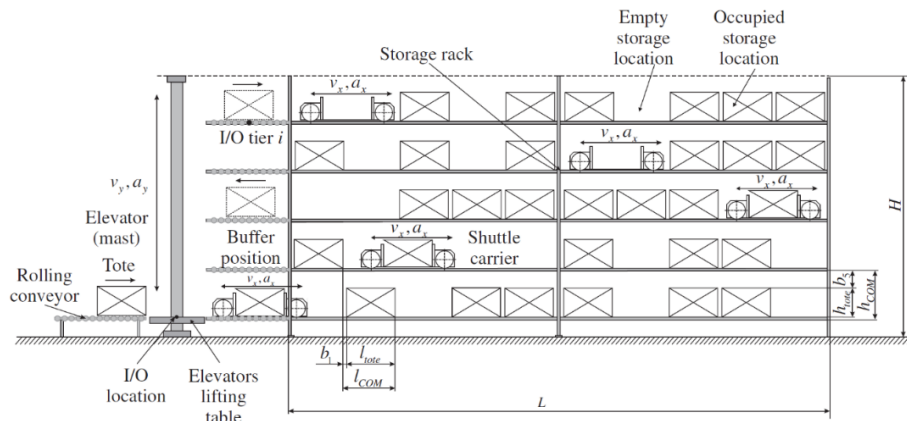

Fig. 1 – Side view of SBS/RS. Source: Lerher et al. (2015)

The tote is taken by the shuttle vehicle and driven in x-direction. Upon arrival to the proper column of the warehouse, the tote must be placed in the deepest possible position by the shuttle vehicle (Figure 2). The shuttle vehicle returns to the idle position which is positioned between the two buffer positions.

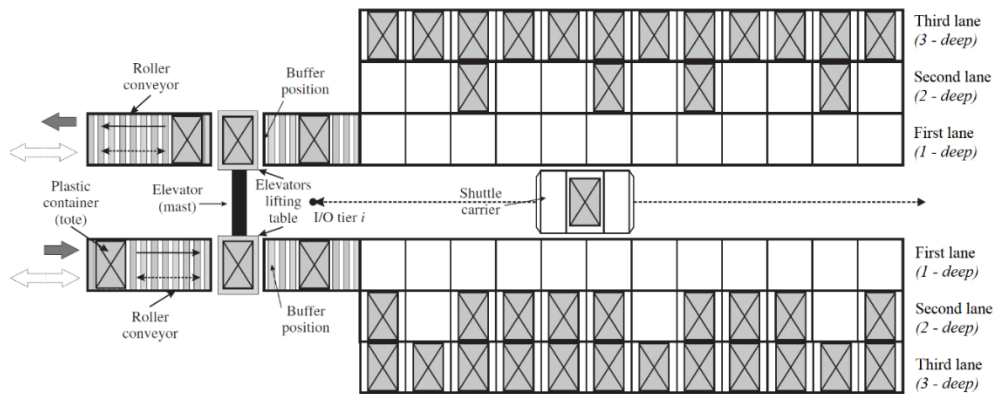

Fig. 2 – Top down perspective of SBS/RS. Source: Lerher et al. (2015)

This paper is organised as follows. In the next section (2), a short literature review is presented. In the chapter Methodology (3), the concept of kinematic behaviour of shuttles and lifts are explained. Additionally, in the next chapter (3) the concepts of discrete event simulation are explained in detail. In chapter (4), a study case is presented with its results. Finally, in the last chapter the whole paper is concluded.

## 2 LITERATURE REVIEW

Potrc et al. (2004) presented the advantages an AS/RS warehouse brought to industry. They studied a 1-deep model with equal sized cells in height and width. They presented the “Strategy X”, where they randomized the storage configurations and calculated the relationship between average travel times and throughput capacity for different types of high storage racks and velocity profiles of storage retrieval machine. They also analysed different command cycles including dual, quadruple and sextuple command cycles. (Potrc et al., 2004)

Lerher et al. (2010) presented new analytical travel time models for the unit-load 2-deep AS/RS. They computed cycle times and evaluated the throughput performance. For the relocation in the retrieval command cycle they applied the nearest free storage heuristics. They determined the expression of the single and dual command cycles from which they evaluated the performance, based on the probability theory and storage rack positions. (Lerher et al., 2010)

Carlo and Vis (2012) considered a new dynamic storage system that was developed by Vanderlande Industries, which is conceptual comparable to SBS/RS this paper is studying. They suggested an integrated look-ahead strategy heuristic to simultaneously assign a set of pre-defined requests to the lifts and the order in which they will be handled. They evaluated how the second lift busted the performance and throughput of the storage system. (Carlo & Vis, 2012)

Lerher et al. (2015) explained in detail the concepts of 2-deep SBS/RS in his paper. He proposed a model considering the real operating characteristics of the lift and shuttle vehicles (Lerher et al., 2015). The process of the totes rearrangement followed the same heuristic rule as described in (Lerher et al., 2010). Lerher et al. (2010) also expressed the calculation of the expected cycle time for single and dual command cycles.

Ning et al. (2016) published a paper that was primarily meant for the warehouse designers to efficiently design rack of multi elevator tier-captive SBS/RS technology. Ning et al. (2016) proposed an auto-remodelled case, for a vast amount of different input parameters. Their simulation contains 81 different rack alternatives, which were simulated under 15 different retrieval rates within 48 hours. Under these considerations they claim that optimal design rack is found out.

While the studied topic is not brand new and scientific literature of automated warehouses covers SBS/RS in depth, we discovered the shortage of papers considering multi (n) deep SBS/RS. Furthermore, the current heuristics and strategy for relocating the totes in SBS/RS are non-existent in the literature. This paper does not investigate the relocation problem of totes, its aim is to describe the process of constructing a discrete event simulation, which we can eventually combine with relocation strategies.

### 3 METHODOLOGY

#### 3.1 Kinematics of lifts and shuttles

All lifts and shuttle were created as separated subclasses of the main class. When the simulation advances time step of the next event lifts and shuttles travel some distance. To define the travelled path, kinematic model was used as was done previously by other authors (Lerher et al., 2015; Carlo & Vis, 2012; Lerher et al., 2010). Both lifts and shuttles in simulation follow the same model. In the model velocity and acceleration parameters are defined. Decelerations are assumed to have the same value as acceleration parameters.

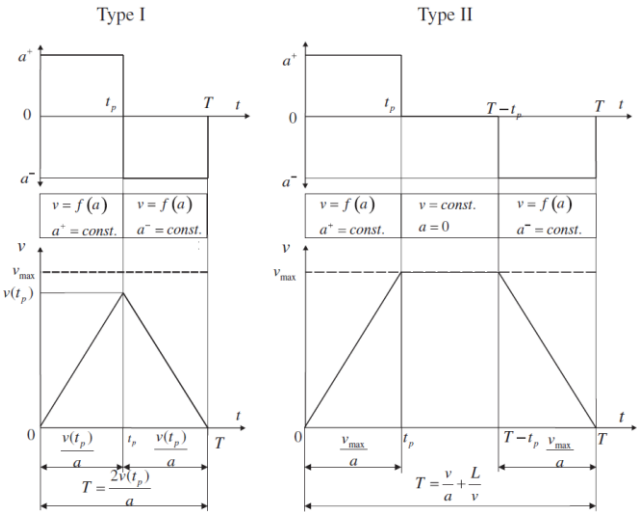

Fig. 3 – Velocity time relationship of SBS/RS shuttles and lifts. Source: Lerher et al. (2010)

The kinematic model is demarcated as one of the two possibilities: type I and type II (Figure 3). Type I possibility states that the vehicle does not reach maximum velocity. Therefore, the velocity time relationship has a characteristic triangle shape. Type II possibility states that the vehicle does reach the maximum velocity. And therefore, the velocity time relationship has a characteristic trapezoid shape. To separate type I from type II, critical path is introduced. Critical path is the distance that is travelled by the vehicle when it reaches the maximum velocity and immediately starts to decelerate afterwards.

The travelled path is the area below the velocity time relationship (Figure 3) and it can be calculated by the well-known kinematics equations. When the critical path is not reached, the path can be evaluated with equation (1):

$$d(T) = \int_0^T v(t)dt = \frac{a \cdot T^2}{4} \tag{1}$$

When the critical path is exceeded the travelled path is evaluated with equation (2):

$$d(T) = \int_0^T v(t)dt = v_{max} \cdot T - \frac{v_{max}^2}{a} \tag{2}$$

**3.2 Discrete-event simulation**

The storage SCC of SBS/RS was simulated with discrete-event simulation (DES). In DES discrete events are calculated and added to the global clock. When there are multiple events happening simultaneously the next discrete event is selected as the minimum of all available. The simulation was modelled with objects orientated programming. In simulation there are four different objects communicating with each other. The main object is named Warehosue. To create it, number of tiers, columns, depth and fill grade factor must be specified. These parameters define the structural configuration of the warehouse, additionally they define the number of empty slots and consequently the fullness of the warehouse. Class Warehouse also calls other three objects: lifts, shuttles and tasks. Objects lifts and shuttles are programmed very similarly as described in chapter 3.1. The key difference is that shuttles are travelling in 2D (columns and depth), while lifts only travel in 1D (tiers). When created, every shuttle generates left and right buffer which corresponds to buffer position in Figure 2. The totes stored in this buffer are either waiting for shuttles, if they are being stored, or lifts, if they are being retrieved or relocated. Every lift when created, generates one roller conveyor, where totes are waiting in queue for the lift.

The final class in the simulation was designed to handle tasks. Each task can be interpreted as a tote or a box. In general, every task has to travel through the following subsystems: lift buffer, lift table, shuttle buffer, shuttle and warehouse (Figure 4). When the task is created for the storing single command cycle, a predefine goal position is attached to the task as an attribute. Predefine goal is calculated with a special method that returns the position of the shortest travel time cell that is also empty. With the attached attribute every subclass can get information about the task predefined goal position and each subpart of the simulation knows where it has to travel to reach the destination.

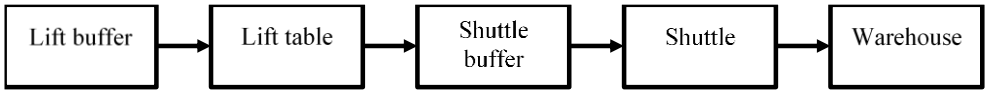

Fig. 4 – Tasks process flow diagram of a storage single command cycle. Source: own research

The whole solution loop of the DES is conceptualized in Figure 5. In the first step of the DES we create object warehouse, shuttles and lifts. Warehouse object requires four variables: depth

of the warehouse, number of tiers of the warehouse, number of columns and feel grade factor alpha. The result of this class is a 3D matrix with randomized elements based on described parameters. Classes *create\_shuttles()* and *create\_lifts()* defines, as names suggest, shuttles and lifts. These two classes are defined with a maximum velocity parameter and acceleration parameter. In the next step task objects are created with method *create\_task\_scc\_storage()*.

After all necessary objects are established the DES can be run. Method *advance\_time()* finds next event amongst all events of initialized objects. Variable *time\_step* is calculated and inserted into a method *add\_time()*. While-true loop iterates for as long as time of next event is not equal to infinity. Upon completion of the loop all tasks are moved from the first subsystem – lift buffer to the last subsystem – warehouse. The list *results* gathers the time information from all of the trials with the same input parameters. The end result calculated as a mean value.

```

1  for j in range(trials):
2      case_study = Warehouse(depth, tiers, columns, alfa)
3      case_study.create_shuttles(vx, ax)
4      case_study.create_lifts(vy, ay)
5
6      for i in range(number_of_tasks):
7          case_study.create_task_scc_storage()
8
9          while case_study.t_event != float("inf"):
10             case_study.advance_time()
11             time_step = case_study.t_event - case_study.clock
12             case_study.add_time(time_step)
13
14             results.append(case_study.clock)
15
16 resultat = mean(results)

```

Fig. 5 – Pseudo code of discrete-event simulation main loop. Source: own research

## 4 STUDY CASE RESULTS

DES of SBS/RS was programmed in Python version 3.6 with the following libraries: numpy, random, math and statistics. The simulation was run on PC with 16 GB of RAM and Intel Xeon E-5 processor with 3.20 GHz.

The goal of this study case was to evaluate the throughput of a specific predefined warehouse. This was done by creating many random cases with the same input parameters and assessed the average time it took to store 50 totes. The modelled study case contained a 3-deep warehouse with 5 tiers and 10 columns. Because one SBS/RS operates with left and right side of the warehouse, there were in total 300 available slots in the warehouse. Each cell in the warehouse was 1 meter wide and 1 meter tall.

The fill-grade factor  $\alpha$  was ranging from 20%, 40%, 60% and 80%. The parameters of shuttles and lift kinematics parameters was set to 1.5 m/s and 3.0 m/s for maximum velocity and 1.5 m/s<sup>2</sup> and 3.0 m/s<sup>2</sup> for the acceleration. In the Table 1 the results of the simulation are presented. Each of the results written in the table below is an average of 1000 iterations.

Tab. 1 – Simulation results. Source: own research

#	$a_y$ [m/s <sup>2</sup> ]	$v_y$ [m/s]	$a_x$ [m/s <sup>2</sup> ]	$v_x$ [m/s]	$\alpha$ [ ]	$t$ [s]	$\lambda$ [min <sup>-1</sup> ]
1.	1.5	1.5	1.5	1.5	20%	515.3	5.82
2.	3.0	1.5	1.5	1.5	20%	489.1	6.13
3.	1.5	3.0	1.5	1.5	20%	519.7	5.77
4.	3.0	3.0	1.5	1.5	20%	462.5	6.49
5.	1.5	1.5	3.0	1.5	20%	515.2	5.82
6.	3.0	1.5	3.0	1.5	20%	479.6	6.26
7.	1.5	3.0	3.0	1.5	20%	508.2	5.90
8.	3.0	3.0	3.0	1.5	20%	462.5	6.49

9.	1.5	1.5	1.5	3.0	20%	517.6	5.80
10.	3.0	1.5	1.5	3.0	20%	491.6	6.10
11.	1.5	3.0	1.5	3.0	20%	510.5	5.88
12.	3.0	3.0	1.5	3.0	20%	463.5	6.47
13.	1.5	1.5	3.0	3.0	20%	516.6	5.81
14.	3.0	1.5	3.0	3.0	20%	479.7	6.25
15.	1.5	3.0	3.0	3.0	20%	514.6	5.83
16.	3.0	3.0	3.0	3.0	20%	455.0	6.59
	<b>a<sub>y</sub></b> [m/s <sup>2</sup> ]	<b>v<sub>y</sub></b> [m/s]	<b>a<sub>x</sub></b> [m/s <sup>2</sup> ]	<b>v<sub>x</sub></b> [m/s]	<b>α</b> [ ]	<b>t</b> [s]	<b>λ</b> [min <sup>-1</sup> ]
1.	1.5	1.5	1.5	1.5	40%	514.9	5.83
2.	3.0	1.5	1.5	1.5	40%	485.5	6.18
3.	1.5	3.0	1.5	1.5	40%	510.3	5.88
4.	3.0	3.0	1.5	1.5	40%	467.7	6.41
5.	1.5	1.5	3.0	1.5	40%	514.3	5.83
6.	3.0	1.5	3.0	1.5	40%	484.2	6.20
7.	1.5	3.0	3.0	1.5	40%	508.4	5.90
8.	3.0	3.0	3.0	1.5	40%	467.0	6.42
9.	1.5	1.5	1.5	3.0	40%	502.1	5.97
10.	3.0	1.5	1.5	3.0	40%	467.6	6.42
11.	1.5	3.0	1.5	3.0	40%	497.3	6.03
12.	3.0	3.0	1.5	3.0	40%	450.4	6.66
13.	1.5	1.5	3.0	3.0	40%	492.7	6.09
14.	3.0	1.5	3.0	3.0	40%	459.0	6.54
15.	1.5	3.0	3.0	3.0	40%	490.7	6.11
16.	3.0	3.0	3.0	3.0	40%	448.1	6.69
	<b>a<sub>y</sub></b> [m/s <sup>2</sup> ]	<b>v<sub>y</sub></b> [m/s]	<b>a<sub>x</sub></b> [m/s <sup>2</sup> ]	<b>v<sub>x</sub></b> [m/s]	<b>α</b> [ ]	<b>t</b> [s]	<b>λ</b> [min <sup>-1</sup> ]
1.	1.5	1.5	1.5	1.5	60%	501.9	5.98
2.	3.0	1.5	1.5	1.5	60%	473.8	6.33
3.	1.5	3.0	1.5	1.5	60%	493.6	6.08
4.	3.0	3.0	1.5	1.5	60%	456.7	6.57
5.	1.5	1.5	3.0	1.5	60%	500.9	5.99
6.	3.0	1.5	3.0	1.5	60%	472.2	6.35
7.	1.5	3.0	3.0	1.5	60%	492.3	6.09
8.	3.0	3.0	3.0	1.5	60%	455.4	6.59
9.	1.5	1.5	1.5	3.0	60%	507.6	5.91
10.	3.0	1.5	1.5	3.0	60%	465.4	6.45
11.	1.5	3.0	1.5	3.0	60%	503.0	5.96
12.	3.0	3.0	1.5	3.0	60%	449.7	6.67
13.	1.5	1.5	3.0	3.0	60%	471.1	6.37
14.	3.0	1.5	3.0	3.0	60%	451.9	6.64
15.	1.5	3.0	3.0	3.0	60%	475.4	6.31
16.	3.0	3.0	3.0	3.0	60%	437.5	6.86
	<b>a<sub>y</sub></b> [m/s <sup>2</sup> ]	<b>v<sub>y</sub></b> [m/s]	<b>a<sub>x</sub></b> [m/s <sup>2</sup> ]	<b>v<sub>x</sub></b> [m/s]	<b>α</b> [ ]	<b>t</b> [s]	<b>λ</b> [min <sup>-1</sup> ]
1.	1.5	1.5	1.5	1.5	80%	532.4	5.63
2.	3.0	1.5	1.5	1.5	80%	495.3	6.06
3.	1.5	3.0	1.5	1.5	80%	528.5	5.68
4.	3.0	3.0	1.5	1.5	80%	474.0	6.33
5.	1.5	1.5	3.0	1.5	80%	531.0	5.65
6.	3.0	1.5	3.0	1.5	80%	494.5	6.07
7.	1.5	3.0	3.0	1.5	80%	528.3	5.68
8.	3.0	3.0	3.0	1.5	80%	472.6	6.35
9.	1.5	1.5	1.5	3.0	80%	525.5	5.71
10.	3.0	1.5	1.5	3.0	80%	487.0	6.16
11.	1.5	3.0	1.5	3.0	80%	520.2	5.77
12.	3.0	3.0	1.5	3.0	80%	468.0	6.41
13.	1.5	1.5	3.0	3.0	80%	522.1	5.75
14.	3.0	1.5	3.0	3.0	80%	484.6	6.19

15.	1.5	3.0	3.0	3.0	80%	517.5	5.80
16.	3.0	3.0	3.0	3.0	80%	465.3	6.45

With the alternation of the parameters we can observe which of them impacts the required time  $t$  and consequently the throughput  $\lambda$  for the storage single command cycle. From the results of DES, we can obtain that the fill-grade factor  $\alpha$  does not significantly impact the throughput performance. This observation is not shocking and can be reasoned with explanation that in order to store new totes, the fullness of the warehouse does not significantly prolong the storing operations.

The velocity  $-v_x$  and the acceleration  $-a_x$  of the shuttles have a minor roll on the performance of the system. These two parameters influence the performance of the system, when the available empty slots are far away in the  $x$  – direction. E.g. in the Table 3 where the fill grade factor is set to 60%, meaning that almost all of the second depth of the warehouse is filled. In case 13 both velocity and acceleration of the shuttle is set to higher option. From the result we can observe the throughput is 6.37 totes/min. On the other hand, in the Table 4 where the fill grade factor predefined more room in the first depth, the throughput of the same case 13 is 5.75 totes/min.

The velocity  $-v_y$  and the acceleration  $-a_y$  of the lift have a major roll on the performance of the system. The results are clear on that from all the different fill grade factors tables. The large difference on the performance of the system can be explained as the lift being the bottleneck of the warehouse SBS/RS.

## 5 CONCLUSIONS

In this paper a discrete-event simulation was modelled of a shuttle-based storage and retrieval system. The main research topic was the storage single command cycle. The concepts behind the system were introduced, explained and converted into a simulation. In the simulation the totes were modelled as tasks. Every tote had to change five different states: lift buffer; lift table; shuttle buffer; shuttle and warehouse, to reach the goal destination. Pseudo code was specified to clarify the main loop of the simulation.

The results of a study case were given by changing the fill grade factor of the warehouse and the kinematics parameters of the vehicle systems. The major contribution to the performance of the SSB/RS had the velocity and acceleration of the lift. While the shuttle velocity and acceleration impacted the performance of the system only when empty slots were far away from the I/O point. The fill grade factor did not impact the throughput of the storing single command cycle.

In the further research impacts of other command cycles should be researched. While retrieving the totes from the warehouse another problem appears that has big potential. If the goal tote is blocked by another tote it must be relocated somewhere else. This problem is very similar to the container relocation problem that occurs in container terminals.

## References

- Carlo, J., & Vis, I. F. A. (2012). Sequencing dynamic storage systems with multiple lifts and shuttles. *International Journal of Production Economics*, 140(2), 844-853. doi: 10.1016/j.ijpe.2012.06.035
- Lerher, T., Sraml, M., Potrc, I., & Tollazzi, T. (2010). Travel time models for double-deep automated storage and retrieval systems. *International Journal of Production Research*, 48(11), 3151-3172. doi: 10.1080/00207540902796008



- Lerher, T, Ekren, B. Y., Dukic, G., & Rosi, B. (2015). Travel time model for shuttle-based storage and retrieval systems. *International Journal of Advanced Manufacturing Technology*, 78(9-12), 1705-1725. doi: 10.1007/s00170-014-6726-2
- Ning, Z., Lei, L., Saipeng, Z., & Lodewijks, G. (2016). An efficient simulation model for rack design in multi-elevator shuttle-based storage and retrieval system. *Simulation Modelling Practice and Theory*, 67, 100-116. doi: 10.1016/j.simpat.2016.03.007
- Potrc, I., Lerher, T., Kramberger, J., & Sraml, M. (2004). Simulation model of multi-shuttle automated storage and retrieval systems. *Journal of Materials Processing Technology*, 157-158, 236-244. doi: 10.1016/j.jmatprotec.2004.09.036

### **Contact information**

**assist. Jakob Marolt, M.Sc. Eng.**

University of Maribor, Faculty of Logistics  
Mariborska cesta 7, 3000 Celje, Republic of Slovenia  
E-mail: jakob.marolt@um.si  
ORCID: 0000-0001-8162-8163

**prof. Tone Lerher, Ph.D.**

University of Maribor, Faculty of Logistics  
Mariborska cesta 7, 3000 Celje, Republic of Slovenia  
E-mail: tone.lerher@um.si  
ORCID: 0000-0001-7474-182X

doi: 10.7441/dokbat.2019.065

# COMPANY PERFORMANCE BASED ON HUMAN RESOURCE PRACTICES: CASE STUDY IN THE SOUTHWEST REGION OF ROMANIA

*Mădălina Dumitrița Maticiuc*

## **Abstract**

In this paper we have pursued a study that aims at human resources practices on the performance of the company. The main objectives of the present research are: 1) to identify the effect of human resources practices on the workplace and on the reward of the employees; 2) the effects of human resources practices on company performance, on customer satisfaction, market efficiency and financial performance. The research was divided into a theoretical first part, followed by an applicative part. The analysis was carried out on a sample of 50 organizations, most of them being of Romanian origin and representing SMEs, located in the southwestern area of Romania. The scales used to measure the constructs used in the research were taken from previous research in which they were validated. The conclusions of the present case study emphasize the effect of human resources practices on the performance of the company. The human resources practices regarding the workplace, in this case, seem to have no effect on the performance of the company. In contrast, human resources practices regarding reward have a major influence on the performance of the company. The only variable that is not significantly influenced by these practices is financial performance.

*Keywords:* human resources practices, company performance, motivation, customer satisfaction

## **1 INTRODUCTION**

Under the conditions of the current economy, the complexity of the management process is going deeper, a phenomenon determined not only by the multitude and diversity of the activities that must be organized and coordinated but also by the differentiation required in the allocation of resources. Of all the input elements of the economic-social system, the human resource is the one that synthesizes and expresses the most suggestive necessity of management, as a type of specialized human activity, necessary for the efficient organization, coordination, training, motivation and control of all the activities carried out in within an organization. Not all the time in the companies their importance is appreciated at the real value. However, regardless of the attitude encountered in the practice, the importance of the employees is an essential one. Precisely for this reason, human resources are associated with notions that reveal their importance. Starting from their role within the organization we can characterize in a general way human resources, as being a factor that can directly influence the level of the performance of the organization being involved in the planning and development of its activity.

In this context, we can say that without the effective presence of people who know what, when and how to do it, it is simply impossible for organizations to reach their goals. Human resources are nothing more than the assets of the enterprise that serve to put into practice the objectives of the organization, means that can condition the success of the organization, through the efficient use of financial, material, institutional resources, by the way in which they put their intellectual and creative capacities in the pursuit of tasks fulfilment. Although studies on the relationship between human resources management and the performance of organizations are found in the literature (Georgiadis & Pitelis, 2012), they mainly focus on large firms in

developed countries. Analysis of this relationship in small businesses has been highlighted in studies addressing managers' perceptions of the success of human resources practices, and in which the main findings are aimed at their recognition that human resource practices play an elementary role in achieving the goals of companies (Gbolahan, 2012; Newman & Sheikh, 2014).

Even if human resources have a significant role in the creation of Romanian SMEs (Ceptureanu et al., 2012), the studies carried out on this topic in Romania (Lafuente & Rabetino, 2011; Antohi & Moraru, 2016; Marin, 2015), are being focused on problems in staff retention once they are trained through training. Various authors bring encouragement as researchers to develop context-specific approaches to human resource performance assessment, which helps to demonstrate the external validation of research models, by developing context-relevant models (Iqbal, Akbar, & Budhwar, 2014). Thus, one can observe the need for research aimed at investigating human resources practices that have an impact on the performance of the organization. The factors of the organizational context identified, with influence on human resources practices, can be the basis of building strategies to increase the performance of employees and of organization.

In this paper is considered that human resources practices are the means by which companies can influence and model the abilities, attitudes and behaviour of individuals, valuing their work and achieving organizational goals. The research aims at two main objectives, namely: a) to identify the effect of orienting the human resources practices on the workplace and on the rewards of the employees; b) to identify the effect of the firm's performance on customer satisfaction, on the market efficiency and on the financial performance.

## **2 PERFORMANCE OF HUMAN RESOURCES IN ORGANIZATIONS**

The role of human resources is obvious when we talk about increasing efficiency. People are the active resources of the organization. They have potential, experience and can put all their passion into the work they provide. In this way, it actively contributes to the increase of organizational efficiency and effectiveness, having the capacity to greatly amplify the effect of using other resources through synergy. The individuals represent the factor that can directly influence the performance level of the organization being involved in the planning and development of its activity.

Performance appraisal and reward are some of the human resources practices that companies can use to improve employee behaviour and determine them to achieve the organizational goals at the level the organization wants. Regarding the evaluation of professional performance, companies want to generate the desired behaviours of their employees, giving them feedback and incentives that reinforce the respective behaviours.

Human resources management practices can be a source of competitive advantage, sustainable and perennial, supported by skills and knowledge that can hardly be imitated (Barney, 1995). Chen and Huang (2009) indicate that a system of human resources practices is directly related to several dimensions of operational performance. Similarly, there have been several studies such as those of Ichniowski et al. (1997) that examine the productivity effects of the following innovative work practices: pecuniary incentives, recruitment, selection, teamwork, workplace flexibility, job security, communication, training. These authors suggested that these practices lead to higher levels of productivity than traditional practices characterized by the limited scope of work, strict working rules, payment of hourly pay and close supervision.

Theoretical and empirical HRM research has led to a general consensus that the method used by a firm to manage its workforce can have a positive impact on firm performance (Way, 2002).

Previous studies have emphasized the link between human resource practices and organizational outcomes, such as productivity, flexibility and financial performance. Chen and Huang (2009) added performance to innovation, the latter being a key element of today's society.

The way employees are treated and encouraged is strongly linked to how they are willing to provide superior value to customers, engaging in innovative approaches used to meet the customer. Market orientation is closely linked to innovation and customer value. If human resource practices are effective, the benefits of entrepreneurial orientation are greater when market orientation is high. Thus, it has been shown that market orientation and human resource practices are moderators of the relationship between entrepreneurial orientation and customer value (Nasution et al., 2011). Strategic human resources practices are useful to motivate employees' desire to acquire, share and apply knowledge within the organization. Strategic practices of adequate human resources can support and promote the development of the organizational environment.

Performance in the field in which it operates is intended to be achieved by all companies, and this could ensure the success, stability and competitive advantage in a market where in the last period many players have become increasingly ambitious (Țebeian & Sărătean, 2012). The fate of an organization can be significantly influenced by a multitude of factors related to the nature of the organization's functioning as a whole, or to each individual and how it contributes to the organization's objectives.

Performance is a priority objective of an organization, but in business, it is most often associated with profit (not mandatory with immediate, short-term) and in non-profit organizations with the degree of meeting the organization's objectives measured by product indicators (output) and consequence (outcome). Training individuals to achieve performance depends on the personal characteristics of each member, organization as a system, crossed by the facilitating or inhibiting factors of performance met in these organizations, one of these factors being communication (Robertson, 2003).

Previous researchers (Shin & Konrad, 2017) have shown that at present we are increasingly pursuing the transition from human resources management to strategic human resources management, especially in the context in which we talk more and more about organizational performance. The success of an organization depends on its ability to continuously learn, to create the environment needed to learn together from its members, to acquire and share knowledge through synergy, to evolve with employees (Ciurea & Demyen, 2019).

Today's organizations are beginning to acquire several agile characteristics, becoming centres in which people from different professions interact. Hierarchy tends to become more and more often based on distinctive competencies, and interpersonal relationships have become more depersonalized. and proper motivation. In such a context, it is difficult to determine what is the profile and personality of the successful manager, but the future will require management to best match the level of development of the digital world in which we live.

### **3 METHODOLOGY**

The present research is focused on the study of human resources practices on company performance. The research objectives aim at two directions namely: identifying the effect of human resources practices on the workplace on the performance of the company; and identification of the effect on the performance of the company of the human resources practices regarding the reward. Based on the theoretical foundations as well as the results of previous

empirical research, we formulated the hypotheses that were the basis of the conceptual model of the research.

Data were obtained through a questionnaire-based survey. The analysis was carried out on a sample of 50 organizations, most of them being of Romanian origin and representing SMEs, located in the southwestern area of Romania. Respondents were given assurances regarding the confidentiality of individual responses. Data processing was performed in SPSS. The scales used to measure the constructs used in the research were taken from previous research in which they were validated. For the human resources practices, we used the 10 items identified in Nasution et al. (2011), and for the company's performance, a number of 12 items, taken from Vorhies and Morgan (2005). Each construct of the research model of was analysed in following steps: a) determination of the alpha-Cronbach coefficient to determine the reliability level of the scale; b) the analysis of the Kaiser – Meyer – Olkin indicator and the application of the Bartlett test in order to determine the opportunity for carrying out the factor analysis; c) carrying out exploratory factor analysis in order to purify the measurement scales by eliminating the variables that negatively affect the convergent validity of each construct.

The two hypotheses from which I started this paper are:

H1: Human resources practices regarding the workplace have a direct, positive and significant influence on: a) the performance of the company; b) customer satisfaction; c) market efficiency and d) financial performance.

H2: The human resources practices regarding the reward have a direct, positive and significant influence on: a) the performance of the company; b) customer satisfaction; c) market efficiency and d) financial performance.

The scales for measuring the constructs used in the research were taken from previous research in which they were validated, according to Table 1 and Table 2.

Tab. 1 – Items of scale for human resources practices. Source: Nasution et al. (2011)

Construct	Scale Items	Variable Codes
Human resources practices regarding the workplace	(1) Employees are adapted to the specific requirements of each job	APCSLM
	(2) Treating employees as the most valuable resources of the organization	TAVRO
	(3) The employees of the organization are provided with extensive training programs.	AAPEF
	(4) Emphasizing the importance of having satisfied employees.	AIFAM
	(5) Employees are provided with clear career steps	AAPCC
	(6) Employees have guarantees regarding job security	AGSLM
	(7) The high level of motivation of the employees	NRMA
The reward of the human resources practice regarding the reward system	(8) The performance of the employees is rewarded.	RPOA
	(9) Bonuses for outstanding employee performance.	BPR
	(10) Effective feedback to employees on performance	FOAP

In order to carry out the hypothesis testing, the following statistical models were designed and used:

$$M1: PRULM + PRUR = PFM$$

$$M2: PRULM + PRUR = SCL$$

$$M3: PRULM + PRUR = EP$$

$$M4: PRULM + PRUR = PFN,$$

Where PRULM = human resources practices regarding the workplace;

PRUR = human resources practices regarding reward;

PFM = company performance;

SCL = customer satisfaction;

EP = market efficiency;

NFP = financial performance.

Tab. 2 – Performance Measures: (Company Performance). Source: Vorhies & Morgan (2005)

Construct	Scale Items	Variable Codes
Customer satisfaction	(1) Customer satisfaction	SC
	(2) The size of the value offered to customers	MVOC
	(3) Meeting the expectations of customers	ÎAC
	(4) Maintaining valuable customers	MCV
Market effectiveness	(5) Market share in relation to competition	CPRC
	(6) Increased sales revenue	CVV
	(7) Attracting new customers	ANC
	(8) Increase sales to existing customers	CVCE
Financial performance	(9) The profitability of the business unit	PUA
	(10) Return on investment	RI
	(11) Profitability of sales	RV
	(12) Meeting the financial objectives	ÎOF

## 4 RESULTS OF THE RESEARCH

The sample consists almost entirely of companies with full capital of Romanian origin, most being small and medium-sized companies. The majority share in the total sample is owned by the companies that operate in the sales and services sector. The respondents from the questions in the questionnaire are the administrators in the case of 38% of the companies, the rest up to 100% being made up of 36% managers, or persons delegated by the management of the companies to answer the questionnaire. The majority share of the total sample is held by respondents with training in the economic field followed by those with training in the technical field. The simple linear regression analysis was used to test the hypotheses of the research model, the non-standardized coefficient B of the regression function, the t-statistic and the significance level p were retained in order to make the decision to accept or reject each hypothesis.

The results of the hypothesis testing can be found in Table 3 and Table 4.

Tab. 3 – Results of the testing H1 hypothesis (workplace). Source: own research

Hypothesis	Model used	Significance level p of the model	Standardized coefficient beta	Statistical value t	Significance level p of the concept	Coefficient of determination R <sup>2</sup>	Result
H1a	M1	0.003	0.169	1.251	0.217	0.219	Rejected
H1b	M2	0.001	0.159	1.220	0.229	0.276	Rejected
H1c	M3	0.019	0.108	0.769	0.446	0.159	Rejected
H1d	M4	0.212	0.184	1.266	0.212	0.101	Rejected

The hypothesis in the above table cannot be validated, because the significance levels p of the related model does not present a statistically significant level. Therefore, the variable practices of human resource resources do not have a direct, positive and significant influence on company performance, customer satisfaction, market efficiency, financial performance.

Tab. 4 – Results of the testing H2 hypothesis (reward). Source: own research

Hypothesis	Model used	Significance level p of the model	Standardized coefficient beta	Statistical value t	Significance level p of the concept	Coefficient of determination R <sup>2</sup>	Result
H2a	M1	0.003	0.393	2.909	0.006	0.219	Accepted
H2b	M2	0.001	0.460	3.533	0.001	0.276	Accepted
H2c	M3	0.019	0.356	2.538	0.015	0.159	Accepted
H2d	M4	0.212	0.216	1.487	0.144	0.101	Rejected

We note in the table above that in the case of the research hypothesis H2a, according to the model used M1, the human resources practices regarding the reward have a direct, positive and significant influence on the performance of the company, registering a standardized beta coefficient of 0.393, with a significance level  $p = 0.006$ . Model M1, however, has a coefficient of determination  $R^2$  0.219, being inferior in terms of explanatory power. In conclusion, hypothesis H2a, the human resources practices regarding the reward have a direct, positive and significant influence on the performance of the company, is accepted.

In the case of the research hypothesis H2b, according to the model used M2, the human resources practices regarding the reward have a direct, positive and significant influence on the satisfaction of the clients, registering a standardized beta coefficient of 0.460, with a significance level  $p = 0.001$ . Model M2, however, has a coefficient of determination  $R^2$  0.276, being inferior in terms of explanatory power. In conclusion hypothesis H2b, human resource practices regarding reward have a direct, positive and significant influence on customer satisfaction, is accepted.

In the case of the research hypothesis H2c, in the M3 model, the effect of this variable on the market efficiency is not significant. In case, the dimensions of human resources practices are taken alone, the effect of human resources practices on the reward is insignificant. The M3 model, however, has a coefficient of determination  $R^2$  0.159, being superior in terms of explanatory power. So we can say that the hypothesis H2c is accepted. The H2d hypothesis in the above table is not validated, because the significance levels  $p$  of the related model does not present a statistically significant level. Therefore, the variable practices of human resource resources do not have a direct, positive and significant influence on company performance, customer satisfaction, market efficiency, financial performance.

## 5 CONCLUSIONS

We live in a society in which the changes happen very quickly and in which, for the business world, the challenges and the obligation of change are related to the field of normality. The tendencies registered in the management of human resources represent real challenges for the managers of the organizations, therefore, we can say that in a society that is constantly changing and developing, with organizations as the measure, the exigencies regarding the managerial qualities evolve continuously. In such a situation, human resources managers are confronted with a special situation: they must adapt their work very quickly, they must understand the business context in which they operate, how these changes, where the company is placed on the market to be able to provide the right management solutions. This implies more flexibility, adaptability and availability to understand the business. The greatest influence of human resources practices on reward is on customer satisfaction, so to have satisfied employees we have to look at the way of reward. The second place among the influences of the reward is the performance of the company, construct, which in turn includes customer satisfaction. For market efficiency, it is sufficient to consider only human resources practices.

The results of the present research are useful for the managerial practices of the companies, as well as of the educational institutions we could say. In order to meet the established performance objectives, the top management teams must ensure a high level of human resources practices in terms of reward and a high level of engagement in learning. It should be emphasized that, in order to have satisfied customers, a reward is essential as the efforts are made, as well as the fact that the organization will assume responsibility and will commit itself to provide training. The main limits of this research are generated by the small size of the sample on which the research was conducted. In the future, research in the chosen topic area can be continued by detailing data analysis using advanced methods. Cluster analysis can be used to identify the particularities in manifesting the relationships investigated within the different categories of companies.

### **Acknowledgement**

This work was cofinanced from the European Social Fund through Operational Programme Human Capital 2014-2020, project number POCU/380/6/13/125015 "Development of entrepreneurial skills for doctoral students and postdoctoral researchers in the field of economic sciences".

### **References**

- Antohei, I., & Moraru, A. (2016). The High Performance Work Practices and Labour Productivity in Romanian Companies. *Ovidius University Annals, Economic Sciences Series*, 0(2), 291-296. Retrived from <http://stec.univ-ovidius.ro/html/anale/ENG/2016/2016-II-full/s4/1.pdf>
- Barney, J. (1995). Looking inside for competitive advantage. *Academy of Management Executive*, 9(4), 49-61. doi: 10.5465/ame.1995.9512032192
- Ceptureanu, S., Ceptureanu, E., Tudorache, A., & Zgubea, F. (2012). Knowledge Based Economy Assessment in Romania. *Economia: Seria Management*, 70-87. Retrieved from <https://ideas.repec.org/a/rom/econmn/v15y2012i1p70-87.html>
- Chen, C., & Huang, J. (2009). Strategic human resource practices and innovation performance: The mediating role of knowledge management capacity. *Journal of Business Research*, 62(1), 104-114. doi: 10.1016/j.jbusres.2007.11.016
- Ciurea, J., & Demyen, S. (2019). The Employee Perception on the Importance of Organizational Culture for the Future of an Enterprise. *Annals-Economy Series*, 3, 237-244. Retrieved from [http://www.utgjiu.ro/revista/ec/pdf/2019-03/31\\_Ciurea.pdf](http://www.utgjiu.ro/revista/ec/pdf/2019-03/31_Ciurea.pdf)
- Gbolahan, F. (2012). Impact of human resource management practices on organizational performance in Nigeria. *International Journal of Contemporary Business Studies*, 43-48. Retrieved from <http://bit.ly/2TSoPS2>
- Georgiadis, A., & Pitelis, C. (2012). Human resources and SME performance in services: Empirical evidence from the UK. *International Journal of Human Resource Management*, 23(4), 808-825. doi: 10.1080/09585192.2011.561236
- Ichniowski, C., Shaw, K., & Prennushi, G. (1997). The effects of human resources management practices on productivity: A study of steel finishing lines. *American Economic Review*, 87, 291-313. Retrieved from <http://ecsocman.hse.ru/rubezh/msg/19043515.html>



- Iqbal, M., Akbar, S., & Budhwar, P. (2014). Effectiveness of performance appraisal: an integrated framework. *International Journal of Management Reviews*, 17(4), 510-533. doi: 10.1111/ijmr.12050
- Lafuente, E., & Rabetino, R. (2011). Human capital and growth in Romanian small firm. *Journal of Small Business and Enterprise Development*. 18(1), 74-96. doi: 10.1108/14626001111106442
- Marin, I. (2015). Human resources insights regarding Romanian SMEs. *Proceedings of the 9th International Management Conference "Management and Innovation for Competitive Advantage"*, 9(1), 606-613. Retrieved from <https://ideas.repec.org/a/rom/mancon/v9y2015i1p606-613.html>
- Nasution, H., Mavondo, F., Matanda, M., & Ndubisi, N. (2011). Entrepreneurship: Its relationship with market orientation and learning orientation and as antecedents to innovation and customer value. *Industrial Marketing Management*, 40(3), 336-345. doi: 10.1016/j.indmarman.2010.08.002
- Newman, A., & Sheikh, A. (2014). Determinants of best HR practices in Chinese SMEs. *Journal of Small Business and Enterprise Developments*, 21(3), 414-430. doi: 10.1108/jsbed-05-2014-0082
- Robertson, P. (2003). The role of training and skilled labour in the success of SMEs in developing economies. *Education and Training*, 45(8/9), 461-473. doi: 10.1108/00400910310508856
- Shin, D., & Konrad, A. (2017). Causality between high-performance work systems and organizational performance. *Journal of Management*, 43(4), 973-997. doi: 10.1177/0149206314544746
- Țebeian, A., & Sârătean, E. (2012). The Impact of Motivation on Performance through Leadership. *Proceedings of the International Management Conference*, 6(1), 296-303. Retrieved from <http://conferinta.management.ase.ro/archives/2012/pdf/36.pdf>
- Vorhies, D., & Morgan, N. (2005). Benchmarking marketing capabilities for sustained competitive advantage. *Journal of Marketing*, 69(1), 80-94. doi: 10.1509/jmkg.69.1.80.55505
- Way, S. (2002). High performance work systems and intermediate indicators of firm performance within the US small business sector. *Journal of Management*, 28(6), 765-785. doi: 10.1177/014920630202800604

## Contact information

### **Mădălina Dumitrița Maticiuc, Ph.D.**

West University of Timisoara, Faculty of Economics and Business Administration

Str. J.H.Pestalozzi, nr. 16, 300115, Timișoara, Romania

E-mail: [madalina.maticiuc@e-uvt.ro](mailto:madalina.maticiuc@e-uvt.ro)

ORCID: 0000-0003-1082-8998

doi: 10.7441/dokbat.2019.066

# INNOVATIONS IN THE DISTRIBUTION OF INTELLECTUAL PROPERTY IN THE DIGITAL ERA

*Martin Matušovič*

## **Abstract**

This thesis examines innovation, intellectual property and forms of distribution, focusing on selected forms of film distribution. Our aim was to investigate innovations in terms of updating their typology with a focus on social innovation, to examine intangible intellectual property products in the enterprise and to examine the distribution of selected intangible products from the consumer's point of view on the importance of selected parameters and selected platforms for audio-visual distribution. We used quantitative survey methodology, we used quantitative statistical methods. Data were analysed in the PSPP statistical program and evaluated by correlation and regression analysis. The results of the survey show that businesses are aware of the importance of social innovation, intellectual property and innovative distribution channels are required in the distribution of audio-visual works.

*Keywords: distribution channel, distribution management, copyrights, film distribution, cinema distribution, VoD platforms*

## **1 INTRODUCTION**

This thesis examines innovation, intellectual property and forms of distribution, focusing on selected forms of film distribution. Our first goal was to explore innovations to update their typology. In the last decade we have seen the existence of important social processes (challenges or phenomena) that theory, practice and respondents understand as "social" innovation. This "new type" of innovation is in many ways different. Our second goal was to explore the intangible intellectual property products in the business. Our research is based mainly on accounting data, internal non-accounting records / standards / and external sources of intellectual property information in companies. Our third objective was to investigate the distribution of selected intangible products from the perspective of consumers' views on the importance of selected parameters and on the importance of selected audio-visual distribution platforms. Most respondents agreed that cinema ticket prices were above average. According to respondents, the most popular VoD platforms are the distribution of films with a strong growth trend for the future.

We used quantitative survey methodology, we used quantitative statistical methods. Data were analysed in the PSPP statistical program and evaluated by correlation and regression analysis. The results of the survey show that businesses are aware of the importance of social innovation and that innovative distribution channels are required in the distribution of audio-visual works.

## **2 STATE OF KNOWLEDGE**

Distribution is one of the tools of the marketing mix. Its task is therefore to ensure the efficient movement of goods or services through distribution channels from the seller to the target customer. It can be understood as a set of operations that helps the goods, respectively the service reach the consumer in the right quantity, quality, price, location and time, and has contributed to satisfying his needs (Tóth, 2016). This entire delivery process needs to be effectively managed, otherwise it could lead to chaos in the organization, and it is this effective

management that distribution management deals with. Distribution management is “management of the resources and processes used to deliver a product from production to point of sale, including storage and including wholesalers and retailers. Distribution management also includes determining optimal product quantities for delivery to individual warehouses or points of sale to ensure the most efficient and efficient delivery to the customer” (Kansal & Kapoor, 2005). Distribution Management can be defined as the part of management that serves as a link between orders, production, marketing, sales and finance, ensuring proper functioning, bringing synergies to all activities. Some authors (Daño & Kita, 2009) consider distribution management to be “part of logistics that deals with the management of the movement of goods and services through various distribution channels, transport, warehousing, inventory, information system, order processing and documentation”. Others in turn, they refer to as 'part of the management responsible for the design, management and operation of the movement control system for processed goods where physical distribution is only complete by satisfying consumer demand by recording the time and place of delivery and storage and final transformation of goods therefore, the goal of distribution management is to select a set of product delivery decisions to best meet customer needs. The main tasks of distribution management include: identifying the existing situation and monitoring developments in the company and its external environment for proper distribution decision-making to analyse and assess the situation and development, identify potential opportunities and threats as well as weaknesses and strengths, determine what distribution targets will be and choose appropriate strategies, plan, coordinate and control distribution activities, support and motivate distribution participants.

Certain distributors are involved in the distribution of products. They are the producer of a product and its consumer. However, most manufacturers do not deliver their goods directly to the final consumer, and use the services of intermediaries, such as distribution intermediaries and distribution assistants (e.g. wholesalers, retailers, publishers, recording studios, etc.). All these participants together create a distribution channel. All participants in this chain strive to fulfil their functions for their own benefit, but also for the benefit of the entire channel. Deciding the choice of distribution channel is very difficult and depends on various factors.

For our analysis it is important to divide by the presence of intermediaries in the distribution channel (Daño & Kita, 2009): Direct channels - the manufacturer applies his product on the market himself, i.e. sells it directly to the consumer. All distribution activities are carried out at its own expense and risk. In the case of an audio-visual work, it is a situation where the producer of the film is both a director and a screenwriter and editor and ensures its distribution itself; for home videos or copyrighted works. Indirect channel - the producer (in our case the producer of the original audio-visual work or the producer of audio-visual recordings) will involve in the realization of their products one or more intermediaries, who partially or fully take over the distribution activities and thus the costs and risk (Baker, 2002). Depending on the number of intermediaries, one or more level channels are created. At each level of the distribution channel in the marketing system, there may be different bodies, institutions that develop this distribution level (Dubcová & Majdúchová, 2016). By way of example, the distribution of films to cinemas, in which distribution companies are involved, determines the release date of the film and how the film is delivered to the customer. The choice of distribution channel is determined by several factors: size of the target market, specificity of the target market, product characteristics, distribution costs, economic potential of the producer (distributor), experience and others (Kotler & Armstrong, 2004; Bačišin, 2010).

The term film producer is not specified in the Copyright Act. However, within the meaning of Community law, the producer of the first fixation of an audio-visual work is considered to be a producer. The European Directives directly confer on the producer of the first fixation of a film

certain exclusive rights in relation to the original and copies of his film: the exclusive rental and lending right (Article 3 of Directive 2006/115 / EC), the right of distribution (Article 9 of Directive 2006/115 / EC), reproduction right (Article 2 of Directive 2001/29 / EC), right of public transmission and public access (Article 3 of Directive 2001/29 / EC) and so on. "

According to the Copyright Act, the producer of the audio-visual work resp. the producer shall be deemed to be the person who initiated or ensured its final production. Unless otherwise agreed. The exercise of property rights is dependent on the authors of the audio-visual works. They give written consent and the law requires an agreement on remuneration for the creation, use and reproduction of the work. Property rights are linked to a very important stage in the process, which is the distribution of film as an audio-visual work and how to get the film to the audience. The distributor's role is to choose the right distribution path. Distribution companies and film agents have a partial and temporary right to dispose of the rights to the film in the form of licenses and sub-licenses e.g. in the case of theatrical distribution, distribution of the film by means of television broadcasting, on the Internet, via VOD platforms, or publishing the film on DVD media. They take care of domestic and foreign PR, marketing and to ensure that as many potential customers as possible know about the film. It shall include the use of the work, the scope of the license, the time for which it is granted and the amount of remuneration for the use of the work (Adamová & Škreko, 2012). A license may be granted for one or more uses, so the specific use of the work in the license agreement must be well defined. The author may give the user permission to sub-license the third party persons, therefore consent for further use of the work can also be granted by the user himself, not just the author. The royalty for the use of the work may be agreed as a precisely determined price, for example 1000 € or can be set as a percentage of the sale price of the carrier, ticket price, etc. (Baláž, Kluvánková-Oravská & Zajac, 2007). Given that it may be difficult for authors to track the use of their works and take care of their contractual matters, they may be represented by a collective management organization (Piko, 2019). It is a representation of authors or heirs in certain copyrights.

Research on "classic innovation" highlights divergent views on the main drivers of innovation (Grančičová, 2016). Although innovation leads to increased performance (Welbourne, Neck & Meyer, 2012) and business competitiveness (Keupp & Gassmann, 2013), researchers and theories focus on various determinants and sources of innovation (Harris & Albury, 2009). Kohnová and Papula (2019) emphasize intangible assets and intellectual capital (structural, relational and human capital), analyse the contribution of human capital to company innovation, but also education and development activities that lead to increased innovation activity. Aldieri, Barra and Vinci (2019) investigating the effects of the qualitative aspect of the workforce with a focus on generating product and process innovation. Researchers have focused their attention on the impact of talent management, employee engagement in relation to business performance and innovation activity (Rybárová, 2016). Audretsch and Feldman (1996), Heneman, Tansky and Camp (2000) and Festing, Schäfer and Scullion (2013) present an original view of SMEs in their research and reveal important facts about the impact of strategic involvement of staff quality, as well as their correlation with the quality of training and development systems.

In the field of social innovation, research is carried out on 470 projects in the Finnish workplace development program aimed at developing the quality of life in the workplace within the functioning of teams (in particular the cooperation of employees and managers); the real result was increasing employment (Jones et al., 2008). Other research carried out at 398 manufacturing companies showed that employee-management consultation meetings are as important to employees as motivation and remuneration (Murray, Caulier-Grice & Mulgan, 2010). Franz, Hochgerner and Howaldt (2012) examined 212 companies operating in the field of services and trade and the introduction of social innovation has led to an increase in employee engagement and communication. Brayfield and Crockett (1955) have shown that a motivational

environment is not enough to increase employee satisfaction. They place emphasis on setting goals and meeting them. Armstrong (2006) also point to the importance of education. The Dutch Economic Institute for SMEs drew attention to the correlation of the implementation of social innovation and business performance / economic result-increase 9x, turnover-increase 2x, productivity-increase 3x, employment-increase 2x / (Franz, Hochgerner & Howaldt, 2012). We have not found any research into the distribution of intellectual property products. The issue of the interconnection of the market and intellectual property is being examined by Hrušovská (2016). Daňo and Kita (2009), Veselý (2016) and other experts are also involved in research of the distribution of tangible products.

### **3 RESEARCH METHODOLOGY AND METHODS**

We used recognized, general scientific methods to work towards this goal. To obtain information it was while studying literature used empirical methods, especially methods of observation and controlled interviews. Registration information is accompanied by the observation of phenomena from different angles. In this context, it used the method of comparison. When processing the information obtained was applied systemic approach is a general methodology of investigation and allow the distribution of the phenomenon of the partial problems without disrupting the overall context and linkages. This approach allows a comprehensive study of selected objects. In addition to the alleged methods were also used more generally accepted methods of scientific research, especially basic and most widely used methodologies such as analysis and synthesis. Analysis was used to detect links between parts of a whole, their complementarity, and influence. Synthesis, which, in comparison with the analysis of the phenomenon of reverse. It allowed us to formulate generalizations.

In the paper we used mainly general methods - it is the use of generally applicable methods in creative activity: analysis - detailing of separated problems in individual problem solutions, synthesis - a combination of information acquired in individual parts of the problem being solved, induction - a process applied in each step of a project solution from individual to more complex, deduction - a process applied in the focal stages of the solution creating a complex judgment from previous information, analogy - deduction model solution based on comparative features of comparable subjects for the desired subject, synergy - adequate complex combination of relevant methods in solving a specific task achieves the required partial goal, system approach - system classification and categorization according to representative criteria, comparison - comparison of selected attributes according to representative criteria, abstraction - concentration on the central focus of the phenomena examined and disregarding irrelevant phenomena. Specific methods were chosen with regard to the specifics of the integrated nature of the issue of marketing assets with a dominant interdisciplinary approach: communication methods (survey, structured interview, situational interview, and expert discussions), mathematical-statistical methods (correlation analysis, budgeting, and calculation) communication methods (cooperative communication using e-mail). The sources of information for processing the presented results were discussions with practitioners and a questionnaire survey carried out in the territory of the Slovak Republic. The subject of the survey was enterprises operating in the Slovak Republic. Enterprises were selected by simple random sampling. 500 questionnaires were sent to enterprises, the sample consisted of 286 companies included in the database. We chose a quantitative survey method in the form of a questionnaire, which was processed in writing. The selection of enterprises was not limited by any criteria. The selected companies were from different regions of the Slovak Republic, their size and industry were not defined and could have different legal forms. All enterprises in the Slovak Republic had the same probability of being selected for the sample. We call this selection a simple random selection. The solution is based on a quantitative survey

methodology. The aim of quantitative methodology is to verify or disprove hypotheses. We tested the hypotheses and confirmed or disproved them. In the interest of practical verification of theoretical knowledge of satisfaction and loyalty in the application part, we conducted a questionnaire survey in the Slovak Republic. We tested the validity of the null hypothesis.

*H0: There is no dependency between qualitative features A and B, respectively there is no association.*

*H1: There is dependency between qualitative features A and B, respectively there is an association.*

The test characteristic  $\chi^2$  - which has  $\chi^2$  - distribution with  $(r - 1)(s - 1)$  degrees of freedom, where  $r$  is the number of categories of variable A and  $s$  is the number of categories of variable, is used to verify the hypotheses.

We performed the analysis in the PSPP statistical program and evaluated the data using the Descriptive Statistics Cross tabulation procedure. The PSPP statistical program is mainly aimed at statisticians, social scientists and students who require rapid and convenient analysis of sample data. PSPP is a stable and reliable application. It can perform descriptive statistics, T-tests, ANOVA, linear and logistic regression, pooling rates, cluster analysis, reliability and factor analysis, non-parametric tests, and more. Its backend is designed to perform its analysis as quickly as possible, regardless of the size of the input data. GNU PSPP is a program for statistical analysis of sampled data. We used  $p$  - value as the test criterion (the lowest level of significance on which we reject  $H_0$ ), compared with  $\alpha$  ( $\alpha = 0.05$ ). If the  $p$  - value was less than  $\alpha$ , we rejected the null hypothesis and accepted the character dependence hypothesis. We used the method of purpose analysis when examining the answers of the questionnaire survey. For data processing we used quantitative statistical methods using standardized evaluation procedures.

## **4 RESEARCH DESIGN**

The aim of the research was to define the content of selected terms, to map current knowledge and models, to examine selected processes that were implemented by concrete subjects in real practice. In connection with the most comprehensive review of the current state of innovation, with an emphasis on social innovation. We summarized, organized and analysed theoretical and practical knowledge in the field of selected terms and individual types of innovations. We specified some selected problems of process management in all stages of the life cycle (from the origin of the idea to its implementation in practice). We have formulated the research objectives: - we assume that in terms of innovation there is an ambiguous understanding and use of selected terms in terms of content, literature on the content of the term social innovation is inconsistent - we assume that more than half of the respondents think they do not know or do not know exactly what social innovation is. The formulated research goals were fulfilled using standard methodical steps. They searched and studied available related literature and data. We also collected information and data through structured interviews at various professional events. We contacted representatives from practice and personally. They searched and analysed the metadata in the research area. We also conducted our own research. We selected the appropriate research tools and methods, identified the specific target object and subjects. We created a database and processed the data. We used several standard scientific research methods. In the research was used method of purpose analysis (questionnaire survey), which was focused on a selected sample of Slovak companies. The performance of the ensemble was ensured by a representative selection. Data were obtained by own survey of respondents representing selected enterprises doing business in the Slovak Republic. The aim was to examine as completely as possible the current state of innovation (including social innovation) in selected

enterprises. We have formulated a number of questions in the questionnaire in order to obtain evidence to achieve the research objectives. The questions were formulated with the aim to characterize the respondents, characterize the individual subjects of the survey and state the actual state of innovation in the business sphere. First we tried to look for data that someone had already collected and analysed before us. Therefore, we did not find a range of data that would meet the goals we formulated. For these reasons we have collected our own data.

We also examined the preferences of Slovak viewers for two forms of film distribution, and we tried to find out whether VoD platforms in Slovakia should become a key distribution channel for film distribution. A total of 72 respondents aged 15 and over participated in the survey; the upper age limit was not limited, 54% of the respondents were women and the remaining 46% were men of different education. The questionnaire was distributed electronically, containing 19 closed questions. Given that only 72 respondents participated in the survey, it is not a representative sample. The obtained data can at least partially serve to create an idea of the preferences and attitudes of Slovak viewers.

## **5 RESEARCH RESULTS**

238 respondents were actively involved in intellectual property and innovation research. The object of the investigation was a set of companies, whose structure is dominated by limited liability companies, followed by joint stock companies and sole traders. Only 36% of the companies surveyed had shareholders with foreign equity participation of 51% or more. Almost 80% of enterprises are represented in the Bratislava Region and operate from 2 to 17 years with an average life of 11 years. The average age of all surveyed enterprises is just over 14 years. The main activity of the surveyed enterprises is focused mainly on services and industrial production. Enterprises up to 100 employees make up 79% with an average of 46 employees. The average number of employees of the whole group of surveyed enterprises is 36. The above-described subject of research (group of enterprises) is analysed in detail in the following chapters of this monograph. We processed the data and analysed the result gradually, one by one, to which respondents answered the questionnaire. For some questions, respondents were offered a choice of possible answers, while others were asked to add specific information or to express the respondent's opinion. We processed open questions based on individually tailored methodologies. We analysed the respondents in detail in terms of gender, age, education and employment. Of the 238 respondents, 134 were men, representing 56%, and 104 were women, representing 44%. In terms of age, the largest group was between the eighteenth and thirty-fifth year of life, almost 77% of the total. The average age of respondents is 31.7. It is therefore relatively young people of productive age. Respondents range from 36 to 61 years and account for 21% of the total. The structure of respondents according to their education is characterized by 36.13% of university students. Secondary school education prevailed among respondents. The basic structure of respondents by occupation consisted of six types of positions, namely: owner, manager, accountant and economist, executive, external co-worker and unlisted. Some respondents, 12.19% of respondents, hold more than one position in parallel. Most respondents, less than 88%, held one job in their job. Fifteen respondents work in two jobs. Most respondents are in the position of owner or executive. No employment was reported by 7% of respondents. This group also contained 3.36% of respondents expressing their opinion as a private individual. The next most common job of respondents is manager 19%. Externally cooperating respondents make up 18%. Only 6% of respondents report as accountant or economist. In short, the structure of respondents is dominated by men of about 35 years of age. They are mostly positions of owner, executive and then manager. We can briefly characterize the analysed enterprises, the structure of legal forms, capital (including the extent of foreign participation), headquarters, age, principal activity, sectoral structure and size. The selection of these factors allowed us to

characterize the sample of companies in more detail and to take these facts into account in the analysis and conclusions. The question offered a choice of one or more legal forms of business offered and at the same time provided the opportunity for respondents to complement another institution that handles intellectual property. When formulating the question, we assumed that the respondents would also complement other institutions, not just businesses. This also happened in the range of 7.07%. However, respondents did not give details of the institutions involved. We would also like to point out that 1.35% of the respondents answered the questions put in the questionnaire as a private individual. The largest group, 33.77% of respondents, works in a limited liability company. Tightly 2.09% less, 31.68% of respondents represented the opinion of individuals not registered in the Commercial Register. The third largest group of 14.14% were respondents presenting the opinion of joint stock companies. Small groups of respondents, below 10%, are entrepreneurs registered in the Commercial Register, other institutions, cooperatives, state enterprises and public companies. No respondent representing the opinion of a limited partnership expresses an opinion on the issue of intellectual property. We still considered it necessary to point out that the file characterizing the structure of legal forms is more extensive, 371 enterprises than the number of respondents. This is because some respondents have taken advantage of the opportunity to use the experience of several positions held in different legal forms of business to answer questions. We have also taken this into account when processing the data. Respondents' answers to the equity participation documented a 60.92% dominance of exclusively domestic capital. The share of foreign capital above 51% was declared by 39.08% of enterprises. The largest share of surveyed enterprises was in the Bratislava region, almost 80%. Enterprises of other regions had a representation of 5% or less. From the results of respondents' answers we can see that almost 30% of companies have been on the market for more than 10 years. Only less than 2% of the respondents are from businesses that are doing business for a longer time. The average age of enterprises is approx. 14 years. From the point of view of activity, we have classified the companies into four main groups: production, wholesale, retail, services. The construction of the questionnaire made it possible to indicate another main focus of the activity. However, only a small proportion of respondents took this opportunity. A large group, 61.77% of businesses are mainly engaged in services. 21.43% of respondents identified production as the main activity. Less than 5% is a group of enterprises with a different focus. Most of these responses, 3.78%, could be assigned to the service group and 0.84% to the production group. Only 3.78% of respondents stated more than one main focus of the company activity. For orientation in the sectoral structure of the surveyed companies, we divided economic activities into sixteen subcategories. The companies surveyed have a balanced position in terms of sectoral structure. The frequency of respondents' statements ranges from 0.5% to 21%. We analysed the size of the analysed companies on the basis of two selected criteria, in terms of the number of employees and the estimate of annual turnover. From the processed data it was evident that 53% of respondents are employees of smaller enterprises with up to 20 employees. The second largest group is 26% of enterprises employing between 20 and 100 employees. Thus, 79% of enterprises employ up to 100 employees. Up to 46 employees on average. We can say that almost 27% of respondents expressed their opinion on behalf of companies with turnover up to 66 388, - EUR. The second highest group, surprisingly up to 24.37%, consists of companies with a turnover of more than EUR 3 319 392, -. Two of the three remaining groups account for around 20%. The average annual turnover of surveyed enterprises is up to EUR 1 454, -. Only nine respondents reported the company's actual turnover. We did not take this information into account when processing the data due to its ambiguity and insignificance. The structure of the enterprises surveyed is dominated by sole traders, limited liability companies and joint stock companies. They totalled 89.27%. Only 36% of enterprises had partners with foreign capital participation above 51% or more. Almost 80% of businesses are represented in the Bratislava Region and have been in



business from 2 to 17 years with an average age of 11 years. The average age of all surveyed enterprises was just over 14 years. The main activity was represented by services, 62% of enterprises and production. Total 85% of enterprises. The sector structure is 77% focused on industrial production (22%), finance, real estate and agriculture (10% - 11% each), tourism, social services and transport (7% - 9% each). Enterprises with up to 100 employees accounted for 79%. Their average number of employees is 46. The average number of employees of the whole group of enterprises surveyed is 36. The group of enterprises was evenly distributed in terms of turnover of 20% to 27%, with the exception of EUR 1 660 to EUR 3 319, which reported only 8 % of respondents.

Information on the subjects' innovativeness was also drawn from existing studies, which were carried out at a transnational level. The highest innovation activity was recorded in the information, communication, financial and insurance sectors. We were also interested in the development of innovative activities. The highest increase in innovation activity was Bulgaria (approx. 10%), followed by Denmark (approx. 1.9%), the Netherlands, Estonia and Ireland (approx. 1.2%), Latvia (approx. 1.6%), Lithuania (approx. Belgium and the US (approx. 0.4%). The Slovak Republic and the Czech Republic recorded an increase in innovation activity at the same level (approx. 0.2%). We saw a decline in innovation activity ranging from 0.1% (EU), 0.2% (Finland), and 0.4% (Germany, Luxembourg, Austria, France and Italy). Portugal (ca 4.8%), Malta (ca 4.2%), Greece (ca 4.0%) recorded the largest decline ... Leaders and meridian countries grew on average by 0.15%. Countries in the group of mild innovators recorded an average decline in innovation activity (1.8%) and modest innovators (4.3%). Slovakia is a medium innovator. Innovation performance increased compared to 2007 and 2014, but also decreased in 2010 and 2013. The performance of the Slovak Republic in relation to the EU has greater fluctuations. Compared to the EU, it peaked in 2012 (to 69% of the EU average), but also declined (to 64% of the EU average) in 2014. Slovakia maintains its position below the EU average in all monitored dimensions. The exception is human resources. We saw a positive shift in the share of new innovations. Weaknesses are in the active licensing of patents in non-EU countries in the application of societal challenges and patent applications. Performance in most indicators has improved. The highest increase in terms of indicators is recorded for the Community trade mark (18%). A very strong decline in performance can be seen in license and patent revenues from abroad (-38%), and a further slight decline (-8.8%) in R&D and innovation spending. Despite the fact that the Slovak Republic recorded an increase in innovation activity in the monitored period, the intensity of growth was below the EU average. The position of the Slovak Republic in innovation activity is at the level of two thirds of the EU average questionnaire - we examined the preferences of respondents - Slovak viewers to two forms of film distribution, trying to find out whether VoD platforms in Slovakia should become a key distribution channel for film distribution, by examining the attitude of Slovak viewers to paying films on the Internet. We found out how often respondents watch movies and what they prefer most to watch movies. When asked about the frequency of watching movies, most viewers said that they watch them every day or several times a week, the question did not distinguish the way they watch movies, whether they watch them on TV, cinema, on the Internet or via DVD / BluRay.

The most common form of watching movies is the Internet. It should be noted that viewing movies on the Internet may include, on the one hand, legal downloading of movies via VoD platforms, as well as pirated downloading of movies from various Internet repositories. Another very popular way of watching movies that respondents like to use is cinema or film clubs. But there is a problem in that it mainly reflects news, and a viewer who wants to watch an older film must choose a different way to watch the film. 19% of respondents said they rely on a television program offer to watch a movie. 13% said they were still buying movies on physical

media such as DVDs and BLU RAY, and only 3% said they were renting movies from stone video rentals. Our survey found that more than 41% of respondents go to the cinema once or more times a month, at least once a week more than 22% attend the cinema, 30% of the respondents visit the cinema every few months, only 4 respondents said they do not representing 6%. Less than half of respondents consider current cinema ticket price acceptable Up to 55% of respondents said they consider the cinema ticket price too high, 28% seem adequate, and 17% were unable to answer this question. Of those surveyed, up to 58% of those surveyed consider it as € 4 or less for an adult cinema ticket, € 5 is acceptable for 22% of respondents and € 6 or more seems acceptable for 20% of respondents. The most common reason for visiting the cinema is marketing the film, up to 25% of those interviewed go to the cinema mainly for films that have long been spoken about and received favourable media coverage. The other most common reasons are the ability to watch the movie in high definition and quality, and the movie experience on the big screen. Approximately the same number of respondents stated that the most common reason was the opportunity to spend time with friends and family, as well as having fun, respectively 14% of respondents said that they go to the cinema because the film cannot be seen elsewhere, so it is possible for this group that if there were other ways of watching the film they would most likely prefer it to the cinema. The most frequent reasons discouraging viewers from attending the cinema are the price of the ticket, up to 39% of the respondents chose this option, the time of the film screening with 33% of the respondents and the need to move to and from the cinema. Due to the noisy other visitors and other reasons, 11% of respondents avoid the cinema. As another reason, respondents stated that they minded the cinema ad, which they believe is unreasonably long.

VoD platforms are a relatively new distribution channel for the distribution of films; Nearly half of the respondents hardly know about the existence of VoD platforms, 42% of respondents said they did not know any such VoD platform, 44% said they had heard of a few of these services that make their films available on the Internet. Only 14% of respondents said they knew quite a lot. We also asked respondents what VoD platforms they knew, with Voyo, iTunes and Google play being among the most common to name.

## 6 DISCUSSION

There are minimal differences in opinion on the essence of classical innovations. We do not see them as essential. These are rather minor cosmetic treatments. The differences in the authors' opinions on the essence of social innovation differ significantly. We have come to understand the nature of social innovation more or less differently from the nature of classical innovation. On the other hand, we have also come to believe that every innovation is social. We are in favour of the first group of opinions. We see differences in processes (research, development, financing and others), in terms of effects (impacts) on the subjects concerned. We examined the stages of the process of social innovation from the creation of the idea (idea) to the successful implementation. We diagnosed significant specificities of individual stages in comparison with classical innovations. In the processes and effects of social and classical innovation, we have diagnosed these most significant differences.

We have come across social innovations when researching innovation in general. They are characterized by significant inconsistencies in respondents' understanding of their essence in literature. This "new type" of innovation is in many ways different from classical innovation, the social innovation effect "returns" to third parties and has specific forms of distribution. It is not possible to use standard forms of economic return calculations, monitoring of implementation and evaluation of impacts. The success of social innovation does not correlate with the cost of research. Just like classic innovations. The lifetime of social innovation is based

on other bases, calculations, or parameters compared to classical innovations. It is difficult to collect comparable data for social innovation due to the uniqueness of individual innovations. We investigated whether respondents had already met with social innovation and what social innovation activities they carried out in any of the dimensions already mentioned. How often social innovation activities are carried out, whether they are of a regular or rather occasional nature. Detailed statistics were presented in the previous chapter. We also examined the nature, motives, benefits, risks and costs of implementing social innovation, as well as the statistical correlation of the motives, benefits and risks of social innovation. The correlation has been confirmed.

Tab. 1 – Correlation of motives, possible benefits and risks. Source: own research

	A	B	C	D	E	F	G	H
motives SI_ (A)	1							
motives SI_POCK (B)	-0,37	1,00						
motives SI_POCK_I (C)	-0,23	<b>0,94</b>	1,00					
motives SI_KOMB (D)	<b>0,51</b>	-0,72	-0,68	1,00				
motives SI_POCK_I (E)	<b>0,34</b>	0,01	<b>0,34</b>	0,00	1,00			
benefits SI_KOMB (F)	<b>0,50</b>	-0,70	-0,66	<b>1,00</b>	-0,01	1,00		
benefits SI_POCK (G)	-0,42	<b>0,63</b>	<b>0,59</b>	<b>-0,89</b>	0,01	-0,90	1,00	
risks SI_KOMB (F)	0,16	-0,20	-0,19	<b>0,30</b>	-0,02	<b>0,30</b>	-0,26	1,00
risks SI_POCK (CH)	-0,11	0,04	0,06	-0,11	0,05	-0,11	0,15	<b>-0,57</b>
risks SI_I (I)	0,01	-0,06	-0,01	-0,03	0,13	-0,03	0,04	0,09

We were also interested in realizing specific types of social innovation. We were wondering which types of social innovation the companies surveyed carried out, in which years they put them into practice, for which target group, for how many users and how much costs they incurred and what the effects of social innovation brought. (Fig. 1)

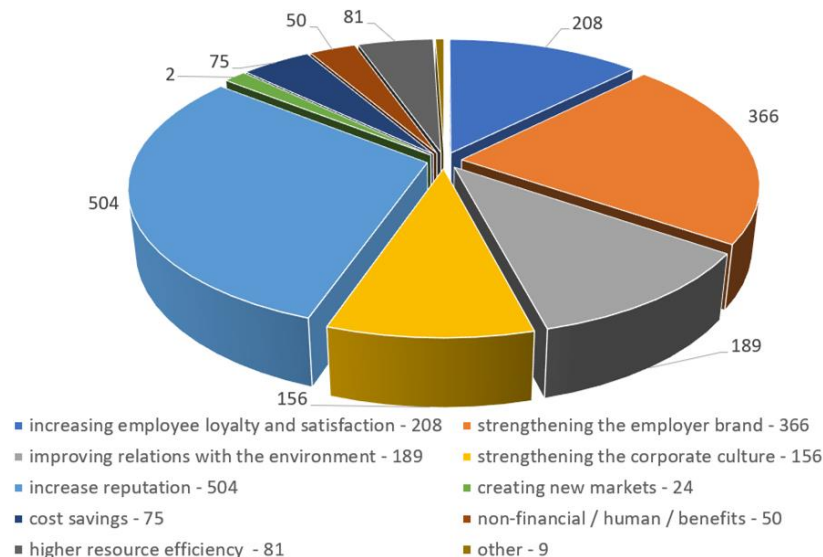

Fig. 1 – Benefits from implementing social innovations. Source: own research

Recently, we have seen an increase in the frequency of innovation. One reason is probably the limited ability of the workforce to generate long-term higher productivity growth. Robots are VoD platforms are a relatively new distribution channel for the distribution of films; Nearly half of the respondents hardly know about the existence of VoD platforms, 42% of respondents said they did not know any such VoD platform, 44% said they had heard of a few of these

services that make their films available on the Internet. Only 14% of respondents said they knew quite a lot. We also asked respondents what VoD platforms they knew, with Voyo, iTunes and Google play being among the most common to name.

## 7 CONCLUSION

Recently, we have seen an increase in the frequency of innovation. One reason is probably the limited ability of the workforce to generate long-term higher productivity growth. Robots are expected to deliver productivity growth. When examining classical innovations, we have come across several opinions on their substance<sup>102</sup>. There were minimal differences in the opinions of the authors. We do not see them as essential. These are rather minor cosmetic treatments. From our perspective, however, we perceive in the last decade the existence of significant social processes (challenges or phenomena), which theory, practice and respondents understand as "social" innovation. Our doubts as to whether these new facts sufficiently reflect the current concept of innovation in general are sufficiently reflected in the perception of social innovation as an instrument, as an ability, as a product, as an innovation, as a necessity. More than 70% of respondents think they do not know or do not know exactly what social innovation is. The opinion of the essence of social innovation in the scientific literature differs significantly. Opinions range from a clear definition in general to the uniqueness of any social innovation. In connection with the results of the research of robotization in connection with communication technologies, it is necessary to radically innovate the system providing protection and security in the digital space.

From the point of view of the intellectual property records in the company, our research is based mainly on generally binding, internal standards and external sources of information in the field of intellectual property and innovation. We also have to take into account the specific fact that the research potential is not always the property of an enterprise, but also, in particular, the personality and property rights of an entity. The originator is therefore not always directly related to the undertaking. Enterprise research activities can be partially identified in the intangible assets register. Purchased results of external research activities are also problematic in the company's costs. From the point of view of intellectual property records, it relies mainly on generally binding, internally binding standards and external sources of information in this area. We must also take into account in the analysis the specific fact that the research potential is not always the property of an enterprise, but also, in particular, the personality and property rights of an entity (originator or owner). Only property rights can be transferred to third parties. The originator is therefore not always directly related to the undertaking. Enterprise research activities can be partially identified in the intangible assets register. Purchased results of external research activities are also problematic in the company's costs. Generally recognized methods of scientific research have been used, in particular the basic and most widespread methodological procedures such as analysis and synthesis, deduction and induction. The research was also used method of purpose analysis - questionnaire survey, which was focused on a selected sample of Slovak companies. Data were obtained by own survey of respondents representing selected enterprises doing business in the Slovak Republic. We have formulated a number of questions in the questionnaire in order to obtain evidence to achieve the research objective. The owners assumed a research share of 10% and managers 15%. Owners do not consider the share estimation to be substantial and managers believe the research evidence is 5% lower. Thus, they declare inconsistency of evidence with reality. The average value of the range of research activities is  $M = 7.492$ ; standard deviation  $SD = 10.9$ . Minimum value  $Min = 0$ , maximum  $Max = 50$ . The scale was filled by 238 respondents. We also investigated the correlation of selected parameters in order to identify correct parameters (indicators) for measuring the effects of realized research results. We found a correlation between research

spending, employment, turnover, wages and rewards. We have not shown a correlation between research spending and selected indicators (turnover, employment, wages or remuneration).

Our research also focused on the distribution of intangible products from the consumer's perspective. Most respondents communicated above average cinema ticket prices. According to respondents, the most popular VoD platforms are the distribution of films with a significant growth trend for the future.

## References

- Adamová, Z., & Škreko, A. (2012). *Autorské právo na školách*. Bratislava: CVTI SR.
- Aldieri, L., Barra, C., & Vinci, C. P. (2019). The role of human capital in identifying the drivers of product and process innovation: empirical investigation from Italy. *Quality & Quantity*, 53(3), 1209-1238. doi: 10.1007/s11135-018-0812-8
- Armstrong, M. (2006). *Handbook of Human Resource Management Practice*. London: Kogan.
- Audretsch, D. B., & Feldman, M. P. (1996). Innovative Clusters and the Industry Life Cycle. *Review of Industrial Organization*, 11 (2), 253-273. doi: 10.1007/BF00157670
- Bačišin, V. (2010). *Financovanie inovácií*. Bratislava: Prognostický ústav SAV.
- Baker, A. (2002). *The Alchemy of Innovation*. Pennsylvania: Spiro Press.
- Baláž, V., Kluvánková-Oravská, T., & Zajac, Š. (2007). *Inštitúcie a ekonomická transformácia*. Bratislava: VEDA.
- Brayfield, A., & Crockett, W. (1955). Employee attitudes and employee performance. *Psychological Bulletin*, 52(5), 396-424. doi: 10.1037/h0045899
- Daňo, F., & Kita, P. (2009). *Distribučný manažment*. Bratislava: Daniel Netri.
- Dubcová, G., & Majdúchová, H. (2016). *New Development of the Social and Solidarity Economy in the SR*. Paper presented at the International Conference on Current Problems of the Corporate Sector, Bratislava, Slovakia. Bratislava: EKONÓM.
- Festing, M., Schäfer, L., & Scullion, H. (2013). Talent management in medium-sized German companies: an explorative study and agenda for future research. *The International Journal of Human Resource Management*, 24(9), 1872-1893. doi: 10.1080/09585192.2013.777538
- Franz, H.-W., Hochgerner, J., & Howaldt, J. (2012). *Challenge Social Innovation: Potentials for Business, Social Entrepreneurship, Welfare and Civil Society*. Heidelberg: Springer.
- Grančičová, K. (2016). *Approaches in the Area of Marketing Performance Assessment*. Paper presented at the International Conference on Current Problems of the Corporate Sector, Bratislava, Slovakia. Bratislava: EKONÓM.
- Harris, M., & Albury, D. (2009). *Why radical innovation is needed for the recession and beyond: The Innovation Imperative*. London: NESTA.
- Heneman, R. L., Tansky, J. W., & Camp, S. M. (2000). Human Resource Management Practices in Small and Medium-Sized Enterprises. *Entrepreneurship Theory and Practice*, 25(1), 11. doi: 10.1177/104225870002500103
- Hrušovská, D. (2016). *Current Problems of the Corporate Sector Aimed at Evaluation Indicators Marketing*. Paper presented at the International Conference on Current Problems of the Corporate Sector, Bratislava, Slovakia. Bratislava: EKONÓM.

- Jones, D. C., Kalmi, P., Kato, T., & Mäkinen, M. (2008). The Effects of Human Resource Management Practices on Firm Performance - Preliminary Evidence from Finland. The Research Institute of the Finnish Economy Discussion Papers, No. 1121. Retrieved from <https://econpapers.repec.org/paper/rifdpaper/1121.htm>
- Kansal, P., & Kapoor, S. (2005). *Basic of Distribution Management: A Logistical Approach*. New Delhi: Prentice-Hall.
- Keupp, M. M., & Gassmann, O. (2013). Resource constraints as triggers of radical innovation: Longitudinal evidence from the manufacturing sector. *Research Policy*, 42(8), 1457-1468. doi: 10.1016/j.respol.2013.04.006
- Kohnová, L., & Papula, J. (2019). *Who Drives Innovation Activities? Evidence from Innovative European Countries*. Paper presented at the 15<sup>th</sup> European Conference on Management, Leadership and Governance, Porto, Portugal. Porto: Academic Conferences and Publishing International.
- Kotler, P., & Armstrong, G. (2004). *Marketing*. Praha: Grada.
- Murray, R., Caulier-Grice, J., & Mulgan, G. (2010). *The Open Book of Social Innovation*. London: NESTA.
- Piko, M. (2012). *Autorské práva nie sú zadarmo ani bez byrokracie*. Retrieved from <https://www.podnikajte.sk/dusevne-vlastnictvo/autorske-prava-nie-su-zadarmo-ani-bez-byrokracie>
- Rybárová, D. (2016). *Support for Social Innovation*. Paper presented at the International Conference on Current Problems of the Corporate Sector, Bratislava, Slovakia. Bratislava: EKONÓM.
- Tóth, M. (2016). *Self-Employed Farmer as the Element of Small Business*. Paper presented at the International Conference on Current Problems of the Corporate Sector, Bratislava, Slovakia. Bratislava: EKONÓM.
- Welbourne, T. M., Neck, H., & Meyer, G. D. (2012). The entrepreneurial growth ceiling: using people and innovation to mitigate risk and break through the growth ceiling in initial public offerings. *Management Decision*, 50(5), 778-796. doi: 10.1108/00251741211227474
- Veselý, P. (2016). *Bezpečnosť dokumentov pri práci v cloude v SME podnikoch*. Paper presented at Medzinárodná odborná konferencia Progresívne prístupy a metódy zvyšovania efektívnosti a výkonnosti organizácií, Košice, Slovakia. Košice: SAPRIA.

## Contact information

### Ing. Martin Matušovič, Ph.D.

University of Economics in Bratislava, Faculty of Business Management  
 Dolnozemska cesta 1/b, 85235, Bratislava 5, Slovak Republic  
 E-mail: martin.matusovic@euba.sk  
 ORCID: 0000-0001-6695-5967

doi: 10.7441/dokbat.2019.067

# GENERATIONAL APPROACHES AND PREFERENCES TOWARDS KNOWLEDGE SHARING: IMPLICATIONS FOR HUMAN RESOURCE PRACTICES

*Anastasiia Mazurchenko*

## **Abstract**

The 21st century is characterized by digital transformation, in which successful integration depends on the ability of employees to learn fast how to utilize new technologies and share their gained experience with colleagues. Moreover, this process is complicated by the presence of five generations of employees at the workplace at the same time, namely representatives of the Silent Generation, Baby Boomers, Generation X, Generation Y (or Millennials) and Generation Z. This paper aims to identify different attitudes and motivations of the multigenerational workforce to knowledge acquisition, reveal the main barriers to the knowledge exchange between them and create recommendations for human resource managers on how to improve knowledge sharing between different generations of employees. In this paper qualitative methodology is realized by deductive analysis and syntheses of the scientific literature and publications related to the topic. The result of this study comprises proposals in the field of personnel activities on how to support knowledge sharing and increase motivation to the learning of the multigenerational workforce. Findings from this paper confirm that human resource professionals have a chance to minimize the generational gap in the situation when the evolution of employee learning will be supported by the new engagement mechanisms and organizational culture.

**Keywords:** *multigenerational workforce, human resource management, generational differences, tacit knowledge, exchange experience*

## **1 INTRODUCTION**

Knowledge management is important for the long-term success of the company for a few reasons. First of all, it allows for improving the decision-making capabilities of the organization's top management. It also stimulates changes in the organizational culture and motivates employees in the company to creativity and innovation. The gradual increase in the diversity of generations in the workplace points to the need to pay attention to intergenerational differences to ensure efficient management of the company in today's dynamic and diverse working environment. These differences motivate HR managers to use flexible management styles to meet the needs of not only the organization but current and future employees (Al-Asfour & Lettau, 2014; Bidian & Evans, 2018).

Generational preferences play an important role in sharing organizational knowledge. This is because each generation has innate unique characteristics (for example, attitudes and views of life, work, family and social relationships) affected by historical context and generational experiences (Lowell & Morris, 2019). The choice of communication methods, learning styles and social interaction practices also vary between generations. Besides, younger generations gain knowledge in a different way than their older colleagues. They have a different perception of acquiring new skills and another approach to the use of information and communication technologies (ICT) in this process (Bidian & Evans, 2018). Consequently, improving knowledge sharing between generations at the same time requires an understanding of preferences within one generation and across different generations. HR managers are having to

confront with new challenges if they want to attract and retain talented employees and ensure knowledge sharing, that is a key to the competitiveness of an organization (Bencsik, Horváth-Csicos & Juhász, 2016).

Although job characteristics related to different generations and work attitudes were already being explored by several researchers, such as Kowske, Rasch and Wiley (2010), Parry and Urwin (2011) and Hernaus & Pološki Vokic (2014), they mainly paid attention on the generational differences of employees and didn't provide any insight on what might be done in order to improve transfer of knowledge, experience and expertise within the multi-generational workforce. It also should be noted that at this there is a limited number of relevant researches that could be used for identification of main generational preferences and motivation in the field of knowledge sharing (Heyns & Kerr, 2018; Lowell & Morris, 2019) and the major part of them doesn't cover all generations of the current workforce. Therefore, this paper focuses on identifying obstacles in the knowledge sharing process within the age-diverse workforce and providing guidance for the HR specialists on enhancing the employee motivation to learn and exchange knowledge with colleagues.

## **2 GENERATIONAL ATTITUDE TO KNOWLEDGE EXCHANGE AND ITS IMPACT ON HUMAN RESOURCE MANAGEMENT**

According to Blanchard and Thacker (2010), knowledge is defined as an organized body of facts, principles, procedures and information acquired over time. Noe (2008) claims that knowledge may be defined as a combination of information with which employees are familiar with and able to operate (human and social knowledge) and their awareness of company rules, processes and routines (structured knowledge). Another studies (Novianto & Puspsari, 2012; Jurišević Brčić & Mihelič, 2015). emphasizes the distinction between explicit knowledge, which include information expressed in formal way that can be found in office manuals, instructions or databases, and tacit or silent knowledge which is usually obtained through individual experience and learning, and which is possibly not shared with anyone.

Knowledge, intellectual capital, skills and capacities are increasingly seen as valuable intangible assets and important sources for obtaining a permanent competitive advantage by organizations (Winadi, Suzianti & Ardi, 2018). However, if employees do not share their knowledge among themselves, organizations cannot get the most out of their intellectual capital (Jurišević Brčić & Mihelič, 2015). Transforming individual knowledge into organizational knowledge is only possible if organizations will take into account different needs and expectations of their employees from knowledge exchange (Lendzion, 2015). In such a situation one of the current challenges organizations have to cope with is how to ensure the successful transfer of knowledge among employees of different generations. It is important to note that there is some disagreement among researchers in defining birth dates for each generation (Table 1). Also, different names refer to each generation. In this work, five different generations, identified by Horváthová, Bláha and Čopíková (2016), are used: (a) Silent Generation (Traditionalists, Pre-Boomers); (b) Baby Boomers; (c) Generation X (Baby Boost Generation); (d) Generation Y or Millennials (Baby Boom Echo, the Nexters); and (e) Generation Z (post-Millennials, Homeleaders, New Silent Generation).

The Greatest Generation or G. I. Generation (people born between 1901 and 1924) and Always on Generation (people born since 2011) were not taken into account because the representatives of these generations had already reached retirement age or had not yet started to work.



Tab. 1 – Different approaches to chronological definition of generations of employees. Source: own research

Generations	Date of birth next to authors			
	Horváthová, Bláha & Čopíková (2016)	Novianto & Puspasari (2012)	Gursoy, Maier & Chi (2008)	Zemke, Raines & Filipczak (2000)
Silent generation	1925-1945	1930-1945	1925-1942	1925-1946
Baby Boomers	1946-1964	1946-1964	1943-1960	1947-1960
Generation X	1965-1981	1965-1976	1961-1980	1961-1980
Generation Y	1982-1995	1977-1990	1981-2000	1981-1995
Generation Z	1996-2010	1991-2010	2001-2010	1996-2010

Today's workforce is more diverse than ever. For the first time in history, five generations meet at the workplace to work side by side (Winadi, Suzianti & Ardi, 2018). According to the research conducted by the U. S. Bureau of Labor Statistics (2017), from 2026 Millennials will form the majority of the workforce (Figure 1). However, 44% of the workforce will still be represented by the X generation and Baby Boomers whose number is estimated at 13 million in 2024.

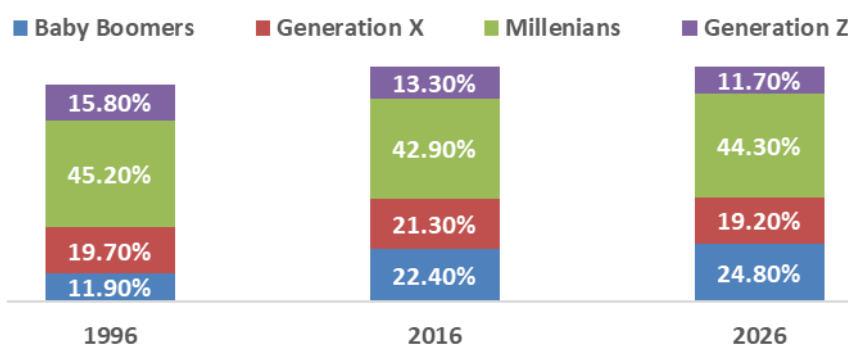

Fig. 1 – Proportion of the U.S. Labor Force by generations. Source: U. S. Bureau of Labor Statistics (2017)

According to the European Labor Force Survey (Eurostat, 2017) representatives of the Silent Generation and Baby Boomers, account for 16% of the total EU workforce in 2017. By comparison, in the EU for every 10 members of the Z generation, 12 people are aged 65 years or over (Figure 2).

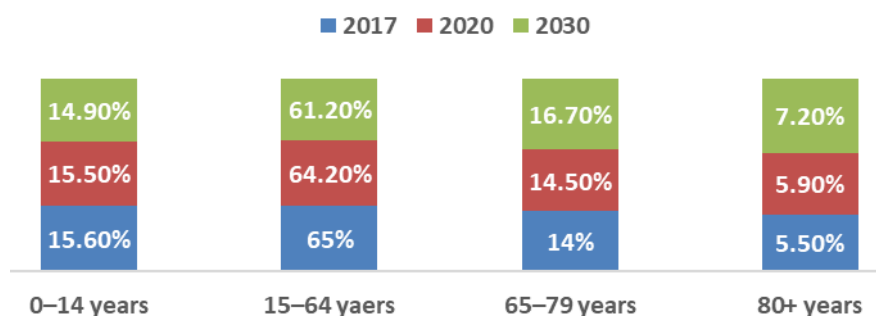

Fig. 2 – Composition of the EU population by the main age groups. Source: Eurostat (2017)

Despite increasing age diversity in the workplace, organizations' knowledge about the learning style and preferences of each generation, is limited. Free and enthusiastic participation in the learning process is largely influenced by the individual's specific motivation to acquire new knowledge and skills (Table 2). Internal motivation generally defines what people do for their interest or for internal reasons, which are the desire to improve, trust their skills and abilities, the ability to become part of a team, be recognized and have fun (Heyns & Kerr, 2018). External

motivation depends on external incentives such as material rewards or the threat of losing something due to poor performance (Axonify, 2013).

Tab. 2 – Motivation, attitude to learning and techniques for getting new knowledge. Source: own research

	Baby Boomers	Generation X	Generation Y	Generation Z
Attitude to learning	Consider it as a benefit and advantage.	Looking for career advancement and priority in the labor market.	Consider it as a direct link to the revenue increase.	Talent development and willingness to influence the world.
Motivators for learning	Perfectionism, work-holism.	Clear educational path and expectations.	Involvement in games and social networks.	New challenges and impulses.
The level of motivation	The desire for benefits for themselves, high performance.	Maintaining independence for an individual search for answers and alternatives.	In case of direct benefit to the career and personal goals.	The desire to maintain a work-life balance.
Preferred methods and tools	Learning in classes.	Learning through practice.	The information in small doses.	Finding solutions on the internet.
	Storytelling, personal communication.	Online training and tests, individual projects.	Fun and learning at the same time.	Getting feedback in real-time.

It should be emphasized that the representatives of each generation have requirements, attitudes and overall expectations, which are quite different from the previous generation, which fundamentally changes the style of cooperation and communication with the rest of employees and human resources managers (Horváthová, Bláha & Čopíková, 2016). These differences create obstacles to the transfer of knowledge from generation to generation and consequently challenges in human resource practices (Heyns & Kerr, 2018). This is quite important because human resource managers are responsible for ensuring that every employee is productive in the workplace. It should be noted that identifying, recognizing and adopting different value systems for each age group allows the organization to bridge the differences between them (Novianto & Puspasari). The first step to achieving this is to understand how and with which tools representatives of different generations communicate, cooperate, exchange ideas and experience with colleagues (Table 3).

Tab. 3 – Properties of four generations in terms of knowledge sharing. Source: own research

	Baby Boomers	Generation X	Generation Y	Generation Z
Teamwork	Need for friendship.	Independent style of work.	Belief in common success.	At the virtual level (if they are forced).
Attitude to exchange knowledge	Readily, voluntarily.	Cooperation.	In case of their interest.	At the virtual level, fast, easily, publicly.
Interpersonal relationships	Mainly personal.	Personal and virtual networks.	Mainly virtual networks.	Virtual and superficial.
Use of ICT	Incomplete knowledge.	Use safely.	Part of everyday life.	Intuitive.
Training, education, development	Traditional education.	Shorter learning time, interactive.	Fast, individual, just in time.	If they are interested, informal learning.
Conflict management	Avoid conflicts or looking for a solution.	Willingness to compromise.	Opposing, call for conflicts.	Call for conflicts, don't react or react aggressively.

There is no doubt, that the Silent Generation and Baby Boomers have comprehensive knowledge of the organization, its policy, procedures, processes, culture, and have a wide network of specialized contacts (social capital). As a result, HR managers face the need to develop strategies to retain this knowledge from older workers and successfully transfer it to other employees in the company (Bidian & Evans, 2018). At the same time, Z-generation

employees are expected to enter the labour market, bringing a technology-oriented mentality. Their adaptation, development of long-term cooperation with them and also the search for the best motivation tools for them also becomes one of the serious tasks for human resource managers (Bencsik, Horváth-Csikós & Juhász, 2016).

### 3 METHODOLOGY

The paper has focused on analysing generational differences and preferences in the area of motivation and attitude to learning and personal development, as well as identifying main barriers that occurred between them in the knowledge sharing process. Here are also considered possibilities for HR professionals connected with stimulating knowledge sharing within the multigenerational workforce. This paper is aimed to answer the next research questions: (1) How to encourage knowledge sharing in a company which has different generations to prevent knowledge loss and conflicts between them? and (2) Which approaches and techniques HR managers can use to satisfy the needs of different generations in knowledge sharing?

Within this topic, a systematic literature review and selective research as a part of a qualitative methodology are conducted. Keywords used to find scientific materials relevant to the area of this research are knowledge management, generations, HR challenges, learning preferences, multigenerational workforce, and generational differences and so on. Secondary data used for this study are scientific articles, conference papers and books published in the databases Web of Science, Science Direct, EBSCO, SpringerLink and Willey Blackwell (Table 4). For the deductive analysis, syntheses, drawing analogies and making predictions about the proportion of the labour force by generations are also used a secondary data from statistical websites Eurostat and U. S. Bureau of Labor Statistics.

Tab. 3 – The overview of analysed articles for a conceptual framework. Source: own research

No.	Authors	Area of the research	Year	Country of publication
1	Gursoy, Maier & Chi (2008)	Work values and generational gaps in the hospitality workforce	2008	United Kingdom
2	Stevens (2010)	Using knowledge management for knowledge transfer in the multi-generational workforce	2010	Canada
3	Kowske, Rasch & Wiley (2010)	An empirical examination of generational effects on work attitudes	2010	United States
4	Parry & Urwin (2011)	Generational differences in work values	2011	United States
5	Novianto & Puspasari (2012)	A Case Study (knowledge management system implementation in a company with different generations)	2012	Netherlands
6	Hernaus & Pološki Vokic (2014)	Work design for different generational cohorts	2014	United Kingdom
7	Al-Asfour & Lettau (2014)	Strategies for leadership styles for a multi-generational workforce	2014	United States
8	Jurišević Brčić & Mihelič (2015)	Knowledge sharing between different generations of employees in Slovenia	2015	United Kingdom
9	Lendzion (2015)	Human resource management in the organizational knowledge management	2015	Netherlands
10	Bencsik, Horváth-Csikós & Juhász (2016)	X and Y Generation at the workplace	2016	Czech Republic
11	Bencsik & Machova (2016)	Knowledge sharing problems from the viewpoint of intergeneration management	2016	United Kingdom
12	King, Murillo & Lee (2017)	The effects of generational work values on employee brand attitude and behavior	2017	United Kingdom
13	Winadi, Suzianti & Ardi (2018)	Knowledge management in the multi-generation workforce: success factor and strategy	2018	France

14	Bidian & Evans (2018)	Examining inter-generational knowledge sharing and technological preferences	2018	United Kingdom
15	Heyns & Kerr (2018)	Generational differences in workplace motivation	2018	South Africa
16	Lowell & Morris (2019)	Generational attitudes and preferences toward learning and technology	2019	United States
17	Suomaki, Kianto & Vanhala (2019)	Work engagement across different generations in Finland	2019	United States

## 4 RESULTS

### 4.1 Obstacles to knowledge sharing between generations

The differences in thinking of each age group, its attitude, behaviour and value system, flexibility and technical knowledge can easily become a source of many conflicts and ultimately delay the process of knowledge sharing within the company (Bencsik, Horváth-Csikós & Juhász, 2016). It is sometimes very difficult to meet these challenges, the most common of which are: (a) negative stereotypes; (b) the lack of mutual respect and desire to achieve common organizational goals; (c) communication style between generations; (d) generation gap and knowledge loss; (e) morale decline.

According to Brown & Barnett (2017) older workers (Silent Generation, Baby Boomers) often perceive younger generations as entitled, lazy and obsessed with technology, and may also feel as if Millennials and Generation X are attacking the system and are generally difficult. On the other hand, Millennials and Generation Z perceive older workers as refusing to adopt new and innovative ways to think and do things. The survey conducted by ASTD (2014) confirmed that two generations, namely Baby Boomers and Millennials, demonstrate the greatest difficulties in working together: they feel that the opposite generation rejects their past experiences or lacks concentration and discipline. Bursch and Kelly (2014) in their study of the negative stereotypes between generations have identified Generation X considers Baby Boomers as resistant to change, dogmatic in their thinking, sexist and they lack creativity, and Generation Y to be arrogant. In contrast, Millennials evaluates the representatives of Generation X as having a slow response and poor problem-solving capability. Another study (Heyns & Kerr, 2018) has emphasized that Baby Boomers feel the young generations do not work as hard as they do.

Different communication styles between generations may also become a source of many workplace conflicts. The last studies (Bidian & Evans, 2018; Heyns & Kerr, 2018; Lowell & Morris, 2019) have shown that Millennials and Generation Z prefer to use e-mail and instant text messaging rather than face-to-face meetings, notes and other more formal communication techniques. It also was mentioned that younger workers use abbreviations, informal language and other colloquialisms that can cause serious communication gaps within the office environment. As a result, Baby Boomers may regard this as disrespectful behaviour or restraint, while the younger generation sees it as a way of speeding up work and maximizing productivity.

Negative stereotypes and prejudices about the characteristics and experiences of different age groups, that persist at work, may prevent employees from recognizing valuable contributions that other people can offer them (Novianto & Puspasari, 2012). When the older generation leaves work, the younger generation may not have the experience necessary to successfully carry out their work beyond technology. Without knowledge transfer, this could cause a loss of integrated dynamic power. Moreover, morale will decline at the workplace if employees do not feel they are on the same side (Brown & Barnett, 2017).

## **4.2 Recommendations to HR managers how to improve the overall efficiency of the generational knowledge sharing**

To make knowledge sharing between different age groups of employees more effective, department heads and human resource managers are designed to provide real-time feedback, training on a personal and organizational level, and follow each employee as an individual who is an integral part of the team (Lowell & Morris, 2019). To this end, some several strategies and procedures might be useful for a significant improvement in the efficiency of the educational process of the multigenerational workforce.

Firstly, adapting learning experience to each employee helps identify the cognitive style and usual learning regime which is preferable to the individual and may vary considerably by employee. What can be effective for one generation, will not necessarily have the same effect for other generations, especially the older generation (Novianto & Puspasari, 2012). The identification of gaps in the knowledge and skills of the staff is required for optimal performance and recommended to be realized through testing (preferable for Millennials and Generation Z) and face-to-face interviews (preferable for Silent Generation and Baby Boomers).

Secondly, utilizing a recognition and remuneration of staff based on their learning outcomes (e.g. gift cards, a day off), gamification and social learning online has the potential to enhance work engagement that resonates with all generations of employees. It should be noted that gamification is less stressful than traditional learning with lectures and formal tests and therefore leads to innovative thinking, reduces resistance to learning, promotes a spirit of competitiveness and teamwork of employees of all ages. Although younger generations are willing to accept digital educational games, some older employees may prefer classroom learning over digital methods. Besides, the older generation of employees may need a good introduction to social learning (newsgroups, blogs, wikis, social networks such as Facebook, LinkedIn, Twitter or YouTube) to make it work for them (Axonify, 2013).

Finally, there are several ways how to stimulate the motivation of members of different generations to share knowledge, such as: creating physically open spaces for informal knowledge exchange at the workplace, supporting social open culture, recognizing skills, proactivity and high personal performance, promoting learning and gamifying the employees' experience and psychological rewarding, such as a sense of connection with others and sharing of common values, success, usefulness, respect and trust, as well as a reputation (Heinilä, 2019). It is also worth noting, that employees who share knowledge under the influence of external motivation, are more responsive to incentives and rewards (for example, empowering an individual) as motivators for knowledge sharing. Employees who share knowledge based on internal motivation believe that sharing knowledge with others increases their knowledge and skills, and also stimulates the development of the organization (Heyns & Kerr, 2018). For this reason, it is critical to keep these people stay motivated in performing their tasks because they can transfer tacit knowledge to less experienced employees.

## **4.3 Creating a culture of knowledge sharing in the workplace**

A clear idea of what makes each generation's skills valuable helps HR managers create a corporate culture through which each age group understands each other better and opens up new perspectives for learning and personal development. Building and maintaining an atmosphere of trust in which collaboration and more flexible forms of knowledge sharing can benefit is considered a key factor in the success and functioning of an organization in the digital environment (Bencsik, Horváth-Csikós & Juhász, 2016).

Colleagues learn much more from themselves than from formal education, which is why it is so important to create a culture of coaching among different age groups of employees (Subramanian, 2017). It was also found that cooperation between the elders and the younger workers in the workplace leads to the increased cognitive performance of older people and will contribute to promoting positive social behaviour and a lack of egocentrism among younger people (Irish Management Institute, 2018).

Mentoring is the most effective learning through doing scenario when mentors offer guidance to other employees in real-life situations that they may encounter in performing their job duties (Lowell & Morris, 2019). Reverse mentoring is a concept whereby younger employees teach senior people, usually in the field of new and emerging technologies. This technique allows senior management to experiment and apply such learning to key business challenges. It is worth noting that reverse mentoring is crucial for older workers who will have to update important skills with age to stay productive and effective at work (Stevens, 2010). Mutual mentoring goes one step further and realizes through the exchange of new knowledge related to old experiences (Irish Management Institute, 2018). For mentoring to be successful, bridging the generation gap and leading to the transfer of knowledge, an attitude of openness in the workplace must be created and maintained that reduces barriers related to status and power.

It is clear that motivation and willingness, communication and cooperation between the sender and the recipient of knowledge significantly influence knowledge sharing. Lack of employee motivation is identified as a major obstacle to successful knowledge sharing, and lack of confidence in colleagues reduces the desire to share their own experience in practice. Close collaboration, informal relationships and activities allow employees of different ages to get to know each other and develop common standards of interaction. This, on the other hand, favours support for joint learning processes (Jurišević Brčić & Mihelič, 2015).

HR practitioners can positively influence the transfer of knowledge by creating conditions and developing formal programs that facilitate interaction, stimulate knowledge sharing and increase the frequency of collaboration among generationally diverse employees. A formal form of knowledge transfer involves classroom training under the guidance of senior workers who promote knowledge sharing between younger and older workers using multimedia tools such as audio and video interviews and storytelling (Stevens, 2010).

## **5 DISCUSSION**

Suomaki, Kianto & Vanhala (2019) in their study of knowledge-intensive organizations have pointed out that work engagement doesn't depend on the generation of employees and in this case generational differences don't play important role. At the same time studies of King, Murillo and Lee (2017) confirmed that individuals may perform the same work in the organization, but still will have different work goals caused by their diverse life experiences, a system of values and accumulated knowledge. In such situation insights regarding their motivation to learning and exchanging experiences are critical. Moreover, another research emphasizes that changes in workplace demographics will inevitably cause difficulties in the knowledge transfer if each generational cohort will not be able to understand and accept the distinctive features of each other (Winadi, Suzianti & Ardi, 2018). It also leads to the fact that taking into account inter-generational differences is imperative to inform sufficient human resource practices (King, Murillo & Lee, 2017).

An important limitation of this paper is the use of the term “chronological age” versus “psychological age” or “social age” to define the generations that can provide a richer understanding of intergenerational preferences (Bidian & Evans, 2018). This paper is also limited by the assumption, that two representatives of one generation are very similar or the

same. It should also be taken into account that members of the same generation may have very different experiences, attitudes and behaviours. Besides, employee motivation and needs change during their working lives (Irish Management Institute, 2018). On the other hand, all employees want the same from their leaders. Members of all generations want to do meaningful work, gain opportunities to learn and develop, achieve work-life balance, receive fair treatment and be respected (Bursh & Kelly, 2014).

Representatives of the Generation Alfa (people born since 2011) are not included in this research because their entry into the labour market is planned after the next 10 years (Horváthová, Bláha & Čopíková, 2016). An interesting aspect to be examined for future research is the introduction of the Generation Alfa into the workforce. A new generation of young employees might have different personal characteristics and attitudes towards learning and sharing their knowledge with colleagues. This, in turn, could generate different implications for human resource management compared to the results presented in this paper.

## 6 CONCLUSION

This paper discusses the main findings observed through the literature review analysis focused on how generational differences in the area of learning and knowledge sharing may influence the human resource practices of organizations. It was interesting to identify that cooperation between different age groups could provide not only conflicts but also positive results for an organization in which HR managers play an important role. In this context, a change in current personnel activities is inevitable. Consequently, the organization must start preparing for these changes in time to be able to fully exploit the knowledge of different generations of employees for the long-term success of the company.

### References

- AI-Asfour, A., & Lettau, L. (2014). Strategies for Leadership Styles for Multi-Generational Workforce. *Journal of Leadership, Accountability and Ethics*, 11(2), 58-69. Retrieved from <https://search-proquest-com.proxy.k.utb.cz/docview/1535387467?accountid=15518>
- ASTD (2014). *ASTD Workforce Development Community of Practice 2014*. Alexandria: American Society for Training and Development.
- Axonify (2013). *Five Must Haves Training for a Multi-generational Workforce*. Retrieved from <https://www.elearningguild.com/sponsored/40/5-training-must-haves-for-a-multi-generational-workforce/>
- Bencsik, A., Horváth-Csikós, G., & Juhász, T. (2016). X and Y Generation at the Workplace. *Journal of Competitiveness*, 8(3), 90-106. doi: 10.7441/joc.2016.03.06
- Bencsik, A., & Machova, R. (2016). *Knowledge Sharing Problems from the Viewpoint of Intergeneration Management*. Paper presented at the International Conference on Management, Leadership & Governance, Kidmore End. Kidmore End: Academic Conferences International. Retrieved from <https://search-proquest-com.proxy.k.utb.cz/docview/1779263275?accountid=15518>
- Bidian, C., & Evans, M. (2018). *Examining Inter-Generational Knowledge Sharing and Technological Preferences*. Paper presented at the European Conference on Knowledge Management, Kidmore End. Kidmore End: Academic Conferences International.

- Retrieved from <https://search-proquest-com.proxy.k.utb.cz/docview/2116816074?accountid=15518>
- Blanchard, N. P., & Thacker, J. W. (2010). *Effective Training: Systems, Strategies and Practices*. Boston: Pearson.
- Brown, S., & Barnett, M. E. (2017). *The Challenges of Managing a Multigenerational Workforce*. Atlanta: CyQuest Business Solutions. Retrieved from <https://cyquesthr.com/wp-content/uploads/2017/03/The-Challenges-of-Managing-a-Multi-Generational-Workforce-White-Paper-1.pdf>.
- Bursch, D., & Kelly, K. (2014). *Managing the Multigenerational Workplace*. Chapel Hill: UNC Kenan-Flagler Business School. Retrieved from <http://execdev.kenan-flagler.unc.edu/blog/managing-the-multigenerational-workplace-0>
- Eurostat (2017). *Population structure by major age groups*. Retrieved from [https://ec.europa.eu/eurostat/statistics-explained/index.php?title=File:Population\\_structure\\_by\\_major\\_age\\_groups,\\_EU-28,\\_2017-80\\_\(%25\\_of\\_total\\_population\).png](https://ec.europa.eu/eurostat/statistics-explained/index.php?title=File:Population_structure_by_major_age_groups,_EU-28,_2017-80_(%25_of_total_population).png)
- Gursoy, D., Maier, T. A., & Chi, C. G. (2008). Generational Differences: An Examination of Work Values and Generational Gaps in the Hospitality Workforce. *International Journal of Hospitality Management*, 27(3), 448-458. doi: 10.1016/j.ijhm.2007.11.002
- Heinilä, R. (2019). *Organizational Knowledge Sharing 101: How to Get Started*. Retrieved from <https://blog.smarp.com/how-can-management-support-organizational-knowledge-sharing>
- Stevens, R. H. (2010). Managing Human Capital: How to Use Knowledge Management to Transfer Knowledge in Today's Multi-Generational Workforce. *International Business Research*, 3(3), 77-83. doi: 10.1.1.956.4595
- Hernaus, T., & Pološki Vokic, N. (2014). Work design for different generational cohorts: Determining common and idiosyncratic job characteristics. *Journal of Organizational Change Management*, 27(4), 615-641. doi: 10.1108/JOCM-05-2014-0104
- Heyns, M. M., & Kerr, M. D. (2018). Generational differences in workplace motivation. *South African Journal of Human Resource Management*, 16(1), 320-329. doi: 10.4102/sajhrm.v16i0.967
- Horváthová, P., Bláha, J., & Čopíková, A. (2016). *Řízení lidských zdrojů. Nové trendy*. Praha: Management Press.
- Irish Management Institute (2018). *The Multigenerational Workforce*. Dublin: IMI. Retrieved from [http://www.imi.ie/media/Multigenerational\\_Workforce\\_IMI\\_Insight.pdf](http://www.imi.ie/media/Multigenerational_Workforce_IMI_Insight.pdf)
- Juriševič Brčić, Ž., & Mihelič, K. K. (2015). Knowledge Sharing between Different Generations of Employees: An Example from Slovenia. *Economic Research-Ekonomska Istraživanja*, 28(1), 853-867. doi: 10.1080/1331677X.2015.1092308
- King, C., Murillo, E., & Lee, H. (2017). The effects of generational work values on employee brand attitude and behavior: A multi-group analysis. *International Journal of Hospitality Management*, 66, 92-105. doi: 10.1016/j.ijhm.2017.07.006
- Kowske, B. J., Rasch, R., & Wiley, J. (2010). Millennials' (lack of) attitude problem: An empirical examination of generational effects on work attitudes. *Journal of Business and Psychology*, 25(2), 265-279. doi: 10.1007/s10869-010-9171-8



- Lendzion, J. P. (2015). Human Resource Management in the system of Organizational Knowledge Management. *Procedia Manufacturing*, 3, 674-680. doi: 10.1016/j.promfg.2015.07.303
- Lowell, V. L., & Morris, J. (2019). Leading Changes to Professional Training in the Multigenerational Office: Generational Attitudes and Preferences toward Learning and Technology. *Performance Improvement Quarterly*, 32(2), 111-135. doi: 10.1002/piq.21290
- Noe, R. (2008). *Employee Training and Development*. New York: McGraw.
- Novianto, O., & Puspasari, D. (2012). Knowledge Management System Implementation in a Company with Different Generations: A Case Study. *Procedia – Social and Behavioral Sciences*, 65, 942-947. doi: 10.1016/j.sbspro.2012.11.224
- Parry, E., & Urwin, P. (2011). Generational differences in work values: A review of theory and evidence. *International Journal of Management Reviews*, 13(1), 79-96. doi: 10.1111/j.1468-2370.2010.00285.x
- Subramanian, K. R. (2017). The Generation Gap and Employee Relationship. *International Journal of Engineering and Management Research*, 7(6), 59-67. Retrieved from [https://www.researchgate.net/publication/321670836\\_The\\_Generation\\_Gap\\_and\\_Employee\\_Relationship](https://www.researchgate.net/publication/321670836_The_Generation_Gap_and_Employee_Relationship)
- Suomaki, A., Kianto, A., & Vanhala, M. (2019). Work Engagement across Different Generations in Finland: A Qualitative Study of Boomers, Yers and Xers. *Knowledge and Process Management*, 26(2), 140-151. doi: 10.1002/kpm.1604
- U. S. Bureau of Labor Statistics (2017). *Employment projections – 2016-26*. Retrieved from <https://www.bls.gov/news.release/pdf/ecopro.pdf>
- Winadi, K. A., Suzianti, A., & Ardi, R. (2018). *Knowledge management in the multi-generation workforce: an investigation on critical success factors and strategy*. Paper presented at the 1st International Conference on Industrial, Electrical and Electronics. Red Hook: Curran Associates. doi: 10.1051/mateconf/201821804010
- Zemke, R., Raines, C., & Filipczak, B. (2000). *Generations at Work: Managing the Clash of Veterans, Boomers, Xers, and Nexters in Your Workplace*. New York: AMACOM.

## Contact information

### Mgr. Anastasiia Mazurchenko

Technical University of Liberec, Faculty of Economics  
 Voroněžská 13, 46001, Liberec, Czech Republic  
 E-mail: [anastasiia.mazurchenko@tul.cz](mailto:anastasiia.mazurchenko@tul.cz)  
 ORCID: 0000-0003-2044-1607

doi: 10.7441/dokbat.2019.068

# HOUSE PRICES: ANALYZING THE EFFECT OF MACROECONOMIC DETERMINANTS

*Aleš Melecký, Siyu Liu*

## **Abstract**

Since 2015, the EU house prices have increased rapidly, especially in V4 countries, Portugal, Iceland, and Ireland. Even though the growth of house prices may have some positive impacts, e.g. increase in wealth of house owners, it endangers future financial stability and housing affordability. This paper analyses the effect of selected macroeconomic determinants on property prices in 15 European countries over the period 2008 - 2018. It not only theoretically discusses the impact of property market supply and demand factors on house prices, but also empirically employs pooled OLS and fixed effect models to quantify the effects. Overall, we can conclude that growth rate of house prices is pro-cyclical, driven significantly by labour market development and population growth and there is a need for coordination of labour market policy, monetary policy and financial stability. Our model may provide useful information for households, investors and financial stability departments in central banks.

*Keywords:* house prices, macroeconomic determinants, panel data model, fixed effects model, EU

## **1 INTRODUCTION**

According to Bilozor and Wisniewsk (2013), house purchases are one of the highest expenditures for individuals and households and are often financed by mortgage, where house serves as collateral. The fluctuations of house prices therefore influence daily lives of people. For corporations, real estates are important parts of corporate assets. A lot of companies obtain loans by pledging their real estates. The research on property market and house prices has always been a significant part of economics research.

In micro aspects, most of researches such as Lamont (1999), Genesove and Mayer (2001), start from the perspective of customers. They consider the impact of a range of factors which influence customers' purchase decisions on house prices. As for macro aspects, researchers pay more attention to the impact of macro indicators on prices and analyse the relationship between property market and macro economy. For instance, Kuang and Liu (2015) studies the relationship between inflation and house price; Maattanen and Tervio (2013) shows the relationship between income distribution and house prices.

The goal of this paper is to analyse the effect of selected macroeconomic determinants on house prices in 15 European countries. Our results may provide additional information to investors and household as well as for financial stability departments in central banks. The structure of this paper is as follows. Section 2 introduce selected macro factors that affect house prices. Section 3 describes our data and methodology. Section 4 discusses the empirical results. The last section concludes.

## **2 DETERMINANTS OF PROPERTY PRICE**

Hejllova, Hlavacek and Komarek (2017) uses a housing supply and demand model to assessing equilibrium residential property prices in Czech Republic. We can also think of demand and supply side factors which may determine property prices.

When it comes to supply side, the first thing we need to consider is its cost. The cost of property is one of the most important factors affecting the housing market and consists of the following components: price of lands, administrative expenses, costs of construction, costs of materials, interest expenses of loans, taxes and other expenses. All parties on supply side have to ponder the impact of costs. For example, property developers bear most of above costs, and they must estimate their affordable costs when they develop properties. When price of selected lands or other costs are higher, developers may adjust their supply of properties. Second-hand house transfers mainly bear administrative expenses and transaction costs.

Then, expectations are also important for supply of property, specifically the outlook of suppliers such as expected land costs, production costs, inflation, interest rates, consumers' preferences, etc. For instance, if property developers expect that price of land in a certain area where they plan to build would increase in the future, they are more likely to choose purchasing the land now and will include the expected cost increase in the final price

As for demand side, the demographic factor is the most vital factor affecting housing demand. The establishment of new families, population growth, and expansion of family size will lead to a change in demand for residential properties.

Wages and salaries are significant factors influencing demand of households. As a rule, income is positively correlated with residential demand. When people receive higher wages, they are more likely to move to a better place. For instance, instead of renting a house, people can afford to buy their own house, or current house owners may buy a bigger house. Therefore, rising demand increase house prices. However, due to large differences in economic levels of different regions, the impact of income on house prices differ.

Englund and Ioannides (1997) suggests that national policy changes may also have a major impact. The direct impacts of policy indicate that the direct goal of national policy is to regulate real estate prices. For example, to curb the rise in property prices, China has introduced a more stringent bank lending policy and increased the down payment ratio of second homes. This measure should restrain investment-oriented consumers, and thereby control the irrational rise in house prices. The indirect impacts of national policies refer to policies that do not target the real estate market but affect prices of real estate. For instance, when central banks conduct a series of operations to influence the money supply and interest rates, they do not primary aim at property market, but these polices affect house prices.

In this paper, we choose house price index as dependent variable. Our six independent variables capture mostly demand side and include CPI (Consumer Price Index) inflation, GDP (Gross Domestic Product), population, unemployment rate, wages, and interest rate. Our aim is to analyse how these drivers influence house prices.

### **3 DATA AND METHODOLOGY**

#### **3.1 Data**

The dependent variable is house prices index. According to Eurostat (2019), house price index reflects price changes of all residential properties purchased by households. The data are expressed as quarterly index (2015=100). Units of GDP and wages are both million euro. GDP is calculated by expenditure approach. Population is for thousand persons. Interest rate is the long-term interest rate approximated by ten-year government bond yield. Data of CPI inflation, house price index and GDP are from OECD (2019). Other data come from Eurostat (2019). All these data are in quarterly frequency. Data cover the period from the fourth quarter of 2008 to

the third quarter of 2018, i.e. 40 periods, and in total 600 observations. Details are shown in Tab.1.

Tab. 1 – Descriptive data. Source: own research

Variable		Mean	Std. Dev.	Min	Max	Observations
House price	overall	101.2638	15.5443	63.88	168.0575	N = 600
	between		8.740909	88.9715	121.906	n = 15
	within		13.04593	74.32258	147.4152	T = 40
CPI	overall	1.239576	1.318307	-6.12777	5.533818	N = 600
	between		.4753793	.0577659	2.1175	n = 15
	within		1.235581	-4.94596	5.955927	T = 40
GDP	overall	213997.1	221528.9	9030.6	851231	N = 600
	between		227263.1	11847.77	722846.1	n = 15
	within		28094.16	96858.5	342382	T = 40
Population	overall	26813.17	27096.89	492.98	82926	N = 600
	between		28019.71	548.957	81210.38	n = 15
	within		504.0323	24516.39	29045.39	T = 40
Unemployment	overall	9.571833	5.395168	3.4	27.7	N = 600
	between		5.047922	5.2625	20.86	n = 15
	within		2.298996	-2.985667	16.71433	T = 40
Wages	overall	81519.02	88303.04	4042.3	361020	N = 600
	between		90563.2	5028.105	297330.9	n = 15
	within		11390.08	34623.12	145208.1	T = 40
Interest rate	overall	2.947033	2.96501	-.12	25.4	N = 600
	between		2.151186	1.49075	9.78325	n = 15
	within		2.113049	-2.766217	18.56378	T = 40

### 3.2 Methodology

The main sources for this section are from Maddala (2001), Wooldridge (2002), Gujarati (2003), and Brooks and Tsolacos (2010). Since we need to study the relationship between macroeconomic determinants and property prices across the time and countries, we employ panel data analysis to specify the relationship between house prices and selected variables.

In our model, panel data form long panel, which means that we have more time periods than countries ( $N < T$ ). First we should test the stationarity of our data. Because stationary time series are more likely to help us to figure out a permanent, rather than temporary, rule between the dependent and independent variables.

To check the stationarity of our data, we use Levin-Lin-Chu test.

$$y_t = \alpha y_{t-1} + \varepsilon_t, |\alpha| < 1 \quad (1)$$

Where  $y_t$  is variable, which we test,  $\alpha$  is the root, and  $\varepsilon_t$  is the error term. The null hypothesis is  $\alpha = 1$ , which means panels contain unit roots. The alternative hypothesis is  $\alpha < 1$ , which means panels are stationary. We estimate two types of panel data models - the pooled regression

model, and the individual-specific effects model. The key assumption of pooled regression model is that there are no unique attributes of individuals within the measurement set, and no universal effects across time. This regression model specifies constant coefficients, referring to both intercepts and slopes.

$$y_{it} = c + x_{it}\beta + u_{it}. \quad (2)$$

Where  $y_{it}$  is the dependent variables observed for individual  $i$  at time  $t$ ,  $c$  is the unobserved constant coefficient,  $\mathbf{x}_{it}$  is the time-variant  $T \times k$  (the number of independent variables) regressor matrix,  $\beta$  is the  $k \times 1$  matrix of parameters, and  $u_{it}$  is the error term.

If there is no significant difference between different individuals in terms of time; for the cross-section, there is no significant difference between different sections, then we can directly use pooled ordinary least squares (OLS) to analyze this model.

OLS is a type of linear least squares method for estimating the unknown parameters in a linear regression model. The pooled OLS estimator is generated by stacking the data over  $i$  and  $t$  into one long regression with  $N \times T$  observations and estimating it by OLS.

$$y_{it} = \beta_0 + \beta_1 x_{it} + \beta_2 x_{it} + \dots + \beta_k x_{it} + u_{it}. \quad (3)$$

Where  $\beta_k$  is the  $k \times 1$  matrix of parameters, and  $k$  is the number of independent variables. This model appears overly restrictive because  $\beta$  is the same in each time period.

The individual-specific effects are the leftover variation in the dependent variables that cannot be explained by the regressors. We assume that there is unobserved heterogeneity across individuals generated by  $c_i$  ( $i$  means different individuals).

There are two common assumptions which are made about the time-invariant individual effects  $c_i$ . They are the random effects assumption and the fixed effects assumption. The random effects assumption (made in a random effects model) is that the individual-specific effects are uncorrelated with the independent variables. The fixed effects assumption (made in a fixed effects model) is that the individual-specific effects are correlated with the independent variables.

The fixed effects (FE) model allows the individual-specific effects to be correlated with the regressors  $x$ . We include  $c_i$  as intercepts. Hence, each individual has a different intercept term and the same slope parameters.

$$y_{it} = c_i + x_{it}\beta + u_{it}. \quad (4)$$

Since  $c_i$  is not observable, it cannot be directly controlled for.

#### **4 EMPIRICAL ANALYSIS OF MACROECONOMIC DETERMINANTS OF PROPERTY PRICES**

We choose 15 European countries (EU15) to proceed our analysis. They are Austria, Belgium, Denmark, Finland, France, Germany, Greece, Ireland, Italy, Luxembourg, Netherlands, Portugal, Spain, Sweden, and United Kingdom.

We choose EU15 because it is quite homogenous and standardly used group of countries. Even if there is some heterogeneity among this countries with respect to conditions for buying, law, culture etc., it should be mostly captured by the fixed effects that we use in our models.

## 4.1 Stationarity of data

According to the last section, we use Levin-Lin-Chu test to detect stationarity of our data. Based on the analysis in STATA, we get the following results.

Tab. 2 – Summary of LLC test. Source: own research

Variable	P-value	Result
House price index	0.9941	Non-stationary
CPI inflation	0.0000	Stationary
GDP	0.9953	Non-stationary
Population	0.0694	Non-stationary
Unemployment rate	0.7903	Non-stationary
Wages	1.0000	Non-stationary
Interest rate	0.0041	Stationary

In this test, we want to reject the null hypothesis and accept the alternative hypothesis. According to this table, except CPI inflation and Interest rate, the other p-values are higher than 5%. These variables are non-stationary. We stationarized them by calculating annual growth rates. As a result, all of the time series are stationary now.

## 4.2 Model estimation

In the real world, not all changes in independent variables will immediately affect the dependent variable. For instance, when our wage increases, we will not buy house immediately. We are more likely to wait until the wages rise steadily for a while before we consider buying a house. Therefore, we consider various time lags (L) of independent variables.

We begin with pooled OLS method to estimate the model. We present the results of three most promising models selected from all tested alternatives. The estimations based on pooled OLS are named Model 1, Model 2, and Model 3. We provide the results in tables below.

Tab. 3 – Model 1 (pooled OLS model). Source: own research

Number of obs	480	Prob > F	0.00
F (6, 473)	107.67	Adj R-squared	0.57
GR_House price index	Coefficient	t	P> t
CPI inflation	-0.46	-2.89	0.004
GR_GDP	0.17	3.76	0.000
GR_Population	2.06	6.15	0.000
GR_Unemployment rate	-0.19	-9.41	0.000
GR_Wages	0.21	4.12	0.000
Interest rate	-0.32	-4.11	0.000
Constant	1.20	2.53	0.012

In Model 1, there are no lags in CPI inflation, growth rate of GDP, growth rate of population and growth rate of unemployment rate. There are four lags in growth rate of wages and level of interest rate.

Tab. 4 – Model 2 (pooled OLS model). Source: own research

Number of obs	450	Prob > F	0.00
F (6, 443)	112.72	Adj R-squared	0.60
GR_House price index	Coefficient	t	P> t
CPI inflation	-0.66	-4.19	0.000
GR_GDP	0.19	4.22	0.000
GR_Population	2.10	6.29	0.000
GR_Unemployment rate	-0.19	-9.70	0.000
GR_Wages	0.27	5.35	0.000
Interest rate	-0.22	-2.81	0.005
Constant	1.07	2.33	0.020

In Model 2, one lag is in CPI inflation and growth rate of unemployment rate. No lags are in growth rate of GDP and growth rate of population. Six lags are in growth rate of wages and four lags are in interest rate.

Tab. 5 – Model 3 (pooled OLS model). Source: own research

Number of obs	450	Prob > F	0.00
F (6, 443)	102.96	Adj R-squared	0.58
GR_House price index	Coefficient	t	P> t
CPI inflation	-0.83	-5.22	0.000
GR_GDP	0.15	3.37	0.001
GR_Population	1.87	5.40	0.000
GR_Unemployment rate	-0.20	-9.38	0.000
GR_Wages	0.25	4.79	0.000
Interest rate	-0.24	-3.06	0.002
Constant	1.68	3.65	0.000

In Model 3, one lag is in CPI inflation and growth rate of GDP. Two lags are in growth rate of population and growth rate of unemployment rate. Six lags are in growth rate of wages and four lags are in interest rate.

All presented models fit the data well ( $\text{adj}R^2$  is around 0.6). Because of different lags, models have different observations and R-squared. Model 2 has the highest R-squared value 0.60. The effect of CPI inflation on house price index growth ranges from -0.83 to -0.46. The effect of GDP growth ranges from 0.15 to 0.19. The effect of population growth ranges from 1.87 to 2.10. The effect of unemployment rate growth ranges from -0.20 to -0.19. The effect of wages growth ranges from 0.21 to 0.27. The effect of interest rate ranges from -0.32 to -0.22. The effects of all independent variables are statistically significant at 1% level.

As a second step, we estimate fixed effect models with the same sets of lags, and we label them Model 4, Model 5, and Model 6.

Tab. 6 – Model 4 (FE model). Source: own research

Number of obs	480	Prob > F	0.00
F (6, 459)	93.16	R-squared: overall	0.51
GR_House price index	Coefficient	t	P> t
CPI inflation	-0.63	-4.10	0.000
GR_GDP	0.20	4.95	0.000
GR_Population	5.98	8.02	0.000
GR_Unemployment rate	-0.19	-9.66	0.000
GR_Wages	0.14	3.08	0.002
Interest rate	-0.35	-3.61	0.000
Constant	-0.46	-0.75	0.452

Tab. 7 – Model 5 (FE model). Source: own research

Number of obs	450	Prob > F	0.00
F (6, 459)	92.74	R-squared: overall	0.55
GR_House price index	Coefficient	t	P> t
CPI inflation	-0.84	-5.26	0.000
GR_GDP	0.21	4.98	0.000
GR_Population	5.41	7.05	0.000
GR_Unemployment rate	-0.18	-9.06	0.000
GR_Wages	0.20	4.38	0.000
Interest rate	-0.23	-2.22	0.027
Constant	-0.27	-0.44	0.662

Tab. 8 – Model 6 (FE model). Source: own research

Number of obs	450	Prob > F	0.00
F (6, 443)	77.18	R-squared: overall	0.57
GR_House price index	Coefficient	t	P> t
CPI inflation	-1.04	-6.24	0.000
GR_GDP	0.16	3.55	0.000
GR_Population	3.29	4.14	0.000
GR_Unemployment rate	-0.18	-8.60	0.000
GR_Wages	0.19	3.91	0.000
Interest rate	-0.29	-2.61	0.009
Constant	1.47	2.34	0.020

In these models, the effect of CPI inflation on house price index growth ranges from -1.04 to -0.63. The effect of GDP growth ranges from 0.16 to 0.21. The effect of population growth ranges from 3.29 to 5.98. The effect of unemployment rate growth ranges from -0.19 to -0.18. The effect of wages growth ranges from 0.14 to 0.20. The effect of interest rate ranges from -0.35 to -0.23. They are all statistically significant at 1% level, except the effect of the interest rate in Model 5, which is significant at 5% level.

All six models provide reasonable results. Model 6 is our preferred choice as it has the high explanatory power, all effects of independent variables in this model are statistically significant at 1% level, and it takes into account individual-specific effects.

Our results suggest that CPI inflation and GDP growth affect the house prices growth with one period lag. Rather shorter lag may be the result of households' reactions to GDP growth forecasts, which are often reported in the news. The same applies to inflation as the central banks nowadays regularly informs the households about inflation development and its forecast. Therefore, households can reflect this information into their demand for properties soon.

There are many reasons for strong positive effect of population growth on house prices growth in a country. For example, when a baby is born, parents are more likely to move from a small apartment to a bigger property. However, it takes some time to find and buy a house. Another example is the increased immigration. When immigrants arrive in a new country, they need to know a lot of information and handle a lot of things before finding proper living. However, when they have already settled down, they need a property soon. Hence, the effect of population growth on the house prices growth is delayed but time lag is not so long.

Two period lags are found in unemployment rate growth. Compared to the effect of GDP growth and CPI inflation. It takes a bit more time before the effect of unemployment rate growth transmits to the house prices growth. Further, people that are unemployed for longer time may start to sell their properties, which will increase the supply on the market and decrease the growth of property prices.

Our results suggest positive effect of wages growth with a long lag (six periods). As we have discussed before, when our wages just start to increase, we will not buy a house immediately. We are more likely to wait for a steadily increase lasting for one or two years.

The same applies for interest rate effect. When interest rate falls, most people will wait for a while if it falls further or not before taking a loan to finance property or before altering their portfolio investments.

### 4.3 Summary of models

We can find that our results are robust as signs of all independent variables corresponds across the presented models. CPI inflation is negatively correlated with our dependent variable. This might seem counter intuitive at the first look, but we explain that this finding is in line with



economic theory a follow. When inflation grows, people spend more on ordinary goods and services. Therefore, they do not have enough money to afford a house. It reduces their purchasing power and reduces the demand for property. House prices growth may therefore decrease. We find a positive effects of GDP growth and growth of wages on house prices growth. It is reasonable. Growing GDP and higher wages make people richer and demand for the properties increases. The effect of population growth on house prices growth is positive which is in line with our suggestion. When population increases, people will purchase more houses and house prices growth will increase.

Growth rate of unemployment rate is negatively correlated with our dependent variable. When people lose jobs, they do not have incomes and they cannot spend much money on houses. House prices growth will therefore decrease. Interest rate development is negatively correlated with house prices growth. When interest rate increases, it is harder for people to repay their loans and fewer people can afford to buy a house.

## 5 CONCLUSION

In this paper, we use panel data regression model to study the effects of macroeconomic drives of house prices growth on sample of 15 European countries over the period from the fourth quarter of 2008 to the third quarter of 2018. The independent variables include CPI inflation, GDP growth, population growth, growth of unemployment rate, wages growth and interest rate. We present the results of six models estimated by the pooled OLS and fixed effect methods. These models where selected based on statistically significance, explanatory power and consistency with economic theory. According to our preferred model (Model 6), inflation and GDP growth influence the house prices growth faster than the development of labour market, population changes and interest rate policy. Our estimates suggest that increase in wages is reflected in house prices growth only after six periods. The lag reactions of property prices to presented determinants is reasonable. People usually do not decide based on forecasts of key determinants when they need to buy a property. And even if they do, which might be the case of GDP growth and inflation, it takes some time before the intention changes into reality.

We conclude that house prices are pro-cyclical and that financial stability may be significantly affected by monetary policy setting and labour market development. Pressures on salary growth as well as migration may therefore accelerate property price growth.

In further research, we would like to apply GMM method and enlarge the model by adding more variables from the supply side. In the future, we may also study the effect of crisis and different groups of countries.

## Acknowledgement

This paper was financially supported within the VŠB–Technical University SGS grant project No. SP2019/119 (Econometric Modeling of Fiscal, Monetary and Financial Aspects of the European Economies).

## References

Bilozor, M. R., & Wisniewsk, R. (2013). The Impact of Macroeconomic Factors on Residential Property Price Indices in Europe. *Folia Oeconomica Stetinensia*, 12(2), 103-125. doi: 10.2478/v10031-012-0036-3

- Brooks, C., & Tsolacos, S. (2010). *Real Estate Modelling and Forecasting*. Cambridge: Cambridge University Press.
- Englund, P., & Ioannides, Y. M. (1997). House Price Dynamics: An International Empirical Perspective. *Journal of Housing Economics*, 6(2), 119-136. doi: 10.1006/jhec.1997.0210
- Eurostat (2019). *Eurostat Database*. Retrieved from ec.europa.eu/eurostat/data/database
- Genesove, D., & Mayer, C. (2001). Loss Aversion and Seller Behavior: Evidence from the Housing Market. *The Quarterly Journal of Economics*, 116(4), 1233-1260. doi: 10.1162/003355301753265561
- Gujarati, D. N. (2003). *Basic Econometrics*. New York: McGraw-Hill.
- Hejlova, H., Hlavacek, M., & Komarek, L. (2017). A Comprehensive Method for House Price Sustainability Assessment in the Czech Republic. *Prague Economic Papers*, 26(3), 269-285. doi: 10.18267/j.pep.613
- Kuang, W., & Liu, P. (2015). Inflation and House Prices: Theory and Evidence from 35 Major Cities in China. *International Real Estate Review*, 18(2), 217-240. Retrieved from [http://www.umac.mo/fba/irer/papers/current/vol18n2\\_pdf/03.pdf](http://www.umac.mo/fba/irer/papers/current/vol18n2_pdf/03.pdf)
- Lamont, O. A. (1999). Economic Tracking Portfolios. *NBER Working Paper No. 7055*. Retrieved from <https://ssrn.com/abstract=157772>
- Maddala, G. S. (2001). *Introduction to Econometrics*. New York: Wiley.
- Maattanen, N., & Tervio, M. (2013). Income Distribution and Housing Prices: An Assignment Model Approach. *Journal of Economic Theory*, 151, 381-410. doi: 10.1016/j.jet.2014.01.003
- OECD (2019). *OECD iLibrary: Economics*. Retrieved from [www.oecd-ilibrary.org/economics](http://www.oecd-ilibrary.org/economics)
- Wooldridge, J. M. (2002). *Econometric Analysis of Cross Section and Panel Data*. London: MIT Press.

## Contact information

### Ing. Siyu Liu

VSB – Technical University of Ostrava, Faculty of Economics  
 Sokolská třída 33, 70200, Ostrava, Czech Republic  
 E-mail: [siyu.liu.st@vsb.cz](mailto:siyu.liu.st@vsb.cz)  
 ORCID: 0000-0002-0331-377X

### doc. Ing. Aleš Melecký, Ph.D.

VSB – Technical University of Ostrava, Faculty of Economics  
 Sokolská třída 33, 70200, Ostrava, Czech Republic  
 E-mail: [ales.melecky@vsb.cz](mailto:ales.melecky@vsb.cz)  
 ORCID: 0000-0002-4495-6296

doi: 10.7441/dokbat.2019.069

# THE BENEFITS THAT CREATIVE INDUSTRIES CAN OFFER TO COUNTRIES CAUGHT IN MIDDLE INCOME TRAP

*Peter Mičák*

## **Abstract**

Middle-income trap is a problem that affects a large number of countries, especially in South America, Africa and East Asia. The causes of this problem are multiple, whereas common characteristics of these countries are the lack of innovation and research & development that makes them unable to compete with the more advanced high-income countries, while at the same time increasing labour costs, which make these countries lose competitiveness against low-income countries. The scientific aim of the article is to point out the possible benefits that these countries could achieve through the incorporation and systematic promotion of Creative industries. Methodologically, the article is based on a literature review of relevant scientific articles in the field of the Middle-income trap and Creative industries. Based on this research, the underlying problems of countries caught in the Middle-income trap were identified. These main shortcomings were then contrasted with the benefits that the Creative industries could deliver. As a result, the paper is an attempt at filling the research gap by pointing out that Creative industries have the potential to significantly counterbalance the difficulties that these countries are challenged with, particularly in terms of innovation, research and development, improving employment and raising the standard of living of their citizens.

*Keywords: middle-income trap, creative industries, innovation, research and development, economic growth*

## **1 INTRODUCTION**

Middle-income trap is an ambiguous term, and although it is the subject of active debate among economists and researchers, and is known for over ten years, there is not yet a clear definition (Yao, 2015). One of the undesirable consequences is that many studies use their own theoretical framework. Notwithstanding the great interest of economists, who have been able to identify many of the problems that are causing this phenomenon and even suggested many solutions, it is still challenging to move research forward (Doner & Schneider, 2016).

One can encounter a similar problem in the Creative industries, whose ambiguous and fragmented definition causes many challenges in their research (Kloudová & Chwaszcz, 2014), although the situation in Creative industries is not as dramatic as is the case of the Middle-income trap. For example, the reader may encounter the concepts of cultural industries, creative industries or even the knowledge economy, but they are mostly synonymous words for the same thing (Banks & O'Connor, 2009). Efforts to change this fragmentation, of course, exist, many multinational organizations have come up with their definition or theoretical framework to unify the definition of Creative industries. Examples are European Commission, UNESCO (United Nations Educational, Scientific and Cultural Organization), WIPO (World Intellectual Property Organization), UNCTAD (United Nations Conference on Trade and Development) and OECD (Organization for Economic Cooperation and Development) (Cunningham, 2009). Nevertheless, there are still considerable differences in the perception of creative industries at a national level, even among states that have a relatively similar structure of the economy and are to some extent harmonized, such as the Member States of the European Union. This is because the needs of each country are somewhat different, and therefore it is not possible to

implement a uniform methodology for Creative Industries across all countries. What this increased interest of academics, multinational organizations, states and their representatives, or even directly of participants and entrepreneurs in the Creative Industries has brought is a general consensus on the ever-increasing importance of these industries. However, in the case of the Middle-income trap, some entirely negative attitudes call into question the existence of this phenomenon. For example, Felipe, Kumar and Galope (2017) in their work, reject the existence of the Middle-income trap as a generalized phenomenon. They argue by the abovementioned absence of a relevant definition of this phenomenon and by the academic inability to provide a theoretical framework and studies that would confirm the existence of this phenomenon. Regardless of the controversy of this term, it is clear that several middle-income countries have problems with prolonged slow growth, stagnation or worse, recession or depression. The link between the benefits of Creative industries and countries caught in the Middle-Income trap has not been researched yet. The article aims to point out the possible benefits of acknowledging and promoting Creative industries, which are described in the context of countries caught in the Middle-income trap. In the following chapters, the main problems that middle-income countries face are linked with selected benefits that Creative industries could offer to these middle-income countries.

## **2 ACCELERATION OF GROWTH AND ITS BARRIERS**

Felipe, Kumar and Galope (2017) argue that it is clear that some countries or groups of countries will grow faster than others and will manage the transition to high-income countries more quickly. Nations that find themselves in the Middle-income trap have difficulty maintaining their competitiveness with developed countries whose economies are based on innovation. At the same time, they are not able to compete with low-income countries that are causing premature deindustrialization of middle-income countries because of higher labour costs of their population compared to low-income countries (Doner & Schneider, 2016). However, if countries do not have the necessary infrastructure to compete with developed countries through innovations and their workforce is not cheap enough to compete with developing countries, it is in their interest to be able to tap the potential of their population. Skavronska (2017) claims that creativity is an inexhaustible raw material based on ideas and cultural characteristics. The source of creativity is abstract and includes everything an individual has, whether knowledge, emotion, talent, spontaneity, intuition, memories, imagination, the ability to create new and original ideas, the ability to solve problems, along with culture, values and traditions. That is why creativity is distributed relatively evenly across countries and is, therefore, one of the ways to boost the economy against international competition.

There are two basic methods in the literature for classifying a country within the middle-income zone. The first method is absolute, where the exact limits of national income per capita are established, and if the country falls within them, it is a middle-income country. The second is the relative method, where national income per capita is compared with the income percentage of a high-income country. The pace of economic growth is, consequently, the most crucial indicator of the ability to converge to a high-income country. Up to 80% of the middle-income countries remained at this level or fell into low-income countries during the 20-year researched period. Only five states have managed to maintain average annual GDP growth of 5.2% or more over the past 50 years, including China, Botswana, Singapore, South Korea and Equatorial Guinea (Yao, 2015).

Doner and Schneider (2016) emphasized in their work that today's high-income countries of Western Europe, North America and East Asia could rely on mass production as the accelerator of their growth. Countries that want to escape the Middle-income trap now have it harder

because they struggle with low-income countries for production and their economic trajectory towards higher income will differ significantly in the 21st century from the 20th century. This is also confirmed by Ito (2017), who claims that most Asian countries, which in the past decades grew faster than economies in other regions, followed a similar trajectory from low-income through middle-income to high-income via industrialization. At present, however, the growth rate of several Asian countries is slowing compared to advanced economies, and there is a risk that they will never be able to reach the income level of developed countries. One of the other causes besides the loss of competitiveness caused by long-term stagnation or economic downturn is the fact that middle-income countries are significantly more vulnerable to financial crises, which they also suffer from more often (Yao, 2015).

### **3 THE NEED FOR INNOVATION AND THE BENEFITS OF DEVELOPING CREATIVE INDUSTRIES**

Gouvea and Vora (2018) point out that the possibility of falling into the Middle-income trap and the inability to reach higher levels per capita income is realistic for countries that ignore the need of investing resources in research & development projects and innovation. These countries will be less able to cope with the modern global challenges of convergence, digitization and globalization and may eventually become the victims of creative divide against countries that actively support the development of innovative services and goods. Addressing these needs by representatives of the people by promoting the development of Creative industries entails, besides innovation, the creation of new jobs. These newly created jobs brought by Creative industries have on average higher wages, which are spent in the region, thus supporting its economy (Kloudová & Chwaszcz, 2014). Jones et al. (2016) add that the growth of Creative industries is dependent on continuous innovation. The main factors that positively influence the growth of Creative industries are expenditures for culture, creativity index, government expenditures for culture, number of patents, the employment rate in research and development, number of students enrolled in arts and humanities and tolerance index. Factors with weaker influence are mainly employment in Creative industries, the exports of the Creative industries sector, government expenditures for research and development and inhabitants with high education (Martinaitytė & Kregždaitė, 2015).

A key feature for countries caught in the Middle-income trap is their GNI per capita growth rate. For example, if a country wants to increase GNI per capita 12.5 times, it will take 64 years with an average growth rate of 4%, 84 years with an average growth rate of 3%, 127 years with an average growth rate of 2% and 253 years with an average growth rate of 1% (Yao, 2015). It is the Creative industries that appear to be an ideal source of accelerating economic growth and a source of innovation. Flew and Cunningham (2010) emphasize that Creative industries are increasingly at the centre of the economic interest of developed countries, as their development brings innovations, increased employment and the development of a knowledge-based society. Moreover, their economic importance is gradually increasing over time (Kloudová & Chwaszcz, 2014). Lampel and Germain (2015) go so far as to claim that the importance of Creative industries is unquestionable and can already be seen as the hub of innovation for the 21st century.

The Creative industries have gradually transformed from the artistic creation of the individual to an industry mass-producing products and services. Of course, with increasing size, the Creative industries are creating positive spillover effects, either in terms of driving innovation, attracting educated and experienced workers or investors in areas where Creative industries are thriving (Purnomo & Kristiansen, 2017). Zelazny and Pietrucha (2017) perceive the creative economy as an economy that is the result of feedback between institutions, human capital and

technological conditions that facilitate the development of creativity, which accelerates innovation. The results of economists' research by Protogerou, Kontolaimou and Caloghirou (2017) confirmed that companies operating in the Creative industries outperform companies outside this sector in the areas of product innovation and research & development intensity. Ito (2017), a researcher of the Middle-income trap, comes with an interesting suggestion in the form of an expanded scheme identifying innovations as a crucial driver for increasing the country's income. Given the limited sample of countries, the proposed model should be considered as suggestive evidence rather than a verifiable hypothesis.

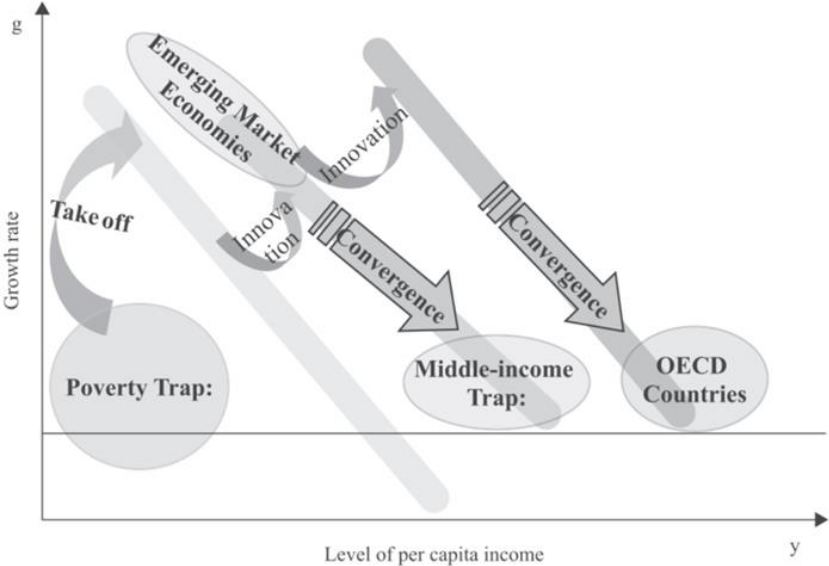

Fig. 1 – Crucial role of innovation. Source: Ito (2017)

**4 PUBLIC POLICIES**

According to Doner and Schneider (2016), a significant problem for middle-income countries is the difficulty and complexity of policy change that would require a robust political coalition capable of coordinating the fragmented interests of individual groups, often combined with low demand for such changes from the public. There are many structural obstacles, but above all are the political barriers, such as the creation of the necessary institutions, reforms of education, the judiciary and financial systems and new policies that can support and motivate the public and private sector towards the knowledge economy. The advantage seems to be a stable government, sometimes even with authoritarian inclinations that can enforce the necessary changes in society. Ito (2017) recalls that both the Republic of Korea and Singapore have had a stable government in their boom that promoted industrial policies, through the support of specific sectors. Yao (2015) even openly admits that China must strive to eliminate the risk of financial crises by preventing liberalisation. Promoting tolerance and diversity is a traditional prerequisite for the development of Creative industries, but as it turns out, this is not valid for all countries. Creative industries are also thriving in countries like the People's Republic of China and Singapore, where governments strictly control many aspects of their citizens' lives and often censor artists (Silvio, 2018).

By identifying priorities for socio-economic development using relevant policies, the state can effectively support Creative industries, whether at national, regional or local level. Creative sectors offer a range of already mentioned benefits, whether by creating jobs, bringing innovations, or increasing productivity. State support for Creative industries is especially crucial at the time of their creation (Drab-Kurowska, 2018). The policies for helping to establish

and develop Creative industries are mainly tax breaks, export support, support for cooperation between the private sector and educational institutions, or business support, and many others (Jürisson, 2007). As Porfirio, Carrilho and Mónico (2016) point out in their paper, institutional support for entrepreneurship can balance the inadequacies in the market and therefore, provide financial and human resources to new entrepreneurial ventures in less mature markets. Doner and Schneider (2016) argue that the significant problem is, in particular, improving education and supporting research and development. Creating a simple primary education in a country, which is still a challenge on its own, especially for low-income countries, is much easier than creating a high-quality infrastructure of universities and research centres. The need for appropriate education is crucial to the success of the Creative industries, but even in western countries, the educational process has often failed to prepare creative workers for their work in Creative industries. Research has shown that general human capital is more important to creative employees and their careers than specific human capital. This is a vital aspect to be taken into account by educational institutions, as most creative employees are reporting dissatisfaction with their initial education that did not adequately prepare them for the work they performed (Hennekam & Bennet, 2016).

Progressive cultural policies and the implications of their implementation need to be explicitly and unequivocally justified. They cannot be subjected to pure criticism or acceptance of economic logic (Banks & O'Connor, 2009). At the same time, it is necessary to continuously measure and evaluate Creative industries and select the right indicators, which is a complex process that has to be continuously updated to meet current needs (Castro-Higueras & Aguilera-Moyano, 2018). From the point of view of public policy creation, they can be created from several perspectives, they can support the localisation of Creative industries in certain areas, or they can support the development of Creative industries in different regions. These two strategies are by no means exclusive to each other. At the local level where creative clusters arise, support for their development is beneficial because they can either develop strong areas of Creative industries or encourage the development of those less developed areas of Creative industries (Lazzeretti, Boix & Capone, 2008). In most countries, the development of these policies is the responsibility of a public entity that was previously responsible for the protection and development of culture. The combination of market-oriented Creative industries and many times, elitist cultural policies can lead to the creation of a fragile and confusing system. This proves to be particularly true in transitional economies that have not yet had much experience in a market economy (Jürisson, 2007). Skavronska (2017) adds that Creative industries are a mixture of socio-cultural practices with an integrating creative component that often borders with experiment and innovation and therefore, does not always follow commercial objectives.

Based on experience from around the world, it is possible to identify four basic models of Creative industries that exist; the American model, the European model, the Asian model and the model of Global South. Each of these basic models has a different approach to cultural policies with distinctly local aspects (Cunningham, 2009). It goes without saying that each country will have different starting points and will have different strengths and weaknesses, so, for example, the relatively corporate model of the United States would not work in Europe or Asia with different specifics of the market. Many times public policies focus on encouraging, attracting or cultivating creative employees or creating creative clusters. However, if these policies are not thought through, they may not achieve the anticipated effects or in the worst case, even have adverse effects. For the creation of such policies, it is necessary to understand the needs of creative workers, because only through a sufficient understanding of this specific group can policies that utilise the potential of these individuals be developed (Kong, 2014).

## 5 CONCLUSION

Creative industries are not a miracle panacea for the countries trapped in the Middle-income trap. In most cases, these countries grow slowly or even stagnate due to lower innovation rates compared to developed countries. As mentioned in the article, they are often unable to create a sufficiently strong political coalition to push through the necessary reforms of the business environment, the financial market and especially education, which are essential prerequisites for innovation. Creative industries, in particular, are based on the creativity of the population, which is distributed relatively evenly. It is, therefore, suitable for the country to exploit the potential of its people and to promote the proliferation of Creative industries or creative clusters, which bring with them numerous positive spill-over effects. These spill-over effects have the potential to melt into innovation and economic growth.

At the same time, however, it is essential to realise that the production of Creative industries in many countries is not competitive on the international market, mainly because of the language and cultural barriers. The problem is that in many countries, the number of 'buyers' of cultural products is so low that producers are not able to generate enough sales to make production cost-effective (Jürisson, 2007). Thus, while some products and services have the potential to be global; others may not (Collins, Mahon & Murtagh, 2018). The trend of globalization is still present, and this globalization can increasingly be seen in the areas of innovation or research and development. This is a definite advantage for countries caught in the Middle-income trap because they have the opportunity to learn from the best. Nevertheless, it is increasingly possible to see a return to the sense of locality. As mentioned in the introduction of the article, the concept of Creative industries within a country is based on local conditions, and it is not possible to fit the existing methodologies on the country because of its local specifics. Simply said, one size does not fit all. It is, therefore, suitable for countries while implementing and developing the Creative industries to smart-specialize in their strengths based on their local specifics. This means that countries should specialise in the export of creative products that have the potential to be successful on the international scale and at the same time avoid trying to compete with products that do not have this potential. Finally, middle-income countries should concentrate on promoting and developing the creativity of their population, which will sooner or later positively manifest itself on the state of the country.

The aim of the article was not to provide definitive guidance on the problem of stagnant middle-income countries, nor to provide advice on the successful implementation of Creative industries in these countries. The aim was to point out the potential benefits of innovation, employment growth, economic growth and other positive spill-over effects that Creative industries can bring to them. Countries can achieve these effects by implementing premeditated and thoughtful policies that support Creative industries; and thus deliver the most critical thing there is, raising the overall standard of living of its citizens.

### **Acknowledgment**

The article is the output of the project „Multi-factorial measurement of business performance and management in selected subsectors of creative industries.” (Vícefaktorové měření výkonnosti podniků a managementu ve vybraných odvětvích kreativních průmyslů), with the registration number FP-J-19-5859.



## References

- Banks, M., & O'Connor, J. (2009). After the creative industries. *International Journal of Cultural Policy*, 15(4), 365-373. doi: 10.1080/10286630902989027
- Castro-Higueras, A., & De Aguilera-Moyano, M. (2018). Assessing creativity: an index proposal. *Creative Industries Journal*, 11(1), 102-118. doi: 10.1080/17510694.2018.1434371
- Collins, P., Mahon, M., & Murtagh, A. (2018). Creative industries and the creative economy of the West of Ireland: evidence of sustainable change? *Creative Industries Journal*, 11(1), 70-86. doi: 10.1080/17510694.2018.1434359
- Cunningham, S. (2009). Creative industries as a globally contestable policy field. *Chinese Journal of Communication*, 2(1), 13-24. doi: 10.1080/17544750802638814
- Doner, R. F., & Schneider, R. (2016). The middle-income trap: more politics than economics. *World Politics*, 68(4), 608-644. doi: 10.1017/S0043887116000095
- Drab-Kurowska, A. (2017). State intervention in the context of creative industries. *Management*, 22(1), 74-84. doi: 10.2478/manment-2018-0006
- Felipe, J., Kumar, U., & Galope, R. (2017). Middle-income transitions: trap or myth? *Journal of the Asia Pacific Economy*, 22(3), 429-453. doi: 10.1080/13547860.2016.1270253
- Flew, T., & Cunningham, S. (2010). Creative Industries after the First Decade of Debate. *The Information Society*, 26(2), 113-123. doi: 10.1080/01972240903562753
- Gouvea, R., & Vora, G. (2018). Creative industries and economic growth: stability of creative products exports earnings. *Creative Industries Journal*, 11(1), 22-53. doi: 10.1080/17510694.2017.1416529
- Hennekam, S., & Bennett, D. (2017). Creative industries work across multiple contexts: common themes and challenges. *Personnel Review*, 46(1), 68-85. doi: 10.1108/PR-08-2015-0220
- Ito, T. (2017). Growth Convergence and the Middle-Income. *Asian Development Review*, 34(1), 1-27. doi: 10.1162/ADEV\_a\_00079
- Jones, C., Svejenova, S., Pedersen, J. S., & Townley, B. (2016). Misfits, Mavericks and Mainstreams: Drivers of Innovation in the Creative Industries. *Organization Studies*, 37(6), 751-768. doi: 10.1177/0170840616647671
- Jürisson V. (2007). *The Creative Economy and Offside in Cultural Policy: An Economies in Transition Perspective*. Paper presented at the VII Annual Conference of Estonian Social Sciences, Tartu, Estonia. Retrieved from <http://www2.sotsioloogia.ee/esso4/20402.pdf>
- Kloudová, J., & Chwaszcz, O. (2014). The analysis of the creative industry linked in connection with the economic development. *E+M Ekonomie a Management*, 17(1), 32-42. doi: 10.15240/tul/001/2014-1-003
- Kong, L. (2014). From cultural industries to creative industries and back? Towards clarifying theory and rethinking policy. *Inter-Asia Cultural Studies*, 15(4), 593-607. doi: 10.1080/14649373.2014.977555
- Lampel, J., & Germain, O. (2016). Creative industries as hubs of new organizational and business practices. *Journal of Business Research*, 69(7), 2327-2333. doi: 10.1016/j.jbusres.2015.10.001

- Lazzeretti, L., Boix, R., & Capone, F. (2008). Do Creative Industries Cluster? Mapping Creative Local Production Systems in Italy and Spain. *Industry and Innovation*, 15(5), 549-567. doi: 10.1080/13662710802374161
- Martinaitytė, E., & Kregždaitė, R. (2015). The factors of creative industries development in nowadays stage. *Economics & Sociology*, 8(1), 56-71. doi: 10.14254/2071-789x.2015/8-1/5
- Porfirio, J. A., Carrilho, T., & Mónico, L. S. (2016). Entrepreneurship in different contexts in cultural and creative industries. *Journal of Business Research*, 69(11), 5117-5123. doi: 10.1016/j.jbusres.2016.04.090
- Protođerou, A., Kontolaimou, A., & Caloghirou, Y. (2017). Innovation in the European creative industries: a firm-level empirical approach. *Industry and Innovation*, 24(6), 587-612. doi: 10.1080/13662716.2016.1263551
- Purnomo, B. R., & Kristiansen, S. (2018). Economic reasoning and creative industries progress. *Creative Industries Journal*, 11(1), 3-21. doi: 10.1080/17510694.2017.1403206
- Silvio, T. (2018). After creativity: labour, policy, and ideology in East Asian creative industries. *Culture, Theory and Critique*, 59(2), 75-80. doi: 10.1080/14735784.2018.1446839
- Skavronska, I. (2017). Creative Industries in Ukraine: Analysis and Prospects of the Development. *Economics & Sociology*, 10(2), 87-106. doi: 10.14254/2071-789X.2017/10-2/7
- Yao, Z. (2015). How Can China Avoid the Middle Income Trap? *China & World Economy*, 23(5), 26-42. doi: 10.1111/cwe.12126
- Zelazny, R., & Pietrucha, J. (2017). Measuring innovation and institution: the creative economy index. *Equilibrium*, 12(1), 43-62. doi: 10.24136/eq.v12i1.3

### Contact information

#### Mgr. Ing. Peter Mičák

Brno University of Technology, Faculty of Business and Management  
 Kolejní 2906/4, 61200, Brno, Czech Republic  
 E-mail: xpmicak00@vutbr.cz  
 ORCID: 0000-0002-5679-7675

doi: 10.7441/dokbat.2019.070

# SUSTAINABLE URBAN MOBILITY PLANNING IN THE MUNICIPALITY OF TARNÓW

*Maciej Michnej, Anna Kuczaj*

## **Abstract**

The aim of the article is to present selected aspects of the methodology of the Sustainable Urban Mobility Plan (SUMP) on the example of the city of Tarnów. The authors explained the fundamental differences between the traditional approach to urban transport planning and the sustainable urban mobility planning methodology, which allows a relatively quick understanding of the basic features of planning sustainable urban mobility in relation to the so-called traditional methods. The article presents the results of research on transport preferences of the Tarnów citizens and suburban areas. The research problem was to create a concept of sustainable development of the transport system in Tarnów, covering all sectors and forms of passenger transport in the city. Sustainable Urban Mobility Planning allows cities to meet several of the 17 United Nations sustainable development goals (SDGs) to transform our world: Affordable and Clean Energy, Good Health and Well-being and Sustainable Cities and Communities.

*Keywords: urban mobility, transport planning, sustainable transport, SUMP, quality of life*

## **1 INTRODUCTION**

It is estimated that in Europe by 2050 the number of city dwellers will increase to around 6 billion, while today around 80% of Europeans already live in urban areas. The popular among architects slogan "cities for people", is taking on a broader meaning in the context of the constant increase in the number of city dwellers (Michnej & Zwoliński, 2016). Therefore, it is necessary to take a closer look at the relations between urban mobility and the quality of life of residents, determined inter alia by clean air, noise protection, safety, or the freedom of people to move when, where and how they want - regardless of age, income or health (van Wee & Ettema, 2016). The progressing economic and spatial development of metropolitan areas in Poland and Europe, as well as the increasing expectations of passengers related to the comfort of movement, require constant efforts to improve the quality and increase the efficiency of transport systems. Activities aimed at improving or maintaining related to travel comfort of residents require creating system solutions that reduce the harmful effects of transport on the natural environment, improve mobility conditions and increase passenger safety. Currently, having a Sustainable Urban Mobility Plan (SUMP) in Polish cities is optional. Despite this, some centres are undertaking activities to develop their own documents (e.g. Gdynia, Krakow, Inowrocław, Poznan, Jaworzno), moving towards a new approach to mobility planning. Smaller centres show interest in the topic of strategic approach, as well as the integration of transport planning with the areas of spatial planning, environmental protection or health. However, the barrier is the fear of lack of financial potential for the development and implementation of SUMP, insufficient human resources to implement the entire process, as well as the lack of support at national level (legal framework).

Due to the problem of significant exceeding of harmful dust in the air, the awareness of the negative impact of individual transport on the environment is systematically increasing. It is also important that this transport has a low demand for space, which is why the authorities of many cities are gradually limiting the development of road infrastructure. However, it is

necessary to understand the idea of sustainable transport, which assumes that the development of public transport and encouraging the use of environmentally friendly modes of transport guarantees a better quality of life with the continuous development of cities.

## 2 THE SUSTAINABLE URBAN MOBILITY PLANNING CONCEPT

The idea of sustainable mobility is to change the transportation behaviours of urban residents in order to reduce the participation of a private car in everyday travels. (Nosal, 2011). This change will allow rapid development of all public transport, among others by expanding the network of tram and bus connections, renewing the public transport vehicle park, expanding the bicycle route network, and increasing the importance of pedestrian traffic. Currently, city dwellers are increasingly choosing public transport, bicycles as well as walking trips. European cities are striving for transport to be efficient, resource-efficient, ecological and low-carbon one (Hebel & Wyszomirski, 2019).

Tab. 1 – Traditional approach to transport planning and the SUMP technology. Source: Wefering et al. (2014)

<b>Traditional approach to transport planning</b>	<b>SUMP</b>
Focus on movement	Focus on people
Aim: smoothness and speed of movement	Aim: accessibility and quality of life
Focus on means of transport	Integrated with spatial planning, economic development, social needs, environmental quality and health
Short and medium term	Long term vision
Administrative boundaries of the city	Functional boundaries, including commuting areas
Political mandate and planning by experts	Important stakeholders and the public actively involved
Domain of traffic engineers	Interdisciplinary planning
Focus on infrastructure	A combination of infrastructure, market, service and information and promotional solutions
Limited impact assessment	Intensive assessment and shaping of learning and improvement processes

As defined in the official guidelines of the European Commission (Wefering et al., 2014), the Sustainable Urban Mobility Plan is a strategic plan designed to meet mobility needs of people and the economy in the city and its surroundings, at the same time ensuring a better quality of life. It is based on existing planning practices and takes into account issues of integration, public participation and evaluation principles (Hrelja et al., 2017). It should be emphasized that the Sustainable Urban Mobility Plan is not just another planning document, but it is an ongoing process that is subject to monitoring, evaluation and updating of adopted goals and activities (Lee & Sener, 2016). The differences between the traditional approach to transport planning and the SUMP "methodology" are shown in Table 1.

## 3 TARNÓW MUNICIPALITY

The Tarnów Municipality is the most important population centre in the Małopolska (Lesser Poland) province after Krakow. It is located in the south-eastern part of the province at the intersection of important trade routes. It covers an area of 72.38 km<sup>2</sup>. Tarnów is a city with municipal rights. It is headed by the President and the City Council. The city is divided into 16 districts, which are shown in Figure 1. Urban buildings are primarily characterized by multi-family housing. The main clusters of apartment blocks are located in the Jasna, Westerplatte and Legionów Dąbrowskiego housing estates. The historical centre of the city is particularly compact. Due to its administrative functions, there are a number of local government institutions from the commune level to the units being province branches.



Fig. 1 – Division of Tarnów into districts. Source: Public Information Bulletin of the Tarnów

The statistical guide of the city of Tarnów issued in 2018 presents detailed information on demographic and economic data for the previous year. In December 2017, the population of Tarnów was 109.7 thousand inhabitants. From year to year, this number is decreasing, which is caused by the negative population growth and migration of the population outside the city. Thus, the population density is decreasing; currently it is 1515 people/km<sup>2</sup>. Aging is also becoming increasingly noticeable. The number of children and adolescents is decreasing, while the number of people in post-working age is increasing. There were 40,000 people employed in Tarnów in 2017. The statistics did not take into account the place of residence, but people actually working in the Tarnów Municipal Commune. Most of the operating companies belong to the group of small and medium-sized enterprises. Much larger companies that employ up to 1,000 people also have their headquarters in Tarnów.

#### **4 STUDY OF TRANSPORT PREFERENCES OF PEOPLE MOVING AROUND THE TARNÓW MUNICIPAL COMMUNE**

In order to determine the vision regarding the development of Tarnów's transport system, a survey of residents' transport preferences was conducted in the form of a questionnaire on a sample of 110 respondents. The survey was conducted electronically, using Google Forms, facilitating its creation and quick analysis. It was made available in November 2018 on the social networking site [www.facebook.pl](http://www.facebook.pl) among groups of users from Tarnów or its surroundings. The survey was mainly attended by young people under the age of 60.

Sixty percent of respondents gave a car as the main way of daily travel. The advantage of this means of transport is significant, because the second most often chosen (public transport) reached only 20% while the private bus carrier 6.4%. Pedestrian traffic is declared by 8.2% of respondents, which is due to the small area of the city and the fact that the purpose of movement is within a short distance. The lowest number of votes was obtained by bicycle transport - 3.6% and railway - 1.6% that the purpose of the journey is only a short distance away. The most important thing for travellers when choosing a means of transport (Fig. 3) is travel comfort, travel time and availability. As part of open responses, the respondents also declared reliability (including punctuality) and the lack of availability of alternative modes of movement.

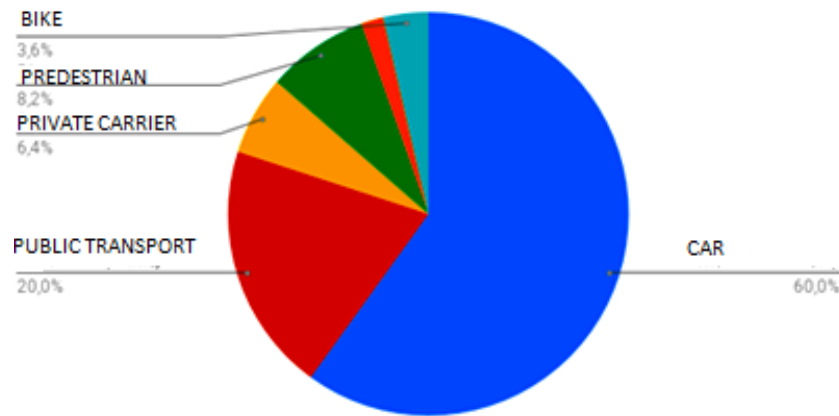

Fig. 2 – The main means of transport. Source: own research

The next question asked to choose three reasons, which, in the opinion of the respondents, adversely affect the functioning of transport in the Tarnów Municipal Commune. An open variant has also been added so that respondents can add their own insights. The largest number of votes received an answer on the creation of congestion (so-called traffic jams), insufficient number of parking spaces and poor quality of infrastructure.

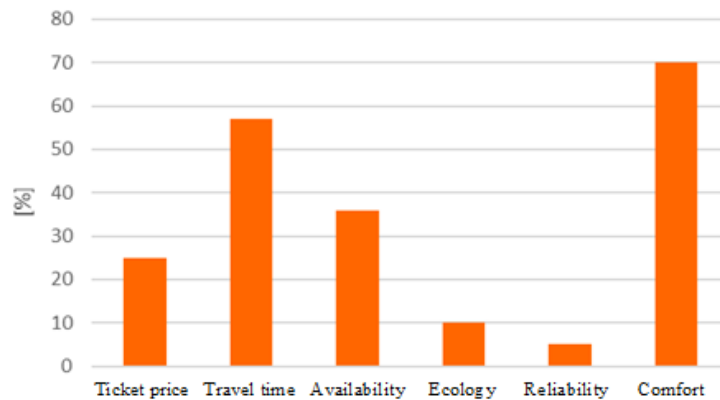

Fig. 3 – Decision factors when choosing a means of transport. Source: own research

The respondents also pointed out that a frequent problem hindering movement around the city are renovations, especially those that are prolonged and cover several locations at once. Attention was also paid to the fact that city buses run too rarely, especially during city rush hours. The list of respondents' answers is presented in Figure 4.

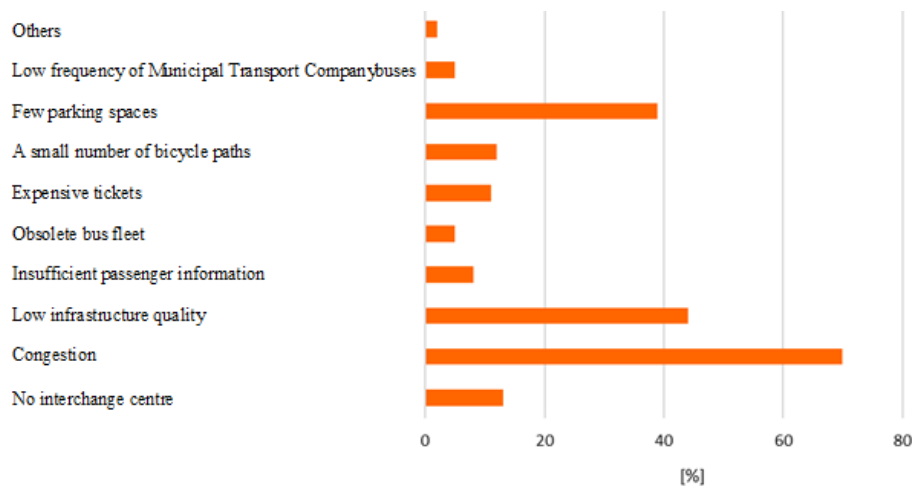

Fig. 4 – Problems of getting around in Tarnów. Source: own research

The respondents were also asked to provide three positive features of transport in Tarnów. They pointed to the city bike rental system first, followed by the renewal of the public transport bus fleet as well as the Park & Ride car park operating near the railway station. Among their own suggestions, there were answers regarding the limitation of car traffic in the historic city centre.

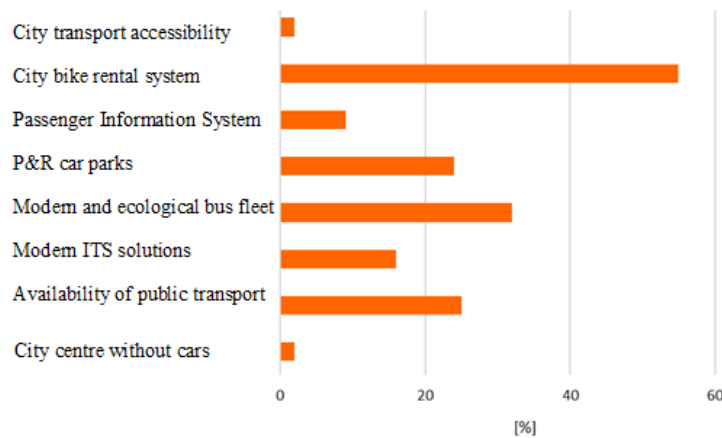

Fig. 5 – Positive aspects of the Tarnów transport system. Source: own research

Finally, there was an additional question in which the respondents could give their own suggestions, visions of changes in the functioning of transport in Tarnów. Thirty-one people took advantage of this opportunity (28% of respondents). One of the most popular topics was cycling in the city. The respondents suggested to develop a network of bicycle paths, modernize them and expand the number of city bike rental stations. Public transport was another common topic. The respondents pointed out the insufficient frequency of buses, especially during rush hour, in their opinion part of the line should be extended and the bus rolling stock should still be renewed. Attention was also paid to the availability of tickets (a small number of ticket vending machines).

## 5 DETERMINING THE VISION AND PRIORITIES FOR THE DEVELOPMENT OF THE CITY OF TARNÓW IN RELATION TO URBAN MOBILITY

The vision allows answering key questions about the concept of the city in which the inhabitants want to live. As one of the basic pillars of the Sustainable Urban Mobility Plan, it is the starting point for the definition of technical objectives and activities. Since the vision is a guide for the development of planning activities, it should contain a description of the desired future of the city, placing transport and mobility in the broad context of city and society development. According to the guidelines of the vision, it should be prepared taking into account all political frameworks, especially spatial planning, economic development, shaping the environment, social integration, gender equality, health and safety. Based on the survey and assessment of the strengths and weaknesses of the planning process used, the following are suggestions for the desired features of sustainable urban mobility. Tarnów - a city for the development of effective and environmentally friendly ways of travelling, meeting the needs of residents and being an attractive alternative to travelling by one's own car. The proposed vision for the development of the city of Tarnów indicates the main areas of activity in mobility planning, i.e. functionality of the transport system, protection of the natural environment, spatial planning, safety and economic efficiency. Strategic priorities that are also directions of intervention in the implementation of the vision are presented in Table 2. A derivative of the vision constituting a qualitative description of the city's future are its priorities determining the characteristics of

the expected changes. The measurability of these changes can only be ensured by means of carefully selected sets of objectives focusing on selected areas of urban mobility.

Tab. 2 – Strategic priorities for SUMP. Source: own research

Level	Priority
1	Reducing environmental pollution caused by transport
2	Efficiency of passenger and cargo transport in the city
3	The quality of public spaces
4	Comfort and safety of transport
5	Availability of sustainable transport to workplaces and services

## 6 SELECTED ACTIVITIES FOR THE IMPLEMENTATION OF TARNÓW'S VISION OF DEVELOPMENT IN RELATION TO SUMP

### 6.1 Expansion of the city bike system

Tarnów City Bike, based on the results of the survey and data provided by Nextbike published on their website, indicates that the project was a great success. Therefore, it is worth expanding the offer to include more stations and bikes available to residents. Currently operating stations are located near places that are centres of the city's cultural life, such as parks, squares, and art centres. Therefore, it is worth organizing stations near housing estates and interchanges, which will encourage residents to use bicycles also as a way to travel to school or work. Figure 6 shows the proposed locations for new bicycle stations.

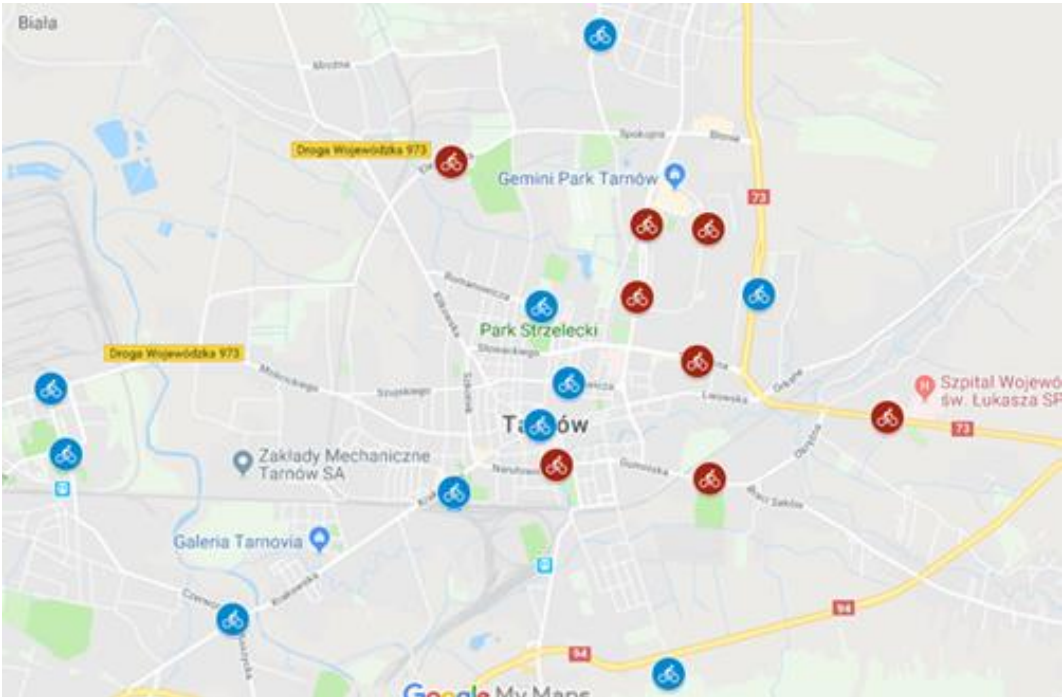

Fig. 6 – Tarnów City Bike stations. Source: own research

The stations operating from September 2018 are marked in blue; the proposed eight new locations are marked in red. The selected places are: St. Luke Provincial Hospital, Sangruszków Park in the Gumniska district, Narutowicza Street, The housing estate of XXV-lecia PRL, Tarnów Sports and Recreation Center, Westerplatte estate, Nowodąbrowska Street at the Legionów housing estate and Elektryczna Street near Piaskówka Park. In these places large groups of people live. The Westerplatte and Legionów housing estates are the most inhabited settlements in Tarnów. In addition, Narutowicza Street is the seat of commercial and service



outlets and the District Office and District Court. As the popularity of Tarnów City Bike increases, in the next step the authorities should concentrate on the bicycle network by placing stations near smaller settlements (Bąk, Hoy, & Solecka, 2019).

## 6.2 Park & Ride car parks

Park & Ride parking lots should, by their location, encourage travellers to leave their cars in the parking lot and use public transport. Figure 7 presents the proposed two new locations. Two places have been marked in red. P + R parking at the Tarnów - Mościce train station, which should be considered due to the convenience of rail travel to the city centre (about 3 minutes), but also the short distance of public transport bus stops. Next to the station there is the Czerwonych Klonów (Red Maples) stop, while a few dozen meters away the Mościce bus terminus on which, among others, lines 1 and 9 are serviced, characterized by high frequency of travel and large passenger streams.



Fig. 7 – Proposed location of additional P + R parking lots. Source: own research

Another proposed location is the area near the intersection of Jana Pawła II Avenue with Błonie Street, near the exit to the city centre from the A4 motorway. This car park would be located directly on the access road to Tarnów from Dąbrowa Tarnowska, Żabno and Szczucin, i.e. three closely located cities, as well as in the vicinity of the Gemini Park shopping gallery and one of the most inhabited housing estates (Jasna, Westerplatte). Therefore, this area is well linked by public buses with the city centre.

## 6.3 Paid parking zone extension

Due to the lack of sufficient parking spaces in relation to the demand and the traffic in the city centre, it is worth considering the possibility of extending the paid parking zone by additional areas. The extension of the parking fee zone will increase the rotation of parking vehicles and discourage some drivers from entering the fee zones and leaving vehicles for a long period of time (Michnej & Zwoliński, 2018). It is proposed to extend the zone by another 1 km<sup>2</sup> closely adjacent to the existing area, as shown in Figure 8.



Fig. 8 – Proposed paid parking zone in Tarnów. Source: own research

## 6.4 Passenger Information

In order to improve the readability of public transport timetables, the presentation of information should be standardized. Particularly differences in the pattern of creating a timetable printout can be seen on lines with higher frequency of courses during the day than the others. Their layout and font are different from the others, thus impairing readability. It may be a good idea to break the timetable into separate charts for weekdays, Saturdays and public holidays. Thanks to this, the problem with a large format ceases to appear, while the possibility of using legible digits is no longer present. Another important aspect for getting around the city by public transport, especially for city visitors, is to provide summary information about the ticket fares and places to buy tickets as well as to add a city line diagram, together with an indication of the places where transfers can be made to other lines. This information is available only on the website of the Road and Communication Board in Tarnów and inside vehicles. Adding them to bus shelters will facilitate the use of MPK services also for visitors.

## 7 CONCLUSIONS

The Tarnów Municipality is a city with great development opportunities. For several years, it has been struggling with problems regarding the emigration of the population and the aging society. The participation of cars in private travel is also becoming more visible. This phenomenon has a negative effect on the time and manner of getting around the city, the quality of life of residents, and has a negative impact on the natural environment. Therefore, it is crucial for city authorities to look for solutions that can neutralize or reduce the negative impact of transport on the quality of life of residents. In addition to environmental benefits, an efficiently operating transport system, free of congestion, time spent in traffic jams, and comfortable and safe for travellers will significantly enhance the image of the city not only in the eyes of residents, but also visitors.

The idea of sustainable development of transport is primarily based on changing the habits of users by encouraging them to use public transport, bicycles or pedestrian traffic at the same time using passenger cars. Urban marketing that promotes this style of activity is also important. This is not possible, however, without properly prepared infrastructure and organization. One of the most important elements that was successfully implemented by the Municipality of Tarnów is starting the Tarnów City Bike, which has become very popular despite a very short season in 2018, as it lasted only two months. Therefore, it is worth considering the possibility of developing this mode of transport with more rental stations, and with new bike paths or stands for private bicycles. The announcement of changes in the functioning of public transport

was published as part of the plan currently subject to public consultations. Attention has been paid to the need of maximizing connections during the highest traffic intensity. However, there are still many issues worth considering. The selected solutions proposed in the article place particular emphasis on using alternative forms for road transport. The benefits of their use will not solve current problems, however, in the long term, they will help to reduce them.

## References

- Bąk, A., Hoy, K. N., & Solecka, K. (2019). Multiple Criteria Evaluation of the Planned Bikesharing System in Jaworzno. In G. Sierpiński (Ed.), *Smart and Green Solutions for Transport Systems*. Cham: Springer. doi: 10.1007/978-3-030-35543-2\_8
- Hebel, K., & Wyszomirski, O. (2019). Commuting to Places of Work and Study in the Light of Marketing Research Results with Particular Emphasis on Gdynia in Poland. In M. Suchanek (Ed.), *Challenges of Urban Mobility, Transport Companies and Systems*. Cham: Springer. doi: 10.1007/978-3-030-17743-0\_5
- Hrelja, R., Monios, J., Rye, T., Isaksson, K., & Scholten, C. (2017). The interplay of formal and informal institutions between local and regional authorities when creating well-functioning public transport systems. *International Journal of Sustainable Transportation*, 11(8), 611-622. doi: 10.1080/15568318.2017.1292374
- Lee, R. J., & Sener, I. N. (2016). Transportation planning and quality of life: Where do they intersect? *Transport Policy*, 48, 146-155. doi: 10.1016/j.tranpol.2016.03.004
- Michnej, M., & Zwoliński, T. (2018). Parking Management as Proven Strategy for Urban Mobility. In M. Suchanek (Ed.), *New Research Trends in Transport Sustainability and Innovation*. Cham: Springer. doi: 10.1007/978-3-319-74461-2\_18
- Michnej, M., & Zwoliński, T. (2016). Objectives and Strategies of Sustainable Urban Mobility Planning in the City of Krakow. In M. Bąk (Ed.), *Transport Development Challenges in the Twenty-First Century*. Cham: Springer. doi: 10.1007/978-3-319-26848-4\_8
- Nosal, K. (2011). Mobility Management Concept and Examples of Its Usage in Polish Conditions. *Transport Problems*, 6(4), 13-22. Retrieved from <http://yadda.icm.edu.pl/baztech/element/bwmeta1.element.baztech-article-BSL9-0065-0036>
- van Wee, B., & Ettema, D. (2016). Travel behaviour and health: A conceptual model and research agenda. *Journal of Transport and Health*, 3(3), 240-248. doi: 10.1016/j.jth.2016.07.003
- Wefering, F., Rupprecht, S., Buhrmann, S., & Bohler-Baedecker, S. (2014). *Guidelines. Developing and Implementing a Sustainable Urban Mobility Plan*. Retrieved from [http://www.trt.it/documenti/guidelines-developing-and-implementing-a-sump\\_final\\_web\\_jan2014b.pdf](http://www.trt.it/documenti/guidelines-developing-and-implementing-a-sump_final_web_jan2014b.pdf)

## **Contact information**

### **Maciej Michnej**

Cracow University of Technology, Faculty of Mechanical Engineering

Al. Jana Pawła II 37, 31-864 Cracow, Poland

E-mail: maciej.michnej@mech.pk.edu.pl

ORCID: 0000-0003-0030-1973

### **Anna Kuczaj**

Cracow University of Technology, Faculty of Mechanical Engineering

Al. Jana Pawła II 37, 31-864 Cracow, Poland

E-mail: kuczaj@gmail.com

ORCID: 0000-0002-9994-7653

doi: 10.7441/dokbat.2019.071

# E-BUSINESS TECHNOLOGY

*Denisa Mikulová*

## **Abstract**

In today's dynamic environment, where factors are changing rapidly and competition in the market is increasingly important, quality and information is much wilder and more unpredictable. Moreover, today's environment is overwhelmed by information, and it is becoming increasingly difficult to reach those who can improve their performance. Competitive analysis of e-shops in the food industry was carried out. There are many food websites in the online world, but only a small percentage of them can succeed. The paper focuses on the topic of e-commerce with a focus on building a quality e-shop. This article also aims to link e-commerce to e-commerce quality. The main focus of the thesis is research, research of literary and scientific sources. Competitive analysis was carried out in the e-shop with groceries. This information will be further used in my doctoral thesis, which deals with building a quality e-shop in the food industry. Using the research results, it will be possible to make recommendations to other Internet businesses, but the specific methodological model of website tool implementation will be suitable for e-shops. In companies, the importance of e-commerce in web quality is underestimated. This can lead to a drop in sales or a loss of competitiveness.

*Keywords: internet, e-shop, websites, customer, e-commerce, e-business*

## **1 INTRODUCTION**

Companies invest millions of euros in information technology to build process capacities and increase their competitiveness. However, not all investments in E-business generate the expected results. This situation requires managers to carefully assess all their investments in E-business. It remains unclear whether and how investment in e-business affects a wider set of operational capabilities and performance over time. Given that E-business and operational capabilities, together with their relationship and impact on business performance, can be dynamic, there seems to be a significant gap.

E-business technology can improve the business management system by enabling real-time information exchange across the supply chain. However, e-business techniques are becoming commodity and can be affordable for most large businesses, which can reduce their potential to generate operational benefits over time. This leads to our first question: How does investment in e-business technology affect your company's business management system over time? The company's operational capabilities can be improved with time and experience. Earlier developers of operational capabilities through early investments in e-business technologies can achieve greater competitiveness due to longer duration and experience in developing their operational capabilities. This leads to our second question: Initial and subsequent investments in e-business technologies result in differences in the impact of traffic management on the competitiveness of a business over time? The main aspect is to examine the evolution of the impact of e-business technologies on operational competencies and solid profitability over time. Early development of IT-enabled operational capabilities increases business profitability as the company has more time and experience in developing its operational capabilities.

For example, some companies use social media web tools such as LinkedIn, Facebook, and Twitter to get a functional managerial talent that matches the profile needed to design a talent

foundation. Web technology enables the company to realize planning and flexibility in the workplace to maintain operational talents and provide reliable information on goal completion, performance evaluation and career planning to develop and maintain operational talent. Finally, using Web-based business applications allows you to better perform operational routines and deliver products to markets for operational excellence.

We also predict that the positive impact of e-business technologies on operational competencies may decrease over time for two reasons. First, further investments in e-business technologies (after investments in previous periods) may reduce operating marginal revenues. Second, e-business technology was a commodity and can be affordable for most businesses. Subsequently, downstream companies can learn to invest in e-business technologies and develop e-business capabilities that can convert e-business technology into a non-unique / imitable ability, and its impact on operational competencies may diminish over time.

Bednářová and Parmová (2010) said trade as an independent economic activity originated already on the border of family and slavery society after the crafts were separated from agriculture. A simple commodity exchange was transformed into a money exchange, where the aim of the exchange was to obtain another product. The need for a mediator of economic transactions led to the emergence of trade, traders." The exchange of products, goods, gradually switched to exchange for money. As Jiří Jindra states, Retail Management trade is a link between production and the consumer. Similarly, wholesale is a link between production and retail, respectively. trade can be understood in two ways - in a broader sense as an activity and in a narrower sense as an institution." (Bednářová & Parmová, 2010)

### **1.1 Importance, history and function of trade**

Sedláček said „trade as an activity involves the purchase and sale of goods, but business activities may also be engaged by manufacturing entities. In addition, trade includes activities in which services, information, energy or securities are traded. Trade as an institution is made up of entities that deal mostly with trade, but also those purchasing physical goods for resale without undergoing a major adjustment." Trade in physical goods can be further divided into two parts, namely consumer goods (final consumer goods) and goods for other business (run by commercial companies and manufacturing companies). Turban presents „the main functions of trade, i.e. requirements of business partners to the level of business activities, are the conversion of the product range to the business range, overcoming the differences between the place of production and the point of sale, overcoming the difference between the time of production and purchase of goods."

### **1.2 E-Commerce**

An electronic transaction is the sale or purchase of goods or services via computer networks designed to receive or issue orders. Goods or services are ordered through these networks, but payment and delivery need not be made online. The transaction may take place between entrepreneurs, households, individuals, the government and other public or private organizations.

Paris (2016) presents „the second version of the OECD definition. This differs only in the substitution of an electronic transaction for an internet transaction and the purchase or sale of goods and services is done via the Internet."

According to author Kim (2018), „the history of Internet business begins around thirty years ago. Back then, it was more of a way to facilitate business transactions through electronic channels. One of the first ways of doing business in the Internet field was the commercial introduction of intranet in the 1980s, i.e. hardware and software technologies associated with

TCP / IP protocol into the company's internal information systems.” Thus, it was a way of making money “around the Internet”, but so far only as a result of the installation of these technologies, not as a result of their operation. Extranet applications, networks interconnecting individual intranets, could build on intranet systems. In practice, these were mainly EDI (Electronic Data Interchange) systems, i.e. a system for the automated exchange of structured documents such as invoices, and EFT (Electronic Funds Transfer), a similar system for the exchange of information on financial transactions. In the 1980s, however, these systems only succeeded in larger companies with a large volume of business transactions, due to the high cost of deployment of these technologies.

Oliveria (2017) said, in 1991, the National Science Foundation lifted its ban on the commercial use of the Internet. This, together with the cheaper computing in the 1990s, "opened the floodgates" to a huge wave of interest in the Internet and making it accessible to ordinary users and smaller businesses.” This has brought with it the rapidly advancing commercialization of the Internet. Initially, companies used the Internet as a mere whiteboard for presenting their own products. However, as the network grows, more sophisticated, not only graphically attractive, sites are emerging, with security systems for accepting online purchases and integrated databases collecting customer information - the first e-commerce is being created. In connection with human typically continuous thinking and the innate tendency to use new technologies initially in a way corresponding to the use of existing technologies, e-shops can be considered as the first phase of e-business.



Fig. 1 – E-commerce platform. Source: Communixlab Digital Marketing Academy (n.d.)

### 1.3 E-business vs. E-commerce

These two terms are used as synonyms in everyday life, but there is a difference in meaning between them. Cheung (2016) describes „in the Czech environment, the term electronic commerce is perceived either in terms of all business activities, which include both operational and technical-logistic activities (e-business), or in the narrower sense, whose content is the exchange of goods and services for equivalent value between individual sellers and buyers, respectively. (e-commerce).” Following this concept, according to Piyush (2016), e-commerce can be described as a subset of e-business. Thus, e-commerce primarily includes activities related to the purchase and sale of goods, customer service and distribution of goods, while e-business is a much broader concept that encompasses many other business-related activities



using modern digital technologies. For example, EUROSTAT defines e-commerce in its methodological documents as various transactions carried out via a computer-mediated network that involve the transfer of ownership or rights of use of goods or services.

According to Fleisch (2015), „e-business, as an e-business in its broadest sense, is something with hard-to-determine boundaries. With today's very dynamic development in this area, new applications and opportunities for their successful business are constantly emerging. In general, e-business can be described as a way to facilitate communication with partners, how to achieve savings by using an effective common (electronic) language, how to communicate with anyone and from anywhere, significantly reducing transaction costs.” Petit (2019) said „businesses can also benefit from engaging in e-business by streamlining administrative operations, managing their business more efficiently, and communicating with partners, authorities, and the public, all of which can mean cost savings or cost savings. competitive advantage over competitors.” Chao (2016), in a broader definition, „refers to an electronic transaction as the purchase or sale of products and services between entities through computer networks, delivery can be done online or offline. This concept also includes forms of e-commerce that have nothing to do with the Internet – e.g. teleshopping.” A narrower definition refers to an internet transaction and, in contrast to a broader definition, confines it to the medium of the Internet. Thus, e-business (in a broader sense) is not the same as Internet trade, although it is the most significant and increasingly important part.

The OECD, like many other authors of Wang (2018), „distinguishes types of e-commerce by supplier and customer entities (and their denominations from English names). The most common distinction is between two basic entities on each side, entrepreneurs (B - business) and consumers (C - consumer), sometimes joined by the government (G - government).” The main types of e-commerce are: **B2C (business to consumer)** - sales of goods and services from entrepreneurs to end consumers. It is associated with the concept of e-shop and is a kind of alternative to the classic "stone shops". It is the most conspicuous form of e-commerce for the average Internet user. **B2B (business to business)** - sale of goods and services between business entities, not intended for final consumption. As far as the volume of transactions is concerned, it is certainly the largest type of e-commerce. For example, in 2005, 93% of turnover generated through computer networks in the EU-25 was from B2B transactions. **C2C (consumer to consumer)** - sales of goods and services between consumers. These include mainly electronic auctions (e.g. e-bay.com, aukce.cz, etc.), various consumer advertisements and some other forms of trade.

This chart displays the share of enterprises that realized B2C e-commerce sales through a website in the Czech Republic from 2013 to 2018. In 2018, 16 percent of enterprises in the Czech Republic made B2C e-commerce sales by a website.

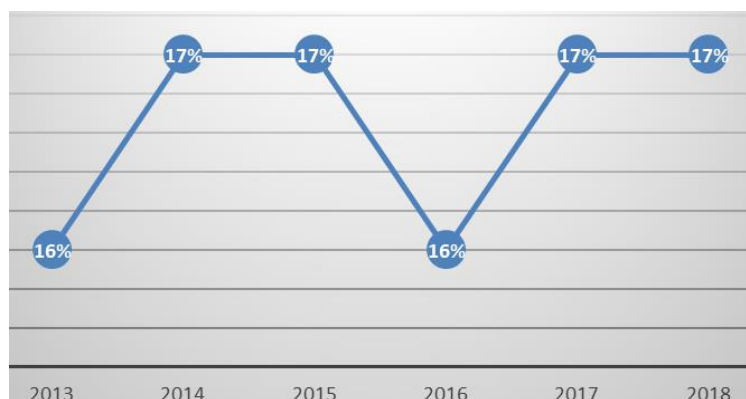

Fig. 2 – Share of enterprises that make B2C e-commerce sales by a website. Source: own research



C2B (Consumer to Business) - this is again a of goods and services to final consumers, but the initiative is based on the consumer, where specific demand is located somewhere on the Internet. The manufacturer (if able and willing) will satisfy it, either by itself, or it is forwarded to him by an intermediary server that acts as an aggregator of these requests.

Piyush (2016) said ..in another form of C2B, Zhou advocates providing the computing power of a consumer's computer to a businessman for remuneration. C2G and G2C (Consumer to Government and vice versa) - includes mainly the purchase of certain goods or services by a citizen from the state, respectively. payments by a citizen of the state, e.g. various taxes.” For the purposes of this work, I will consider e-commerce within the meaning of the OECD's narrower definition, i.e. e-commerce, and will focus specifically on B2C.

#### **1.4 Current state and trends in e-commerce**

According to some authors, including Kozinets,, „we are currently somewhere between the second and third stages of e-commerce development, i.e. maturation, respectively maturity. The second stage of e-commerce can be talked about since 2001, and the “dot-com crash”, or “internet bubble burst”, is identified as the border point.” The Internet Fever or the Internet Bubble is a sign of a period of massive boom for Internet companies that did not have a sophisticated business model and soon went bankrupt but managed to attract massive investments. This period lasted approximately from 1996 to 2001, with the peak of investment in 2000. In 2001, the so-called internet bubble burst and overvalued shares lost their value. Internet fever has hit most the United States and other Western countries. In the Czech Republic, it manifested itself in the establishment of portal servers such as Redbox.cz, Quick.cz and other smaller ones.”

Chen said „in general, today's situation in the field of e-commerce is seen as a kind of market stabilization and consolidation process, which is still experiencing significant growth and more is expected. However, the main players in the field of e-commerce, giants such as Google or Microsoft, who share a substantial part of the Internet among themselves.”

#### **1.5 The global trend of e-commerce**

Online retail again jumped in numbers, both worldwide and in our country. Humair presents „APEK informed in October that “Czech e-shops are doing well. Also, in 2018, they will probably achieve annual turnover growth of more than 15%. As a result, they will exceed 11% of the total retail business in the Czech Republic. “At least once a year, they buy 90% of Internet users online. 53% of us do this at least once a month. B2B purchase is growing. We are also increasingly ordering from mobile. The differences between retail and digital are blurred. These are the trends we feel as sellers and consumers.

## **2 WEBSITE**

### **2.1 Analysis of web activities**

By traffic we mean any activity that the user on website. Activity analysis means monitoring individual activities user steps, tracking of incoming links, commercial feedback campaigns. Data from web activity analysis is used for subsequent decision making and streamline the website, but also the whole marketing. In the case of web presentations already operating on the Internet, it is recommended work with data from at least one past year. The output of web analysis is knowledge of whether the site meets expectations and goals business. To measure the effectiveness of Internet marketing, there are several on the market tools that allow for detailed evaluation of deadlines and based on which can roughly determine your return on

investment for paid campaigns. In the world, the term “ROI - return on investment” is widely used

Capture users with web analytics tools several key aspects:

- a) How long the user spent on the site;
- b) Which sections attracted the visitor most;
- c) Where the user visited our site;
- d) Whether it is an existing or a new visitor;
- e) The number of pages visited per visit;
- f) On which pages the visitor leaves the site;
- g) Which keywords led the visitor to the site;
- h) Tracking the progress of an order in the case of an e-shop.

## **2.2 Website analysis**

Falk (2015) said „user testing is probably the most practical way of exploring a website, as it draws conclusions based on the behaviour of real web users led by a specialist in a pre-prepared scenario.”

User testing typically consists of the following steps:

- 1) Definition of the target group;
- 2) Preparation of testing scenario and selection of suitable methods;
- 3) Selection and Invitation of Testers (Persons Involved in Testing);
- 4) Performing user testing;
- 5) Evaluation of obtained materials;
- 6) Creating the final report.

According to the author Grossnickle „the actual process of testing consists in guiding the user according to a pre-created scenario and recording his activity. The recording usually takes the form of an audio and video recording, a text recording, and possibly 10 recording of all the events on the screen during testing.” As is clear from the very nature of user testing, this method is best suited for verifying specific solutions and generally the "soft" features of a website - those that cannot be strictly assessed as right / wrong. This group typically includes usability and specific user interfaces. However, user testing is also often used for practical verification of website accessibility or for assessing its business and marketing persuasiveness. Especially when it comes to website usability, user testing uses several tools - besides the most common practical scenario browsing, it is a test of the clarity of terms taken out of the context of the web, blind screen testing or visual memory test.

## **2.3 Statistic methods**

Escobar-Rodríguez (2017) said „the use of statistical methods is the most common for websites for traffic analysis. Usually, specialized software tools are used for this purpose, combining measurement, analytical and presentation functions. An example of such a tool is the free Google Analytics<sup>7</sup> or paid ClickTracks<sup>8</sup> software.” The following analytical procedures in the area of statistics are the most widespread:

**Time series analysis** - the time dimension plays a major role in visitor statistics. It is important when comparing periods, monitoring trends, averages over selected periods, and assessing seasonal fluctuations. That is why the methods of time series analysis are used very often - typically they are moving averages, seasonal data adjustment or prediction of further development.

**A / B testing** - consists in the preparation of two or more variants of the test object (in our case typically a specific website) and subsequent presentation of these variants to users, while monitoring and statistically evaluating the success of each of them. The prerequisite for successful A / B testing is that:

- 1) the test groups were the same size,
- 2) the test groups were homogeneous,
- 3) participants in each group were randomly selected,
- 4) The whole measurement was valid and reliable.

Falk (2015) said „A great advantage of A / B testing is quality results at relatively low cost. It is possible to use already prepared unpaid tools (e.g. Google Website Optimizer<sup>10</sup>), so the biggest cost remains to create an alternative version of the tested page. The fact that A / B testing can be performed in full operation is also an advantage.” On the other hand, a relatively significant limitation is that in order to achieve quality and relevant results, we need to change only one element at a time, because combinations of multiple changes cannot be demonstrably evaluated.

## **2.4 Correlation analysis**

According to Gregory (2017) „tracking interdependencies between indicators is similar to time series analysis as one of the main activities in traffic analysis. For example, we may be interested in the dependence of the site conversion rate<sup>11</sup> on the total number of visitors, the relationship between the conversion rate and each traffic source (direct access, referral visits, search engine access, etc.), or characteristics from which.”

## **2.5 Website analysis**

Web as a part of company marketing according to Grossnickle „the website (in the sense of the website) is one of the company's basic marketing tools today. It has inherently become a part of several components of the marketing mix<sup>13</sup> - at least in the field of promotion and distribution. For many companies, however, the product itself and its pricing policy are highly dependent on the Internet, and in such a case, the marketing mix is fully affected by the website.” When we talk about engaging the website in corporate marketing, we should focus more on its specific part - internet marketing. It is from the perspective of Internet marketing that websites can be viewed in two ways, each with its own proponents and opponents:

- 1) Websites as part of Internet marketing and one of the Internet promotions channels;
- 2) Website as a separate entity for the promotion of Internet marketing.

Whichever definition we choose, it is evident that without a website, almost no company can do marketing today.

## **2.6 Analysis of competition**

Jo (2019) said „although most companies know their competition, not all of them realize that with the spread of information technology, competition is no longer taking place "only in the

streets" and through price wars or product innovations, but also in the Internet, playing more than anywhere else. The role of a creative approach to sales and promotion, distinct from others and a distinctive style." It is here that firms that have little (or even no) background in the "stone world" and are often equal competitors to large corporations with many years of history are emerging.

In order to find out who is our competitor on the Internet and in what area we are competing with it, we should take the following steps as described by Hitpass (2019):

- 1) **Analysis of results in full-text search engines** - this consists of searching for queries that are relevant to our field of activity in the most used search engines. From the highest displayed results, you can then list links to specific competing websites.
- 2) **Analysis of results in commodity search engines** - if we sell some goods, it can be assumed that our competitors use commodity search engines (e.g. Zbozi.cz, Heureka.cz, etc.) to bring visitors to the website. Therefore, we should also look for competitors through appropriate queries.
- 3) **Finding Competitors in Internet Catalogues** - When browsing general (e.g. companies.cz) and specifically targeted (e.g. topobchody.cz focused on e-commerce) company catalogues, we often come across our most important competition.
- 4) **Analysis of page links** - as websites are traditionally linked by hyperlinks on the Internet, we should examine outbound links in the group of previously found sites (see the previous three points) that can bring us to other competing websites.
- 5) **Examining the content of found sites** - Once we have an initial list of possible competitors, we should thoroughly investigate the sites they contain to verify that they are really competitors. Previous analysis could have led us to commercial and non-commercial, sales and content sites, and it can be assumed that only a fraction of them actually compete with us in the same area.
- 6) **Finalize the list for further processing** - In the final step, we should sort the sites into a final list that is suitable for further use. Typically, at this stage, additional information is added to the site to help us further analyse - such as the name and contact details of the provider, factors affecting search engine placement (Google Toolbar Page Rank14, Srank15, backlinks, etc.), ideas, and other notes.

This could look like the output of competitive analysis for the website www.rohlik.cz. Specific data collected for each e-shop with food should be selected according to the purpose of the analysis and its expected further use.

Tab. 1 – Competitive analysis. Source: own research

Online food	URL	Availability	S-rank	GTPR	Number of back links
<b>Rohlík</b>	<a href="https://www.rohlik.cz/">https://www.rohlik.cz/</a>	Praha, střední Čechy, Brno, Pardubice, Hradec Králové, Plzeň, Liberec, Jablonec nad Nisou.	65	6/10	12 382
<b>Košík</b>	<a href="https://www.kosik.cz/">https://www.kosik.cz/</a>	Praha, střední Čechy, Pardubice, Chrudim, Hradec Králové, Plzeň, Liberec, Jablonec nad Nisou, Ústí n. Labem, Teplice.	82	4/10	157
<b>Tesco</b>	<a href="https://www.itesco.cz/">https://www.itesco.cz/</a>	Praha, střední Čechy a okolí, Brno, Blansko and surroundings, Břeclav, Hodonín and surroundings, Pardubice, Hradec Králové a okolí, Mladá Boleslav and surroundings	40	5/10	754

Workflow - the following search engine queries were used in the analysis:

- a) about buying food online;
- b) for home food;
- c) Import of food.

This information was discovered by researching the sites found and by:

- a) Search Status16 extension for Firefox to detect Google Toolbar Page Rank.;
- b) H1.cz SEO extension17 for Firefox to detect S-rank;
- c) The query "link: required URL" to determine the number of back links of each website in the search engine.

### 3 CONCLUSION

The Czech customer is relatively conservative, distrustful and price-oriented. Many online shoppers are willing to partially sacrifice their convenience (e.g., going to the store, to the post office) to save money. Furthermore, there is still persistent mistrust or insecurity when shopping over the Internet and especially when making online payments in advance. The most difficult step in relation to the customer seems to be the first contact with him or to convince him to make his first purchase. If this online store succeeds, including a hassle-free transaction of merchandise and payment, it is very likely that repeat purchases from the same customer can be expected. A large number of customers orient themselves according to their own experience or recommendations of other persons and at the same time the so-called banner blindness is confirmed. Thus, the less effective forms of promotion such as viral marketing, indirect marketing or SEO seem to be the most effective forms of promotion. At the same time, two groups of customers are profiling highly price-oriented customers willing to compromise on their convenience and, on the other hand, customers who prefer the convenience of buying over a low price. In the distribution area, a differentiated approach to each of these groups is needed, or at least a set of conditions that allows the customer to choose according to his preferences.

#### References

- Akter, S., & Wamba, S. F. (2016). Big data analytics in E-commerce: a systematic review and agenda for future research. *Electronic Markets*, 26(2), 173-194. doi: 10.1007/s12525-016-0219-0
- Awa, H. O., Ojiabo U., & Emecheta, B. (2015). Integrating TAM, TPB and TOE frameworks and expanding their characteristic constructs for e-commerce adoption by SMEs. *Journal of Science & Technology Policy Management*, 6(1), 76-94. doi: 10.1108/JSTPM-04-2014-0012/full/html
- Bandara, T., c Pathiratne, S. (2017). E-Commerce Organization's Information System Necessities. *International Conference on Library and Information Management (ICLIM)*, 2. Retrieved from <http://repository.kln.ac.lk/handle/123456789/17973>
- Baethige, C., & Klier, J. (2016). Social commerce—state-of-the-art and future research directions. *Electronic Markets*, 26(3), 269-290. doi: 10.1007/s12525-016-0225-2
- Boateng, S. (2019). Online relationship marketing and customer loyalty: a signaling theory perspective. *International Journal of Bank Marketing*, 37(1), 226-240. doi: 10.1108/IJBM-01-2018-0009/full/html

- Boysen, N., de Koster, R., & Weidinger, F. (2019). Warehousing in the e-commerce era: A survey. *European Journal of Operational Research*, 277(2), 396-411. doi: 10.1108/IJBM-01-2018-0009/full/html
- Bednářová, D., & Parmová, D. (2010). *Malé a střední podnikání*. České Budějovice: Jihočeská univerzita v Českých Budějovicích Ekonomická fakulta
- Escobar-Rodríguez, T. (2017). Analysing online purchase intention in Spain: fashion e-commerce. *Information Systems and e-Business Management*, 15(3), 599-622. doi: 10.1007/s10257-016-0319-6
- Falk, M., & Hagsten, E. (2015). E-commerce trends and impacts across Europe. *International Journal of Production Economics*, 170(A), 357-369. doi: 10.1016/j.ijpe.2015.10.003
- Fleisch, E., & Weinberger, M. (2015). Business models and the internet of things. *Interoperability and Open-Source Solutions for the Internet of Things*, 6-10. doi: 10.13140/RG.2.1.3824.2008
- Gregory, G., & Karavdic, M. (2017). Developing e-commerce marketing capabilities and efficiencies for enhanced performance in business-to-business export ventures. *Industrial Marketing Management*. doi: 10.1016/j.indmarman.2017.03.002
- Heshmati, S., et al. (2018). Alternative e-commerce delivery policies. *EURO Journal on Transportation and Logistics*, 8(3), 217-248. doi: 10.1007/s13676-018-0120-4
- Hua, N., Hight, S., Wei, W., Ozturk, A. B., Zhao, X., Nusair, K., & DeFranco, A. (2019). The power of e-commerce: Does e-commerce enhance the impact of loyalty programs on hotel operating performance? *International Journal of Contemporary Hospitality Management*, 31(4), 1906-1923. doi: 10.1108/IJCHM-02-2018-0168
- Humair, F. et al. (2015). E-commerce trade in invasive plants. *Conservation Biology*, 29(6), 1658-1665. doi: 10.1111/cobi.12579
- Chao, K. (2016). E-services in e-business engineering. *Electronic Commerce Research and Applications*, 16, 77-81. doi: 10.1016/j.elerap.2015.10.004
- Chen, J. (2016). Facebook C2C social commerce: A study of online impulse buying. *Decision Support Systems*, 83, 57-69. doi: 10.1016/j.dss.2015.12.008
- Communixlab Digital Marketing Academy. (n.d.). *We Teach You How To Do E-Commerce Marketing*. Retrieved from <https://in.pinterest.com/pin/810436895421761340/>
- Hitpass, B., & Astudilo, H. (2019). Industry 4.0 Challenges for Business Process Management and Electronic-Commerce. *Journal of Theoretical and Applied Electronic Commerce Research*, 14(1). doi: 10.4067/S0718-18762019000100101
- Cheung, M. (2016). 28. the e-commerce revolution: ensuring trust and consumer rights in China. *Handbook of Cultural and Creative Industries in China*, 412-430. doi: 10.4337/9781782549864.00040
- Jiang, L., & Minjoon, Y. (2016). Customer-perceived value and loyalty: how do key service quality dimensions matter in the context of B2C e-commerce?. *Service Business*, 10(2), 301-317. doi: 10.1007/s11628-015-0269-y
- Jo, Y., Matsumura, M., & Weinstein, D. (2019). *The Impact of E-Commerce on Prices and Welfare*. Retrieved from <https://www8.gsb.columbia.edu/cjeb/sites/cjeb/files/David%20Weinstein.pdf>
- Košturiak, J., & Gregor, M. (2012). *Jak zvyšovat produktivitu firmy*. Žilina: in-FORM

- Kim, E., McDonald, S. (2018). Development of the food safety labelling technique for applied business in the Vietnamese retail food industry. *Innovare Journal of Food Science*, 6(1), 13-9. Retrieved from [https://innovareacademics.in/journals/index.php/ijfs/article/viewFile/29757/pdf\\_1](https://innovareacademics.in/journals/index.php/ijfs/article/viewFile/29757/pdf_1)
- Kshetri, N. (2018). 5G in E-Commerce Activities. *IT Professional*, 20(4), 73-77. [https://dx.doi.libres.uncg.edu/ir/uncg/f/N\\_Kshetri\\_5G\\_2018.pdf](https://dx.doi.libres.uncg.edu/ir/uncg/f/N_Kshetri_5G_2018.pdf)
- Kumar, N. (2018). E-Commerce in India: An Analysis of Present Status, Challenges and Opportunities. *International Journal of Management Studies*, 2231-2528. doi: 10.1109/MITP.2018.043141672
- Oliveira, T. et al. (2017). Modelling and testing consumer trust dimensions in e-commerce. *Computers in Human Behavior*, 71, 153-164. doi: 10.1016/j.chb.2017.01.050
- Paris, D., Bahari, M., & Noorminshah A. (2016). Business-to-customer (B2C) Electronic Commerce: An implementation process view. *2016 3rd International Conference on Computer and Information Sciences (ICCOINS)*, 19-24. doi: 10.1109/ICCOINS.2016.7783182
- Petit, O., & Velasco, C. (2019). Digital sensory marketing: Integrating new technologies into multisensory online experience. *Journal of Interactive Marketing*, 45, 42-61. doi: 10.1016/j.intmar.2018.07.004
- Piyush, N., & Choudhury, T. (2016). Conversational commerce a new era of e-business. *2016 International Conference System Modeling & Advancement in Research Trends (SMART)*, 322-327. doi: 10.1109/SYSMART.2016.7894543
- Synek, M., Kislíngrová, E. (2010). *Podniková ekonomika*. Praha: C. H. Beck
- Thalassinos, E. I., & Thalassinos, Y. (2018). Financial Crises and e-Commerce: How Are They Related. *SSRN Electronic Journal*. doi: 10.2139/ssrn.3330169
- Tomek, G., & Vávrová, V., (2009). *Jak zvýšit konkurenční schopnost firmy*. Praha: C.H. Beck.
- Trtková, R. (2015). *Analýza konkurenceschopnosti společnosti R&F, a.s.* Zlín: UTB.
- Turban, E. et al. (2018). E-Commerce: Regulatory, Ethical, and Social Environments. *Electronic Commerce 2018*, 573-612. doi: 10.1007/978-3-319-58715-8\_15
- Wang, Ch. et al. (2018). Serendipitous recommendation in e-commerce using innovator-based collaborative filtering. *IEEE transactions on cybernetics*, 99, 1-15. doi: 10.1109/TCYB.2018.2841924

## Contact information

### Mgr. Denisa Mikulová

Tomas Bata University in Zlín, Faculty of Management and Economics  
 Mostní 5139, 76001, Zlín, Czech Republic  
 E-mail: denisamikulova@seznam.cz  
 ORCID: 0000-0002-7198-3644

doi: 10.7441/dokbat.2019.072

# POSSIBILITIES OF NON-REPLICABLE MEASUREMENT SYSTEMS ANALYSIS

*Pavλίna Mikulová*

## **Abstract**

Measurement systems have to deal with processes in which, by the nature of the measured object or by the type of measurement itself, measurements are not repeatable in the sense each sample unit can be measured only once. Such situations are usually referred as non-replicable measurement systems. The paper presents the approaches to gage repeatability and reproducibility (GRR) analysis regarding these cases. On the base of current development in this branch, the special attention is focused on the appropriate setup of GRR analysis and the decision which type of GRR design is suitable to use. The aim of the paper is to map out the current approaches being used in GRR analysis in cases of non-replicable measurement systems. Subsequently, these approaches will be applied at practical experiments of voltammetric measurement. Before the GRR analysis is used for assessing the measurement system acceptability, it is necessary to verify assumptions as consistency, bias and temporal stability of objects. At present, it is desirable to bring the improving actions in order to obtain the results of high quality from non-replicable measurement. The reason is GRR analysis works with two known designs named as “Crossed” and “Nested” design which statistical software normally use. Doubtfully, it is proposed to use crossed design at certain cases and nested at other specific cases. The results show the use of nested design is irrelevant due to deceptive effects of appraisers and the crossed design should be preferred.

*Keywords: measurement, analysis, repeatability, reproducibility, non-replicable measurement*

## **1 INTRODUCTION**

The quality of measurement system is influenced both by the measuring instrument and the measurement system conditions, and the factors including the appraisers who carry out the measurements. The measurement system requires attention and monitoring not to provide distorted information which can lead to wrong decisions. The suitability of a measurement system is an important part of quality planning and quality improvement (Plura, 2001), and it is even strictly required in automotive industry (AIAG, 2006). A set of methods known as Measurement System Analysis (MSA) is used to evaluate a measurement system capability to provide the data of the highest quality. There are various factors that affect the measurement systems and influence the measured values related to the measurement system properties. Therefore, analysing these properties leads to the detection of the causes of low-quality data. The most used analysis of measurement system, which makes possible to evaluate repeatability and reproducibility of measurement system is GRR analysis.

In most cases, the readings of measurement systems can be replicated for each part. This means that parts or samples are not altered by the measurement process, so measurements can be repeated providing comparable data. However, not all measurement systems have this characteristic. This is the case of non-replicable measurement systems where the part is altered or even destroyed during the measurement. In statistics, a replicable measurement system is one where any given part may be measured multiple times by the same or different appraisers and the result obtained falls within a predictable range of values (Miner, 2016).



One of the essential properties of measurement system is its consistency. A consistent measurement process is in statistical control with respect to variation. Moreover, bias and stability of the measurement system is necessary to meet. The bias refers to the location of the data relative to a reference value; presents the difference between the observed average of measurements and the reference value. The stability is the change in bias over time. A stable measurement process is in statistical control with respect to location.

## **2 NON-REPLICABLE MEASUREMENT SYSTEMS**

As mentioned, normally in measurement systems, the readings can be replicated for each part. Though, this is not the case of non-replicable measurement systems divided into (MSA Work Group, 2010): (a) Destructive measurement systems; and (b) Systems where the part changes during measurement process. In these cases, different appraisers cannot measure the same part nor does each appraiser obtain successive measurements of this part. This restriction impacts the experimental design to be used as well as the GRR analysis approach (Miner, 2016). Two approaches are usually considered: (a) Crossed GRR analysis; and (b) Nested GRR analysis. Software tools, as Minitab, offer these options to practitioners. Section 3.1 deals with this issue in more detail.

### **2.1 Destructive measurement systems**

In terms of destructive measurements, the part is changed or destroyed during the measurement process. Thus, different appraisers cannot measure the same parts neither repeated readings cannot be taken on any single part, e.g. destructive weld testing, destructive plating tests, salt spray or humidity booth testing, impact testing (gravimeter) or mass spectroscopy and other material characteristic testing processes (Ermer, 2006).

Following are the advantages of destructive measurements (LTI Group, 2019): (a) Allow identifying the mechanical properties of material (fracture strength, elongation, modulus of elasticity etc.); (b) Predict the approximate nature of failure or breakdown that may occur during the lifetime of the product use; (c) Verify e.g. the surface preparation, curing conditions, working conditions and system products. Furthermore, the destructive measurements have some disadvantages must be mentioned: (a) Costs and time-consuming method; (b) Harder to ensure the consistent measurement process (a sample cannot be re-measured once have been tested.); (c) Provide limited options of analysing the obtained data (see section 3.1.).

There are some cases where the part itself might be destroyed, but the measurement is still replicable. This may occur if the part must be damaged to gain access to the characteristic to be measured. Once access is gained the characteristic may be measured repeatedly.

### **2.2 Systems where the part changes during measurement**

There are other non-replicable measurement systems where the part itself is not destroyed by the measurement process but the characteristic being measured changes, e.g. Leak tests with qualitative data, testing using engine test stands, transmission test stands, vehicle dynamometers, torque measurement etc. (MSA Work Group, 2010). According to (Miner, 2016) these systems are divided to the follows, when: (a) Part changes during measurement process (rubber parts soften when flexed or harden when left alone; uncured rubber cures when tested in a rheometer); (b) Measured characteristic changes over time (dimensions of freshly moulded plastic parts, viscosity of materials with shelf lives); (c) Part cannot be physically reintroduced to the measurements (in-line measurement devices); (d) The part cannot be re-measured in the same location (e.g. hardness test).

Analysis of these systems depends on whether (MSA Work Group, 2010): (a) homogeneous set of parts (small between part variation) can be found to represent a single part; (b) the shelf life of the characteristic is known and extends beyond the expected duration of the study (i.e. the measured characteristic does not change over the expected period of use); (c) the dynamic (changing) properties can be stabilized.

On the base of current state in non-replicable measurement systems, it is necessary to focus on the possible analysis of the data obtained from this kind of measurements. Then, it is required to realize, which way is the appropriate to stabilize the measurement process and make it consistent. The attention is focused on appropriate setup of GRR analysis considering the number of samples, appraisers and measurements, so that it is the compromise between the requirement for obtaining the highest quality results and the requirement for minimum financial and time-consuming performance of this analysis. The further important decision is which type of GRR designs to use from both described in section 3.1.

### 3 GAUGE REPEATABILITY AND REPRODUCIBILITY ANALYSIS

Since measurement systems are to be used in making decisions about products, processes, or services, an analytic conclusion about the measurement system is necessary. The transition from enumerative to analytic results requires subject matter knowledge and expertise to assure that all expected measurement sources of variation are considered in the design (MSA Work Group, 2010).

The realization of a measurement under the same conditions is impossible. The conditions are changeable what is mostly caused by the change of operator performing the measurement. In general cases, two major sources of measurement system variability are repeatability and reproducibility, see Fig. 1 (Plura, 2012).

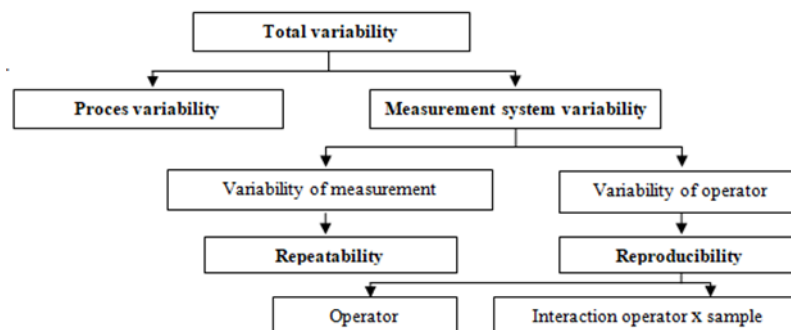

Fig. 1 – Total variation layout of measured data. Source: Sonooch, Kiatcharoenpol & Laosirihongthong (2007)

Various approaches can be used to evaluate repeatability and reproducibility; the most used are Average and Range (A&R) method or ANOVA (MSA Work Group, 2010). Average and Range method uses subgroups of data to determine the variance due to the various sources of variation. Applying this method the variation induced by repeatability or reproducibility can be distinguished. It does not take into account the operator-part interaction.

ANOVA is a technique that examines what sources of variation have a significant impact on results. This approach actually adds another source of variation to the mix and it is able to identify the operator-part interactions (Plura, 2012). Thus, GRR study is a designed experiment to study the variation in measurement results. The experiment is design to determine how much variation is due to the measurement method and how much is due to the appraisers. This is performed by measurements of parts from the process and analysed by methods of GRR study.

### 3.1 Designs to assess the non-replicable measurement system

If the part is altered or destroyed during the measurement process, it is not possible to just select parts from the process and have each appraiser measure each part. Hence at this point, working with the batches is necessary. Batch is considered one of the kinds described in section 4.1. For assessing the non-replicable measurement systems, crossed and nested GRR design are known. Which one of these to use is shown in Fig. 2.

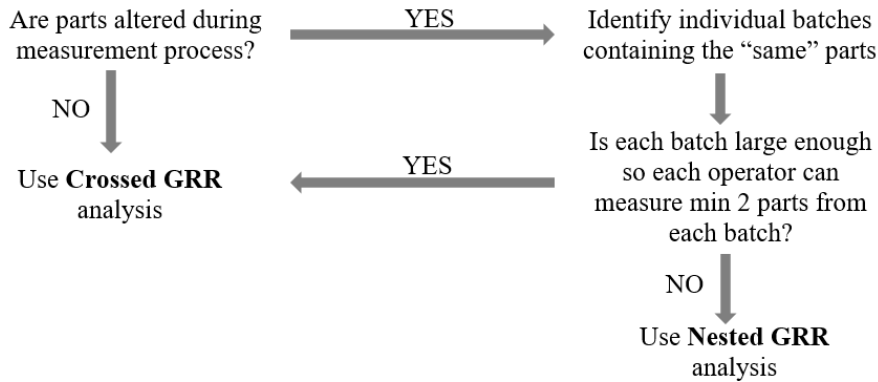

Fig. 2 – Selection of GRR design. Source: McNeese (2016)

As for crossed GRR design (Fig. 3), conducting GRR analysis of non-replicable measurement system requires making a critical assumption – to identify a batch of parts where the parts are so close to being alike that those in the batch are the “same“. Thus, the assumption is that the batch is homogeneous (McNeese, 2016). This means measuring any part of the batch for the same characteristic, its results should be similar with a small sign of variation due to repeatability same as it occurs in the replicable measurement system. Unlike the crossed design considering replicable measurement systems, the same part is really being measured more than once, i.e. repeatedly. In reality, the variation is due to the measurement system repeatability in both cases. If a large amount of variation occurs in non-replicable measurement, then the question is whether the batch is really homogeneous.

In nested GRR design (Fig. 3), the difference occurs at the stage when determining if there is a sufficient number of parts to measure from each batch for each operator. In the cases where are not enough parts in each batch for each operator to measure multiple times, the nested GRR design is recommended to use.

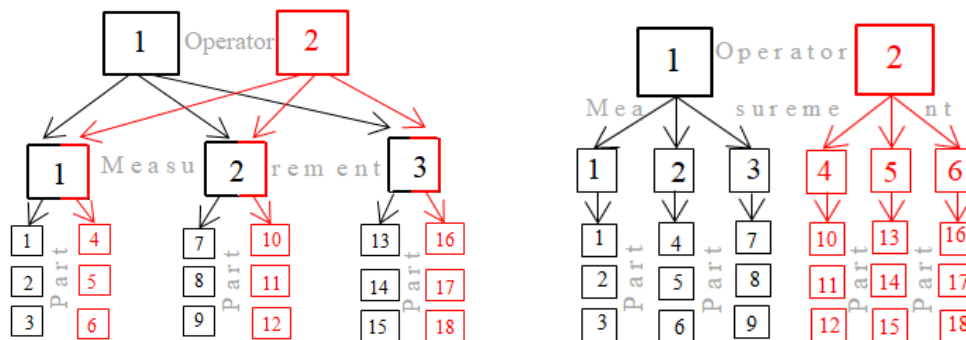

Fig. 3 – Crossed and nested GRR design. Source: Jarošová (2018)

De Mast and Trip (De Mast et al., 2005) claims that the option of the nested design may result in misunderstanding. Under the assumption of objects homogeneity the crossed design could be used, but with repetitive measurements on single objects replaced with measurements on different objects. The appraiser selects  $I$  parts of  $JK$  objects each, which are assumed homogeneous. Each of  $J$  operators measures  $K$  of these objects once. The effect of the  $JK$

objects of a sample is nested within the operators factor, which might be the reason of that so many courses refer to this design as being nested. Although, the samples of the batch which are measured by the operator are nested within their combination, in fact, the batches are crossed with operators. The name of Nested is somehow delusive since the samples factor is still crossed with the operators' factor, whereas the objects' factor – though it is indeed nested – does not show up in the process. According to McNeese (2016), ANOVA allows analysing the results of a nested GRR design provided by software Minitab and it really does, but, it is claimed A&R method cannot be used. Let's see the methodology of non-replicable measurement systems analysis and, subsequently, we will try to verify this.

## 4 METHODOLOGY OF NON-REPLICABLE MEASUREMENT SYSTEMS ANALYSIS

Now, having a non-replicable measurement system, the following approaches are recommended to use in order to perform optimal measurement system analysis and gain knowledge with similar results as the results obtained from such system with replicable measurements (Miner, 2016). At first, it is shown how to properly prepare the samples to be subjected to GRR analysis. Afterwards, the analysis procedure of non-replicable measurement is characterized.

### 4.1 Methods of sample preparation for non-replicable measurements

The following are methods of samples preparation recommended by cases of non-replicable measurements:

**Split samples** – the parts or material collected to represent one part are split or subdivided into smaller units. The smaller units are used for the repeat trials and between appraiser trials (e.g. a steel bar is cut out for smaller parts). According to MSA Work Group (2010), variability study V3 and V4 can be used based on this type of measurements.

**Consecutive samples** – consecutive parts are used to represent one part for the repeat trials and between appraiser trials. This way is used when the parts cannot be subdivided and consecutive parts can reasonably be expected as homogeneous as if they occurred in an auto-correlated process. Using consecutive parts, the V3a and V4a study are used following MSA Work Group (2010).

**Stabilized parts** – parts or systems are stabilized before measurement process. This stabilization depends on the product and characteristic. Some characteristics may stabilize when a number of times pre-measured.

**Regression approach** – when the change in the characteristic over time or activity is known and has a defined relationship [ $Y=f(x)$ ] (e.g. shrinkage of plastic parts), the subsequent measurements are adjusted using this relationship and then analysed.

### 4.2 Assumptions for proper GRR analysis application

One of the important questions is how to monitor the consistency of a non-replicable measurement system over time. In other words, how to ensure that the repeatability of the non-replicable measurement is the “same” over time. This is simple to do for replicable measurement systems. Using a standard or a reference part, we can use  $\bar{X}$  and  $R$  control chart (if the standard is measured  $K \geq 2$  times in each cycle) or Individual  $\bar{X}$  and moving  $R$  chart (if the standard is measured once in each cycle). From the  $\bar{X}$  or individual  $\bar{X}$  chart the measurement process stability (bias constancy over time) can be controlled. From  $R$  or moving  $R$  chart the measurement process consistency (repeatability constancy over time) can be controlled. The

way how to analyse consistency of a non-replicable measurement is to use the approach of samples multiplication. These are simply multiplied samples in lots of  $K$  which are the “same”. They are not identical, but they are as close as possible to being alike. The range represents the variation in the method of non-replicable measurement. The variation of non-replicable measurement consistency is the variation in the results between  $K$  samples. Generally, the consistency is considered to be the degree of repeatability change over time (McNeese, 2015).

Reference Manual MSA fourth edition presents S4 and S4a study used in this case, where S4 represents the study of Split samples (general) or Single sample per cycle, and S4a study is the same as S4 with pairs of consecutive (homogenous) parts from different lots. It is an upper bound study. Further, the assumptions for temporal stability of objects should be met that means it does not matter at which time the samples are measured. If this is not met, there are some alternatives which can be used, see De Mast and Trip (2005).

### 4.3 Determination of variance components by GRR analysis

Meeting the assumptions is the first essential step to ensure a well-working measurement system. Further important point is to be aware of the factors being investigated – part and operator. In general cases, a complete factorial design with replications includes  $I$  parts and  $J$  operators, each operator measures each of  $I$  parts  $r$  times. Considering the recommended procedure for operators to proceed to the next measurement of the same part after all  $I$  parts have been measured, it is appropriate to consider the layout of blocks made up of individual replicas (Jarošová, 2018). The model has following form:

$$y_{ijk} = \mu + p_i + o_j + (po)_{ij} + b_k + e_{ijk} \quad (1)$$

$i=1,2,\dots,I; j=1,2,\dots,J; k=1,2,\dots,r$

where  $\mu$  is the overall mean,  $p_i$  is the effect of part  $i$ ,  $o_j$  is the effect of operator  $j$ ,  $(po)_{ij}$  is the effect of interaction between part  $i$  and operator  $j$ ,  $b_k$  mean random effect of block  $k$  and  $e_{ijk}$  represents the random element. Normally, it is assumed the results are not influenced by the block (measuring time), therefore the model without the blocking factor is used:

$$y_{ijk} = \mu + p_i + o_j + (po)_{ij} + e_{ijk} \quad (2)$$

The task is not to compare the particular parts or operators participating in the experiment, but to measure the variability between different parts and operators in general by assuming that  $p_i$ ,  $o_j$ ,  $(po)_{ij}$ ,  $e_{ijk}$  are mutually independent and normally distributed random variables with zero means and variances  $\sigma_p^2$ ,  $\sigma_o^2$ ,  $\sigma_{po}^2$  and  $\sigma^2$ . Then, the variance of response  $Y$  can be demonstrated:

$$\sigma_t^2 = \sigma_p^2 + \sigma_o^2 + \sigma_{po}^2 + \sigma^2 \quad (3)$$

The aim of GRR analysis is to determine the components of variance due to the measurement system  $\sigma_{GRR}^2$  and compare it with total variance ( $\sigma_t^2$ ):

$$\sigma_{GRR}^2 = \sigma_o^2 + \sigma_{po}^2 + \sigma^2 \quad (4)$$

where  $\sigma^2$  represents repeatability (EV)<sup>2</sup> and  $\sigma_o^2 + \sigma_{po}^2$  reproducibility (AV)<sup>2</sup>.

Finally, considering GRR analysis for crossed design use, where parts with repeated measurements are replaced by batches of similar samples, slight changes will be made in the equations. The change will be in replacing “ $p$ ” by “ $b$ ”, i.e. batches instead of parts:

$$y_{ijk} = \mu + b_i + o_j + (bo)_{ij} + e_{ijk} \quad (5)$$

Thus, the study consists of  $J$  operators and  $I$  batches of homogenous parts (each batch formed by  $J \times r$  parts). The  $r$  blocks mean each operator measures once  $I$  part from each batch and each block.

Several methods for estimate the variance components exist. Best-known methods are ANOVA, ML (Maximum Likelihood) or REML (Restricted Maximum Likelihood). ANOVA estimators of all variance components are unbiased and have the smallest variance of all estimators which are both quadratic functions of the observations and unbiased. This is the case of balanced data (Searle, Casella & McGulloch, 1992). Assuming normal distribution, the estimators are minimum variance and unbiased. If the distribution of estimated variance components with exception of the estimate  $\sigma^2$  cannot be described by any theoretical model, the exact confidence limits for  $\sigma_{GRR}^2$  cannot be found. There are three methods presented in (Jarošová, 2018) for constructing approximate confidence limits which can be used. However, the disadvantage of ANOVA is that it can give negative estimates of variance components. From the statistical point of view, the way of estimate is not definite if some of the estimates are negative.

As stated in section 3.1, the nested GRR design provided by software tool Minitab is not suitable for GRR analysis due to the delusive effects of appraisers' factor and differences between batch groups assigned to them. The obstacle occurs when comparing the differences between appraisers. The crossed GRR design is preferred, though, it signifies to ensure the sufficient amount of samples being measured. Thus, the experiment presented in chapter 5 will deal with crossed GRR design.

### 5 RESULTANT DESIGN OF MEASURING THE OXYGEN AVAILABILITY IN CONCRETE

Measurement being performed in order to verify the capability of non-replicable measurement system relates the process of measuring the oxygen availability in concrete prisms. The four types of concrete are used and measured by two operators in experiment. These types represent the batches. From each concrete type, the twelve homogenous samples have been produced for measurement. Each operator can measure each part repeatedly (see Fig. 4) and maintains the repeatability and reproducibility same as in the case of replicable measurement system. These types (batches) differ in the ratio of water to cement (w/c), following are the ratios used for preparation of measured samples: (1) Batch consists of the samples with w/c ratio equal to 0.6; (2) Batch consists of the samples with w/c ratio equal to 0.5; (3) Batch consists of the samples with w/c ratio equal to 0.4; and (4) Batch consists of the samples with w/c ratio equal to 0.5sf. A part of the cement is replaced by silica fume.

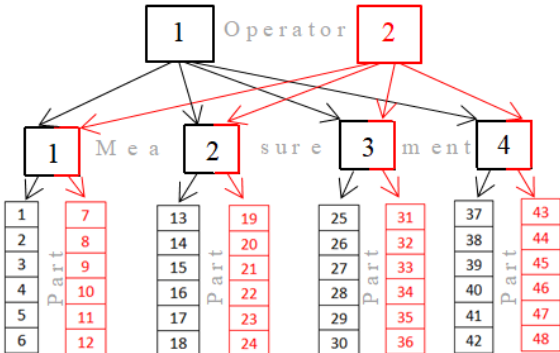

Fig. 4 – Crossed GRR design used for experiment. Source: own research

In terms of the measurement conditions, the operational pressure is adjusted on 0 mbar (vacuum) and 1000 mbar (atmospheric condition). The electrodes with the same working surface, the diameter of 0.08mm and length of 12cm are used. Next, the temperature is considered to be equal to the lab temperature, ca. 20°C and the relative humidity to be 80% (Brownson & Banks, 2014).

## 6 DISCUSSION THE MEASUREMENT OF OXYGEN AVAILABILITY

The measurements are based on principle of voltammetric methods, specifically Cyclic Voltammetry (Van Brussel et al., 2003) and Electrochemical Impedance Spectroscopy (Correia et al., 2006). In voltammetric methods, the range of potentials are scanned where the generated current is directly proportional to the concentration of electroactive species present in the sample (Mistry et al., 2014). Impedance spectroscopy measures the resistance and capacitance properties of a material. An impedance spectrum is obtained by varying frequency over a defined range. The capacitance and resistance of the system can be then calculated by measurement of the in-phase and out-of-phase current responses (Correia et al., 2006). After all the measurements will be performed by using the stated method, following facts are need to consider for the purpose of analysing the non-replicable measurement:

**Nested GRR design is not suitable** enough for analysing the nonreplicable measurements. Use of nested design is marked as deceptive because it is influenced by the facts that the samples factor is still crossed with the operators' factor and the (nested) objects factor does not show up in the process.

**Crossed GRR design is preferable**, nevertheless, it signifies to ensure the sufficient amount of samples (2 or 3 times more as commonly used in replicable measurements).

Hence, use of crossed design will be verified within ongoing experiment by using ANOVA and A&R method. So far, the information found seem to be contradictory and need to be verified since there is still lack of evidence.

## 7 CONCLUSION

On the base of current development in the designs of GRR study for non-replicable measurement systems, the conclusion is that the nested GRR design is not suitable for GRR analysis in terms of final evaluation of measurement system acceptability. The crossed GRR design is admittedly more suitable for GRR application, even though, the number of measured samples must be significantly higher. The GRR analysis for non-replicable measurement systems can provide an evidence of satisfactory measurement system if the total gage variance  $\sigma_{GRR}^2$  is low. On the contrary, if the gage variance is high (the components are influenced by sample-to-sample variation), nothing can be concluded. In spite of the fact this situation of high total gage variance may occur, according to meeting the mentioned assumption, it is possible to ensure the consistent and stable measurement process as well as the case of replicable measurement system. This is the sign to reach just the low total gage variance.

### Acknowledgment

The work has been supported by the specific university research of the Ministry of Education, Youth and Sports of the Czech Republic No. SP2019/62 and elaborated in the framework of the grant programme „Support for Science and Research in the Moravia-Silesia Region 2018" (RRC/10/2018), financed from the budget of the Moravian-Silesian Region.

## References

- AIAG (2006). *Production Part Approval Process (PPAP)*. Chrysler Group LLC, Ford Motors Corporation.
- Brownson, D. A. C., & Banks, C. E. (2014). *The Handbook of Graphene Electrochemistry*. London: Springer.
- Brussel, V. M, Kokkinidis, G., Hubin, A., & Buess-Herman, C. (2003). Oxygen reduction at platinum modified gold electrodes. *Electrochimica Acta*, 48, 3909-3919. doi: 10.1016/S0013-4686(03)00529-2
- Correia, M. J., Pereira, E. V., Salta, M. M., & Fonseca, I. T. E. (2006). Sensor for oxygen evaluation in concrete. *Cement & Concrete Composites*, 6, 226-232. doi: 10.1016/j.cemconcomp.2006.01.006
- De Mast, J., & Trip, A. (2005). Gauge R&R Studies for Destructive Measurement. *Journal of Quality Technology: A Quarterly Journal of Methods, Applications and Related Topics*, 37(1), 40-49. doi: 10.1080/00224065.2005.11980299
- Ermer, D. S. (2006). *Measure for Measure: Appraiser Variation in Gage R&R Measurement*. Retrieved from <http://asq.org/quality-progress/2006/05/measure-for-measure/appraiser-variation-in-gage-rr-measurement.html>
- Jarošová, E. (2018). *Destructive R&R study – evaluation problems*. Paper presented at the 17th Conference on Applied Mathematics APLIMAT 2018, Bratislava, Slovakia. Bratislava: Slovak University of Technology in Bratislava.
- LTI Group (2019). *Materials testing, non-destructive testing & calibration services: Destructive Testing: Providing Samples for Analytical Testing*. Retrieved from [www.labtesting.com/wp-content/uploads/2012/12/company\\_testing\\_brochure.pdf](http://www.labtesting.com/wp-content/uploads/2012/12/company_testing_brochure.pdf)
- McNeese, B. (2015). *Monitoring Destructive Test Methods*. Retrieved from <https://www.spcforexcel.com/knowledge/measurement-systems-analysis/monitoring-destructive-test-methods>
- McNeese, B. (2016). *Gage R&R for Non-Destructive and Destructive Test Methods*. Retrieved from <https://www.spcforexcel.com/knowledge/measurement-systems-analysis/gage-rr-for-non-destructive-and-destructive-test-methods>
- Miner, G. (2016). *Intro to MSA of Continuous Data – Part 6: R&R for Non-Replicable Measurements*. Retrieved from: <http://www.qualityforumonline.com/forum/index.php?resources/intro-to-msa-of-continuous-data-%E2%80%93-part-6-r-r-for-non-replicable-measurements.40/>
- Mistry, K. K., Layek, K., Mahapatra, A., RoyChaudhuri, C., & Saha., H. (2014). A review on amperometric-type immunosensors based on screen-printed electrodes. *Analyst*, 139(10), 2289-2311. doi: 10.1039/c3an02050a
- MSA Work Group (2010). *Measurement System Analysis, Reference Manual*. Chrysler Group LLC, Ford Motors Corporation.
- Plura, J. (2001). *Quality Planning and Continuous Quality Improvement*. Prague: Computer Press.
- Plura, J. (2012). *Quality Planning II*. Ostrava: VSB-Technical university of Ostrava.
- Searle, S. R., Casella, G., & McGulloch, C. E. (1992). *Variance component*. New York: Wiley.



Sonooch, S., Kiatcharoenpol, T., & Laosirihongthong, T. (2007). *An Approach to Compare Measurement System Analysis and Process Capability Study for Prioritizing Improvement*. Paper presented at the 9th International DSI Conference. Bangkok: InterDSI. Retrieved from: [http://gebrc.nccu.edu.tw/proceedings/APDSI/2007/papers/Final\\_113.pdf](http://gebrc.nccu.edu.tw/proceedings/APDSI/2007/papers/Final_113.pdf)

### **Contact information**

#### **Ing. Pavlína Mikulová**

VSB-Technical University of Ostrava, Faculty of Materials Science and Technology

17. listopadu 15, 70833, Ostrava – Poruba, Czech Republic

E-mail: [pavlina.mikulova.st@vsb.cz](mailto:pavlina.mikulova.st@vsb.cz)

ORCID: 0000-0002-2035-029X

doi: 10.7441/dokbat.2019.073

# SUCCESSION IN FAMILY BUSINESSES IN SLOVAKIA

*Jarmila Mižičková, Michal Levický*

## **Abstract**

The history of family business in Slovakia began to be written shortly after 1989, which was the beginning of the transformation of the economy. Family businesses in our conditions are starting to solve the succession issues only now. Our contribution is focused on the evaluation of the current state of family business in Slovakia with an emphasis on the succession stage in this category of enterprises. Based on a questionnaire survey conducted on a sample of 276 family businesses, we can state interesting facts about the succession issues in this category of businesses. Based on the questionnaire survey, we found out that most companies are often confronted with the problems of transferring assets to the second generation, with doubts and distrust customers and ultimately with inexperience and lack of practice within the second generation. We have found that the generational exchange of family businesses in Slovakia is predominantly patriarchal in nature. The succession is decided mainly by the father, husband or man who manages the business. We used primary and secondary data in the article. We obtained the primary data through a questionnaire survey. The obtained data were analysed by appropriate statistical tests. Secondary data were scientific articles and contributions on family business issues, as well as data obtained from SBA, PSA and KPMG reports.

*Keywords: family businesses, succession, Slovak Republic, small and medium enterprises*

## **1 INTRODUCTION**

In the world, the success of family businesses is not measured by profit or revenue, but is judged by the number of generations that have successfully mastered the succession process. Therefore, family businesses in Slovakia should also focus on the long-term existence. Generational change in a family business must be prepared well in advance, as it is one of the most risky phases of the life cycle and the future of the business also depends on it (Lušňáková et al., 2019). An important piece of knowledge in the field of succession is the preparation of the transition to the younger generation, which is intensifying with the increasing age of the founders. Especially as they approach retirement age, they are trying to ensure the transition of all or most of the processes to the younger generation. These arguments are confirmed by the fact that young family members have space in the company for possible future activities and even in some cases adjust their education beforehand. Education of descendants according to the older generation can be an advantage and support the business, but they consider working experience above all to be important for business continuation (Papula et al., 2018). Despite creating the conditions for an intergenerational transition, the older generation is concerned about succession arising from possible damage to family relationships and the possibility that there will be anyone to take over the business, especially if the type of business requires special education-related certificates. The older generation considers submitting the business to be the most important moment of family business, which is in line with the opinion of the young generation. The aim of the paper is to obtain information on generational exchange in Slovak family companies and then, on the basis of this information, to diagnose the nature of the change of inheritance and to propose measures that would lead to mitigation of risks associated with generational exchange.

## 2 THEORETICAL BACKGROUND

An entrepreneur can become economically independent, gain social status, gain freedom and decide on his activities voluntarily and independently. Entrepreneurship allows other family members to be involved in their activities. On the one hand, business provides economic freedom, but on the other hand responsibility for all actions and activities (Papula et al., 2018). Most business units belong to the category of small and medium-sized enterprises and therefore constitute one of the most important components of the whole economy. Small and medium-sized enterprises are often considered as important innovators, especially in the economic sector (Kitching & Blackburn, 1998). According to Solíková (2013), one of the most important positions in the European Union economy is played by small and medium-sized enterprises, especially in the areas of economic growth and employment. Most small and medium-sized enterprises are active only in their home country. Only a small part of them participate in cross-border activities. At first sight, small and medium-sized enterprises appear to be some space in which enterprises of a particular category operate only temporarily. (Papula et al., 2015). Naturally, a large part of them tend to grow and gradually move into the category of large enterprises throughout their life cycle. A significant part of small and medium-sized enterprises not only in Slovakia, but also in other countries, consists of family businesses and family business. Family business in the Slovak Republic since the beginning of its existence has problems with legislation, even though the problems of family businesses are quite common nowadays, but in this segment of business is paid little attention (Koráb & Murínová, 2017). The importance of family businesses increases with internationalization and is related to business success in global market conditions. Small and medium-sized enterprises are also important in reducing regional disparities (Odehnalová & Pirožek, 2015). It is very difficult to define a family business. The legislation of Slovak Republic does not know this term. In general, however, we can speak of a family business if the business is owned by a family member, the family business is managed by a family member or descendant of the founder. (Hudáková et al., 2014). If the family business is also to be legally different, a legislative framework is needed in which the specifics and rules under which family businesses are established and operate are also incorporated. Currently, the legislation does not define the legal forms of family business. Therefore, family businesses in Slovakia are managed according to valid general legislation. However, in developed market economies, family business is associated with the following legal forms (Papula et al., 2018): (a) family business of self-employed or self-employed farmer; (b) family business type of business company; and (c) family cooperative (family farm).

Koráb and Murínova (2018) define family businesses as being owned by a group of people in a family relationship. The basis of family business in Slovakia is a joint business of family members and succession in a family business. From the legal point of view, the rules defined in the Civil Code apply to this joint venture of family members. The situation is different in the Czech Republic, where since 2014 the new Civil Code introduces for the first time the institute of family business (Janků, 2017). Since then, a family business in the Czech Republic is considered to be a business where the spouses or at least one spouse and their family work together up to the third stage. Those, who work permanently for the family business are viewed as family members, who participate in the management of the family business. The provisions on the rights and obligations of family members who take part in the management of a family business shall not apply where such rights and obligations are governed by a memorandum of association, including a memorandum of incorporation, a silent partnership or a contract and provisions of another law on employment, or other similar contract. Given the historical development that did not allow private ownership in the Communist period, entrepreneurs are facing a whole new challenge of transferring their family businesses to the new generation

(Hodinková, Horák & Vincencová, 2016). When moving to the next generation, it is essential to have a plan ready, which in a family business can be complicated because of relationships and emotions. The founder hands on lifelong works and requires great confidence from the younger generation. Perhaps this is one of the reasons why more than 70% of family businesses do not survive the transition from the founder to the second generation.

### **3 METHODOLOGY**

The aim of this paper is to diagnose the importance and status of family business in Slovakia and to analyse the process of generational exchange in family businesses, which is an important factor in the long-term success of a family business. The importance of knowing the specifics and problems of succession lies in the fact that succession is a sensitive stage in the life of any family business whose failure can mean its disappearance. Both primary and secondary data were used to assess the current state of affairs. The primary data were obtained through a questionnaire survey. The sample consisted of 278 respondents after initial adjustment and withdrawal. The survey was conducted in autumn 2018. The aim of the questionnaire survey was to obtain information on family business in Slovakia and to find out obstacles to family businesses in their further development. The questionnaire covered several areas of business. In addition to the basic characteristics, we focused on the issues of family business management, succession and financing. The respondents were persons who somehow participated in the management of the business, which can be considered a family business. All participating enterprises belonged to the group of small and medium-sized enterprises. The authors tried to use a stratified proportional sample when including companies in the sample. The basis was the criterion – place of business based on the classification of regions NUTS III level. The obtained information was processed by means of selected statistical methods at the significance level of 0.05. The secondary data we used in our paper comes from official statistics of the Ministry of Economy, Slovak Business Agency and KPMG, but also from the academic community in the form of studying scientific studies and articles.

### **4 RESULTS**

#### **4.1 Current view of the problem of succession in family businesses in Slovakia**

Despite the fact that family businesses are crafted from small and medium-sized enterprises, which are considered to be the driving force of the whole economic growth of Slovakia, are considered as carriers of innovation and employ the most people, they still belong to topics that do not pay enough attention. This is also evidenced by the lack of a uniform definition of family business. In Slovakia, public institutions have not been interested in this form of business for a long time, despite the fact that family businesses account for about 70 to 90% of economic growth (Slovak Business Agency, 2018). Within the family business life cycle, one of the key areas is considered a generation change, which is also one of the critical phases of the whole family business. Replacement of family members who run a business may result in a legislative change in ownership of the business. The new management is confronted with the need to engage in all business activities, while it is important that the change in management is also accepted by employees. Another aspect is to maintain coherence in the area of business vision as well as business relationships with suppliers and customers. Businesses should prepare for the succession process in the long term, from successor decisions, through the gradual transfer of all experience to the gradual assumption of competence. In older economies, the success of family business is measured and judged by how many generations have gone through this process. In our conditions, this indicator is inaccurate and distorted by the fact that family businesses are relatively young. One group of family businesses in Slovakia consists of

enterprises that the first generation built from the ground up and during this period the first generation replacement should take place. The second group consists of family businesses, which the first generation acquired by privatization and only now the second generation takes over. According to the survey (Figure 1) of Barometer of family business in Europe carried out by KPMG and European Family Businesses in 2018: (a) approximately 72 % of the companies involved in Barometer is owned by the founder generation, who still work actively in the company, of which more than half are considering submit it to the new generation; (b) approximately 27% of family businesses have already passed the succession process and second generations are already in charge; and (c) approximately 1% of all family businesses have even passed the succession process and the third generation is in the business leadership.

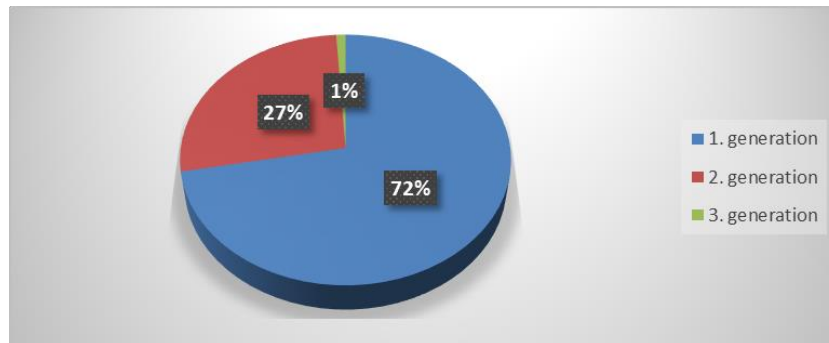

Fig. 1 – Which generation manages family businesses today? Source: Slovak Business Agency (2018)

As we can see such a large part of Slovak family companies had to deal with the question of succession and generational exchange. However, according to the results of the barometer, a large part of family businesses are still waiting for the generation, therefore it is necessary to constantly improve the generation exchange processes, which will focus on mitigating the risks associated with generational exchanges.

#### 4.2 Perception of the problem of succession from the perspective of family businesses

By means of a questionnaire survey, which was specifically focused on small and medium-sized enterprises and at the same time family enterprises in Slovakia, we also found out the perception of these enterprises on selected issues of succession. Respondents were asked questions related to succession in their family business. In the first throat we found out whether there was a succession of the second or third generation in the company. If so, we found out who specifically became a successor. We also found out who decided on succession. In this part of the questionnaire, we also asked an open question, which was aimed at examining the problems that companies encountered in eventual succession.

The basic question was to find out whether the company had a succession of the second or third generation. A total of 35 enterprises (12.59% of the total number of enterprises) reported succession in their enterprise. Only in 20 cases the successor was a son and in 6 cases it was a daughter and therefore if the succession occurred in the company up to 74.29% of the cases were direct descendants. Regarding the decision on succession itself, it can be stated that the patriarchal nature of family business is maintained, as up to 77.14% of companies stated that the succession was decided by the father, respectively husband. In an open question, respondents had the opportunity to indicate what problems they had encountered in succeeding in their family business. Twelve respondents (34.28% of the successors) stated that the succession did not have any problems in their case. The remaining respondents reported several problems that they had to solve. The most common representatives of family businesses referred to three problems associated with succession in their businesses. The first problem was the method of transferring property to the second generation. The second problem was the fact that

doubts arose on the part of customers or the change was not accepted by customers. The third often mentioned problem was inexperience and lack of second generation practice.

In the case of succession, very often the problem is the autocratic approach of individuals who are not accepted by potential successors. We observed the dependence of the form of succession decision (individual vs. collective) and the existence of conflicts and disputes in the family business. The data were analysed using the procedures defined in the methodology section. The dependence between these qualitative features could not be confirmed on the required level of significance.

## 5 CONCLUSION

The history of family business in Slovakia began to be written shortly after the velvet revolution. Family businesses in our conditions are starting to solve the succession issues only now. In older economies, the success of family business is measured and judged by how many generations have gone through this process. In our conditions, this indicator is inaccurate and distorted by the fact that family businesses are relatively young. Based on a questionnaire survey conducted on a sample of 276 family businesses, interesting facts can be stated about succession issues in this category of enterprises. If succession took place in the company, up to 74.29% of the cases concerned the takeover of the company by direct descendants, in most cases the son. The patriarchal nature of family business is reflected in the fact that the way of succession is decided by the father, the husband or the man at the head of the business in the passing generation. In the context of family business support, specifically in the risk phase of succession, it is important to know the problems businesses face. From the questionnaire survey we found that companies are most often confronted with problems in transferring assets to the second generation, with doubts and distrust of customers, and finally with the inexperience and lack of second generation practice.

Generational exchange is a sensitive stage in the life of a family business. Incorrect handling or problems during the exchange may jeopardize the existence of the business. The aim of the survey was to obtain rare data on family business in Slovakia and special data on succession issues. On the basis of the data obtained, it is possible to diagnose the characteristic features of the succession and, based on the identified obstacles and problems, to propose measures to reduce the risk of generational change. The limitations of our research are in the quality and size of the questionnaire survey as well as the fact that the questions assessing the generation change are qualitative and the answers are subjective. This should be taken into account when formulating the conclusions. We have found that family businesses perceive the difficulties in transferring wealth between generations, the negative perception of exchange by customers and ultimately the inexperience of the next generation as obstacles to generational exchange. All three obstacles represent areas of further research in that area. It has to be said that how a company manages a generation change depends mainly on itself. However, in the area of the transfer of company assets, we see room for legislative support of the state. The field of perception of exchange by customers can be partially solved by using appropriate communication and marketing methods.

## References

Hodinková, M., Horák, R., & Vincencová, E. (2016). *Family business succession and its tax effects in the Czech Republic*. Paper presented at 27th IBIMA conference on Innovation Management and Education Excellence Vision 2020: From Regional Development

- Sustainability to Global Economic Growth, Milan, Italy. International Business Information Management Association, 1394-1402.
- Hudáková, M., Mižičková, J., Válková, D., Mikoláš, Z., & Fialová, V. (2014). *Rodinné podnikanie: Teória a príklady z praxe*. Bratislava: Wolters Kluwer.
- Janků, M. (2017). Legal and Economic Context of the Czech Civil Code Rules on Family Enterprises. *Acta Universitatis Agriculturae et Silviculturae Mendelianae Brunensis*, 65(6), 1945-1951. doi: 10.11118/ACTAUN201765061945
- Kitching, J., & Blackburn, R. (1998). Intellectual property management in the small and medium enterprise (SME). *Journal of Small Business and Enterprise Development*, 5(4), 327-335. doi: 10.1108/EUM00000000006797
- Koráb, V., & Murinová, A. (2017). Family Business: Experience from the Czech Republic. In L. Mura (Ed.), *Entrepreneurship - Development Tendencies and Empirical Approach*, IntechOpen. Rijeka, Croatia: InTech. doi: 10.5772/intechopen.71020
- Lušňáková, Z., Juríčková, Z., Šajbidorová, M., & Lenčesová, S., (2019). Succession as a sustainability factor of family business in Slovakia. *Equilibrium: Quarterly Journal of Economics and Economic Policy*, 14(3), 503-520. doi: 10.24136/eq.2019.024
- Odehnalová, P., & Pirožek, P. (2015). Family Businesses in the Corporate Governance of MNCs. *Acta Universitatis Agriculturae et Silviculturae Mendelianae Brunensis*, 63(3), 979-984. doi: 10.11118/ACTAUN201563030979
- Papula, J. et al. (2015). *Podnikanie a podnikateľské myslenie I*. Praha: Wolters Kluwer.
- Papula, J. et al. (2018). *Jako začať a úspešne podnikateľ*. Praha: Wolters Kluwer.
- Slovak Business Agency (2018). *Štúdiá rodinného podnikania na Slovensku*. Retrieved from sbagency.sk/sites/default/files/3\_studia\_rodinneho\_podnikania\_na\_slovensku.pdf
- Solíková, V. (2013). Small and medium sized enterprises (SMEs) and transfer pricing. *Acta Universitatis Agriculturae et Silviculturae Mendelianae Brunensis*. 60(2), 349-356. doi: 10.11118/actaun201260020349

## Contact information

### **Mgr. Jarmila Mižičková**

University of Prešov in Prešov, Faculty of Management  
Konštantínova ul. 16, 08001, Prešov, Slovak Republic  
E-mail: j.mizickovamail.com  
ORCID: 0000-0002-8392-3016

### **Ing. Michal Levický, PhD.**

Constantine the Philosopher University in Nitra, Faculty of Natural Sciences  
Tr. A. Hlinku 1, 94974, Nitra, Slovak Republic  
E-mail: mlevicky@gmail.com  
ORCID: 0000-0002-5297-1664

doi: 10.7441/dokbat.2019.074

# CONCEPTUAL MODEL TO ANALYZE THE INFLUENCE OF CUSTOMER PARTICIPATION AND VALUE CO-CREATION IN SOCIAL MEDIA ON BRAND PERFORMANCE

*Taha Nejad Falatouri Moghaddam*

## **Abstract**

Brand performance is shown how much a business is successful in the market for profitability and desirability, Value propositions is critical element influencing the brand performance, value proposition can be affected by different aspects of customer experience. In this research, we propose a conceptual model for analysing the level of Customer Participation in social media and value proposition co-creation and the effect of value propositions on brand performance. Social media provides an interactive area for the consumer and business owner to be in touch and to co-create value propositions. Considering this atmosphere, we have offered a conceptual model including Symbolic, Functional, Relational, Emotional, Entitativity and Economical values as possible values which can co-create by the users and business owners on social media. The effect of these values on performance of a brand has been examined as another point. Getting deep into the research literature we faced a new challenge that the behaviour of the different Generation is far from each other then we tried to participate in modern area then we included the generation differentiation into our research by focusing on Z generation as a mediator variable and other generation on the level of participation on social media for creating value propositions.

*Keywords: social media, customer participation, value proposition*

## **1 INTRODUCTION**

The profitability of a business could be prognosticated by its brand performance and the brand performance is in direct relation with the competitive advantage which is contributed to the level of value propositions and customer satisfaction of the service (Rintamäki, Kuusela & Mitronen, 2007). To creating such values companies can utilize different methods and strategies like product differentiation, agile supply chain, and modern marketing. One of most recent ways is involving customer in creating values through Customer participation for co-creating values. This could be more effective by utilizing new technologies such as social media. This methods and strategies could improve the value proposition while there is controversial question among the scholars how can that these effort improve the values and what trait of value proposition could be influenced by them. To address this question we characterize the values proposition in six different values, by emphasizing on social media activities as the driver of co-creating value proposition we try to understand the level of significance of customer participation on each type of values proposition.

New technologies changed almost in day to day lifestyle, we consecutively face new generation of movements that influenced by technology including retail industries, Retail 4.0 is one the mentioned revolutionary by-products of technology which it is introduced by McKensian company (Desai, Potia & Salsberg, 2012) according to their definition, Retail 1.0 was related to the time that modern supermarket has been emerged, which was the start of the 20th century. Retail 2.0 was done by the introduction of “everything under one roof,” this motto has been advertised by Carefor in 1967. The next step was retail 3.0. The final generation of retail is retail 4.0, the combination of all previous generations. Omnichannel selling or multi-channel



retail are integral parts of Retail 4.0. This evolution could be described from brick and mortar to click and mortar.

Social Media (SM) is a principal channel that is used in retail 4.0. In 2013 one fourth of world population attended in social media (1.7 billion) (Davis, Piven & Breazeale, 2014) and nowadays this portion has been raised to over 42% (Newberry, 2019). Besides, near 20% of people use social media as a source of news globally (Asher, Caylor & Neigel, 2018). Along this, SM could radically develop the ability of users to search and surf the internet for analysis and comparison of different services or products (Wang et al., 2019). Moreover, social media create an interactive for the customer and the provider of service to be in touch. These cooperative area has transformed the traditional consumer behaviour and relations, and create higher brand access which develops the strategies of branding under new engagement platform (Davis, Piven & Breazeale, 2014). Customer participation (CP) as one of the elements of social media has become more and more appealing, where the customer can generate their own content and share it as microblog, comment or any other customer-generated content (CGC).

Industries can use this atmosphere to improve their marketing efforts with lower expenditure, SM makes customer reachable and influence the processes of customer acquisition and retention (Carlson et al., 2018). Previous research has confirmed CP in SM could create different values for the companies brand (Asher, Caylor & Neigel, 2018), for instance customer could cooperate for Generating new Idea and broadcast it in social media network. This makes a co-creative atmosphere for both customer and business to escalate the brand perception, high level of communication among customers, social networks and retail brand could create astonishing outcomes. Describing customer values is not easy and we cannot find universal definition for it.

In this research we are going to propose a model to analyse how CP can affect the value proposition and the effect of customer values on brand performance. According to our model the customer participation can change the different type of value proposition while in previous studies many researcher tried to investigate the customer the relation between customer behaviour and value proposition in this research we decide to proceed the customer participation in social media as the critical element factor for creating value proposition.

## **2 CONCEPTUAL DEVELOPMENT**

Our theoretical model as described in Figure 1 illustrates the relation among customer values, customer participation and brand performance. In this model we are going to identify the effect of Customer participation on value proposition of customer in Symbolic, Functional, Relational, Emotional, Entitativity and Economical values. In consequence, we want to extract the effect of these values on Brand performance. To analyse the brand performance status we have to consider generation type to justify the generation role on customer participation and its effects.

### **2.1 CP in Social media**

The value propositions are not consuming by the consumption of products, they are experienced through a process of purchasing and consuming. The creation of value is an individual experience which is happening along a series of activities such as building relationships, active communication and knowledge gathering. In the retail industry the whole procedure is more in-depth while the customer gain these values in the “life world”. It means each step of the customer experience from purchasing to using and sharing the feedbacks shapes their values propositions of product or service (Carlson et al., 2019).

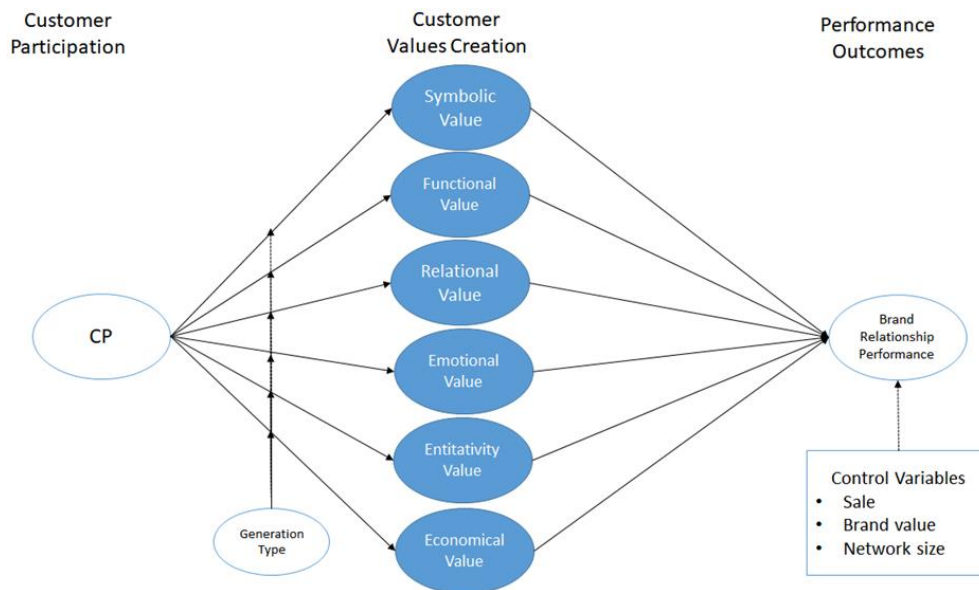

Fig. 1 – Conceptual Development Model. Source: own research

Finally the level of inter personal attraction of social media pages which can make a substantial foundation for connecting the current and optional customer this variable is under control of both individuals and companies. And both groups can help take part in it. Symbolic value is the self-expressive of customer consumption (Word of mouth) (Suryadi et al., 2018). Functional benefits is coming from higher quality that has been expected by the customer. Emotional value is related to the fun and enjoyment part of customer experience. Relational value is the benefit of meaningful relationship between customer and the service provider. Entitativity value is associated with the sense of belonging to a brand (Carlson et al., 2019) and finally the economic value is related to the price. In SM all these values could be analysed during the degree of interactivity and participating in such area (Carlson et al., 2019).

According to what is mentioned in the introduction part our proposed model is analysing the level of customer participation in social media and it impacts on value propositions. In order to find out the level customer participation in social media we extract different variable from the literature and clustered them into three groups first group of variable are personal variable this group of variable are under control by the individuals or customer who are attending in the social media page of companies: “time” amount of time allocating on activities is a good measure for showing the level of participation “Sharing” idea, posts, mini-blog and hashtags is another measure that can be counted as an active participation another essential variable is “personal characteristic” while many attendance of social media are not sharing their own characteristic and level of disclosure could show the loyalty, many people attend on social media to waste their time or as a personal habit but “helping” other customer and measure as a valid participation. The second group of variable are under control by the company and they are relating to the level of entertaining of the social media page from the point of users it is worth to mention that this variable can radically improves the number of attendance of the social media page.

### 3 HYPOTHESES DEVELOPMENT

**Effect of CP on Symbolic values:** Participating in social media can be obviously related to symbolic values where the customer can broadcast their purchasing and commitment to the brand on SM.

*H1: Higher level of CP could lead to more symbolic values*

**Effect of CP on Functional values:** According to (Davis, Piven & Breazeale, 2014) the customers usually attend in Social media of a brand for 1-solving some problems 2- sending inquiries 3- searching for brand information 4-analysing offers before purchase 5- to find out the brand's exclusive deals. Moreover, customers in social media can provide information and contact with the developers of the service to gain more functionality values across the production offers or feedbacks.

*H2: Higher level of CP could lead to more functional value*

**Effect of CP on relational values:** SM could connect the providers and the consumer without boundaries of location, individuals can have a customized relation to the brand owner and feel the sense of engagement in the brand strategies.

*H3: Higher level of CP could lead to more relational value*

**Effect of CP on emotional values:** Participating in brand strategies and development of product could increase the enjoyment relating to service and final outcomes. SM can quickly provide these interactive areas for both sides.

*H4: Higher level of CP could lead to more emotional values*

**Effect of CP on entitativity values:** This value is describing in the situation where all people are considered as one individual. In this case people share their idea not only for their own goals but also for the benefit of others. SM can provide this area in different ways from sharing their personal experiences to help others.

*H5: Higher level of CP could lead to more entitativity values*

**Effect of CP on economical values:** As it is mentioned in the introduction part of this article, people use SM to find out the best quality and best price for their needs. In other words, one of the main reasons for participating in SM is Economical value.

*H6: Higher level of CP could lead to more economical values*

### **3.1 The moderating role of generation on CP**

According to X, Y and Z generation (Betz, 2019) the generation X is better educated than their previous generations and more concerned in ethics and they are less engaging in technological affair. Generation Y as it is most well-known with the name Millennial Generation, faced with technology in their youngster age compared to their previous generation. They are not technology immigrants, they grow up with technology and near 80% of this generation are using smartphone, Y generation are calling digital natives. Finally Generation Z is the multitasking generation where they use technology while doing other activities simultaneously, this generation learn actively and has grown up in the internet world and their understandings of information system is different from their ancestors. Relating to these differences the generation attitudes towards CP is different and may be varied radically. To analyse these differences, we provide different hypothesis for the Z Generation where we guess they have a better understanding of CP and SM in many aspects to analyse the impacts.

*H7a: The relationship between CP and Symbolic value is stronger in Z generation*

*H7b: The relationship between CP and Functional value is stronger in Z generation*

*H7c: The relationship between CP and Relational value is stronger in Z generation*

*H7d: The relationship between CP and Emotional value is stronger in Z generation*

*H7e: The relationship between CP and Entitativity value is stronger in Z generation*

*H7f: The relationship between CP and Economical value is stronger in Z generation*

**Control variables:** To test our hypothesis in robust framework we used three control variables: sale, Brand value and network size to be sure that the results are not due to covariance with other variables.

## 4 MEASURING ITEMS

In order to analyse the idea we have to assess the sample opinion in the following items which comes in Table 1.

Tab. 1 – The measurement items of the concept. Source: own research

First-order constructs	Measurement items
Customer Participation	I spent a lot of time in my favorite brand social media
	I always express my need on my favorite brand social media
	I share my personal character on my favorite brand social media
	I have active participation in my favorite brand social media
	I always share my idea on my favorite brand social media
	I always help other people to find out information about my favorite brand on social media
	I always share my feedback on my favorite brand social media
	I always share suggestions to improve my favorite brand social media page
Symbolic value	I always share my new purchases of my favorite brand on social media
Functional Value	My favorite brand social media is helpful for me
	My favorite brand social media is useful for me
	My favorite brand social media is functional for me
Emotional Value	My favorite brand social media is funny
	My favorite brand social media is exciting
	My favorite brand social media is entertaining
Relational Value	My participation in social media of my favorite brand could help me make a better connection with other people
	My participation in social media of my favorite brand could make long term connection with my favorite brand
Entitativity Value	I feel like a family member in my favorite brand social media member
	I feel like a member of the organization of my favorite brand when I am participating in their social media
	I am satisfied with social media of my favorite brand
Economical value	I am supporting the pricing strategies of my favorite brand on social media

## 5 CONCLUSION

In this research we have proposed a conceptual model to analyse the effect of customer participation in social media on value proposition. We have extracted the relations among the variables through personal, companies and cooperative values by considering the impact of moderating variable of generation. We expect that the best method for analysing the idea in this methodology would be structural equation and the means for data gathering would be questionnaire among the attendance of public page of social media of prestige brand that is planned to be done in the future research participation in social media on value proposition. Presence of public page of social media of prestige brands that is designed to be done in the future research.

## References

- Asher, D. E., Caylor, J. P., & Neigel, A. R. (2018). Effects of Social Media Involvement, Context, and Data-Type on Opinion Formation. *2018 International Workshop on Social Sensing (SocialSens)*, 32-37. doi: 10.1109/socialsens.2018.00019
- Betz, C. L. (2019). Generations X, Y, and Z. *Journal of Pediatric Nursing*, 44, A7-A8. doi: 10.1016/j.pedn.2018.12.013
- Carlson, J., Rahman, M., Voola, R., & De Vries, N. (2018). Customer engagement behaviors in social media: Capturing innovation opportunities. *Journal of Services Marketing*, 32(1), 83-94. doi: 10.1108/JSM-02-2017-0059
- Carlson, J., Wyllie, J., Rahman, M. M., & Voola, R. (2019). Enhancing brand relationship performance through customer participation and value creation in social media brand communities. *Journal of Retailing and Consumer Services*, 50, 333-341. doi: 10.1016/j.jretconser.2018.07.008
- Davis, R., Piven, I., & Breazeale, M. (2014). Conceptualizing the brand in social media community: The five sources model. *Journal of Retailing and Consumer Services*, 21(4), 468-481. doi: 10.1016/j.jretconser.2014.03.006
- Desai, P., Potia, A., & Salsberg, B. (2012). *Retail 4.0: The future of retail grocery in a digital world*. Retrieved from <https://www.sipotra.it/wp-content/uploads/2017/06/The-future-of-retail-grocery-in-a-digital-world.pdf>
- Newberry, C. (2019). 130+ social media statistics that matter to marketers in 2019. Retrieved from <https://blog.hootsuite.com/social-media-statistics-for-social-media-managers/>
- Rintamäki, T., Kuusela, H., & Mitronen, L. (2007). Identifying competitive customer value propositions in retailing. *Managing Service Quality: An International Journal*, 17(6), 621-634. doi: 10.1108/09604520710834975
- Suryadi, N., Suryana, Y., Komaladewi, R., & Sari, D. (2018). Consumer, customer and perceived value: Past and present. *Academy of Strategic Management Journal*, 17(4), 1-9. Retrieved from <https://search.proquest.com/docview/2124080569?accountid=15518>
- Wang, Y., Chowdhury Ahmed, S., Deng, S., & Wang, H. (2019). Success of social media marketing efforts in retaining sustainable online consumers: An empirical analysis on the online fashion retail market. *Sustainability*, 11(13), 3596. doi: 10.3390/su11133596

## Contact information

### Taha Nejad Falatouri Moghaddam

Tomas Bata University in Zlín, Faculty of Management and Economics

Mostní 5139, 76001, Zlín, Czech Republic

E-mail: Falatouri\_moghaddam@utb.cz

ORCID: 0000-0001-9586-3180

doi: 10.7441/dokbat.2019.075

# APPLYING THE EXPECTED CREDIT LOSS MODEL UNDER IFRS 9 ON ISLAMIC SUKUK: EMPIRICAL EVIDENCE FROM JORDAN PUBLICLY TRADED COMPANIES

*Amer Morshed*

## **Abstract**

This paper explores the possibility of applying the expected credit loss model, which has been introduced by the IFRS 9, on Islamic Sukuk by the listed firms in Jordan. Employing the methodology of semi-structured interviews in the Arabic language with Ten Islamic accounting experts (Islamic accounting professors, Islamic banks financial managers and shariah scholars) from Jordan. This problem makes the Islamic Sukuk investment not tempting to Jordanian listed firms and that lead to reduce the firms' portfolio diversification and constrain the Sukuk market growing. Accordingly, obtaining solutions to the mentioned problem will increase the willingness to invest in Islamic Sukuk and advance its market in Jordan. The article concluded that the listed firms in Jordan can apply the expected credit loss model on Sukuk investment, and that supports the Malaysian argument about the discount rates used in the impairment. However, companies should use other prevailed factor than the interest rate if available to apply the Impairment. Additionally; the expected credit loss model is applicable only on the debt-based Sukuk since they are non-tradeable under Islamic finance rules and they are measured by amortized cost method as conventional bonds.

*Keywords:* Islamic Sukuk, IFRS 9, Expected credit loss model, AAOIFI, Investment market, Jordan

## **1 INTRODUCTION**

Islamic finance has arisen as an alternative and supportive financial mechanism in the financial market (Bakar et al., 2015). This tool relays on avoiding interest (usury) and using real underlying assets to complete the whole economic cycle. Since the Islamic finance began as a primary financial model, it was obligated to work in the dual banking system which is still being ruled by the conventional central banks. Following approximately a decade these banks started implementing independent products based on Shariah rules called "Sharia's based products." For example, Mudarabe'h deposits, (partnership investment deposits) and Ijara Motahiah be Altamlik (Islamic Financial leasing) (Cebeci, 2012). Therefore, Islamic financial organizations and committees attempted to issue a financial instrument based on Sharia's rules and align its work with the traditional bonds, in the direction of promoting the Islamic financial market, and facilitating the Islamic banking sector. These efforts reached out issuing investment tools called Sukuk as certificates of equivalent value. These certificates are representing undivided shares in ownership of assets, usufruct, and services, and it can be a possession of the assets of particular projects or specific investment venture, after receiving the value of the Sukuk, the closing of subscription and the employment of funds received for the purpose for which the Sukuk were issued (AAIOFI, 2015). Accordingly, during the year 2000 Sudan issued the first Islamic financial instrument called Sukuk, and within the year 2014 England issued Islamic Sukuk by GBP 200 billion as a first non-Islamic country issued Sukuk (Bakar et al., 2015). Recently, the global Sukuk market has been developing substantially. The value of international Sukuk released in 2014 was US\$114 billion (Biancone & Shakhathreh, 2016), and in 2017 it was US\$180 billion (Lahsasna, Hassan, & Ahmad, 2018). Concerning the progress in the Sukuk

market, the Accounting and Auditing Organization for Islamic Financial Institutions (AAOIFI) has issued the Islamic accounting standard number 25 "Investment in Sukuk, shares and similar instruments" in 2010 (AAOIFI, 2015). On the other hand, The International Accounting Standards Board (IASB) has adapted the IAS 39 to cover the conventional financial instrument (Gomaa, Kanagaretnam, Mestelman, & Shehata, 2018) then they replaced the IAS 39 with the IFRS 9 in 2018 and introduced the expected credit loss model (Mohamad & Hamed, 2017) as a unified model to run the impairment of all financial assets, which that advance the financial reporting (Gornjak, 2017). Concerning the existence of two accounting standards that rule the financial instruments in Jordan, because the listed firms apply the IFRS's and the Islamic banks apply the AAOIFI accounting standards, the listed firms are worried about investing in Islamic Sukuk for the reason of the conflict in accounting treatment and they need to be IFRS's complied. This article aims to investigate the eligibility of applying the expected credit loss model on Islamic Sukuk in the purpose of unifying the accounting treatment of the financial instruments "bonds "and "Sukuk" in that Jordanian firms and be fully complied to IFRS's.

The article reached out that the listed firms in Jordan can apply expected credit loss model on Sukuk investment with minor limitations, this result will provide positive effects on the Sukuk market and the firms 'portfolios diversification. The structure of the paper is as follows.

The first section provides a review of the literature concerning the Sukuk and the expected credit loss model explanation. This is followed by a discussion about analysis of the ability to apply this model with Sukuk. The next section describes the research method adopted for this research, followed by the findings from interviews, Discussion and Implication. Finally, the last section draws conclusions of the study.

## **2 LITERATURE REVIEW**

The AAOIFI define Sukuk as certificates of equivalent value. These certificates are representing undivided shares in ownership of assets, usufruct, and services, and it can be a possession of the assets of particular projects or specific investment venture, after receiving the value of the Sukuk, the closing of subscription and the employment of funds received for the purpose for which the Sukuk were issued (AAOIFI, 2015). Biancone & Shakhathreh (2016) described Sukuk as a phrase to explain financial instruments intended to comply with the principles of Islamic law. Godlewski, Turk-Ariss, & Weill (2013) said many Sukuk structures are designed to replicate the economic function of conventional bonds, while the bond is defined as debt security issued to finance any activities and whose value related to the creditworthiness of its issuer. These definitions clearly distinguish Sukuk from the bond in both theory and structure.

There are many types of Sukuk, and the article classifies these types into two categories. The first category is depending on the issuing structure (Siswantoro, 2016). There are two issues structures which are as follow: The "assets based Sukuk," after releasing the Sukuk the underlying asset was used in this process has to be on the statement of financial position of the originator. Therefore, originator still has its legal ownership of the underlying assets and the transferees the usufruct of the asset to Sukuk holders, and they have the recourse to the originator/obligor and cannot sale the Sukuk to the third party. This process is considered a non-true sale (Dusuki, 2009). The asset-backed Sukuk is a real transfer of legal ownership of the underlying asset from the originator to a third party. This process is done by the Special Purpose Vehicle (SPV). The SPV is in a position of explicit trustee of the Sukuk holders, and it receives fees as the issuer of the Sukuk. Consequently, the Sukuk holders become the legal part-owners of the underlying asset that receive a return on investment based on the performance of the underlying asset, and they have no recourse to the originator (Abdullah,

2012). Hidayat, (2013) conducted a comparative analysis between asset-based and asset-backed Sukuk structures from shariah viewpoint and obtained that even the asset-based Sukuk structure is still principal in the market the asset-backed Sukuk structure is more compliant to Shariah.

The second division is depending on the contractual relationship between the issuer and the investors. There are two contractual relationships to issue the Sukuk which are as follow: The debt-based Sukuk, that depend on debt contacts like Murabaha, Istsnaa and any contract which is complied with the Islamic rules can issue debt; additionally, the revenue of the investors is depended on the credit risk of the issuer, and this Sukuk are not tradeable(Wilson, 2008). The equity-based Sukuk that based on partnership contracts like Mudarab, Musharaka, and Istithmar .and the investors participate in contributing equity to invest in the Sukuk assets, and their revenue is depending on the performance of the assets (Bakar et al., 2015).

During 2014 IASB declared adopted draft of IFRS 9 to replace the current standard IAS 39, and the IFRS 9 will have been obligatory by the end of 2018 (Gornjak, 2017). The IASB justifies that replacement of IAS 39; that IAS 39 adapt the rules methodology that will make the decision more constant and predictable, yet rules methodology does not support to perform a productive accounting treatment. On the other hand, IFRS 9 depend on principles methodology. The problem with this methodology is these no operational assistance (Benston, Bromwich, & Wagenhofer, 2006).

Gornjak (2017) mentioned that the expected credit loss as a unified model to run the impairment of all financial assets, which that advance the financial reporting. Impairment of the financial assets produces tangible changes in accounting policies, which adapts the model of future losses, although stakeholders have a vision into an instrument with increase the credit risk. Novotny-Farkas (2016) said the recent recognition of credit losses would diminish the accumulated of loss continuations and the overemphasis of regulatory capital. Furthermore, protracted disclosure requirements are possible to contribute to more effective market discipline. Through these channels, IFRS 9 improve financial stability. Gomaa et al. (2018) realised, that the FASB requires the current judgment of all cash flows not assumed to be settled by an entity that includes the all financial instruments at each reporting date. That provision settles adequate for the meeting of the entire proposed credit losses, plus that will display the economics of lending and loan losses through approving that economic losses occur if credit-loss expectations change from initial expectations. However, among other things, it remains challenging to predict the result of the combination of the FASB's imperative that the provision for credit losses should consider the full amount not supposed to be settled on financial assets. Bushman said the expected credit model would enhance the bank transparency considering it presents a part in mitigating or heightening such credit risk interests.

IFRS's reports the general model for impairment based on fluctuations in credit quality since initial recognition in three steps:

The first Stage involves financial instruments that do not have a meaningful increase in credit risk after the initial recognition, or that has low credit risk at the reporting date. For these assets, twelve -months expected credit losses are recognised, and interest revenue is calculated on the gross carrying amount of the asset; considering that is, without deduction for credit allowance. Twelve -months are the expected credit losses that result from default events that are apparently within twelve -months after the reporting date. It is not the predicted cash shortfalls over the 12 months but the entire credit loss on an asset-weighted by the probability that the loss will happen in the following twelve -months.

The second Step involves financial instruments that have a significant increase in credit risk after the initial recognition, but there is no actual indication of an impairment unless they have low credit risk at the reporting date. Accordingly; the lifetime of expected credit losses of these



assets are recognized, and the calculation of the interest will be on the gross carrying amount of the asset. The period of anticipated credit losses are the expected credit losses that occur from all possible default cases of the whole assumed life of the financial instrument. Expected credit losses are the weighted average credit losses with the probability of default as the weight. The third Stage includes financial assets that have objective evidence of impairment at the reporting date. For these assets, the entity recognises the lifetime of expected credit losses, and interest revenue is calculated on the net carrying amount (IFRS 9 Financial Instruments).

### **Analysing the eligibility of applying the expected credit loss model on the Sukuk**

Abdullah (2012) mentioned that Islamic financial institutions had been established with different Objectives and principles and they have different financial products with the conventional financial institution. Consequently, when applying the IFRS's, that will encounter unique functions of Islamic Financial products, and it includes Sukuk. The application of the expected credit loss model using discount rates with the Sukuk. According to Islamic finance rules interest is prohibited. (Siswantoro, 2016) mentioned, rather than a market interest rate, other rates are considered as rental or leasing (Ijarah) rate using the debt-based structure or a profit-sharing (Mudaraba) using the equity-based structure. Moreover, Suandi (2016) said, Malaysia adapts the impairment based on discount rates The Malaysian argument is that discount rates used in the Impairment are only for calculation, and it is not for crediting interest to a debtor, which is explicitly forbidden. Accordingly, the Malaysian Accounting Standard Board (MASB) admits the IFRS's methods of valuation then they MASB replaced the current Islamic accounting standards with IFRS standards. Accordingly, questions arise: (1) Could the listed firms in Jordan apply the expected credit loss model with the Islamic Sukuk?, and (2) If they can, are there limitations on the application?

## **3 STUDY PROBLEM AND VALUE**

According to the literature review, the listed firms in Jordan face accounting problem about investing in Islamic Sukuk. This problem related applying the expected credit loss model under IFRS 9 since these firms are obligated to be IFRS's complied and the Sukuk have different features than the conventional investment tools. This problem makes the Islamic Sukuk investment not tempting to Jordanian listed firms. Accordingly, analysing the eligibility of IFRS 9 to govern the Sukuk and providing solutions to the mentioned problem will increase the willingness to invest in Islamic Sukuk and advance its market in Jordan and lead to develop the Sukuk market and the firms' portfolios' diversification.

## **4 METHODOLOGY**

The article used semi-structured interviews in the Arabic language with Islamic finance experts. These semi-structured interviews were carried within a reasonably open connection; hence, the questions asked were not necessarily prepared in advance. Many of the questions were automatically generated during the interview, which gave flexibility to both the interviewer and the participant to explore and discuss additional details.

In opposition to structured interviews, where all questions are organized and compiled ahead of time, the interviews were in the form of a conversation rather than a question and answer method. Additionally, the relationship between the researcher and the participant is not rigidly formulated.

The researcher will have a mental framework of study questions, and his success will depend on his professional experience and qualifications in Islamic finance and accounting (Cassell, 2015). Specifically, questions posed to any participant will differ according to the context and

setting of the interview. The qualitative researcher should not adapt to any uniform behaviour for an interview. Preferably, the qualitative interview is shaped in a conversational mode, and the conversation itself will lead to a sort of social relationship, where the quality of this relationship is unique to every participant (Cassell, 2015).

#### 4.1 Sampling

Ten Islamic accounting experts (Islamic accounting professors, Islamic banks financial managers and shariah scholars).

Tab. 1 – Islamic accounting experts. Source: own research

Description	Qualifications
Islamic finance researcher, lecturer, and Islamic accounting expert	Fully professor in Islamic banking
Islamic finance researcher and lecturer and a member of Sukuk issuing agency	Associated professor in Islamic finance
Islamic finance researcher and lecturer	Associated professor in Islamic finance
Islamic finance researcher and lecturer	Associated professor in Islamic finance
An assistant general manager at Islamic financial institution	PhD in Islamic banking, JCPA, and CIPA
Financial manager at Islamic financial institution	CIPA
Assistant Financial Manager at Islamic financial institution	Master's in finance
Senior Accountant at Islamic financial institution	CPA and CIPA
Shariah scholar	PhD in Islamic commercial law
Shraea'h scholar, shariah internal control manager at Islamic financial institution	PhD in Islamic jurisdiction

## 5 FINDINGS, INTERVIEWS ANALYSIS

The question was started with Islamic accounting professors. Is there any availability to apply the expected credit loss model that is included in IFRS 9, on the Sukuk? The researcher explained the concept to the participants as a recognition of a loss provision against the future cash inflow from a loan of a bond, based on the company policies and the market interest rate (Siswantoro, 2016).

The professors mentioned the importance of the expected credit loss model " for Islamic banks it is important to expect the loss provision for more effective risk hedging and it saves the stockholders interest" that means the listed firms have to apply this model for the reason of risk hedging and IFRS's compliance. however, the participates agreed to apply this model since they cited "there is no problem since Islamic banks use the interest rate to determine the Murabaha mark-up and it is for risk hedging not for charge interest". During the conversation, they added, "it will be better if the company use another factor than the interest rate". To emphasize the Islamic rules part, the researcher repeated the same question to the Shariah scholars with a clear and detailed clarification of the expected credit loss model. The Shariah scholars are agreed about applying this model "I do not see any problem" and "since it was applied to save the investors interest, I agree". The realization of this discussion; the companies can apply the expected credit loss model on the Sukuk, yet using other rates than interest is preferable. Moreover, that implicitly agree with the Malaysian argument that discount rates used in the Impairment are only for calculation, and it is not for charging interest to a debtor, which is explicitly prohibited (Suandi, 2016).

The question was repeated to Islamic banks financial managers in the purpose of realizing their real practice. The financial managers supported what was mentioned in literature review "we are working under a conventional banking system " and this situation make following the central bank rules by all bank in Jordan obligatory (IFRS 9- central Jordan) . The central bank rules are to apply IFRS 9 in the Sukuk.

However, they do not make any objection to apply it "there is no problem with the provision possession since it will be amended if there are any positive indicators". They added an important note for the accounting treatment" debt-based Sukuk are not tradable and have to be only under amortised cost, so we have to apply the ECLM". This discussion approves the last realization and removes any accounting conflict. Additionally; by looking to the outcomes of the first question, extracting accounting treatment which is, only the debt-based Sukuk classified under financial assets since they are non-tradeable under Islamic finance rules (Bakar et al.2015) and they are measured by amortized cost method as conventional bonds. Accordingly, the expected loss model applies only to debt-based Sukuk.

## **6 DISCUSSION AND IMPLICATION**

The paper has recognised the development of Islamic finance and the issuing of the Sukuk over the years and found that the stance on reporting the Sukuk under the AAI OFI accounting standards and the IFRS's and discloses that the listed firms in Jordan are aware of the application of the ECLM that mentioned in the IFRS9 on Islamic Sukuk investment since they are governed by the AAOIFI accounting standards, where the standards are being used in preparing these firms financial statements are the IFRS's; that could make these firms are not fully IFRS's complied. This issue reduces the willingness of these firms to invest in Sukuk; therefore, constrain the improvement of Sukuk market and the portfolio diversification.

Interestingly, the evidence shows that the interviewees placed a higher emphasis on the availability and the value of reporting the Sukuk under the IFRS's and application the expected credit loss model under IFRS9 on the Islamic finance industry while they provide a non-conservative opinion to Sharia's issues.

The findings show the application of ECLM on Islamic Sukuk is well recommended by the interviewees, they agreed that the application does not mistake the Islamic part of the Sukuk and it is important to the accounting information quality and risk hedging. They justify the using of the interest rate for the reason of that usage is only for risk appraisal and not for gaining interest profit, which is prohibited by Islamic law. Additionally, they mentioned that Islamic finance is still working under the traditional banking system and these Sukuk are a replacement to the bonds and there are common features between Sukuk and bonds.

The practical implications of the study. Firstly, the evidence from the interviews implies how the application should be, which mentioned the priority to use another prevailed discount rate than the interest if available. Secondly, the results provide a radical accounting treatment, which is only the debt-based Sukuk classified under financial assets since they are non-tradeable under Islamic finance rules (Bakar et al.2015) and they are measured by amortized cost method as conventional bonds. Accordingly, the expected loss model applies only to debt-based Sukuk. This finding will provide a useful guide to how the firms will apply the ECLM on Sukuk and be fully IFRS's complied.

## **7 CONCLUSION**

Since the year 2000 when Sudan issued the first Islamic financial instrument called Sukuk, the Islamic finance industry desires to advance the Sukuk market, since this Sukuk are the only investment tool that could replace the function of traditional bonds and simultaneously an Islamic rules product complied. Therefore, the AAI OFI issued an accounting standard to provide an accounting guide for the firms they have the desire to invest in Sukuk. The dilemma has arisen since the firms, which are interesting in Sukuk investment, are reporting their financial statements with IFRS's. Accordingly, the willingness of the firm globally is reduced

since they are aware from the accounting conflict and need to be IFRS's complied, so they are imposed to use the IFRS's only. Emphasizing on the IFRS9 the radial issue is related to the ECLM application on the Sukuk. The question of can I as a financial manager apply the ECLM under the IFRS9 on Sukuk to invest is Sukuk and be Islamic law and IFRS's complied?

The article studied the Jordanian market since the listed firms aware of both IFRS's and Islamic law, using the semi-structured interviews with Jordanian accounting and Islamic law experts.

Following the interviews' interpretation and analysing, this article obtained that: The listed firms in Jordan can apply Expected credit loss model on Sukuk investment, that support the Malaysian argument that discount rates used in the Impairment are only for calculation, and it is not for charging interest to a debtor, which is explicitly prohibited (Suandi, 2016). Yet it should be Using other prevailed factor than the interest rate if available when applying the expected credit loss model and Only the debt-based Sukuk classified under financial assets since they are non-tradeable under Islamic finance rules (Bakar et al.2015) and they are measured by amortized cost method as conventional bonds. Accordingly, the expected loss model applies only to debt-based Sukuk.

Qualitative research is worth exploring this issue. This study adds to the current body of knowledge by contributing to answering the dilemma of the need of applying the ECLM under IFRS on the Sukuk by listed firms in Jordan. In future, it is hoped that IFRS's will consider Shariah features of the Sukuk in substance. This development will help to fulfil the desire of Islamic finance to improve the global Islamic financial market as a whole and provide other investment and funding tools to the market.

## References

- AAOIFI. (2015). *AAOIFI's Shari'ah Standards*. Manama, Bahrain: Accounting and Auditing Organization for Islamic Financial Institutions.
- AAOIFI. (2015). *AAOIFI's Accounting, auditing and governance standards*. Manama, Bahrain: Accounting and Auditing Organization for Islamic Financial Institutions.
- Abdullah, A. K. (2012). *Asset-backed vs asset-based Sukuk*. Kuala Lumpur, Malaysia: International Institute of Advanced Islamic Studies.
- Benston, G. J., Bromwich, M., & Wagenhofer, A. (2006). Principles-versus rules-based accounting standards: The FASB's standard setting strategy. *Abacus*, 42(2), 165-188. doi: 10.1111/j.1468-4497.2006.00196.x
- Biancone, P. & Shakhathreh, M. Z. (2016). Accounting Issues in Sukuk Issuance. *International Journal of Islamic Economics and Finance Studies*, 2(3), 95-108. doi: 10.12816/0036631
- Cassell, C. (2015). *Conducting research interviews for business and management students*. New Delhi, India: Sage.
- Cebeci, I. (2012). Integrating the social maslaha into Islamic finance. *Accounting Research Journal*, 25(3), 166-184. doi: 10.1108/10309611211290158
- Baker, R. (2015). *CIMA Advanced Diploma in Islamic Finance*. London, UK: Chartered Institute Management Accountant.
- Dusuki, A. W. (2009). *Shariah issues on asset based Sukuk*. Manama, Bahrain: Accounting and Auditing Organisation for Islamic Financial Institution.

- Gomaa, M., Kanagaretnam, K., Mestelman, S., & Shehata, M. (2018). Testing the Efficacy of Replacing the Incurred Credit Loss Model with the Expected Credit Loss Model. *European Accounting Review*, 28(2), 309-334. doi: 10.1080/09638180.2018.1449660
- Gornjak, M. (2017). Comparison of IAS 39 and IFRS 9: The Analysis of Replacement. *International Journal of Management, Knowledge and Learning*, 6(1), 115-130. Retrieved from [http://www.issbs.si/press/ISSN/2232-5697/6\\_115-130.pdf](http://www.issbs.si/press/ISSN/2232-5697/6_115-130.pdf)
- Hidayat, S. (2013). A Comparative Analysis between Asset Based and Asset Backed Sukuk: Which One is More Shariah Compliant? *International SAMANM Journal of Finance and Accounting*, 1(2), 24-31. Retrieved from <http://citeseerx.ist.psu.edu/viewdoc/download?doi=10.1.1.682.125&rep=rep1&type=pdf>
- IFRS 9 Financial Instruments. (n.d.). Retrieved from <https://www.ifrs.org/issued-standards/list-of-standards/ifrs-9-financial-instruments/>
- Lahsasna, A., Hassan, M. K., & Ahmad, R. (2018). *Forward Lease Sukuk in Islamic Capital Markets*. Cham, Switzerland: Palgrave Macmillan.
- Mohamad, S., & Hamed, M. (2017). Analytical study of the implications of the adoption of IFRS 9 on the credit and financing policies of Arab banks. *Arab Journal of Science and Research Publishing*, 1(9), 1-26. doi: 10.26389/AJSRP.2015-499
- Novotny-Farkas, Z. (2016). The interaction of the IFRS 9 expected loss approach with supervisory rules and implications for financial stability. *Accounting in Europe*, 13(2), 197-227. doi: 10.17449480.2016
- Shafii, Z., & Abdul Rahman, A. R. (2016). Issues on the application of IFRS9 and fair value measurement for Islamic financial instruments. *Journal of Islamic Accounting and Business Research*, 7(3), 202-214. doi: 10.1108/JIABR-03-2016-0031
- Siswantoro, D. (2016). The Influence of IFRS on the Sukuk Accounting Standard in Indonesia. *Singapore Middle East Insight Islamic Finance Special*, 1-13. doi: 10.23976/ifs.2016008
- Wilson, R. (2008). Innovation in the structuring of Islamic Sukuk securities. *Humanomics*, 24(3), 170-181. doi: 10.1108/08288660810899340

### Contact information

#### Amer Qasem Abdallah Morshed

University of Sopron, Alexandre Lamfalussy Faculty of Economics

Erzsébet st. 9, HU-9400 Sopron, Hungary

E-mail: Amer.Morshed@phd.uni-sopron.hu

ORCID: 0000-0002-9756-5854

doi: 10.7441/dokbat.2019.076

# INNOVATIVE APPROACH IN THE DUE DILIGENCE PROCESS

*Christoph Müller*

## **Abstract**

The article provides an overview of the current status of an ongoing research in the field of Mergers and Acquisitions (M&A) which focusses on Due Diligence (DD). The reasons for the research are the followings. On the one hand, the number of acquisitions is increasing and they become more and more important for an increasing number of companies. On the other hand, there is a big amount of failed M&As. Due to that, three of the main research questions are: (1) Why is it, that a company is not evaluated with the same parameters during the DD as it is controlled afterwards in the post-merger phase?; (2) Shouldn't the DD process be understood and assessed as an integrated system?; and (3) Would a closer link between Strategic Controlling and DD help to increase the success rate of M&As? The first part is a literature research, to define the theoretical framework. There are two main areas, the Strategic Controlling on the one hand and M&A on the other hand. The theoretical findings are specified through expert interviews. The expert interviews are semi-standardized. There is a quantitative and a qualitative part. Based on the analysis, a concept for a leaner DD approach is developed. The article presents the current status of the research and provides an outlook for the next steps.

*Keywords: Mergers and Acquisition, Due Diligence, Strategic Controlling, Integrated analysis, Synchronization of controlling in pre- and post-merger phase*

## **1 INTRODUCTION**

There are various approaches for company growth. Organic growth based on the gain or recovery of market share are possibilities as well as the development of new markets and the acquisition of competitors or complementary companies. Depending on time, market and company, the right approach needs to be chosen. In the past Mergers and Acquisitions (M&A) were more likely executed by multinational companies, nowadays the number of transactions of mid-size companies grows steadily (Koch & Wegmann, 2002). In addition to the above-mentioned background, there are still two specific approaches for smaller companies for a vertical or a horizontal expansion. On the one hand, the negotiating power with regard to customers and suppliers increases as a result of the increase in volumes. On the other hand, small and mid-size enterprises (SME) all around the globe facing the challenge of not having a successor for the company. According to statistical assessments only in Germany there will be a lack for up to 110,000 company follow ups over the next five years. (Hauser, Kay & Boerger, 2010). While big companies have easier access to resources to run M&A process, for example with an own department, SME mostly do not have M&A know how and resources available. But even big companies that seem to have the right resources, are not seldom in a state of economic problems after the takeover. Sometimes the whole transaction is being completely cancelled. The question is: What is the reason for that? And what could be done different to avoid the inefficiency?

## **2 RESEARCH METHODOLOGY**

Different research approaches were evaluated in preparation of this article. The most appropriate ones were finally chosen. The first part is of theoretical nature and was executed by analyzing the existing literature. The theories behind M&A and DD are evaluated as well as the

Controlling approach using the scorecard model. As part of the literature review an introduction of the most important terms can be found in chapter three of this article. Furthermore, empiric research is executed. Qualitative and quantitative methods were analyzed. The main goal was to get more detailed information about the theoretical findings. Finally, the method expert interview was chosen. The structure of the interviews is described in chapter four. Based on the theoretical background and the information gained out of the expert interviews the challenges and opportunities are analyzed. A summarized version is shown in chapter five. Based on the findings a new DD approach is defined on a conceptual basis. The concept will be introduced in chapter six. In the ongoing research a case study will be used as proof of the concept. The case study is part of the research, but not of the article.

### **3 THEORETICAL BACKGROUND**

First of all, the theoretical background needs to be described. The focus is on M&A and the DD on the one hand and the second part the strategic controlling. It follows a summarization of the definition in the following three sub-chapters.

#### **3.1 Mergers and Acquisitions**

Companies choose M&A, in particular in the same or related industries, when they want to strengthen their core business (Wirtz, 2003). On the other hand, companies are selling their non-core businesses. Both reflect the optimizing strategies of companies, which face increasing challenges (Coyle, 2000). This includes the acquisition of a competitive advantage. Especially when it comes to different technologies needed in different markets companies try to assure access to the relevant products to have the power over the quality and price of these products and related innovation (Bruner & Perella, 2004).

First of all, the decision of a company is made to participate in M&A transaction because a potential target, which was identified to be beneficial to its strategy. There are different approaches in literature, but the majority of it claims that a merger follows the three following phases: (1) Pre-merger phase; (2) Merger- or transaction phase; and (3) Post-merger phase.

The three phases are the main steps within M&A process and can therefore be broken done in sub-areas. Concepts with up to nine phases are existing (Jansen, 2016). Out of all different theories a common understanding is that an acquisition consists of screening, selection, evaluation, pricing, negotiation, DD, closing and integration (Gates & Very, 2003).

Screening, selection and evaluation can be interpreted as the pre-merger phase (Gates & Very, 2003; Jansen, 2016). This phase includes an analysis of the company followed by an analysis of the competition and the market. The evaluation of the motive for the merger delivers the definition for the strategies of the acquisition (Gates & Very, 2003; Jansen, 2016). The merger or transaction phase starts with contacting the possible target and to start negotiations followed by the DD and the closing. The DD process carefully analyzes to be acquired company on different sub areas, such as economic, legal, tax and financial circumstances (Jansen, 2016).

The post-merger phase includes a post-merger planning and ends with a post-merger audit which concludes the M&A process (Jansen, 2016). An additional topic, which needs to be included as well is the post-merger-integration (PMI) (Gates & Very, 2003). Usually there is no difference made between the M&A process of large-scale enterprises (LSEs) and SME. In other words, the process of M&A is the same, even the organizational structure and the available resources and the knowhow regarding M&A are significantly different. The following illustration visualizes the three main and nine sub areas of the M&A process in its consecutive order.

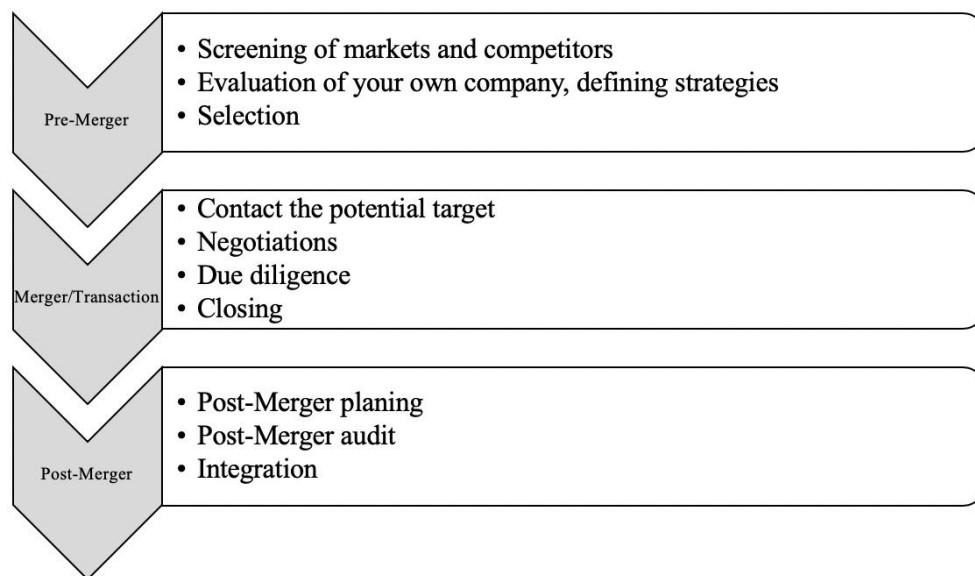

Fig. 1 – M&A process. Source: Jansen (2016), Gates & Very (2003)

Every single phase offers room for improvement and can be optimized. The focus of the research is on the DD area as the key for a successful M&A.

### 3.2 Due Diligence

There is not one overall valid definition of DD in the existing literature. It can be de-scribed as a detailed examination of a company, executed before becoming involved in a business arrangement with it, such as buying or selling its shares (Koch & Wegmann, 2002). It is the investigation with a reasonable standard of care (Koch & Wegmann, 2002). Further specified is the careful analysis and valuation of an object in a business transaction (English, 1994). Concept and wording were created and established in the United States of America as part of the security laws and is nowadays used, with the English expression all around the globe (Russ, 2018). In other words, DD is the basis for M&A. It is a thorough examination of another company (Stern, 1993).

The capacity of the company's internal assessment of the findings and the drawing of the correct conclusion are often limited due to a lack of time and experience. In big companies, whole departments are entrusted with the DD in the context of company acquisitions. SME often involve external partners to cover the missing experience and capacity (Koch & Wegmann, 2002). Although business transitions in the same country are already complex under the same legal conditions as well as under identical accounting rules, the complexity of the transitions in an international context is multiplied by a large number (Scott, 2001).

As a basis of the DD the company to be examined is split into different subdivisions. Each of it is carried out with separate checklists to ensure that the essential points at each level have been subjected, analyzed and audited. It does not primarily refer to the components and circumstance of the test but to the quality of the tested components (Howson, 2017). Initially, the main components were financial, tax, legal, commercial, organizational and technical DD. Due to developing markets and the differences between industries the number and the content of DD can be different (Krüger & Kalbfleisch, 1999). The reasons for a DD are diverse and range from the departure of a shareholder, on to the transformation of the company form. Other reasons can be the follow up with a turnaround of an enterprise after its recovery and the final sale of the company (Scott, 2001). The basic structure is further subdivided and adjusted depending on the reasons and the resulting focus of the audit. Depending on the scope of the



test, a distinction is made between full and partial DD. When buying a company, a fully comprehensive audit is performed, which also has a high level of detail (Scott, 2001). The main requirement is to recognize the opportunities and risks of a company purchase in advance and thereby to prepare the fundamental decision regarding a company purchase (Koch & Wegmann, 2002).

It is the goal to conduct a complete and consistent assessment of the target company. All factors on the buy-side are used. This is the so-called buy-side DD. The counterpart is the sell-side DD, in which a company is judged from the seller's point of view. The goal is to evaluate all transactions that are responsible for the success of a company with a 360-degree view of the company (Unzeitig & Kulhavy, 2009).

### **3.3 Strategic Controlling**

Behind company-wide, active controlling and active corporate management is much more than a cost control system. An integral part of company-wide integrated controlling is the commercial, technical, sales, market and environment-based controlling. Nowadays, controlling by means of detailed and constantly reviewed planning and simulations prevents wrong decisions and efficiency losses of all kinds. Companies gain access to transparent structures and procedures, from which improvement and cost-saving potentials as well as growth potentials can be identified. It is the crucial foundation for current and market-oriented corporate governance. In general, it helps to permanently improve results, to plan the success of individual departments in detail and to detect and eliminate weak points. Controlling and the associated business intelligence systems are a key factor in business success, regardless of size and global positioning. Kaplan and Norton understood the shortage and inefficiency of the classical Performance Measurement System (PMS) and created a model that had a more holistic view, which eliminated the problems of classical PMS. With the invention of the Balanced Scorecard (BSC), organizations focused on short- and long-term goals, monetary- and non-monetary indicators and perspectives of external and internal performances. (Fernandes, Raja & Whalley, 2006; Horváth, 2011).

“The BSC complements financial measures of past performance with measures of the drivers of future performance. The objectives and measures of the scorecard are derived from an organization’s vision and strategy.” (Kaplan & Norton, 1996).

The ultimate goal of the BSC was to translate strategy and vision of an organization into measurable objectives. Those objectives can be subdivided into four different perspectives: Financial, customer, internal-business-process and learning and growth. The expectations of the shareholders define the financial perspective. The customer perspective identifies how the organization wants to be seen by its customers. The internal-business-process perspective explains the business processes. The processes are important for the organization to satisfy the expectations of shareholders and customers. The learning and growth perspective shows the improvements and changes the organization needs to implement in order to translate vision into strategy. Kaplan and Norton encouraged managers to monitor Key Performance Indicators (KPI) of the four respective categories that picture a balanced view between short- and long-term goals, monetary- and non-monetary indicators, and a perspective of external and internal performance (Fernandes, Raja & Whalley, 2006). But all KPIs should be linked with financial goals, because if the employees are not satisfied with the new formed organization, their performance will not increase over time and hence the internal processes will not become leaner. Therefore, customer requirements cannot be processed in an appropriate time which can lead to unsatisfied customers. As a consequence, sales will drop, and this will impact the financial KPIs.

### **3.4 Findings and basis for further research**

The theories of Strategic Controlling and DD show similarities. Both try to cover a company as a whole. But at the end the approaches are executed in totally different structures and ways. There is a long history of DD and the theories existing in the literature, but as well a great number of failed company acquisitions. The assumption based on the literature research is, that what caused the failure of a M&A at the end, could have been discovered during the DD with a more integrated form of an evaluation, a consideration of sustainability and more future orientation. Those are the main differences between the Strategic Controlling and the DD. While Strategic Controlling tries to integrate the different areas in one concept to cover the company as a whole and to consider sustainability and future orientation, the well-known DD approaches are strongly oriented to the actual situation as well as the past. The sustainability and the future orientation of the company remain largely ignored. A concept for the systematic analysis of a company with the inclusion of company-internal as well as sector-specific parameters is only conditionally existent. There is no particular attention paid to the future viability of the company, which means that not only a static assessment of the actual situation is to be undertaken, but also an outlook on the company's sustainable success potential (Keuper, Häfner & von Glahn, 2006).

Besides that, the efficiency of the DD was discovered as a big challenge. By using the existing theories on average, a total of 112 man-days are added for a DD (Schneider, 2016). This is covering a lot of capacity within the company or external resources need to be used. During this period an in-depth examination and, in particular, an estimation of the future estimated performance of the company to be acquired is just impossible. While the internal resources are often limited in SMEs, as already mentioned above, the external resources are often not familiar with the details of the industry. To a large extent, problems arising as a result of an acquisition of the company are due to errors during the DD which have arisen because of time constraints. This does not only cause inefficiency and costs on the buy-side, but as well on the sell-side (Keuper, Häfner & von Glahn, 2006).

Based on the literature research the main findings which need to be further examined were the followings: (a) DD and Strategic Controlling are similar but executed without a direct connection; and (b) Inefficiency due to unclear structure, which causes a waste of resources (time, money) and trust of the target company.

In the further research expert interviews were set up to get a clearer picture on the fundamental question, if a closer link between DD and Strategic Controlling could help to increase efficiency and success rate of M&As.

## **4 EXPERT INTERVIEWS**

The expert interview is a special form of the semi-structured interview. The person interviewed is herein reduced to their expertise in the related topic. The status as an expert is related to the research topic and therefore represents a subjective view of the interviewer. Within the research the experts are either employees of the SMEs involved in the DD process or consultants working with SMEs in such kind of DD projects. As non-standardized or semi-structured interviews are a mixture of open and closed questions, the answers are formulated in their own words. Therefore, topics the interviewer did not think of, prior to the interview might be covered (Döring & Bortz, 2016).

The closed questions, do already offer predefined answers. The answers are based on the literature analysis. Besides that, the interviewees do always have the option to mention an additional point not covered in the predefined answers. The category is called others. If the

category is chosen, it needs to be specified. The open questions did not include any kind of predefined answers. The target is, to get more insights and a broader knowledge out of the experience of the experts. The answers are coded to define categories (Mayring, 2003).

The expert interviews were held in a semi-standardized way. There were some key questions and some eventual questions. The key questions were asked in every interview to keep the same structure. The eventual questions were only asked, in case a clarification was needed or in case the interview tended to leave the standardized direction (Sargeant, 2012). The following graph shows the questionnaire.

Questionnaire – Qualitative Research dissertation thesis
1. What are the main drivers for M&A?
2. Which phase within the M&A procedure is the most challenging one, out of your experience?
3. Which are the main reasons for a failing M&A project?
4. Which DD areas are you executing?
5. Why is this phase so challenging? / How would you describe the main difficulty of the DD?
6. What is based on your expertise, the best approach for the labor setup of the DD?
7. Why is this approach the most appropriate one?
8. What are the biggest challenges in setting up the right DD team?
9. In which area is it required to work with external consultants?
10. Could you please rank the importance of external consultants based on the DD areas you are executing (5 = very important, 1 = not important)?
11. In which area is the expertise of own employees important?
12. Could you please rank the importance of internal experts based on the DD areas you are executing (5 = very important, 1 = not important)?
13. Why is it so difficult to get access to the right data during the DD?
14. Out of your perspective is there a link between the different DD areas?
15. Are the different DD areas in the execution integrated in one approach?
16. What is your strategic controlling approach?
17. Out of your experience is there enough link between the companies strategic controlling approach and the areas considered in the DD?
18. Would a stronger connection help to increase the quality of the DD and the success of the M&A activities?
19. Out of your experience is there enough future orientation and enough focus on the sustainability of the target company?
20. How can the DD process be improved to be more efficient, without a decrease in quality?

Fig. 2 – Questionnaire. Source: own research

The questionnaire follows one guideline. The guideline was slightly adapted depending on the fact, if the interview was held with an employee of the SME or with a consultant. The interviews are analyzed in a combined way. There is a deductive approach as well as an inductive one. The deductive codes which are analyzed based on the parameters found in the literature research are the basis, which is enriched with inductive parameters found directly in the interviews.

Within the study ten experts were interviewed during a period of a month to provide further inside into the topic. The number was not predefined. The interviews were stopped, once the saturation point was reached and no additional information could be gained anymore. The basic requirements for all experts were, that they have at least five years of working experience in strategic controlling of a company or consulting and participated in M&A.

## 5 RESULTS OF THE QUANTITATIVE PART OF THE EXPERT INTERVIEWS

The question for drivers of M&A allowed multiple answers. As drivers for M&A activities 70% of the interviewed persons mentioned the situation that the potential target company misses a successor and therefore proactively searches an acquirer. All interviewees defined growth as one of the reasons for M&A. In 80 % of all interviews a strengthened market position was stated as well. Aligned with that, the section others was chosen four times. In all of the cases with the same detailed description. Pressure given by the customer. As the customer wanted to decrease technical interfaces and only deal with one machine supplier instead of several. Due to that fact companies were forced to cooperate with other suppliers. Cooperation can have a huge variety, starting from strategic alliance ending up in a full integration as a result of M&A.

The question of the most challenging phase within the M&A activity was in 90% of the interviews answered with DD. The negotiation of the open items after a successful DD was mentioned one time. The indication shows clearly, that DD is seen as the most critical part of the whole M&A.

The question regarding the executed DD areas was answered in the following way.

Tab. 1 – Executed DD areas. Source: own research

Financial	10
Legal	10
Tax	10
Commercial	7
Operational	3
HR	6
Others (please name them):	8

There is a clear indication, that the traditional DD such as financial, legal and tax are always performed. HR DD was mentioned in 60% of the interviews, but it needs to be added, that three out of six interviewees added, that the HR DD was part of the legal DD and therefore mainly oriented on labor disputes and not on the personnel structure and the identification of experts and critical employees. When it comes to commercial DD, the statement was as well, that the execution is done in the majority of the cases, in 70%. Regarding the commercial DD 5 out of 7 people that mentioned the DD area added, that the commercial DD was mainly focused on the sales figures and not on the evaluation of the market and the role in the market of the target company. The operational DD also needs to be explained more detailed. The interviewees that mentioned operational DD all stated, that the focus here is mainly on the organizational chart and less on the processes. The section others was chosen in 80% of the interviews. Four times the technological DD was mentioned. Three times environmental DD was stated. In two cases cultural DD was announced. Three times organizational DD was defined. The interviewees that mentioned it also mentioned operational DD and specified, that organizational DD in their experience deals with the organizational chart, while the operational DD deals with the process analysis.

The next question deals with the best approach for the labor setup of the DD. The experts' opinion is giving a clear indication, as 90% of the answers are mentioning the team approach. The other answer mentioned the department approach. There was an add-on, to those the answer. Regarding the department approach it was mentioned, that it is seen as the most efficient one, but that it needs for sure also to be seen in combination with the company size. Regarding the SMEs a department approach is difficult to realize, if the company is not a private equity, only focused on M&As.

External consultants are always needed for the evaluation of legal aspects and tax aspects in the opinion of the interviewees. This is followed by HR, but it needs to be added, that the experts added in all cases, that this is only valid for legal disputes. For the financial DD external experts were mentioned in 70% of the cases. Commercial experts were seen as necessary in 50% of the answers. While operational experts are only needed in 30%. Two additional answers stated, that in the technological DD external experts are as well beneficial.

It was to be expected, that internal experts are mainly needed, were external experts are seen with less importance. Legal and tax were only mentioned twice. While commercial and operational are mentioned in almost all the answers. Interesting aspects were financial and HR, as they were mentioned double for the need of externals as well as for the need for internals. Regarding the financial DD the reason for the double mentioning within the area external as well as in the area internal is the following. The external consultants are especially needed, when the accounting principles between the target and the acquirer are different. External consultants therefore need to support in the transfer of the data into the same structure. The analysis of the data itself can be done by the consultant as well. In most of the cases this leads to the fact, that the KPIs chosen are not the ones used within the acquirer to control the company. In other words, the analysis based on the comparable structure is ideally executed by the acquirers' financial department. In the HR area the situation is similar. For legal disputes external consultants need to be involved. When it comes to the evaluation of the personnel structure the acquirer should be executing the DD itself. In the area others technological DD was mentioned in all seven cases. Additionally, organizational and cultural was mentioned one time.

The analysis of the quantitative part of the interviews already gives some more concrete indication on the challenges within the DD process. Out of the answers a first draft of a concept could be developed. Currently the analysis and the coding of the qualitative part of the interviews is ongoing and will be then used as well for the further specification of the concept.

## **6 INNOVATIVE DUE DILIGENCE APPROACH**

Based on the information gained out of the theories and the qualitative research a new concept for DD will be defined.

The target is to generate a decision basis for the M&A of a competing enterprise in the area of manufacturing SME by developing a scorecard model including KPIs and their relevant internal and or external benchmarks which enables the potential buyer an overall analysis of the actual data as well as an outlook to the future on a standardized and time efficient method (Winkler, 2013). The idea is to combine the structure of Strategic Controlling of a company in the PMI phase and the DD. A comprehensive, high-quality company evaluation is essential, taking the parameters of time and personnel into account. As mentioned above the outcome is, that the different areas of DD, such as legal, tax, financial, commercial, technical and environmental have mostly been separated from each other. The possible procedures have been described, and the problem areas in the individual areas have been pointed out (Kranebitter, 2002). The new development deals with the integration of the different levels and the holistic assessment. In

other words the different areas will be linked to each other. A company always needs to be seen as an integrated system. There are hierarchical dependencies between the areas examined during the DD, which must also be understood and assessed as such. The following figure is showing an example for dependencies within a company.

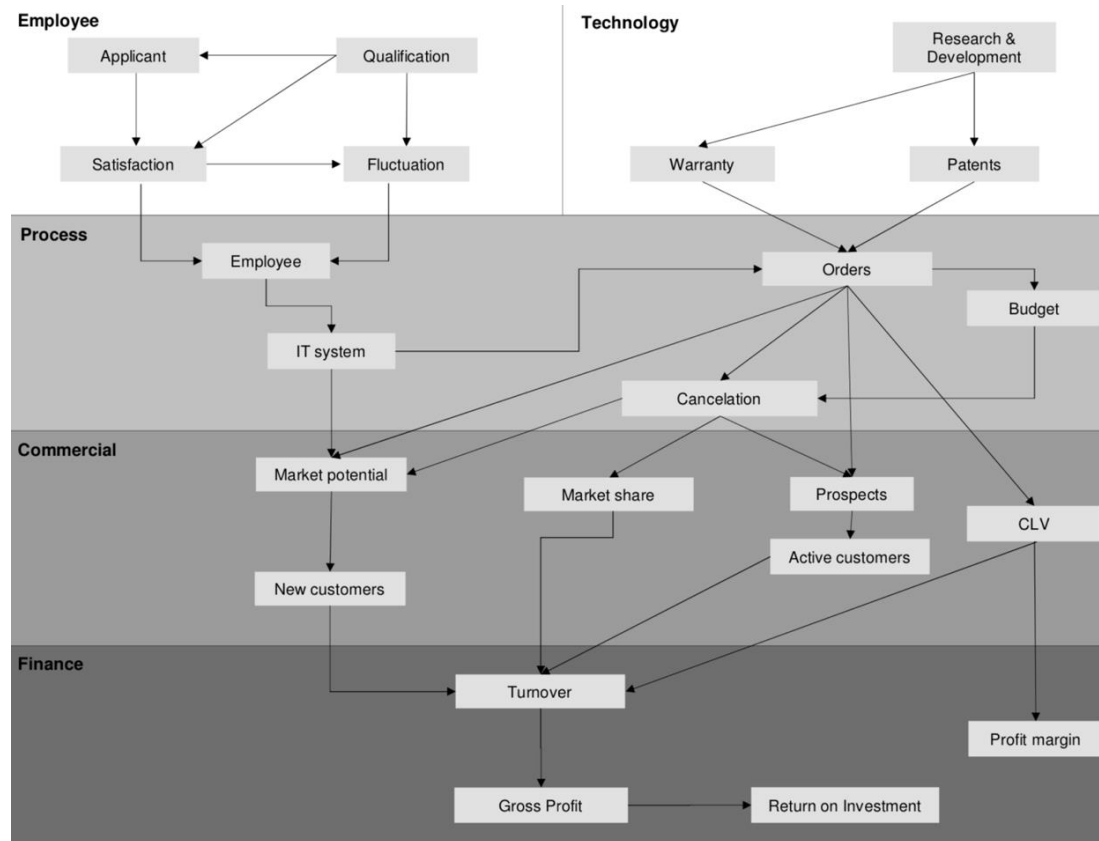

Fig. 3 – Dependencies within a company. Source: own research

The shown dependencies are the basis of a qualitative reasoning, which links the strategic targets of a company. It is difficult to define all connections, especially because the dependencies can go in both directions. But this is necessary to link the pre-existing checklists of the various DD through their interfaces, so that an integrated evaluation is possible (Winkler, 2013).

For all the dependencies of the strategic targets in the company, the KPIs need to be defined to make the dependencies measurable. Commercial and technical levels for example are directly influencing the financial level of the company. The quality standard and the innovations of the products out of the technical area are influencing the commercial level. Quality for example can be measured by the costs for warranty. As an absolute value is difficult to compare, a ratio needs to be formed. A concrete ratio can be the warranty cost to turnover ratio. For the sustainability of the company innovations are important. The innovations can be measured in R&D costs per turnover and total number of patents and their average time until expiry. In the next step the technological level is causing an effect on the process level, e. g. the orders by the customer. The quality of the order process can be measured in the order to quotation ratio. Furthermore the cancellation-order ratio is giving a good indication for the connection and the dependency between the commercial part of the company and the technological one. Thinking about the financial level, the market share is a result out of the quality of the product and the sales process, in other words out of the technological and the process level. The market share as one part of the commercial area is influencing the turnover. If the market share is big, the

turnover of the company is bigger and the power in the market is bigger as well. This has a direct influence on the gross profit and the result of the company.

Benchmarks, which depend on the individuality of the company, either from the market or from the company need to be taken into account. The experience and the existing knowledge as well as the resulting comparability of companies are greater in the case of acquisitions of competing companies than acquisitions of complementary companies up or down streaming the value chain. The new DD approach therefore relates to companies which are in direct competition with each other, which leads to the expansion of the market share (Winkler, 2013).

In the figure shown below an example for a dashboard including some examples for the defined KPIs and an evaluation according their benchmark is displayed. While in the lower part the evaluation of commercial KPIs are shown, the upper part shows the financial level and a selection of its key figures. The indicators are shown in different ways, which allows the evaluating employee to get a fast overview and to do further research on the ones in a critical stage.



Fig. 4 – Dashboard of KPIs. Source: own research

A model for the integrated DD process, which is assessed by all company components both on the actual situation as well as on the future capability, can be represented on the basis of the prevailing theories. A challenge can be seen in the individual processes of a company and the different data quality. These must first be made comparable to the evaluation of the resulting key figures (Winkler, 2013). In the international environment the challenge to create a common data base is even bigger, due to legal differences, but once this goal is achieved with a structured procedure the created measures can be used in an efficient way to evaluate the company and to decide about starting the negotiations of the M&A or to stop them on an early stage (Keuper, Häfner & von Glahn, 2006).

## **7 OUTLOOK FOR THE INNOVATIVE DUE DILIGENCE PROCEDURE**

The success and the usability of the new concept can be evaluated based on different parameters. In terms of efficiency it can be said, that based on the new concept the process can be streamlined. The major effect is a result out of the synergies gained during the integrated DD. As the different DDs are not executed separately from each other anymore the redundancies could be cut out of the process. During the kick-off event the process is presented to the target, the external and the internal DD participants. An overview with all the data required is distributed. The data is not provided by the target proactively but based on the concrete request out of the DD team. This already saves time at the end of the target. The different external consultants focus on the precise evaluation of their sub-area, but with a concrete objective of which data needs to be gathered and in which structure. This causes savings in time and finally in money. An interpretation is mainly needed for the qualitative aspects and during the transformation of the financial data into local GAAPs. The time spend on the preparation of the individual DD report can be saved, as the report is mainly KPI driven. The KPIs are part of the strategic controlling of the potential acquirer. This causes the fact, that for the interpretation of the numbers no external advisor is needed.

In the new concept, the KPIs defined, allowed an integrated view. The weaknesses of the individual evaluation of every discipline out of the DD could be improved. Based on the fact, that the case study is based on real data of the past and based on the fact that it is known, how the company developed after the decision of the potential acquirer not to continue with the M&A after the DD, it is possible to match the result of the post executed DD based on the original data and the generated indication with the actual development. In other words, overall the original decision not to acquire the target company was based on the actual development of the company wrong. The recommendation provided of the new concept would have been to keep on going with the M&A process.

Companies are limited in knowledge and capacity within the DD process. By establishing a standardized procedure companies can first create the knowhow of the DD process in house, which makes them being more independent from external consultants. This will already decrease the costs for coordination expenses within the company and the fees to be paid directly to the external consultants. Furthermore, it will be a concept, which can be multiplied and used for different DD up to come in the future. Considering the scale effect, the one-time set up cost will pay off with the number DD as well.

As the approach of the DD is new and generates a new and faster way of the DD this will not only save the time of the potential buyer but as well of the potential seller. It makes the DD leaner and more efficient. The collaboration will be easier and this will increase the satisfaction of both parties involved. In every market the players know each other. M&As are taking place in every one of them not depending on the business area. They are delicate as the involved



parties do have different interests. A structured and transparent procedure helps to understand the parties to understand each other better. At the end the atmosphere during the DD process will be better, it won't even be important, if the merger is finally going to happen, as the parameters are clear and understandable for everyone. This will help to increase the respect and the reputation of the potential buyer. As the rest of the market players will receive this information as well out of the market this can be a competitive advantage of future sales, when companies are searching for interested buyers. The market will take note of the innovative approach which might even cause an interest of other companies in adapting to the model, which could even cause a new business model for the future.

The next steps for the research are the termination of the coding and the analysis of the qualitative part of the expert interviews. Based on that the concept will be further specified. Finally, a case study based on a real case will be executed to proof the functionality of the concept.

## References

- Bruner, R. F., & Perella, J. R. (2004). *Applied Mergers and Acquisitions*. Hoboken: Wiley and Sons.
- Coyle, B. (2000). *Mergers and Acquisitions*. London: Fitzroy Dearborn Publishers.
- Döring, N., & Bortz, J. (2016). *Forschungsmethoden und Evaluation in den Sozial- und Humanwissenschaften*. Berlin: Springer Heidelberg.
- Fernandes, K. J., Raja, V., & Whalley, A. (2006). Lessons from implementing the balanced scorecard in a small and medium size manufacturing organization. *Technovation*, 26(5-6), 623-634. doi: 10.1016/j.technovation.2005.03.006
- Gates, S., & Very, P. (2003). Measuring Performance During M&A Integration. *Long Range Planning*, 36(2), 167-185. doi: 10.1016/S0024-6301(03)00004-9
- Hauser, H. E., Kay, R., & Boerger, S. (2010). Unternehmensnachfolgen in Deutschland 2010 bis 2014 - Schätzung mit weiterentwickeltem Verfahren. IfM-Materialien, 198. Retrieved from <http://hdl.handle.net/10419/51541>
- Horváth, P. (2011). *Controlling*. Munich: Vahlen Verlag.
- Howson, P. (2016). *Commercial Due Diligence: The Key to Understanding Value in an Acquisition*. Burlington: Gower Publishing.
- Jansen, S. A. (2016). *Mergers & Acquisitions*. Wiesbaden: Springer Verlag.
- Kaplan, R. S., & Norton, D. P. (1996). *Balanced Scorecard – Translating strategy into action*, Boston: Harvard Business Press.
- Keuper, F., Häfner, M., & von Glahn, C. (2006). *Der M&A-Prozess - Konzepte, Ansätze und Strategien für die Pre- und Post-Phase*. Wiesbaden: Gabler Verlag.
- Koch, W., & Wegmann, J. (2002). *Praktiker Handbuch Due Diligence - Analyse mittelständischer Unternehmen*. Stuttgart: Schäffer-Poeschel Verlag.
- Kranebitter, G. (2002). *Due Diligence – Risikoanalyse im Zuge von Unternehmenstransaktionen*. Munich: Verlag moderne industrie.
- Mayring, P. (2003). *Qualitative Inhaltsanalyse*. Weinheim: Beltz.

- Sargeant, J. (2012). Qualitative Research Part II: Participants, Analysis, and Quality Assurance. *Journal of Graduate Medical Education*, 4(1), 1-3. doi: 10.4300/JGME-D-11-00307.1
- Schneider, K. (2016). *Due Diligence in der Praxis*. In Haufe. Retrieved from [http://www.haufe.de/unternehmensfuehrung/profirma-professional/ue-due-diligence-in-der-praxis\\_idesk\\_PI11444\\_HI5520908.html](http://www.haufe.de/unternehmensfuehrung/profirma-professional/ue-due-diligence-in-der-praxis_idesk_PI11444_HI5520908.html)
- Scott, C. (2001). *Due Diligence in der Praxis; Risiken minimieren bei Unternehmens-transaktionen*. Wiesbaden: Gabler Verlag.
- Stern, L. (1993). The Crucial Role of Due Diligence. Mortgage Banking. Retrieved from <https://www.questia.com/magazine/1G1-14976213/the-crucial-role-of-due-diligence>
- Russ, W. (2018): Due Diligence. In Becker, K., Castedello, M., & Esser, I. (Eds.): *Bewertung und Transaktionsberatung: Betriebswirtschaftliche Bewertungen, Due Diligence, Fairness Opinions*. Düsseldorf: IDW Verlag GMBH.
- Unzeitig, E., & Kulhavy, H. (2009). Due Diligence im Überblick. In Littkemann, J. (Ed.): *Beteiligungscontrolling*. Herne, Germany: NWB.
- Winkler, R. (2013). *Corporate Governance als Werttreiber der Due Diligence*. Hamburg: Verlag.
- Wirtz, B. W. (2003). *Mergers & Acquisitions Management*. Wiesbaden: Gabler.

## Contact information

### Christoph Müller, MSc, BSc

Vysoká škola manažmentu v Trenčíne / City University of Seattle programs Trenčín  
Bezručova 64, 91101 Trenčín, Slovakia  
E-mail: christoph.mueller.msc@gmail.com  
ORCID: 0000-0003-0229-3612

doi: 10.7441/dokbat.2019.077

# SUPPLY CHAIN MANAGEMENT TOWARD INDUSTRY 4.0: A LITERATURE REVIEW

*Vy T. T. Nguyen, Tam T. T. Nguyen*

## **Abstract**

The Industrial Revolution 4.0 has been taking place and developing quickly and strongly. Like the previous revolutions, this Fourth industrial revolution promises to bring enormous benefits to all fields such as industry structure, labour supply and demand, production management system. Supply chain is not out of this trend. The article aims to provide a review on the application of Industry 4.0 in supply chain management. Using the desk research methodology, the author first gives an overview about the concepts and features of Industry 4.0 and supply chain management. Then, we synthesize typical technologies of Industry 4.0 popularly applied in supply chain management including: *Internet of Things, Augmented reality, and Autonomous System*. The results show evidences for both theoretical and empirical application of the mentioned technologies in supply chain management, especially in to key sectors: transportation and warehousing.

**Keywords:** *Industry 4.0; Supply Chain Management, Internet of Things (IoT), Augmented reality (AR), Autonomous System*

## **1 INTRODUCTION**

Industry 4.0 is the short expression of applying the power from digital and intelligent technology to production activities, to each stage of the value chain. Digital and intelligent technology is weaving into every corner of daily life and creating new values for economies in general and manufacturing, commercial and service businesses in particular. This requires businesses to adapt quickly before being left behind.

Supply chain is one of the industries highly applying the 4.0 technology advances. Managing this service through information technology will create new business models, new distribution channels, and break the traditional supply chain design (Iddris, 2018, Xue et al., 2013 ). Industry 4.0 will be the core platform for development of supply chain management (SCM) in the future, and not only will large companies participate in solving SCM's problems, but start-ups will also offer breakthrough solutions in each stage of the supply chain. According to the survey report of Capgemini Consulting and GT Nexus (GTNexus, 2016) on the trend of digital supply chain transformation, 70% of about 340 largest global manufacturing and retail organizations from over 20 different countries believe that industrial revolution, especially the digitalization would significantly affect supply chain structures in different sectors.

In order to take full advantage of the potentials of Industry 4.0, manufacturing and retail businesses need to have an overview of SCM and the application of Industry 4.0 in this industry. Hence, this article aims to give an overview of Industry 4.0 and its application in supply chain management and development, which in turn will help to enhance the competitiveness of those business applied.

## **2 INDUSTRY 4.0**

The concept of 'Industry 4.0' or 'the Fourth Industrial Revolution' were first introduced at the Hannover Industrial Fair in Germany in 2011 (Kagermann, 2013). Industry 4.0 was born to

replace Industry 1.0, 2.0 and 3.0, in order to apply digital and intelligent management in manufacturing processes. This is the current trend in automation and data exchange in production technology. It includes cyber-physical systems, Internet of Things, cloud computing and cognitive computing. The Industry 4.0 is based on the Industry 3.0, which combines technologies together, blurring the boundaries between physics, digital and biology (Katz et al., 2017).

## 2.1 Characteristics of Industry 4.0

In order to implement and apply the technology of Industry 4.0, businesses need to take into account the following characteristics of Industry 4.0 (Smit et. al, 2016; Vaidya et al., 2018):

- 1) *The interconnectivity*: The ability of connecting people, machines and devices together using Internet of Things and Internet of Services and People;
- 2) *The virtualizability*: The ability of information systems to create a virtual version of the real world by enriching digital factory models with sensor data. This requires the collection of raw sensor data to provide more valuable contextual information;
- 3) *The decentralizability*: The ability of the virtual-cyber system to allow the decision making and the execution of tasks as automatically as possible;
- 4) *The real-time capability*: the ability of instantly collecting and analysing data for the derived insights.

## 2.2 Main pillars of Industry 4.0

The next part will give an overall introduction about main nine pillars of Industry 4.0, which are applied to achieve the above features, including (Brettel et al., 2014; Hofmann & Rüsçh, 2017; Erboz, 2017; Vaidya et al., 2018):

*Internet of Things (IoT)*: refers to billions of physical devices around the world currently connected to the internet, collecting and sharing data. Thanks to its cheap processor and wireless network, it can turn everything into a part of the IoT. This adds "digital intelligence" to devices, allowing them to communicate without people involved and uniting the digital and physical worlds. Smart city projects being filled with sensors to help us understand and control the environment is an example of apply IoT.

*Autonomous system*: is the system using collaborative robots to reduce the gap between traditional robots and human workers These robots are designed to function in a similar way to humans, with the added ability to monitor and transmit data (Table 1).

Tab. 1 – Examples of autonomous systems used in different companies. Source: Vaidya et al. (2018)

Sr.no.	Name of robot	Company	Function of robot
1	Kuka LBR iiwa	Kuka	Lightweight robot for sensitive industrial tasks
2	Baxter	Rethink Robotics	Interactive production robot for packaging purpose
3	BioRob Arm	Bionic Robotics	Use in close proximity with humans
4	Roberta	Gomtec	6-Axis industrial robot used for flexible and efficient automation

*Big data and analytics*: big data is the term used to refer to a very large and complex data set that traditional data processing tools and applications cannot handle. What really brings value from big data organizations is data analytics. Without analytics, it is just a data set with limited

use in business. By analysing big data, companies can have benefits such as increased revenue, improved customer service, greater efficiency, and increased competitiveness, especially for transportation and supply chain sectors (Kache & Seuring, 2017).

*Simulation:* utilizes real-time data to reflect the physical aspect of product manufacturing and development processes in a virtual environment. These models can be used to run more efficient tests for optimized installation and processes before production beginning, helping reduce downtime and improving quality. The 3D Simulation of Cutting Forces in Turning Inconel-718 is an example for the application of this technology in the production. (Kumar et al, 2017).

*System Integration:* Many production information systems are not always effectively integrated. With improved system integration, companies can become more connected with each other both externally and internally. This will result in an advanced and effective production environment that enables real-time production adjustments. The description of system integration is illustrated in Figure 1.

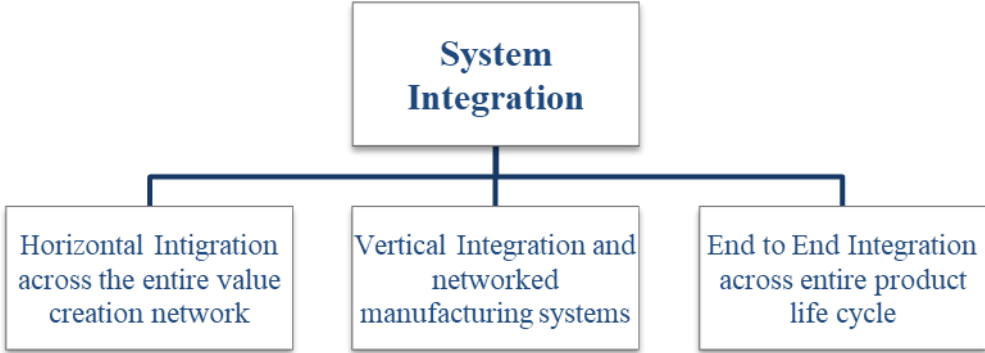

Fig. 1 – Description of System Integration. Source: Vaidya et al. (2018)

*Cyber Physical Systems and Cyber security:* Cyber Physical Systems is defined as systems in which natural and artificial (physical aspect) systems are tightly interconnect with computing, communication and control systems (cyber aspect). This system is used to protect important industrial systems and production lines from cyber security threats, or to improve the quality of information needed to plan, optimize and operate production systems. Key features of Cyber Physical Systems are decentralizable and automation capacity.

*Cloud computing:* is also known as virtual server computing. The term ‘cloud’ is a metaphor. It is a model in which information is permanently stored at a number of servers on the internet and only temporarily stored on guest computers, including laptops., entertainment centres, computers in enterprises, etc. Cloud computing will provide us with services and software regardless of which server we are working with, so it helps us have a much wider digital infrastructure.

*Additive Manufacturing (AM):* is a method of manufacturing products by “covering” each layer of materials on top of each other, modelled after the designs already drawn on CAD software. With traditional manufacturing processes, to get the complete product requires workers to drill, stamping, and turning on a block of material. With AM, extremely thin layers of material are superimposed on each other to create a complete 3D product. The latter layer adheres to the previous layers by completely melting (or partially) the ingredients that make up the product.

*Augmented Reality:* Augmented Reality (AR) is the technology that allows people to view objects in the real world through electronic devices. Then, apart from what the naked eye can see, electronic devices also tell us other information related to the object being observed. For examples, equipped with image recognition technology, Blippar is able to provide additional

information about products, brands, and companies whenever users point the device at advertisements in newspapers, magazines, or posters... Blippar's major partners include several well-known brands around the world such as Unilever, Nestle, Xbox, Samsung, LG. (Irshad & Rambli, 2015; van Arnhem, 2016).

### 3 METHODOLOGY

The main methodology for conducting study is the desk research approach. In more details, we collect and accumulate a range of selected studies from peer-reviewed journals and proceedings as well as specialized reports in order to provide the above common understandings about Industry 4.0 with its main features and pillars, as well as the popular applications of Industry 4.0's technology in SCM.

## 4 INDUSTRY 4.0 APPLICATION IN SUPPLY CHAIN MANAGEMENT

### 4.1 Supply chain and Supply chain management

To reach consumers, any product must go through a long journey, including the coordination of many stages from raw material suppliers, to processing factories, through shipping units, and followed by distribution centres, wholesale and retail stores. This process is known as the supply chain, defined as a system of organizations, people, information, activities and resources related to the transfer of products/services from suppliers to customers. Especially, transportation and warehousing control are considered as the key issues needed more managerial attention because they are the important links between subjects and partners in the chain, ensuring the punctuality, product's self-life and reducing cost and errors. (Lambert et al., 1998; Beamon, 1998; Wilson, 2005) (Figure 2).

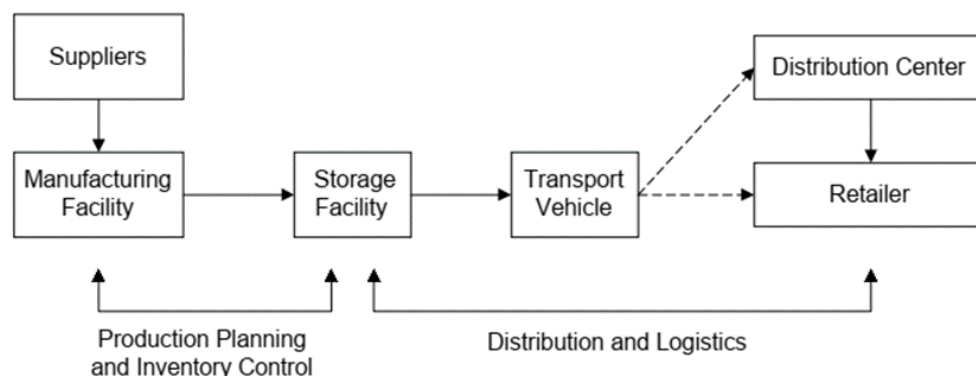

Fig. 2 – Description of Supply chain management. Source: Beamon (1998)

In the current business, when the competitiveness of the market is increasingly fierce, the management of supply chain will often have a great impact on the performance of the enterprise. One of the trends to create the competitiveness among enterprises is application of technological achievement of Industry 4.0.

### 4.2 Industry 4.0 and its application in supply chain management

The following part will introduce some main popularly technical and digital applications of Industry 4.0 in supply chain management, focusing on achieving effective performance for transportation and warehousing, which include: Internet of Things (IoT); Augmented reality technology (AR); and Autonomous System.

## Internet of Things (IoT)

According to Omale (2018), it is estimated that by 2020, more than 50 billion items will be connected to the internet, providing a great opportunity of \$1.9 trillion for SC services. Thus, IoT will solve many problems applied in various stages of SCM.

**In warehousing**, the IoT can be integrated in warehouses through sensors installed at shelves and products. Information about location, purchases orders, volume, etc, will be updated in real time from pallets and being sent to the warehouse management system (WMS), which helps to reduce the cost actions and time of tallying (Ding,2013; Qiu et al.,2015; Lee et al. 2018). Gate-mounted cameras can be used to detect failures and track defects. One of the specific application technologies is Radio-Frequency Identification (RFID). This is a common technology in manufacturing to identify, record and control moving objects. Figure 3 illustrates the solution for warehouse management of American Barcode and RFID (Wang et al., 2014; Alyahya, 2016);



Fig. 3 – Industry 4.0 solution for warehouse management. Source: ABR (2019)

**In transportation**, the IoT also offers a better solution for transportation management by optimizing vehicle free time or making automatic vehicle maintenance forecasts based on updates from vehicle-mounted sensors. The IoT provides a comprehensive delivery solution for consumers through smart delivery capabilities, such as the delivery to customers' car trunks via encrypted codes. Before, if we have seen the connection between communication network devices such as routers, servers, PCs or smart phones, we can now imagine the internet connection of cranes and specialized vehicles. or containers thanks to the presence of Internet of Thing. Or taking a simple equipment of IoT, that is sensor equipment. The fuel level sensor used to confirm the level of oil currently in the tank, the amount of oil loaded and removed. The sensor also helps to control vehicle tonnage so that the manager can prevent the sudden loading and unloading of freight vehicles, minimizing the risk of cargo loss, especially useful in preventing overload, ensuring traffic safety (Karakostas, 2013; Sherly & Somasundareswari, 2015; Yang & Gong, 2017; Zoch, 2017);

### **Augmented reality technology (AR)**

In SCM, this technology can help workers quickly identify shipment information, thereby speeding up the time to process goods. DHL has tested AR in Europe and the United States in following activities (Glockner et al., 2014).

**In warehousing**, by equipping AR glass warehouse, workers can identify items in real time, showing the optimal route for order picking, helping reduce time in stock. In addition, workers do not need to scan packages, glasses can do for them (Cirulis & Ginters, 2013; Glockner et al., 2014; Porter & Heppelmann, 2017).

**In transportation**, before shipping, an AR system can assist in ensuring that the shipment complies with the relevant import and export regulations, in which the device is used to scan commercial or good documents and automatically suggest changes or modifications to the commodity code classification. Furthermore, AR also helps truck drivers take inventory of goods quickly. In the future, wearable AR devices may incorporate 3D depth scanners and sensors to identify the number of individual pallets or blocks (Glockner et al., 2014). For other aspect, the AR is also efficiently applied in public transportation for mobile users (Kamilakis, 2016). Especially, in last-mile delivery, drivers spend a lot of the time to find the right package in the truck for delivery, and they must rely on their memory during the shipment. With AR devices highlighting the appropriate package to notify the driver, the search process will be more convenient and significantly accelerate at each delivery. Each driver can get important information about a specific lot by looking at it with their AR device. This information may include the type of cargo being shipped, the weight of each shipment, the shipping address, and whether it is fragile or required to be placed in a specific location to avoid damage (Tatasciore, 2018).

### **Autonomous system**

Autonomous system will help minimize errors arising in supply chain processes and improve labour productivity to a new level (Ameri & McArthur, 2013). The concept of "cobot"-collaborative robot (robot collaborating with people) was born to help liberate human labour from manual work, thereby improving productivity through automation and reducing danger (Dossou & Nachidi, 2017).. Amazon is a pioneer in scaling up the process of using cobot for order fulfilment based on technology from Kiva Systems (an Amazon Robotics start-up acquired in 2012). The cobot is equipped with high-resolution cameras, pressure sensors, and the ability to self-study to be easily programmed to support workers in the stages of picking, packaging and sorting. In addition, the cobot can easily move between warehouses, supporting the completion of e-commerce orders better, providing flexibility in warehouse management. In addition, DHL is also testing Sawyer robots to support the process of distribution, unloading, transporting goods (Glockner et al., 2014).

## **5 RESULTS AND DISCUSSION**

From the synthesis and analysis of both selected theoretical and practical researches, this paper show that when the technologies of the Industry 4.0 are applied, the supply chain management and performance are likely to achieve many benefits. In particular, transportation and warehousing are the fields that may witness the most positive changes. With the application of Internet of Things, Augmented reality, and Autonomous System, enterprises can detect failures and track defects, identify items in real time, showing the optimal route for order picking, helping reduce time of tallying and storing in warehousing control. For transportation, the technical revolution can help optimizing vehicle free time or making automatic vehicle maintenance forecasts, delivering goods more quickly with effective cost.



However, there are still a lot of difficulties for the application of Industry 4.0 on SCM, particularly to developing countries. Obstacles are raised including the high cost of equipment, the inadequate technical and digital infrastructure system among stakeholders, as well as the issue of manpower qualification and skills.

## 6 CONCLUSION

Industry 4.0 has brought many useful applications to industries and services, including the supply chain management. Specifically, the article clarifies the application of three common techniques in this industry, including: Internet of Things, Augmented reality, and Autonomous System. For further studies, we aim to go into depth about the feasibility analysis in the application of these techniques in developing countries, including Vietnam. This work requires analysis and comparison of successful experiences of other countries in the world, especially developed countries.

### References

- ABR. (2019). *Warehouse Inventory Management System: Proven solution for warehouse management*. Retrieved from <https://www.abr.com/warehouse-inventory-management-system/>
- Alyahya, S., Wang, Q., & Bennett, N. (2016). Application and integration of an RFID-enabled warehousing management system—a feasibility study. *Journal of Industrial Information Integration*, 4, 15-25. doi: 10.1016/j.jii.2016.08.001
- Ameri, F., & McArthur, C. (2013). A multi-agent system for autonomous supply chain configuration. *The International Journal of Advanced Manufacturing Technology*, 66(5-8), 1097-1112. doi: 10.1007/s00170-012-4392-9
- Beamon, B. (1998). Supply chain design and analysis: Models and methods. *International journal of production economics*, 55(3), 281-294. doi: 10.1016/S0925-5273(98)00079-6
- Brettel, M. et al. (2014). How Virtualization, Decentralization and Network Building Change the Manufacturing Landscape: An Industry 4.0 Perspective. *International Journal of Mechanical, Aerospace, Industrial, Mechatronic and Manufacturing Engineering*, 8(1), 37-44. Retrieved from [https://formamente.guideassociation.org/wp-content/uploads/2017\\_1\\_03\\_Brettel.pdf](https://formamente.guideassociation.org/wp-content/uploads/2017_1_03_Brettel.pdf)
- Capron, J. (2017). *A Look into Logistics Automation*. Retrieved from [https://www.roboglobal.com/insights/white\\_papers/a-look-at-logistics-automation/](https://www.roboglobal.com/insights/white_papers/a-look-at-logistics-automation/)
- Cirulis, A., & Ginters, E. (2013). Augmented reality in logistics. *Procedia Computer Science*, 26, 14-20. doi: 10.1016/j.procs.2013.12.003
- Ding, W. (2013). Study of smart warehouse management system based on the IOT intelligence computation and evolutionary computation. *Intelligence Computation and Evolutionary Computation. Results of 2012 International Conference of Intelligence Computation and Evolutionary Computation*, 203-207. doi: 10.1007/978-3-642-31656-2\_30
- Dossou, P. E., & Nachidi, M. (2017). Modeling supply chain performance. *Procedia Manufacturing*, 11, 838-845. doi: 10.1016/j.promfg.2017.07.186
- Erboz, G. (2017, November). How to Define Industry 4.0: Main Pillars Of Industry 4.0. *7th International Conference on Management (ICoM 2017)*. Retrieved from

[https://www.researchgate.net/publication/326557388\\_How\\_To\\_Define\\_Industry\\_40\\_Main\\_Pillars\\_Of\\_Industry\\_40](https://www.researchgate.net/publication/326557388_How_To_Define_Industry_40_Main_Pillars_Of_Industry_40)

- Glockner, H., Jannek, K., Mahn, J., & Theis, B. (2014). *Augmented reality in logistics*. Retrieved from [https://www.dhl.com/content/dam/downloads/g0/about\\_us/logistics\\_insights/csi\\_augmented\\_reality\\_report\\_290414.pdf](https://www.dhl.com/content/dam/downloads/g0/about_us/logistics_insights/csi_augmented_reality_report_290414.pdf)
- GT Nexus (2016). *Research Report: The Current and Future State of Digital Supply Chain Transformation*. Retrieved from <http://mktforms.gtnexus.com/rs/979-MCL-531/images/GTNexus-Digital-Transformation-Report-US-FINAL.pdf>
- Hofmann, E., & Rüsçh, M., (2017). Industry 4.0 and the current status as well as future prospects on logistics. *Computers in Industry*, 89, 23-34. doi: 10.1016/j.compind.2017.04.002
- Iddris, F. (2018). Digital Supply Chain: Survey of the Literature. *International Journal of Business Research and Management*, 9(1), 47-61. Retrieved from <http://www.diva-portal.org/smash/record.jsf?pid=diva2:1231749>
- Irshad, S., & Rambli, D. R. A. (2015). User experience satisfaction of mobile-based AR advertising applications. *International Visual Informatics Conference*, 432-442. doi: 10.1007/978-3-319-25939-0\_38
- Kache F. & Seuring S. (2017). Challenges and opportunities of digital information at the intersection of Big Data Analytics and supply chain management. *International Journal of Operations & Production Management*, 37(2017), 10-36. doi: 10.1108/IJOPM-02-2015-0078
- Kagermann, H. Helbig, J., Hellinger, A., & Wahlster, W. (2013). Recommendations for Implementing the Strategic Initiative INDUSTRIE 4.0. Retrieved from <https://www.din.de/blob/76902/e8cac883f42bf28536e7e8165993f1fd/recommendations-for-implementing-industry-4-0-data.pdf>
- Kamilakis, M., Gavalas, D., & Zaroliagis, C. (2016). Mobile user experience in augmented reality vs. maps interfaces: A case study in public transportation. *International Conference on Augmented Reality, Virtual Reality and Computer Graphics*, 388-396. doi:10.1007/978-3-319-40621-3\_27
- Karakostas, B. (2013). A DNS architecture for the internet of things: A case study in transport logistics. *Procedia Computer Science*, 19, 594-601. doi: 10.1016/j.procs.2013.06.079
- Katz, H. R. et al. (2017). Digital Ecosystems: Innovation and Disruption in Latin America, GA Center of Digital Business Transformation. Retrieved from [https://grupoassa.com/assets/img/insights/Abstract\\_Ecosistemas\\_Digitales\\_ING.pdf](https://grupoassa.com/assets/img/insights/Abstract_Ecosistemas_Digitales_ING.pdf)
- Kumar, M. S., Reddy, S. R., & Vasu, V. (2017). A 3-D simulation and experimental study of cutting forces in turning inconel-718. *Materials Today: Proceedings*, 4(9), 9942-9945. doi: 10.1016/j.matpr.2017.06.298
- Lambert, D. M., Cooper, M. C., & Pagh, J. D. (1998). Supply chain management: implementation issues and research opportunities. *The international journal of logistics management*, 9(2), 1-20. doi: 10.1108/09574099810805807
- Lee, C., Lv, Y., Ng, K., Ho, W., & Choy, K. (2018). Design and application of Internet of things-based warehouse management system for smart logistics. *International Journal of Production Research*, 56(8), 2753-2768. doi: 10.1080/00207543.2017.1394592

- Omale, G. (2018). *Gartner Identifies Top 10 Strategic IoT Technologies and Trends*. Gartner. Retrieved from <https://www.gartner.com/en/newsroom/press-releases/2018-11-07-gartner-identifies-top-10-strategic-iot-technologies-and-trends>
- Porter, M. E., & Heppelmann, J. E. (2017). Why every organization needs an augmented reality strategy. *Harvard Business Review*, 95(6), 46-57. Retrieved from <https://www.hbs.edu/faculty/Pages/item.aspx?num=53458>
- Qiu, X., Luo, H., Xu, G., Zhong, R., & Huang, G. Q. (2015). Physical assets and service sharing for IoT-enabled Supply Hub in Industrial Park (SHIP). *International Journal of Production Economics*, 159, 4-15. doi: 10.1016/j.ijpe.2014.09.001
- Sherly, J., & Somasundareswari, D. (2015). Internet of things based smart transportation systems. *International Research Journal of Engineering and Technology*, 2(7), 1207-1210. Retrieved from <https://pdfs.semanticscholar.org/7bfe/05e20ce3845bd940d596223591fab0490c9.pdf>
- Smit, J., Kreutzer, S., Moeller, C., & Carlberg, M. (2016). *Industry 4.0*. European Parliament. Retrieved from [http://www.europarl.europa.eu/RegData/etudes/STUD/2016/570007/IPOL\\_STU\(2016\)570007\\_EN.pdf](http://www.europarl.europa.eu/RegData/etudes/STUD/2016/570007/IPOL_STU(2016)570007_EN.pdf)
- Stoltz, M. H., Giannikas, V., McFarlane, D., Strachan, J., Um, J., & Srinivasan, R. (2017). Augmented reality in warehouse operations: opportunities and barriers. *IFAC-PapersOnLine*, 50(1), 12979-12984. doi: 10.1016/j.ifacol.2017.08.1807
- Tatasciore, D. (2018). *DelivAR: An Augmented Reality Mobile Application to Expedite the Package Identification Process for Last-mile Deliveries*. Retrieved from <https://www.researchgate.net/publication/329687562>
- Vaidya, S., Ambad, P., & Bhosle, S. (2018). Industry 4.0—a glimpse. *Procedia Manufacturing*, 20, 233-238. doi: 10.1016/j.promfg.2018.02.034
- van Arnhem, J. P. J. (2016). Mobile Apps for Libraries: Exploring Blippar for Education. *The Charleston Advisor*, 17(4), 53-57. doi: 10.5260/chara.17.4.53
- Wang, L., Da Xu, L., Bi, Z., & Xu, Y. (2014). Data cleaning for RFID and WSN integration. *IEEE transactions on industrial informatics*, 10(1), 408-418. doi: 10.1109/TII.2013.2250510
- Wilson, R. (2005). Council of Supply Chain Management Professionals. *16th Annual State of Logistics Report*. Retrieved from [https://cscmp.org/CSCMP/Develop/Reports\\_and\\_Surveys/State\\_of\\_Logistics\\_Report/CSCMP/Develop/Reports\\_and\\_Surveys/State\\_Logistics\\_Report](https://cscmp.org/CSCMP/Develop/Reports_and_Surveys/State_of_Logistics_Report/CSCMP/Develop/Reports_and_Surveys/State_Logistics_Report)
- Xue, L., Zhang C., Ling H., Zhao X. (2013). Risk Mitigation in Supply Chain Digitization: System Modularity and Information Technology Governance, *Journal of Management Information Systems*, 30(2013), 325-352. doi: 10.2753/MIS0742-1222300110.
- Yang, S., & Gong, C. (2017). Research of Petroleum Well Fuel Pump Measurement & Control System Based on Internet of Things Technology. *2017 International Conference on Computer Network, Electronic and Automation (ICCNEA)*, 431-436. doi: 10.1109/ICCNEA.2017.111
- Zoch, D. (2017). *U.S. Patent Application No. 14/870,018*. Retrieved from <https://www.uspto.gov/patents-application-process/checking-application-status/search-application>

## **Contact information**

### **Vy T. T. Nguyen**

Banking University of Ho Chi Minh City, Faculty of International Economics

36 Ton That Dam Street, District 1, Ho Chi Minh City, Vietnam

E-mail: [vyntt@buh.edu.vn](mailto:vyntt@buh.edu.vn)

ORCID: 0000-0002-4964-7396

### **Tam T. T. Nguyen**

Banking University of Ho Chi Minh City, Faculty of Accounting and Auditing

36 Ton That Dam Street, District 1, Ho Chi Minh City, Vietnam

E-mail: [Tamntt@buh.edu.vn](mailto:Tamntt@buh.edu.vn)

ORCID: 0000-0001-5473-2192

doi: 10.7441/dokbat.2019.078

# FACTORS INFLUENCING INFLATION IN THE CZECH REPUBLIC

*Sára Novorytová*

## **Abstract**

Inflation has become an increasingly important economic subject and an important focus for central banks both in the Eurozone under the watchful eye of the European Central Bank. Central bankers outside the Eurozone enjoy a more national currency centric level of focus and independence. For the Czech Republic the main aim of the central bank is to take care of price stability. Primary for this reason is necessary to understand which factors influence inflation rate, the most. In a compact yet open economy such as Czech Republic, inflation can be caused by many factors. These factors either caused by economically or influenced by external factors apart from economy. The Czech economy is porous with significant niche dynamics, thus externalities factor in the inflation dynamics. The aim of the paper is to analyse main inflation determinants of the Czech economy and to determine the magnitude of their influence through regression analysis. The analysis parameter captures between 2001 to 2017 on monthly data. Regression analysis with OLS estimator is used. By evaluating the data, this discovery reveals that factors such as real effective exchange rate, monetary aggregate M2, import prices and inflation rate in Germany influence inflation in the Czech Republic to a great extent. These results clearly correspond with economic theory. This research is based on an extended data capture frame and exclusively with data for the Czech Republic. Basically variables which are in line with the basic economic theory are used in this model. This research can serve as a basic theoretical frame for further detailed research.

*Keywords: Inflation rate, determinants, regression analysis, OLS*

## **1 INTRODUCTION**

In general, inflation is one of the most frequently monitored macroeconomic indicators, which serves for a comparative analysis of the economic position of all economies. According to the inflation rate, the governments or central banks, of each individual country, choose their monetary policy or fiscal policy.

Inflation can be defined as a rise of the price level where there is a reduction in the purchasing power of money and, of course, this reduces the amount of goods and services that the economic subjects can buy for that money unit. Concisely expressed, inflation eroded the purchasing power of money. Beginning in 1998, the Czech National Bank started to target inflation, leaving the fixed exchange rate and transitioned to the floating rate system. In so doing, the Czech Republic becomes the first transforming economy to successfully use and effectively apply the inflation targeting system present in the economy today. The CNB can rightly boast of establishing some of the best models for inflation forecasting of its peers (CNB, 2019).

In order to correctly create a forecast for future inflation developments, it is necessary to know precisely direct and indirect determinants that have both influences on the inflation rate.

The aim of this paper is to analyse inflation determinants selected in connection with economic theory and to determine the magnitude of their influence through regression analysis. The analysis is carried out on monthly data available from ARAD databases, Eurostat, between 2001 and 2017. Number of observations is 203.

The remainder of this paper is structured as follows. The role of inflation determinants is described in the Section 2. Section 2 also summarises existing empirical studies. Used methods and data are defined in the Section 3. Results are introduced in the Section 4. We conclude and discuss results in the last section 5.

## 2 THEORETICAL BACKGROUND

There are many views on what factors affect the rate of inflation and the corresponding influences. Perhaps all studies that deal with the rate of inflation and the macroeconomic variables affecting it work with common inflation determinants such as interest rate, exchange rate and gross domestic product or other indicator of the output of the economy. These three factors have a direct influence on inflation rate and are thus a theoretical basis of common determinants of inflation in any world economy. To specify other selected determinants, it is necessary to look at the given economy for which the model is created. Therefore, in this work, monetary policy of the Czech National Bank plays a major role in selecting variables in the model. The Czech National Bank takes care of price stability in monetary policy. Every quarter, economists from CNB compile an inflation report. It evaluates past inflation and prepares inflation forecasts for the future at the monetary policy horizon 12-18 months. The inflation forecast is key information in particular in the approach to setting monetary policy interest rates that determine inflation. Also Dellas and collective (2018) mention that the accuracy of inflation forecasts has important implications for macroeconomic stability and real interest rates in economy. Erroneous forecasts destabilize output, undermine the conduct of monetary policy under inflation targeting and affect the cost of both short and long-term government borrowing.

On the part of the Czech National Bank, inflation is perceived as a quantity that is influenced by external and internal factors in a small open economy. However, these individual determinants may change over time depending on the current economic developments. It means inflation can be determined in different periods, with different values.

As external determinants, which can influence inflation in the Czech Republic and form the assumptions of the inflation forecast, the euro area GDP indicator, euro area industrial producer price indicator, consumer price index in the euro area, interest rates such as Pribor and Brent crude oil spot price. In addition, inflation may be affected by sudden foreign supply or demand shocks or economic crises, which are to some extent reflected in the Czech Republic. Bekana (2016) assesses short and long-term determinants of inflation in post-communist countries. Empirical observation is based on the example of Ethiopia. The model compiled by this author determines the inflation determinants of both the supply and demand side of the market. World market prices, domestic currency rates, inflation expectations, money supply, gross domestic product, government debt and real interest rates are defined. As an explained variable, inflation is derived from the harmonized consumer price index in this model. The econometric analysis was performed on annual data with a parameter capture from 1979 to 2013 using least squares methods. Based on the tests, it was found that in the post-communist economy the long-term determinants of inflation are the exchange rate, gross domestic product, world price index, interest rates, expected inflation and government debt.

Many authors of empirical work include the development of money supply into their econometric models. The positive impact of monetary aggregate developments on inflation is shown, for example, in the study written by Grauwe and Polan (2005). In their research they used the data from International Financial Statistic for money supply M1 and M2 where this impact is confirmed on a sample of 160 countries over a parameter capture of thirty years, from year 1969 until 1999. They found out that the results show a positive relationship between money supply and inflation rate. The correlation between M1 and inflation is 0, 877 where, the

correlation between M2 and inflation is 0, 89. Shelley and Wallace (2005) have a same viewpoint as Grauwe and Polan (2005). These authors also agreed that inflation rate and money supply have a positive relationship with each other. In their research they found out that these variables have a high correlation mainly in long term between 8 and 10 years. The importance of monetary aggregate developments in overall inflation was also confirmed in the work carried out by Paun and Topan (2013) on the example of Romania. The significant impact of M2 on inflation was confirmed on the basis of monthly data from 1997 to 2010. A research done by Armesh et al (2010) found out that money supply has also positive relationship on inflation. Authors used ordinary least squares (OLS) to identify this relationship. They used annual time series data from 1961 until 2005. Based on OLS estimation, the results proved that there is a positive relationship between inflation rate and money supply in a long run in Iran.

The study by Choueiri, Ohnsorge and Elkan (2008) for the International Monetary Fund used the GDFM to estimate the common-origin component of inflation in the 25 EU countries including the Czech Republic. The GDFM is a generalization of dynamic factor models (DFMs) that were first applied to macroeconomic data in the late 1970s, but which required strong restrictions on the correlations among the variables. For the Czech Republic and Slovakia, the rate of external shocks is assessed even as extremely low. Specific inflation criteria are divided into several categories. The first regression is based on economic factors that are defined by the labour market, the exchange rate and the relative level of prices to the European Union average. Into the second category, variables corresponding to the institutional environment are added. The results of the analysis show that the most important internal determinant of inflation is the exchange rate that demonstrably affects the rise in inflation, with a more pronounced depreciation than the EU average.

Babetská-Kucharčuková (2007) finds that the transmission channel is very important for the small open economy of the Czech Republic, where more than 90% of all contracts on imported goods are denominated in foreign currency, mainly in euros. In addition to the transmission channel, other macroeconomic variables, such as the nominal effective exchange rate, the three-month Pribor interest rate, wage costs, GDP and the euro area HCPI, are included in the model based on the VAR model. The survey was conducted on both non-tradable and tradable goods. Based on the analysis, it was found that the change in the exchange rate had the biggest impact on the CPI, namely after six months. However, this effect is mainly reflected in tradable goods and services, while in the non-tradable sector, the effect of the exchange rate on price developments is negligible.

Bitans (2004) attempts to test the influence of the real effective exchange rate on inflation, but adds further macroeconomic variables to the VAR model. The research is conducted in 13 countries of Eastern Europe, including the Czech Republic, from 1993 to 2003. The selected variables are the output gap, the exchange rate, the industrial production index, the monetary aggregate and the interest rates.

Murshed and Nakibullah (2015) highlight that for exploring the long time period in the open economy is necessary to incorporate also external factors not only domestic into the research. For example inflation rate in countries which are main trading partners. The research is conducted for GCC (Gulf Cooperation Council) countries for period 1975-2011.

Oikawa and Ueda (2018) emphasise the relationship between inflation rate and economic growth. Also in this case is really important to know which factors influence the inflation rate because of right setting of inflation target by the central bank. Central banks, by setting a proper inflation target, can stimulate or directly support the country's economic growth. The study shows that the optimal inflation rate stimulates economic growth and that deviation from the optimal level of inflation rate has significant negative impacts.

Based on an overview of empirical work on the determinants of inflation, it is clear that although it is possible to agree on some factors of inflation that are combined from a theoretical point of view, it is always necessary to take into account the specifics of the economy under consideration.

### 3 METHODOLOGY

Particular form of the model is described in this section. Also, assumption of model is summed up in this section. This chapter also includes data description.

#### 3.1 Variables

Variables are described in this section.

The dependent variable *Inflation rate (+) (HICP\_CZ)* is the variable  $HICP\_CZ_t$  which represents inflation rate in the Czech economy in this model of regression analysis. There are more options, how to measure inflation rate. In this paper, index called HICP (harmonized consumer price index) is used to measure inflation in the Czech Republic and in Germany as well. Data were obtained from Eurostat database.

Independent variables include external and also internal variable that can influence inflation rate in the Czech economy. Every variable which has been chosen for the model is based on economic theory.

The first one is *Inflation rate in the German economy. Inflation rate in the German economy (+) (HICP\_GER)* is also measured as a harmonized consumer price index HICP. Data were also obtained from Eurostat database. This variable represents an external variable. Germany is the main trade partner of the Czech Republic. Czech economy as a compact yet widely open economy extensively orbits the German economy. These are the primary reasons why has been this variable chosen into this model. Higher value of this variable should cause rising of inflation rate in the Czech economy. The next one is *Real Effective exchange Rate (-). (REER)* is one of the main indicators of the country's international competitiveness. Higher values of this variable should cause decreasing of inflation rate. Data were obtained from Eurostat database and CNB database, called ARAD. *The unemployment rate (U)* in the Czech Republic, as well as in any other advanced economy, copies the state of the economy. Based on the Phillips curve, lower values of unemployment should cause rising of inflation rate. Expected sign is (-). The next variable called *Monetary aggregate (+) (M2)* according to the CNB (2018) includes cash currency, overnight deposits that can be immediately converted into cash or used for non-cash transactions, deposits with a maturity of up to 2 years and deposits redeemable at notice of up to 3 months. According to monetarist theory, the most important factor in influencing inflation is the amount of money in the economy.

The gross domestic product (GDP) is most commonly used as an indicator of the output of the economy. However, this indicator is only monitored quarterly, which is why it will be replaced by a substitutable *index of industrial production*. Eurostat (*IPP*) Index (2018) measures the output of industries, which is measured by output revenue and cleared from price effects, is converted to a fixed period of the reference year selected. *The industrial production index (+)* is compiled from data from sectors including mining and quarrying, manufacturing, electricity generation, distribution, heat and air conditioning. *The oil spot price* was chosen as the next variable. Fred (2018) *the oil price (+) (BRENT)* is one of the world's leading commodities that can significantly affect its economic aggregates. For many economic subjects, petroleum, or derivatives; petrol or diesel, is the input cost. Growth in oil prices may increase production, marginal consumption and, therefore, the cost of output products. Oil is imported commodity.



The oil price represents an external factor in a defined econometric model. Next variable which definitely influence inflation rate in porous economy is *Import prices*. The price index is selected as another external determinant of inflation. *Import prices (+) (IP)* serve as an input factor for many companies. If there is an increase in import prices, it is to be assumed that the final output will also rise. The CNB (2018) states that the index is compiled from import prices, which are converted to the Czech currency using the current exchange rate. The prices of imported goods are surveyed by the Czech Statistical Office from a sample of 580 economic subjects. The last variable which was chosen by economy theory is *Interest rate*. *Interest rate (-) Pribor (PRIBOR)* is the interbank rate for which commercial banks lend on the Czech interbank market. This rate is set by the Czech National Bank in the Czech Republic and is based on the Eurostat reference methodology (2018) on the reference money market rate for short-term financial market interest rates.

Because of the economy theory and better results which came with delay, were variables *U* which represents the unemployment and variable *IPP* which represents the industrial production lagged up to 12 periods.

### 3.2 Methods

A particular form of the model is described in this section.

Linear regression is a basic and commonly used type of predictive analysis. The overall idea of regression is to examine two questions. Will a set of predictor variables deliver good data in predicting an outcome (dependent) variable? Which variables in particular are significant predictors of the outcome variable, and in what way do they, indicated by the magnitude and sign of the beta estimates—impact the outcome variable? These regression estimates are used to explain the relationship between one dependent variable and one or more independent variables.

#### Regression model

$$HICP\_CZ_t = \beta_1 + \beta_2 \cdot HICP\_GER_t + \beta_3 \cdot REER_t + \beta_4 \cdot U_t + \beta_5 M2_t + \beta_6 \cdot IP_t + \beta_7 \cdot IPP_t + \beta_8 \cdot BRENT_t + \beta_9 \cdot PRIBOR_t + \mu_t. \quad (1)$$

HAC estimator is used in this model. The Newey–West estimator is used in statistics and econometrics to provide an estimate of the covariance matrix of the parameters of a regression-type model when this model is applied in situations where the standard assumptions of regression analysis do not apply. The estimator is used to try to overcome autocorrelation (also called serial correlation), and heteroscedasticity in the error terms in the models, often for regressions applied to time series data.

### 3.3 Data

Data sources are mentioned in this section. The data was processed based on the Eviews regression analysis. Data were obtained from the ARAD and Eurostat databases. Data were obtained as seasonally adjusted, with a monthly frequency for the period from February 2001 to December 2017. The scope of research has been assembled and based on availability of data. First difference was used.

Tab. 1 – Data description. Source: own research

Variable names	Variables	Description	Source
Inflation rate in the Czech Republic	<i>HICP_CZ</i>	Monthly change of inflation rate measured by HICP index.	Eurostat
Inflation rate in Germany	<i>HICP_GER</i>	Monthly change of inflation rate measured by HICP index.	Eurostat
Import prices	<i>IP</i>	Monthly change in mil. CZK	Eurostat
Index of industrial production	<i>IPP (-12)</i>	Monthly change of IPP index in p.p.	Eurostat
Interest rate	<i>PRIBOR</i>	Monthly change of interest rate in p.p.	ARAD
The oil price	<i>BRENT</i>	Monthly change of oil prices in \$	Eurostat
Unemployment	<i>U (-12)</i>	Monthly change of unemployment (%)	Eurostat
Real Effective exchange Rate	<i>REER</i>	Monthly change of unit label cost index in p.p.	ARAD
Monetary aggregate	<i>M2</i>	Monthly change in CZK (year to year)	ARAD

#### 4 RESULTS AND DISCUSSION

Results are expressed in this section. Firstly, there are some theoretical econometric assumptions as a stationarity, multicollinearity etc. Then there are results of estimated model.

Before the individual results of the model can be interpreted, it is necessary to perform econometric verification of the model in order to meet the basic conditions of residue development. Tests for data stationarity were performed using a Kwiatkowski–Phillips–Schmidt–Shin (KPSS) test that evaluated all variables as stationary. In addition, multicollinearity was investigated, which in no case exceeded the threshold of 0.8, and therefore no dependence that could affect the model's results was found between the variables.

Tab. 2 – Results of the regression analysis. Source: own research

Variables	Coefficient	Std. Error	t-Statistic	Prob.
$\Delta HICP\_GER+$	0,2124 *	0,1222	1,7379	0,0838
$\Delta IP+$	0,2172 ***	0,0374	5,8080	0,0000
$\Delta IPP(-12)+$	0,0150	0,0151	1,2777	0,2029
$\Delta PRIBOR-$	-0,1408	0,1692	-0,8323	0,4063
$\Delta BRENT+$	0,0057	0,0048	-1,1972	0,2326
$\Delta U(-12)-$	-0,1824	0,1181	-1,5443	0,1242
$\Delta REER+$	0,1737***	0,0431	4,0265	0,0001
$\Delta M2+$	1,8762***	0,5730	3,2745	0,0013

Note: HICP\_CZ dependent variable, OLS method with HAC Standard Errors is used, \*\*\* the 1% of significance, \*\* the 5% level of significance, \* the 10 % level of significance, 203 observation, R-squared 40 %, Adjusted R-squared 37%.

The results of the model in Table 2 show that change in inflation rate in the Czech Republic is influenced by the variables that present change in inflation rate in Germany, followed by change in the import prices, change in the real effective exchange rate and change in the monetary

aggregate M2. The results are in the line with economic theory except for change in the real effective exchange rate. Based on the results of the regression analysis, a positive change in the real effective exchange rate against the change in inflation was found. With real strengthening, inflation is also rising. However, this result does not correspond to the image of the Czech National Bank, which intentionally weakened the Czech crown against the euro to reach higher inflation since November 2013. This dependence on weakening the currency against both the euro and any other currency may work for a short time, but in the long run that is captured in the analysis, many other macroeconomic changes can affect the development of these variables. For example, the Czech economy commenced the transformation into a market economy since the 1990s. This significant change has contributed to a significant engagement in international trade and a gradual convergence to advanced market economies. This economic development was also reflected in the strengthening of the real effective exchange rate until 2011. Since 2011, the real effective exchange rate has started to show a downward trend, which means that the economy is more competitive abroad, gaining export advantage. The calculation of the real effective exchange rate of the Czech crown also includes the price levels of the Czech Republic and abroad. Therefore, when estimating this parameter, it does not only depend on the exchange rate, but the indicator speaks about the competitiveness of the economy as a whole.

The Czech Republic, as a compact open economy, is certainly influenced by the inflationary development of the neighbouring country Germany, with which it also leads a large part of its foreign trade, both from import and export, and fluctuations in the import prices have therefore also been another important variable. From economic theory, it is also known that the exchange rates are one of the main factors that unconditionally influence the inflation rate. The last variable, which was then statistically significant, is change in the monetary aggregate M2. The results show that change in inflation rate in the Czech economy is mainly influenced by the internal factors as a monetary aggregate etc. and then external factors as inflation rate in Germany etc. After statistical verification, explanatory variables were found to be statistically significant at the 1% level of significance for change in the M2, change in the import price index and change in the real effective exchange rate, and the 10% level of significance for the variable representing change in German inflation rate. From R-squared, it is clear that by means of the 4 chosen inflation determinants the endogenous quantity can be explained from 40%.

Variables that were recorded in the model as insignificant are unemployment, the oil price, index of industrial production and interest rate Pribor. For example the prediction for unemployment was the validity of the Phillips curve. This research did not confirm statistically significant relationship between inflation rate and unemployment. In many researches is shown that this functional relationship is valid only in a short period. The Czech National Bank is characterized by a strong degree of independence from political influences, when this fact can separate fiscal and monetary interests. For example for this reason, it is possible that in the Czech Republic conditions Phillips curve may not apply. Next insignificant variable is index of industrial production. The gross domestic product is most commonly used as an indicator of the output of the economy. However, this indicator is only monitored quarterly, which is why it was replaced by a substitutable index of industrial production. Maybe because of this change is IPP not significant in this case. Next variable presents external factor- the oil price. The oil price is one of the world's leading commodities that can significantly affect its economic aggregates. But it is an imported commodity and import prices were found as a statistically significant, maybe also oil price is presented by this way and separately has no big influence on inflation rate in the Czech Republic because no major fluctuations in oil prices are recorded in the period under review. The last variable is interest rate Pribor which is a short term rate. This research includes long period of 17 years so in that way is possible that short term rate can be find as a statistically insignificant.

## 5 CONCLUSION

According to the quantity theory of money, money plays an important role in the economy. Nobel laureate in economics Milton Friedman said that excess supply of money in an economy leads to domestic inflation. The regression analysis confirms the proportional impact of change in the monetary aggregate M2 in the economy on change in inflation rate. This variable is even presented in the model as one that most influences the development of change in inflation in the Czech Republic over the reference period, most of all explanatory variables. Changes in German inflation, which is presented in the model through the HICP index, also has a significant influence on the observed explanatory variable. It is clear that under the conditions of the Czech economy, whose largest trading partner is Germany. The development of German macroeconomic variables will also flow into Czech economic indicators. Another important external factor included in the model is change in the import price index. The compact and porous economy will always depend on trade with international business partners. If prices of imported goods rise, these goods will be sold in the domestic Czech market, this will be reflected through rising price level. The final change occurs in the real effective exchange rate.

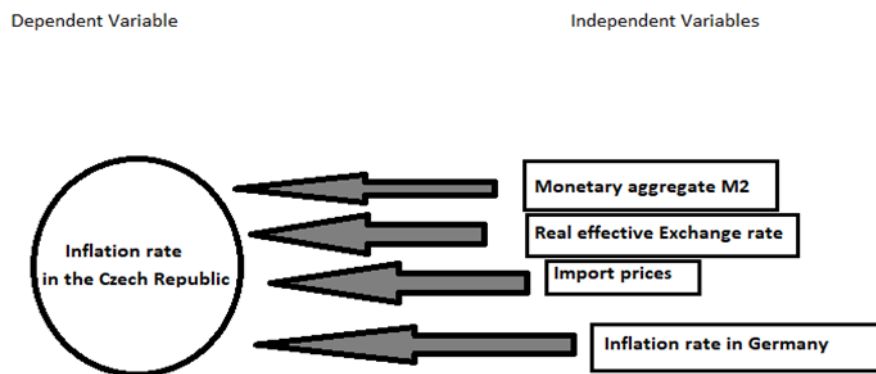

Fig. 1 – Factors influencing inflation in the Czech Republic. Source: own research

On the basis of the research carried out, economic determinants of inflation were found and analysed, which contributed to the development of Czech inflation from 40% by R-squared. It is clear that all factors of inflation have not been included in the model due to several causes. Nevertheless, change in inflation rate was explained by 40%. An unexplained portion of inflation will also reflect psychological changes in company behaviour that are affected by specific factors at each time and country. These factors can't be fully interpreted and qualified. For this reason, it is important that the Czech National Bank, as an independent institution not subject to political influences, develop inflation as closely as possible and predicted to achieve price stability.

Knowledge of the basic determinants of inflation rate according to the theoretical framework is the basis for further detailed research in this area. This research serves primarily as material for other research that may be related to deflation, or more specifically, to the investigation of the determinants of inflation. Further researches may be based, for example, on the examination of property inflation and the issuance of mortgages. The problem with this type of inflation is that liquidity is not there when comparative prices are downward. The second problem is that mortgages and the composite value are on bank's balance sheets as "assets". In reality they might actually be a liability. Or this research can also serve as a material for very controversial theme in financial economy- Carry trade. It allows a corporate or private equity player to borrow capital cheaply in one market and use it in another. It causes distortions and inflation in assets and asset classes. It means that central banks have a very big problem to regulate or control inflationary effects in this case. In addition, this research can serve for further research on

deflation because in recent years, deflation rather than inflation has been a macroeconomic threat mainly in the European Union and also in the Czech Republic. So these themes mentioned above could be used for further researches.

### Acknowledgements

The author gratefully acknowledges financial support from the VŠB–Technical University SGS grant project No. SP2019/119 (Econometric Modelling of Fiscal, Monetary and Financial Aspects of the European Economies).

### References

- Armash, H., Salarzahi, H., Mohammad Yaghoobi, N., & Heydari, A. (2010). Causes of inflation in the Iranian economy. *International Review of Business Research Papers*, 6(3), 30-34. Retrieved from [https://www.researchgate.net/publication/229053633\\_Causes\\_of\\_Inflation\\_in\\_the\\_Iranian\\_Economy](https://www.researchgate.net/publication/229053633_Causes_of_Inflation_in_the_Iranian_Economy)
- Babecká-Kucharčuková, O. (2007). Transmission of exchange rate shocks into domestic inflation: The case of the Czech Republic. *Czech Journal of Economics and Finance*, 59(2), 137-152. Retrieved from [http://journal.fsv.cuni.cz/storage/1155\\_1155\\_babecka.pdf](http://journal.fsv.cuni.cz/storage/1155_1155_babecka.pdf)
- Bekana, D. M. (2016). What Causes Inflation in a Post-Communist Economy? Evidence from Ethiopia. *The Romanian Economic Journal*, 61, 3-46. Retrieved from <http://www.rejournal.eu/article/what-causes-inflation-post-communist-economy-evidence-ethiopia>
- Bitans, M. (2004). *Pass-Through of Exchange Rates to Domestic Prices in East European Countries and the Role of Economic Environment*. Retrieved from [https://www.bank.lv/public\\_files/images/img\\_lb/izdevumi/english/citas/Pass-Trough\\_Exchange\\_Rates.pdf](https://www.bank.lv/public_files/images/img_lb/izdevumi/english/citas/Pass-Trough_Exchange_Rates.pdf)
- Choueiri, N., Ohnsorge, F., & van Elkan, R. (2008). *Inflation Differentials in the EU: A Common (Factors) Approach with Implications for EU8 Euro Adoption Prospects*. Retrieved from [https://papers.ssrn.com/sol3/papers.cfm?abstract\\_id=1089687](https://papers.ssrn.com/sol3/papers.cfm?abstract_id=1089687)
- CNB, (2018a). *ARAD - Time series data*. Retrieved from [https://www.cnb.cz/cnb/STAT.ARADY\\_PKG.SEStAVY\\_DZDROJE?p\\_zdrojid=IRUNO&p\\_lang=CS](https://www.cnb.cz/cnb/STAT.ARADY_PKG.SEStAVY_DZDROJE?p_zdrojid=IRUNO&p_lang=CS)
- CNB, (2018b). *ARAD - Unemployment*. Retrieved from [https://www.cnb.cz/cnb/STAT.ARADY\\_PKG.STROM\\_DRILL?p\\_strid=ACH&p\\_lang=CS](https://www.cnb.cz/cnb/STAT.ARADY_PKG.STROM_DRILL?p_strid=ACH&p_lang=CS)
- CNB, (2019). *Inflation targeting*. Retrieved from <https://www.cnb.cz/en/monetary-policy/inflation-targeting/>
- Dellas, H., Gibson, H., Hall, S., & Tavlas, G. (2018). The macroeconomic and fiscal implications of inflation forecast errors. *International Review of Economics and Finance*, 93(1), 203-217. doi: 10.1016/j.jedc.2018.01.030
- Eurostat, (2018a). *Effective exchange rates- monthly data*. Retrieved from [http://appsso.eurostat.ec.europa.eu/nui/show.do?dataset=ert\\_eff\\_ic\\_m&lang=en](http://appsso.eurostat.ec.europa.eu/nui/show.do?dataset=ert_eff_ic_m&lang=en)

- Eurostat, (2018b). *HICP monthly data Czech Republic*. Retrieved from [https://ec.europa.eu/eurostat/web/hicp/data/database?p\\_p\\_id=NavTreeportletprod\\_WAR\\_NavTreeportletprod\\_INSTANCE\\_BO6Fgp25CkI9&p\\_p\\_lifecycle=0&p\\_p\\_state=normal&p\\_p\\_mode=view&p\\_p\\_col\\_id=column-2&p\\_p\\_col\\_count=3](https://ec.europa.eu/eurostat/web/hicp/data/database?p_p_id=NavTreeportletprod_WAR_NavTreeportletprod_INSTANCE_BO6Fgp25CkI9&p_p_lifecycle=0&p_p_state=normal&p_p_mode=view&p_p_col_id=column-2&p_p_col_count=3)
- Eurostat, (2018c). *HICP monthly data Germany*. Retrieved from [https://ec.europa.eu/eurostat/web/hicp/data/database?p\\_p\\_id=NavTreeportletprod\\_WAR\\_NavTreeportletprod\\_INSTANCE\\_BO6Fgp25CkI9&p\\_p\\_lifecycle=0&p\\_p\\_state=normal&p\\_p\\_mode=view&p\\_p\\_col\\_id=column-2&p\\_p\\_col\\_count=3](https://ec.europa.eu/eurostat/web/hicp/data/database?p_p_id=NavTreeportletprod_WAR_NavTreeportletprod_INSTANCE_BO6Fgp25CkI9&p_p_lifecycle=0&p_p_state=normal&p_p_mode=view&p_p_col_id=column-2&p_p_col_count=3)
- Eurostat, (2018d). *Production in industry - monthly data*. Retrieved from [http://appsso.eurostat.ec.europa.eu/nui/show.do?dataset=sts\\_inpr\\_m&lang=en](http://appsso.eurostat.ec.europa.eu/nui/show.do?dataset=sts_inpr_m&lang=en)
- FRED, (2018). *Crude oil prices*. Retrieved from <https://fred.stlouisfed.org/series/DCOILBRENTTEU#0>
- Grauwe, P.D., & Polan, M. (2005). Is inflation always and everywhere a monetary phenomenon? *Scandinavian Journal of Economics*, 107(2), 239-259. doi: 10.1111/j.1467-9442.2005.00406.x
- Hančlová, J., (2012). *Ekonometrické modelování: klasické přístupy s aplikacemi*. Prague: Professional Publishing.
- Murshed, H., & Nakibullah, A. (2015). Price level and inflation in the GCC countries. *International Review of Economics and Finance*, 39(1), 239-252. doi: 10.1016/j.iref.2015.04.008
- Oikawa, K., & Ueda, K. (2018). The optimal inflation rate under Schumpeterian growth. *International Review of Economics and Finance*, 100(1), 114-125. doi: 10.1016/j.jmoneco.2018.07.012
- Păun, C., & Topan, V. (2013). The monetary causes of inflation in Romania. *Romanian Journal of Economic Forecasting*, 16(1), 5-23. Retrieved from [http://www.ipe.ro/rjef/rjef1\\_13/rjef1\\_2013p5-23.pdf](http://www.ipe.ro/rjef/rjef1_13/rjef1_2013p5-23.pdf)
- Shelly, G., Wallace, F. (2005). The relation between U.S. money growth and inflation: Evidence from a band-pass filter. *Economics Bulletin*, 5(8), 1-13. Retrieved from <http://www.economicsbulletin.com/2005/volume5/EB-05E30001A.pdf>

## Contact information

**Ing. Sára Novorytová**

VSB – Technical University of Ostrava, Faculty of Economics

Sokolská 33, 70200, Ostrava, Czech Republic

E-mail: sara.novorytova@vsb.cz

ORCID: 0000-0002-1807-6885

doi: 10.7441/dokbat.2019.079

## Appendix number 1: Seasonally adjusted data

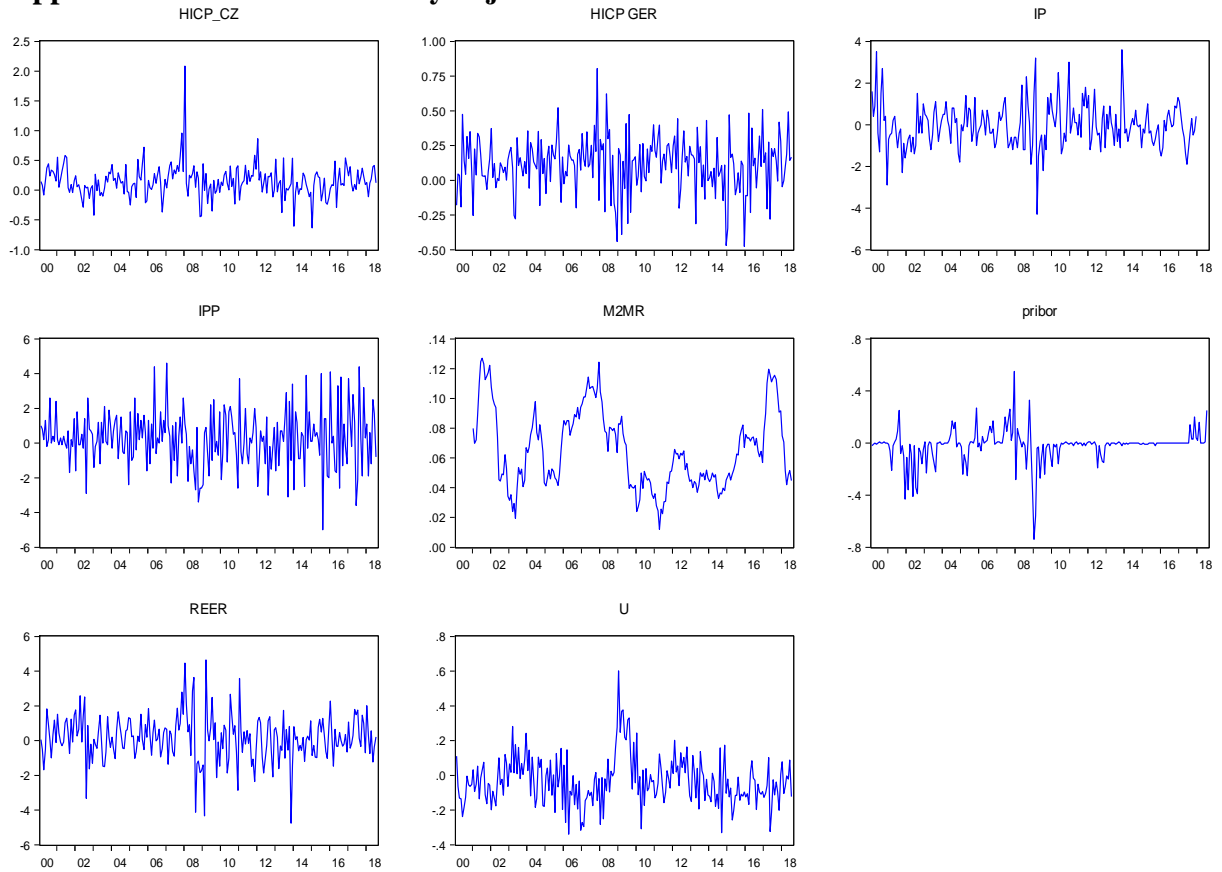

# DIGITAL TRANSFORMATION OR INFORMATION MANAGEMENT: WHAT DIRECTION ARE COMPANIES GOING IN?

*Fortune Nwaiwu, Ladislav Buřita*

## **Abstract**

The research assessed Digital Transformation and Information Management with a view to determine between both, what preferences the contemporary company is exploring in the era of the digital economy. Information Management is a traditional discipline that is responsible for the preparation and distribution of information; it is connected with a company's information strategy (InS) and information systems (IS), while Digital Transformation is an emerging subject area that explores organisational transformation through the incorporation of digital technologies into organisational processes and reinvention of business models to improve a company's market competitiveness. A mixed method approach is adopted for the research, it involved quantitative and qualitative methods was adopted for the research. Data for the quantitative research was gathered through an online questionnaire; it covered respondents from 60 companies spread across 17 different countries. About 70% of companies implemented some form of InS, while about 80% of organizations had more than one type of information systems implemented within their business processes. From the ICT point of view, more than 50% of companies implemented the following: document management systems, business intelligence, cloud computing, and social media. The qualitative research involved in depth interviews with top management staff from the five companies covered in the survey. The respondents were of the opinion that the relationship between IM and DT within their organization was a priority for strategic planning and future growth. The survey results also showed that some respondents considered DT a sub-function of InS. Three maturity levels of the company and organization in relations to DT and InS were also suggested as follows from the analysis: the basic (37%), middle (26%), and high (37%) level. The paper concludes with an evaluation of the working hypothesis.

*Keywords: information management, digital transformation, information strategy, ICT, quantitative and qualitative research*

## **1 INTRODUCTION**

The Information Management (IM) and Digital Transformation (DT) are two subject areas of strategic importance to a company which could translate to significant value if properly harnessed. They both elicit a lot of interest from academics and industry practitioners who seek to adequately leverage them for their inherent benefits to industry. Information Management is traditionally a subject with significant footprints in industry. Information management (IM) is a broad conceptual term that has various meanings and interpretations among different constituencies. Often the term is used interchangeably with others. However, Information management generally covers how information is created, acquired, organized, stored, distributed, and used as a means of promoting, efficient and effective information access, processing, and use by people and organizations (Detlor, 2010), the terminology is also often used interchangeably with Information Systems (IS), Management Information Systems (MIS) and Information and Communication Technologies (ICT).

On the other hand, Digital Transformation relatively maintains the status of an emerging subject among industry practitioners, government policy makers and academic researchers. According



to Riedl et al. (2017), Digital Transformation is the process of introducing digital technologies into internal processes to effect changes that lead to organizational transformation. However, it is pertinent to state that Digital Transformation is a subject that is still shrouded in a lot of conceptual obfuscation hence making it difficult to establish harmony in terms of how it is defined and interpretation by different groups of stakeholders. It is pertinent to state that Digital Transformation requires an enterprise mind-set and impacts every function and business unit of an organization (Carcary, Doherty & Conway, 2016).

Empirical evidence suggests that Information Management and Digital Transformation may not necessarily not operate in isolation of each other, hence the need for one not to be ignored in favour of the other especially in an era of hypercompetitive business environments wherein organizations are in desperate need for sustainable growth through improvements in process efficiencies and cost reduction, that ultimately translates to overall improvements in a company's overall market competitiveness. Within the context of the digital economy, Carcary et al. (2016) argues that "Digital Transformation needs to become central to how businesses operate, and that organizations need to effectively to re-think and possibly re-invent their business models, so that they continually learn from interactions with customers, suppliers, and partners in the business ecosystem in order to remain competitive". This must be done without losing the benefits of Information Management to the company or organization.

Hence, this research aims to assess what works best for a company or organization in the fast paced competitive environment in which they operate in today. This will be done with a view to gain a better understanding what strategic path companies are following in terms of technology adoption and implementation within their operations. The research will address the following research questions: Are companies disposed to explore digital transformation or do they prefer to remain conservative by retaining traditional Information Management systems? How is Digital Transformation influencing the traditional roles and tools of Information Management in companies today? And finally, what are the emerging business models in companies that are dependent on digital technologies? The research adopts a mixed method approach that combines both qualitative and quantitative research methodologies. The paper concludes by contributing meaningfully to the body of knowledge on IS as it relates to the traditional field of IM and the emerging field of DT. It also brings to the fore other important areas that deserve more thorough investigation in future research.

## **2 LITERATURE REVIEW**

### **2.1 Information Management**

Information Management as applied in informatics and management, encompasses the whole spectrum of information activities within a company. It focuses on tasks such as the acquisition, processing, reporting and distribution of information within an organization (Afifi & Weiner, 2004; Riedl et al., 2017; Robertson, 2005). The primary objective of Information Management is the provision of the quickest and the best support for workers of a company or an organization, with the information required to improve internal and external processes of the company or organization. Hence, Information Management covers the following segments of management functions: planning, management, administration, and control; and for working with data and information: acquisition, storing, retrieval, processing, and distribution. Information activities do not only cover the preparation of information, it also extends to the preparation of information systems (IS) and knowledge resources, to support the information work requirements of the organization.

Also, Robertson (2005) views “Information Management as an umbrella term” that involves all systems and processes within the company and organization, that results in the creation, usage, and distribution of information. IM deals with people, processes, and technology. In addition, Wilson (2016) explains various aspects of Information Management such as source and connection with other disciplines; elements of Information Management; the economics of information; access to information, its privacy and security; Information Systems and education for IM. For Whittaker, Bellotti and Gwizdka (2006), Information Management involves the information processing and management functions that should deliver the right information to the right people in the right time. They also argue that Personal Information Management (PIM) is about the activities of people with as it concerns information processing in their various tasks and roles as organization or company employees; as members of communities or individuals. The views expressed are also similar to those of several other authors (Afifi & Weiner, 2004; Franklin, Halevy & Maier, 2005; Hicks, 2007; Mildeova & Brix, 2012; Mithas, Ramasubbu & Sambamurthy, 2011; Moen & Brennan, 2005).

## **2.2 Digital Transformation**

Within the business and academic community, the subject of Digital Transformation means different things to different stakeholders. However, there is a convergence of opinions as it relates to how digitalization through digital technologies is having a transformative effect on businesses and organizations. Digital technologies cover a broad range of electronic tools, systems, devices and resources that generate store or process data. They include social media, online games and applications, multimedia, productivity applications, cloud computing, interoperable systems and mobile devices. They enable the compression of immense amounts of information on small storage devices that can be easily preserved and transported. Digital technologies have significantly affected society by transforming how people communicate, learn, and work. Digitization is at the core of the entire process, in its most basic form, it is the conversion of analogue information into digital information (Ernst & Young, 2011). Digital transformation goes much more than that; it incorporates the whole gamut of digital technologies and organizational structures interacting in a continuously evolving manner. Clemons et.al. (2013) define Digital Transformation as “transformation precipitated by a transformational information technology.” While Bondar et al. (2017) define Digital Transformation “as a consistent networking of all economic sectors and as adaption of actors to new circumstances of the digital economy”.

The nature of such transformations could be as diverse as resulting in a significant change in business processes, organizational capabilities, operational routines, and entering new markets or exiting old markets (Ahlemann, 2016; Chen, Pan & Ouyang, 2014; Dehning et al., 2003; Orlikowski, 1996; Pan, Xianghua & Huang, 2009; Venkatraman, 1994). Digital Transformation is also incorporates the alignment of IT and organizational structures (Venkatraman, 1994). Beyond the nuanced approach to understanding Digital Transformation, Venkataraman (2015) takes a more direct view to defining digital transformation, he comments that “it is all about re-imagining certain aspects if not entire business processes, services and interactions with customers, partners and vendors by leveraging consumer oriented digital technologies to deliver superior experience.”

## **2.3 Relationship between Information Management and Digital Transformation**

Exploring the relationship between Information Management and Digital Transformation, Riedl et al. (2017) provides a summary that introduces conceptual clarity through three possible scenarios. Firstly, that Digital Transformation is a subset of Information Management; secondly, that Information Management and Digital Transformation are independent areas with

different underlying factors; and lastly, that Digital Transformation deals with topics related to strategic Information Management. He further argues that Digital Transformation comprises of tasks and methods that are already included in existing Information Management frameworks. He cited the example that 'strategic objectives' and 'tasks' are subsumed under the prefix 'digital', some of which have long been included in Information Management frameworks. However, i-Scoop (2016) explores the relationship between Information Management and Digital Transformation from a much more intertwined perspective; it is argued that Information Management is not just a key part of Digital Transformation. It also appears at each step along the journey towards achieving both specific and enterprise-wide Digital Transformation goals such as the improvement of customer experience through digital channels, improving operations, innovating or realizing competitive advantages. Thornley et al. (2016) from their research work on a knowledge management (KM) maturity model which is a component (critical capability) of the IT Capability Maturity Framework argue that the KM is 'fit for purpose' for organizations in the digital age.

Zimmermann et al. (2016) investigate Digital Transformation of business and IT, and it integrates fundamental mappings between adaptable digital enterprise architectures and service-oriented information systems. The Internet of Things, Enterprise Social Networks, Adaptive Case Management, Mobility systems, Analytics for Big Data, and Cloud services environments are emerging to support smart connected products and services and the Digital Transformation. Biological metaphors of living and adaptable ecosystems provide the logical foundation for self-optimizing and resilient run-time environments for intelligent business services and related distributed information systems with service-oriented enterprise architectures. We are investigating mechanisms for flexible adaptation and evolution for the next digital enterprise architecture systems in the context of the Digital Transformation.

## **2.4 Summary of Review**

Empirical evidence from the reviewed literatures supports the argument for a complex and changing dynamics in the relationship between Information Management and Digital Transformation. While traditional Information Management systems in organizations originally focused their coverage to traditional information systems or core information technology for operational purposes, the need to review their relevance from a broader perspective to cover Digital Transformation related technology trends such as Internet of Things (IoT), Big Data and Data analytics, Cloud based services, Digital Platforms, Enterprise Social Networks, etc.

As these technology innovations become ubiquitous thereby leading to enterprise-wide adoption, they bring unique value to the business which manifests in more efficient processes, reduced operational expenses and in turn better customer engagement which leads to higher customer satisfaction and retention rates. Regarding the interaction between Information Management and Digital Transformation, the literatures reviewed also reveal that for a successful Digital Transformation in any business organization which does takes full advantage of existing Information Management systems and processes and builds upon them, digital maturity and a modern organization culture are indispensable and important. Three key areas that may not be ignored: (1) Customer Demands - this is primarily about the provision of top-notch and delightful experience in every aspect of engagement and delivery of products or services; (2) Process Orientation - this should focus on digitization of processes within the company and employee enablement that ensures data-driven decision-making, which should ultimately result in greater performance improvement and overall operational transparency; and (3) Innovation in Business - this should lead to the development of new digital products or services, it could also be about digitizing existing business models and should go beyond

existing business needs with the aim of developing new innovative products and services that would cater to changing business needs.

However, the literatures reviewed also indicate three possible scenarios that define the relationship between Information Management and Digital Transformation within the organization (Riedl et al., 2017). It is easy and straightforward to understand the practical significance of Information Management or Digital Transformation as a standalone subject matter, but when viewed from the perspectives of these scenarios, it becomes challenging to juxtapose the academic understanding of the possible scenarios of relationships between Information Management and Digital Transformation with the practical applications. The first scenario, which treats Digital Transformation as a subset of Information Management, has the risk of ignoring the importance of Digital Transformation as a tool for complete transformation of an organization, with the implication of adopting a technological perspective and thereby limiting the immense potentials of Digital Transformation in reinventing the organization. The second scenario, which treats Information Management and Digital Transformation as distinctive and independent areas may lead to confusion and misunderstanding of how to harness the potential of each in creating a more efficient organization. The final scenario, which seems the most practical approach in viewing their relationship takes into consideration the overlaps in roles of both Information Management and Digital Transformation thereby making it easier to interpret both of them as being interrelated and interdependent (i-Scoop, 2016).

### **3 METHODOLOGY**

The research adopted a mixed method approach, it combined both qualitative and quantitative methods in its analysis. The qualitative aspect of the research involved a comprehensive review of relevant literatures that explored the subjects of Information Management and Digital Transformation within business and the academia, the objective was to establish evidence from previous research that analyses and investigates how information management and digital transformation interact within a company. It also involved expert interviews with high-level stakeholders within industry. Peer reviewed journals articles covering the subject areas of interest were identified and sourced from scientific database such as Google Scholar, Scopus, and Web of Science, the search term employed in querying these databases were keywords relating to “Information Management”, “Information Systems Management”, and “Digital Transformation”. The quantitative aspect of the research involved the collection of quantitative data through the use of an online questionnaire. A total of 60 respondents completed the survey questionnaire. Purposive sampling technique was employed in selecting the survey respondents, the primary criteria being that the respondents should fall within the top management cadre of their companies. Simple statistical analysis was conducted on the data collected from the survey, this was done with a view to analyse the state of adoption and implementation of different types of digital technologies within the companies covered by the survey, as this would give an insight into the emerging business models and direction of Digital Transformation within the companies.

The research was conducted in three stages. Stage one involved a review and analysis of evidence from literature that cover current trends in the subject areas of interest - Information Management and Digital Transformation. It investigated the status of Information Management viewed through the prism of a company’s Information Strategy and Information Systems. The status of Digital Transformation in companies covered by the research is analysed using the following indicators: Information Systems, Document Management System, Business Intelligence, Internet of Things, Enterprise Social Networks, Adaptive Case Management, Mobility access to IS, Analytics for Big Data, Cloud computing, in Memory Computing, etc.

Stage two involved the use of an online questionnaire for collecting data used in the quantitative aspect of the research; the major limitation of this part of the research was the difficulty encountered in obtaining sufficient amount of responses from a larger pool of respondents. Finally, stage three involved statistical analysis of data collected through the online questionnaire, the simple statistical analysis yielded results that provided the basis for the discussions and final recommendations of the paper.

## 4 EMPIRICAL RESULTS

The survey questions were divided into two parts, the first part captured the demographic data of respondents, while the second part captured data on information management and digital technology implementation and use cases within the companies covered in the survey. The section on demography had questions that captured company name, number of employees, and location of the respondent. The Information Management/Digital Transformation specific questions captured availability of Information Systems policy in organization, year of implementation of Information Systems policy (if available in organization), availability of standard information systems procedure in organization, how extensive is the level of information systems implementation in the organization, and if the information systems implemented in the organization are able to work efficiently together. The issues of adoption of digital technologies is investigated to enable the researchers understand the key organizational components that are impacted by these technologies, the specific types of digital technologies adopted, and the innovation use cases for which they were implemented.

### 4.1 Results of the quantitative research

The survey ran for a duration of 30 days, there were 60 respondents who completed the survey. The selection of respondents was on the professional profile and work experience, which had to be inclined to persons especially in managerial positions with extensive work experience in the ICT functions of their respective organizations. Survey respondents were spread across the globe as follows (the most important): Netherlands (14), Nigeria (14), United States of America (7), Germany (6), Canada (3), and Great Britain (3), 17 countries together. The survey covered companies ranging in size from small and medium scale enterprises (SMEs) to large corporations. The result from simple statistical data analysis indicated that about 70% of companies covered had some form of information strategy implemented, while those that had more IS within the organization that operated harmoniously across all segments of the organization were about 80%. This result shows that especially for smaller companies, there was not a stringent requirement to adopt a comprehensive Information Systems, this is generally attributable to the size of the organization and cost implications of having an elaborate strategy implementation regarding management of information systems within smaller organizations.

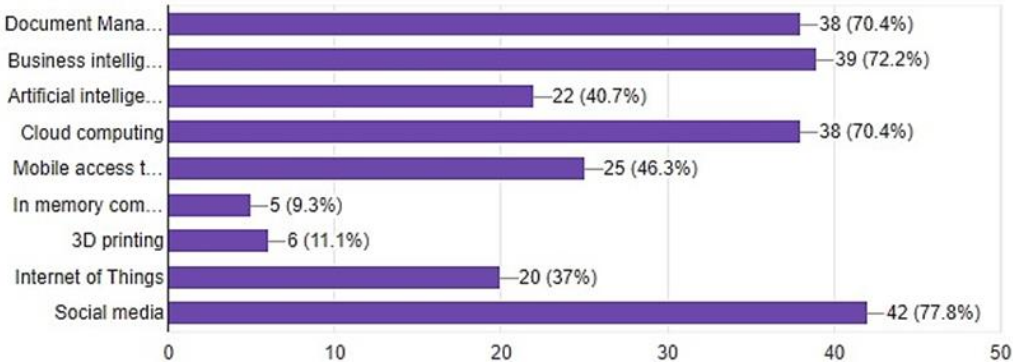

Fig. 1 – ICT adopted in DT by companies covered in survey. Source: own research

For standardized IS procedure, 64% of respondents acknowledged that their organizations had it implemented, and for IS working in harmony within the organization, about 54% acknowledged that their organizations had well functional systems, while 46% responded in the negative. In response to the question on adoption of digital technologies, 80% of respondents acknowledged that their organization had some form of DT adopted within their organization. The graphs in Fig. 1 and Fig. 2 indicate which of the DT were more widely adopted within the organizations covered in the survey and for what use cases they mainly cover. At the Fig. 1 is depicted the ICT adoption in DT and at the Fig. 2 is referred to the state of implementation of the new business method in era of DT.

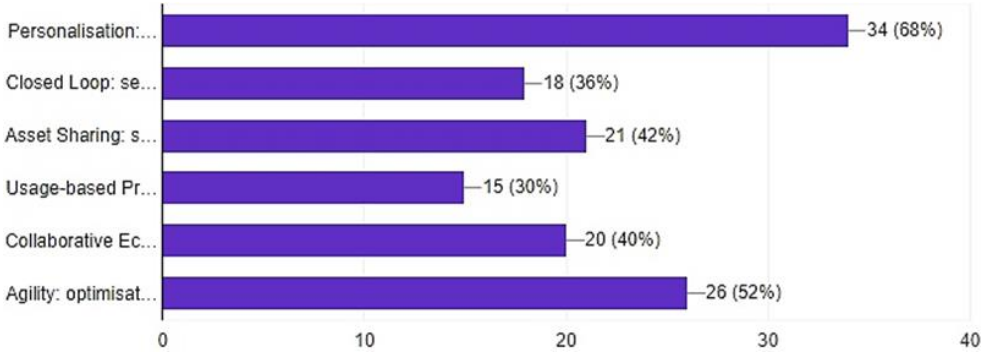

Fig. 2 – New business methods use cases at the companies. Source: own research

There are some patterns observed in the results of survey conducted. The first major observation is that there is a high adoption rate of DT within large multinational corporations and these DT is well integrated with their existing IS. It seems to suggest that they are able to attain a reasonable level of DT, which does not disrupt or negatively influence their existing information management systems. This is an indication of a well-structured information strategy policy for these large corporations. The second observation is that smallest companies that were captured in the survey lacked any clearly articulated Information Systems, this could be attributed to size of the companies and limited financial resources. While size does not make it so necessary for an elaborate information strategy policy, limited financial resources does on the other hand influence their ability to adopt IS such as CRM and ERP. However, they are able to leverage the benefits of DT such as cloud computing and social media, which play a vital role in reducing barriers to entry and improving their opportunities to reach new client base.

Among the list of DT most commonly adopted by companies covered in the survey, social media (SM), business intelligence (BI), document management systems (DMS), and cloud computing (CC) are the most adopted in that order; while the least adopted are in memory computing, 3D printing, and Internet of Things in that order as well. The high adoption rate of social media cuts across of company sizes. The reason can be seen from the perspective of its usefulness as a tool for customer engagement, advertising and building brand equity and managing company reputation. For Innovation Success Use Case, DT that enables a high degree of personalization and agility for the companies also see high adoption and applicability by companies covered in the survey. On the other hand, use cases that focused more on usage based pricing and closed loop saw the lowest levels of adoption and applicability. The use cases also represent the ability of the companies covered in the survey adoption to DT of the business processes, organizational structure and client engagement.

**4.2 Results of the qualitative research**

The qualitative research involved in depth interviews with top-level management staff from five of the companies covered in the survey. Staff selection for the interviews was based on

their within the companies. The objective was to contextualize the realities in these companies and achieve a deeper understanding of the quantitative analysis result from the survey. The identity of the interviewed staff is kept private for confidentiality purposes. The first respondent spoke about the relationship between IM and DT within their organization as a priority for strategic planning and future growth. He emphasized that the organization understood the rapid transformations of their industry segment by DTs and that management was actively pursuing strategies of implementation and adoption of DTs within the current framework of the company's operations to see how they can achieve sustainable growth and remain competitive.

The second respondent spoke in similar manner with the first, the major difference being that his own organization was more interested in application of ICT within the company in customer facing business processes especially because they operate within the financial services industry. He argued that it was more strategic in such capacity because of the peculiarities of their business operations, which is 'Services', based and required a level of unprecedented speed and need to maintain brand reputation at all times. The third respondent spoke about DT within her organization as a sub-function of the IS strategy. She stated that her company's management based this decision on the consideration that they were only applying technologies, which they considered ICT tools in the operations of the company and did not really see any business case for specialized adoption or justification for changing their current organizational processes.

The fourth respondent stated that his company saw the importance of ICT and was keen on reviewing operational processes with a view of integrating them into the business processes of the company. However, the management believed that it would be best to do it through a comprehensive review process that involves cross-departmental stakeholders to achieve their objectives without much disruption to already established processes. They were particularly more interested in harnessing the opportunities of cloud computing and data analysis because they considered both of more strategic importance to the operations of the company and their business interests. The last respondent spoke about the lack of interest in ICT by his company's management. He stated that management based the consideration on the size of the company and the belief by management that ICT would not offer any particular strategic advantage.

## **5 DISCUSSION AND CONCLUSION**

The Digital Transformation strategy observed in companies covered in the research, when related to the diagnosis of the future concepts of Industry 4.0, highlighted five maturity levels outlined as follows: the company has an existing information system for production management, its Internet presence is passive (website only), the company's management see a need for and contemplates process digitization, digitization in production, maintenance, product design, etc., it does not yet have a defined digital strategy, even though it has the partial ability to engage in information flows within its supplier-customer relationship; for the companies whose business model is driven by web interactivity and software enabled solutions begins to the potential of its business generated data, this has the potential to move them towards the path of setting up and implementing a digital strategy involving some level of automation of processes, and leading into information flows and integration of its supply-chain (linked digital code lists, interactive digital catalogues, semi-automatic orders); there is also the possibility of the companies taking advantage of multi-channel presence (web, mobile and tablet, social networks, etc.), this is usually a result of the company implementing a defined digital/information strategy, alongside the existence of data culture basics - data architecture projects, Managed Execution Systems, personalized products with virtual component within the company; also, with the company's integrated multi-channel presence in the digital world, company management ensures that digital/information strategy in the company is followed

through aggressively, for example by ensuring that the data architecture is integrated throughout the entire production chain from communication and data sharing to customer until after subcontractor, and use of digital diagnostics to predict failures and non-conformities in manufacturing, measuring and other systems; finally, the company is able to achieve digital transformation to a high degree when it is able to link the online and off-line operations into one fully integrated economic value adding system which enables it to offer unique personalized customer experience through virtual products/assistants, communicating with customers throughout the lifecycle of a partnership relationship, use of new and effective approaches (full automation, 3D printing, etc.), he realizes a cyber-physical system capable of individualized realization of any physical part of production, and by providing fully digitalized services to its partners and subcontractors thereby being able to control its production domain and achieving a high level of efficiency and significant cost reductions.

In line with the objectives of the research, and based on result of data analysis from survey questionnaire, the following maturity levels is proposed for companies in regards to how they approach Digital Transformation along with their established information strategy: Basic level – at this level, a company which currently does not have an information strategy starts to think about how to implement process digitization, the company has ICT implementation at a minimum or none existent and information systems support is low; Middle level – at this level of maturity, the company now has a defined information strategy which is essentially driven by its information systems, it has also been able to implement a significant amount of ICTs and digital technologies that puts it on a path of achieving digital transformation; High level – for companies at this level of maturity, they have been able to implement well defined and elaborate information strategy which is regularly updated in line with current technological trends to meet their business needs, all processes are digitized, and they have been able to implement a lot more ICTs and digital technologies thereby achieving the highest level of digital transformation.

The companies covered in the survey are grouped according to their level of Digital Transformation maturity level, and it is shown in Fig. 3 below. Even though the result of the analysis is limited because of total number of companies covered in the research, their size and locations, the result is important from a methodological point of view than from a focus on the result of the data analysis. Hence, it is proposed that further research should be conducted which would focus on gathering a more robust data set for analysis because the current research was severely resource constrained especially in the sense of timeframe for data gathering.

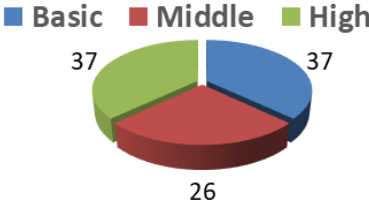

Fig. 3 – Maturity levels in DT of the companies. Source: own research

In this paper, we aimed to assess and analyse how the interaction between information management and digital transformation occurs within a company. The methodology combined both the qualitative and quantitative research approach. The limitation of the research was with respect to volume and branch of the companies that should not be involved due to small number of response in questionnaire. From the suggested methodology is possible to analyse the maturity levels in DT of the companies and organizations.

The research successfully addressed the research questions by establishing that: while IM remains an integral part of organization’s information systems, the tasks and tools associated



with IM are undergoing significant changes in the era of DT. This is evident in the result as captured by Fig. 1, which shows the ICT preference of adoption of many of the companies covered by the survey. There was a tendency towards the traditional DMS, BI solutions, and CC solutions and use of SM were on the increase. The differences caused by IM by DT can be seen as stated earlier in the increasing adoption of CC solutions and use of SM as part of the IS strategic shift of most companies. Finally, the state of ICT use and implementation in all organizations covered by the survey is high, tending towards 100% utilization, which indicates that companies and organizations understand the importance of ICTs to the success of their business.

## References

- Affifi, W. A., & Weiner, J. L. (2004). Toward a Theory of Motivated Information Management. *Communication Theory*, 14(2), 167-190. doi: 10.1111/j.1468-2885.2004.tb00310.x
- Ahlemann, F. (2016). How Digital Transformation Shapes Corporate IT: Ten Theses about the IT Organization of the Future. *Proceedings of the Federated Conference on Computer Science and Information Systems*, 8, 3-4. doi: 10.15439/2016F597
- Bondar, S., Hsu, J. C., Pfouga, A., & Stjepandić, J. (2017). Agile digital transformation of System-of-Systems architecture models using Zachman framework. *Journal of Industrial Information Integration*, 7, 33-43. doi: 10.1016/j.jii.2017.03.001
- Carcary, M., Doherty, E., & Conway, G. (2016). A Dynamic Capability Approach to Digital Transformation: a Focus on key Foundational Themes. *The European Conference on Information Systems Management*, 20-28. Retrieved from <https://search.proquest.com/docview/1949080140?accountid=15518>
- Chen, J. E., Pan, S. L., & Ouyang, T. H. (2014). Routine reconfiguration in traditional companies' e-commerce strategy implementation: A trajectory perspective. *Information and Management*, 51(2), 270-282. doi: 10.1016/j.im.2013.11.008
- Clemons, E. K., Sawy, O., Weber, B., & Lucas, H. (2013). Impactful Research on Transformational Information Technology: An Opportunity to Inform New Audiences. *MIS Quarterly*, 37(2), 371-382. Retrieved from <https://www.jstor.org/stable/43825914>
- Dehning, B., Richardson, V. J., Zmud, R. W., & Price, M. F. (2003). The Value Relevance of Announcements of Transformational Information Technology. *MIS Quarterly*, 27(4), 637-656. doi: 10.2307/30036551
- Detlor, B. (2010). Information management. *International Journal of Information Management*, 30(2), 103-108. doi: 10.1016/j.ijinfomgt.2009.12.001
- Ernst & Young. (2011). *The digitisation of everything: How organisations must adapt to changing consumer behaviour*. Ernst & Young LLP. Retrieved from [http://www.ey.com/Publication/vwLUAssets/The\\_digitisation\\_of\\_everything\\_-\\_How\\_organisations\\_must\\_adapt\\_to\\_changing\\_consumer\\_behaviour/\\$FILE/EY\\_Digitisation\\_of\\_everything.pdf](http://www.ey.com/Publication/vwLUAssets/The_digitisation_of_everything_-_How_organisations_must_adapt_to_changing_consumer_behaviour/$FILE/EY_Digitisation_of_everything.pdf)
- Franklin, M., Halevy, A., & Maier, D. (2005). From databases to dataspace: A new abstraction for information management. *ACM Sigmod Record*, 34(4), 27-33. doi: 10.1145/1107499.1107502
- Hicks, B. J. (2007). Lean information management: Understanding and eliminating waste. *International Journal of Information Management*, 27(4), 233-249. doi: 10.1016/j.ijinfomgt.2006.12.001

- i-Scoop. (2016). *Digital transformation and information management*. Retrieved from <https://www.i-scoop.eu/digital-transformation/digital-transformation-and-information-management-enabling-change/>
- Mildeova, S., & Brixi, R. (2012). Technical Limits of ICT for Enterprises' Innovations. *Journal of Systems Integration*, 3(1), 45-53. doi: 10.20470/jsi.v3i1.107
- Mithas, S., Ramasubbu, N., & Sambamurthy, V. (2011). How information management capability influences firm performance. *MIS Quarterly*, 35(1), 237-256. doi: 10.2307/23043496
- Moen, A., & Brennan, P. F. (2005). Health@Home: The work of health information management in the household (HIMH): Implications for consumer health informatics (CHI) innovations. *Journal of the American Medical Informatics Association*, 12(6), 648-656. doi: 10.1197/jamia.M1758
- Orlikowski, W. J. (1996). Improvising Organizational Transformation over Time: A Situated Change Perspective. *Information Systems Research*, 7(1), 5-134. doi: 10.1287/isre.7.1.63
- Pan, S. L., Xianghua, L., & Huang, L. (2009). The Role of IS Capabilities in the Development of Multi-Sided Platforms: The Digital Ecosystem Strategy of Alibaba.com. *Journal of the Association for Information Systems*, 16(4), Article 2. doi: 10.17705/1jais.00393
- Riedl, R., Benlian, A., Hess, T., Stelzer, D., & Sikora, H. (2017). On the Relationship between Information Management and Digitalization. *Business & Information Systems Engineering*, 59(6), 475-482. doi: 10.1007/s12599-017-0498-9
- Robertson, J. (2005). *10 Principles of Effective Information Management*. Retrieved from [http://www.steptwo.com.au/files/kmc\\_effectiveim.pdf](http://www.steptwo.com.au/files/kmc_effectiveim.pdf)
- Thornley, C., Carcary, M., Connolly, N., O'Duffy, M., & Pierce, J. (2016). *Developing a Maturity Model for Knowledge Management (KM) in the Digital age*. Paper presented at European Conference on Knowledge Management, Kidmore End. Kidmore End: Academic Conferences International. Retrieved from <https://search.proquest.com/docview/1860279477?accountid=15518>
- Venkataraman, S. (2015). *Evolution of Information Management in the Digital Era*. Retrieved from <http://www.wipro.com/documents/evolution-of-information-management-in-the-digital-era.pdf>
- Venkataraman, N. (1994). It-Enabled Business Transformation - From Automation To Business Scope Redefinition. *Sloan Management Review*, 35(2), 73-87. Retrieved from <https://search.proquest.com/docview/224959732?accountid=15518>
- Whittaker, S., Bellotti, V., & Gwizdka, J. (2006). Email in personal information management. *Communications of the ACM - Personal information management*, 49(1), 68-73. doi: 10.1145/1107458.1107494
- Wilson, T. D. (2016). A General Theory of Human Information Behaviour. *Information Research*, 16(4), 1-19. Retrieved from <http://www.diva-portal.org/smash/record.jsf?pid=diva2%3A1062543&dswid=-8879>
- Zimmermann, A., Schmidt, R., Jugel, D., Mohring, M., & Möhring, M. (2016). Adaptive enterprise architecture for digital transformation. *Communications in Computer and Information Science*, 567, 308-319. doi: 10.1007/978-3-319-33313-7\_24

## **Contact information**

### **Fortune Nwaiwu**

Tomas Bata University in Zlín, Faculty of Management and Economics

Mostní 5139, 76001, Zlín, Czech Republic

E-mail: [nwaiwu@utb.cz](mailto:nwaiwu@utb.cz)

ORCID: 0000-0001-8900-2130

### **prof. Ing. Ladislav Buřita, CSc.**

Tomas Bata University in Zlín, Faculty of Management and Economics

Mostní 5139, 76001, Zlín, Czech Republic

E-mail: [burita@utb.cz](mailto:burita@utb.cz)

ORCID: 0000-0003-4779-631X

doi: [10.7441/dokbat.2019.080](https://doi.org/10.7441/dokbat.2019.080)

# THE CONSEQUENCES OF LEARNING ORIENTATION ON THE COMPANY PERFORMANCE

*Daniel Darius Onetiu*

## **Abstract**

In this article, we have conducted a study regarding the consequences of learning orientation on company performance. The present research addresses some major objectives, such as: identifying the effect of learning orientation on learning engagement, common vision and open approach; the effects of learning orientation on company performance, customer satisfaction, market efficiency and financial performance. The research was carried out on a sample of 50 organizations, most of them being of Romanian origin and of medium and small size. The paper presents the results of the theoretical and empirical research that were previously realized in the field of the theme and which were the basis of the formulation of the hypotheses on which we built the conceptual model of the present research. Then the main results of the empirical research are presented, and finally the conclusions, limits and future directions of research. The conclusions of the present case study emphasize the effect of the orientation towards learning, but also of the engagement in learning.

*Keywords: learning orientation, learning engagement, innovation, performance*

## **1 INTRODUCTION**

The main objectives of the research are the following: a) to identify the effect of the learning orientation on the engagement in learning, on the common vision and on the open approach; b) to identify the effect of the firm's performance on customer satisfaction, on the market efficiency and on the financial performance. The size and the age can influence the performance of the firm. Aging within the firm can be influenced positively or negatively, the different characteristics of organization and deployment of company resources (Chen, 2009). Chen also confirmed that: innovation is closely linked to organizational learning. Amabile defined the innovation as the successful implementation of creative ideas within the organization.

The work begins with a review of the theoretical and empirical research that was previously conducted in the field of the topic and which were the basis for formulating the hypotheses on which we built the conceptual model of the present research. Then the main results of the empirical research are presented, and finally the conclusions, limits and future directions of research.

## **2 LEARNING ORIENTATION ON THE COMPANY**

The concept of learning orientation is addressed in various fields, but also in the field of marketing. Marketing scientists look at organizational learning as a constantly evolving process. This is why contemporary organizations need a strong learning orientation to gain competitive advantage. While some researchers believe that behavioural change is necessary in the learning process, others insist that adopting a new way of thinking is sufficient (Nasution, 2011).

According to the specialized literature, the orientation towards learning is conceived as being composed of four dimensions: engagement in learning, common vision, open approach and exchange of intra-organizational knowledge. The latter is included because learning can only

take place if the organization has an efficient and effective information exchange system that allows a review of previous decision-making strategies and implementation activities. In addition, the relationship between learning orientation and innovation orientation is dependent on the age of the organization. The older the organization is, the stronger the link between learning orientation and innovation orientation (Calantone, 2002). It has also been studied and tested that a more positive learning orientation (value-based construct) will directly lead to an increase in market information generation and dissemination (knowledge-based construct). In turn, it directly affects the level at which organizations make changes regarding their own marketing strategies (behaviour-based construction) (Calantone, 2002).

Learning orientation refers to the activity of creating and using knowledge to enhance the competitive advantage at the company level. This in turn includes obtaining and exchanging information about customer needs, market changes and competing actions, as well as developing new technologies to create new products that are superior to those of competitors. Learning orientation influences any information, but especially how they are interpreted, evaluated and distributed. (Calantone, 2002). The engagement in learning or how the organization promotes learning is likely to foster a learning climate. The committed organization considers learning as an important and essential investment for survival. The more the organization has adopted the values of learning, the more likely it is that learning will take place. Most important is that the engagement in learning is associated with long-term strategic orientation. In other news, if an organization does not encourage knowledge development, employees will not be motivated to continue their learning activities. (Baker, 1997)

Learning in an organization results from an accumulation of individual learning. (Sinkula, 1994) Even if an organization is dedicated to learning and has a common vision, learning will be limited without the accumulation of new knowledges. Based on interviews with executive directors and a review of the literature, Calantone (2002) delimited four components of learning orientation: commitment to learning, common vision, open approach and exchange of intra-organizational knowledge.

### **3 INNOVATION ORIENTATION OF THE COMPANY**

For innovation to take place, companies can mobilize human capital to develop organizational expertise on developing new products and services. This expertise is complex, being primarily the result of deliberate practices in the field that involve people who want to fulfil tasks and strive to improve performance. Firms can identify and exercise a set of strategic human resources practices to obtain the desire and motivation of the employees to engage in the development of the organizational expertise necessary to meet the company's objectives regarding innovation performance (Calantone, 2002).

Strategic human resources practices can lead to innovative activities because they allow companies to discover and use their knowledge and expertise within the organization. However, within the organizational framework, employees do not easily share information. Even if a company has access to the knowledge, skills and experience of the employees, high management skills of the knowledge sharing tools are required to ensure the efficient use of human capital in developing the organizational expertise in innovation. Knowledge management can influence the relationship between strategic human resources practices and innovation performance. A firm must be innovative in order to survive in a volatile environment (Nasution, 2002).

Innovation represents the measure which an individual is the first in adopting something new in comparison with other individuals in the social environment, this definition being focused on the individual, not on the organization. The innovation of the company is conceptualized

from two perspectives: as a behavioural variable in a first perspective, measured as a rate of innovation adoption and as a propensity to make changes in a second perspective (Chen, 2009). Organizational culture is positively related to innovation and customer value. These relationships remain and are strong, even after controlling the effects of market orientation, learning orientation and human resources practices (Nasution, 2011). The ability to innovate is seen as the most important determinant of the company's performance, a conclusion supported by the results of several empirical studies. The literature on innovation also confirms this view and suggests that firms need to be innovative in order to gain a competitive advantage and survive. However, the link between innovation orientation and company performance needs to be further tested. (Verhoef, 2009)

## 4 RESEARCH METHODOLOGY

The present research is focused on studying the effects of learning orientation on company performance. The major objectives of the research are the following: a) identification of the effect of the employment in learning on the performance of the company; b) identification of the effect of the common vision on the performance of the company. The data were obtained through a questionnaire-based survey of a sample of 50 small and medium-sized companies in the food and pharmaceutical trade, transport, construction, services, import, IT, consulting and the production sector. The sample was constituted by a non-probabilistic method, respectively convenience sampling. Based on the theoretical foundations of the orientation towards learning, on the value for the client and the orientation towards innovation, as well as on the results of previous empirical research, we formulated the hypotheses that were the basis of the conceptual model of the research.

### 4.1 The hypotheses and conceptual model of the research

Tab. 1 – The hypotheses classification. Source: own research

H1	Engagement in learning has a direct, positive and significant influence on: a) company performance; b) customer satisfaction; c) market efficiency and d) financial performance.
H2	The common vision has a direct, positive and significant influence on: a) company performance; b) customer satisfaction; c) market efficiency and d) financial performance.
H3	The open approach has a direct, positive and significant influence on: a) company performance; b) customer satisfaction; c) market efficiency and d) financial performance.

The hypotheses regarding the relationships between the orientation to learning, the practices of human resources regarding the workplace, the practices of human resources regarding the reward and the performance of the company are the basis of the conceptual model of the present research, model presented in the following figure.

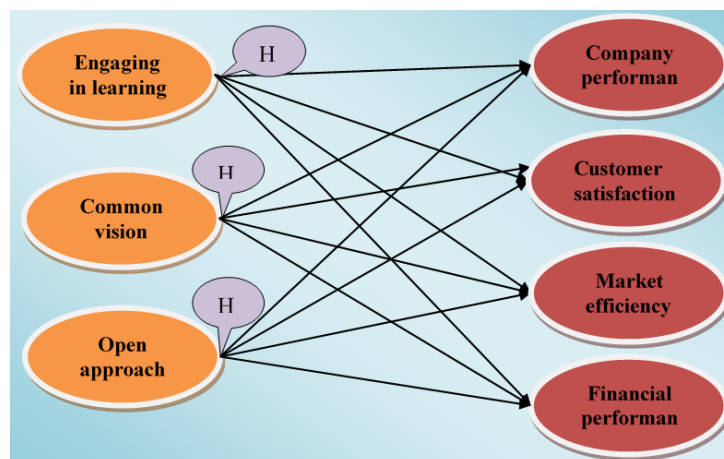

Fig. 1 – The conceptual model of the research. Source: own research

The scales used to measure the constructs used in the research were taken from previous research in which they were validated. Tables 2 and 4 show the operating mode of each construct, the variable codes, the items of the scales and the sources from which the respective scales were taken.

Tab. 2 – Learning orientation. Source: Nasution (2011)

Construct	Items of scale	Codes vary balls
Engaging learning	(1) The ability of the organization to learn is considered a very important competitive advantage.	AOLCVICA
	(2) Learning the values of the organization is the key factor of the improvement.	LVOKFI
	(3) Employee learning is an investment.	ELI
	(4) The survival of the organization is guaranteed by learning.	SOGL
Common vision	(5) Discontinuation of learning endangers the future of the organization.	DLEFO
	(6) The knowledge by the employees of what we want to achieve	KEFO
	(7) Employees are committed to meeting the organizational objectives.	ECMOO
	(8) Existence of a complete agreement on the organizational vision of all departments.	ECAOVD
	(9) In establishing the direction of the organization, employees are considered partners.	EDOECF
	(10) Management shares its own vision of the organization with all employees.	MSOVOWE
Open approach	(11) Very well-defined vision for the organization by the management.	VWDVOM
	(12) The common approach to doing business is critically reflected.	CADBCR
	(13) Employees open to new and change are valued.	EONCV
	(14) Encouraging employees to contribute original ideas for organizational success.	EEOOS
	(15) Very high appreciation of original ideas.	VHAOI

Tab. 3 – Performance Measures (company performance). Source: Vorhies & Morgan (2005)

Construct	Items of scale	Variable codes
Customer satisfaction	(1) Customer satisfaction	CS
	(2) The size of the value offered to customers	SVOC
	(3) Meeting the expectations of customers	MEC
Market efficiency	(4) Maintaining valuable customers	MVC
	(5) Market share in relation to competition	MSRC
Financial performance	(6) Increased sales revenue	ISR
	(7) Attracting new customers	ANC
	(8) Increase sales to existing customers	ISEC
	(9) Profitability of the business unit	PBU
	(10) Return on investment	RI
	(11) Profitability of sales	PS
	(12) Meeting the financial objectives	MFO

For the statistical analysis of the data, the completed questionnaires were analysed from the point of view of the complete character of the answers and the existence of a variation in the answers formulated to the scale questions. Through a univariate descriptive analysis, we identified the profile of the companies in the sample. In analysing the reliability of the measurement scales, we used the alpha-Cronbach coefficient, the main purpose being the purification of the scales and the assurance that the items used measure the same construct. We considered a scale reliable if alpha-Cronbach was greater than 0.7 (Nunnally, 1978). The Kaiser-Meyer-Olkin indicator and Bartlett sphericity test were used to determine the opportunity to use factorial analysis. A value of at least 0.7 of the Kaiser-Meyer-Olkin indicator indicates the opportunity to perform the factorial analysis, and a significance level of the Bartlett sphericity test of less than 0.05 confirms a strong correlation between the variables and indicates the presence of one or more common factors that justify the application of factor analysis. We have retained the variables with a factorial load of at least 0.5 within each

construct. We tested the research hypotheses using linear regression analysis, depending on the significance level  $p$ , taking the decision to accept or reject each hypothesis.

We tested the research hypotheses using linear regression analysis, depending on the significance level  $p$ , taking the decision to accept or reject each hypothesis.

In order to carry out the hypothesis testing, the following statistical models were designed and used:

$$M1: EL + CV + OP = CP$$

$$M2: EL + CV + OP = CS$$

$$M3: EL + CV + OP = ME$$

$$M4: EL + CV + OP = FP$$

*EL = engaging in learning*

*CV = common vision*

*OP = open approach*

*CP = Company performance*

*CS = customer satisfaction*

*ME = market efficiency*

*FP = financial performance*

## 4.2 Research results

### The characteristics of the companies in the sample

The sample consists almost entirely of companies with full capital of Romanian origin, most being small and medium-sized companies. The origin of company capital: the majority contribution in the total sample is held by companies that have a Romanian capital with a 84%, followed by the ones with foreign capital 10%.

### Reliability of the measurement scale of the construction "Employment in learning"

The 5-item scale used to measure learning engagement shows a Cronbach's alpha coefficient level of 0.823, the scale used in measurement being reliable (Nunnaly, 1978).

Tab. 4 – Reliability of the measurement scale of the “Employment in learning”. Source: own research

The variable code	The variable name	Corrected item-total correlation	Alpha Cronbach if item is removed
TAOLCVICA	The ability of the organization to learn is considered a very important competitive advantage.	0, 625	0,787
LVOFI	Learning the values of the organization is the key factor of improvement.	0, 667	0,772
ELI	Employee learning is an investment.	0, 708	0,777
SOGTL	The survival of the organization is guaranteed through learning.	0, 594	0, 794
DLEFO	Discontinuation of learning endangers the future of the organization.	0, 602	0, 812



No variable affects the level of the Alpha-Cronbach coefficient. The KMO indicator has a value of 0.830 ( $> 0.7$ ) and the Bartlett sphericity test of 87.059 at a significance level of  $p = 0.000$ . The variables within this scale are significantly intercorrelated statistically, thus indicating a reliable scale. In order to extract the factors, the analysis was used in the main components. The extracted factor explains 61.221% of the total variance of the 5 items. The Pearson correlation coefficient between the 5 variables has a significance level of 0.000. All correlations are statistically significant, resulting in the present construct having convergent validity.

### Reliability of the measurement scale of the “Open approach” construct

The 3-item scale used to measure the open approach shows a Cronbach's alpha coefficient level of 0.821, the scale used in measurement being reliable (Nunnaly, 1978).

Tab. 5 – Reliability of the measurement scale of the “Open approach”. Source: own research

The variable code	The variable name	Corrected item-total correlation	Alpha Cronbach if item is removed
TCADBCR	The common approach to doing business is critically reflected.	0,634	0,780
EONCV	Employees open to new and change are valued.	0,494	0,836
EEOIOS	Encouraging employees to contribute original ideas to organizational success	0,739	0,727

Although the variable "Employees open to new and change are valued" reduces the overall reliability of the measurement scale, being a dependent variable in the analysis of hypotheses and the degree to which the reliability of the scale is reduced being quite small, it will be retained. The KMO indicator has a value of 0.753 ( $> 0.7$ ) and the Bartlett sphericity test of 75.251 at a significance level of  $p = 0.000$ . The variables within this scale are significantly intercorrelated statistically, thus indicating a reliable scale. In order to extract the factors, the analysis was used in main components. The extracted factor explains 65.346 % of the total variance of the 3 items. The Pearson correlation coefficient between the 3 variables has a significance level of 0.000. All correlations are statistically significant, resulting in the present construct having convergent validity.

### Reliability of the measurement scale of the “Common vision” construction

The 3-item scale used to measure common vision shows a Cronbach's alpha coefficient level of 0.793, the scale used in measurement being reliable (Nunnaly, 1978).

Tab. 6 – Reliability of the measurement scale of the “Common vision”. Source: own research

The variable code	The variable name	Corrected item-total correlation	Alpha Cronbach if item is removed
EKWVWA	Employees' knowledge of what we want to achieve	0,619	0,741
ECMOO	Employees are committed to meeting organizational objectives.	0,656	0,711
ECATOVD	Existence of a complete agreement on the organizational vision of all departments.	0,648	0,704

Initially, this measurement scale of the Common Vision construct consisted of 6 items. Due to the fact that certain items reduce the reliability of the scale, they were eliminated. These items are: "In establishing the direction of the organization, the employees consider themselves partners", "The management shares his own vision on the organization with all the employees." and "A vision very well defined for the organization by the management". Therefore, in the end, no variable negatively affects the level of the alpha-Cronbach coefficient. The KMO indicator has a value of 0.709 ( $> 0.7$ ), and the Bartlett sphericity test of 42.923, at a significance level of  $p = 0.000$ . The variables within this scale are significantly intercorrelated statistically,

thus indicating a reliable scale. In order to extract the factors, the analysis of the main components was used. The extracted factor explains 71.296 % of the total variance of the 3 items. The Pearson correlation coefficient between the 3 variables has a significance level of 0.000. All correlations are statistically significant, resulting in the present construct having convergent validity.

**Results of the testing of hypothesis H1:** Engagement in learning has a direct, positive and significant influence on: a) company performance; b) customer satisfaction; c) market efficiency and d) financial performance.

Tab. 7 – Results of the testing of hypothesis H1. Source: own research

Assum.	The model used	Significance level p of the model	The standardized beta coefficient	The value of the statistics t	Significance level p of the concept	Coefficient of determination R <sup>2</sup>	Result
H1a	M1	0.064	0.389	2.488	0.017	0.147	accepted
H1b	M2	0.008	0.473	3.174	0.003	0.228	accepted
H1c	M3	0.195	0.334	2.078	0.043	0.098	rejected
H1d	M4	0.354	0.217	1.318	0.194	0.069	rejected

From the above table it can be observed that in the case of the research hypothesis H1a, according to the model used M1, the engagement in learning has a direct, positive and significant influence on the performance of the company, registering a standardized beta coefficient of 0.389, with a significance level  $p = 0.017$ , the hypothesis being partially accepted because in the M5 model, the effect of this variable on the firm's performance is not significant. The coefficient of determination R<sup>2</sup> of the M1 model is 0.147, explaining 14.7% of the variation of the company's performance. The model M5, however, has a coefficient of determination R<sup>2</sup> equal to 0.248, being superior in terms of explanatory power.

Hypothesis H1b is also partially accepted, according to the model used M2, learning engagement has a direct, positive and significant influence on customer satisfaction, registering a standardized beta coefficient of 0.473, with a significance level  $p = 0.003$ , the hypothesis being partially accepted because in model M6, the effect of this variable on the firm's performance is not significant. If, besides the dimensions of the orientation towards learning, the human resources practices regarding the job and the reward are introduced in the model, the effect of the engagement in learning becomes insignificant. The coefficient of determination R<sup>2</sup> of the M2 model is 0.228, explaining 22.8% of the variation of the company's performance. Model M6, however, has a coefficient of determination R<sup>2</sup> 0.326, being superior in terms of explanatory power. The other assumptions cannot be validated, because the significance levels p of the related concept does not present a statistically significant level.

**Hypothesis testing results H2:** The common vision has a direct, positive and significant influence on: a) company performance; b) customer satisfaction; c) market efficiency and d) financial performance.

Tab. 8 – Hypothesis testing results H2. Source: own research

Assum.	The model used	Significance level p of the model	The standardized beta coefficient	The value of the statistics t	Significance level p of the concept	Coefficient of determination R <sup>2</sup>	Result
H2a	M1	0064	0.024	0.156	0.877	0.147	rejected
H2	M2	0008	0.047	0.323	0.748	0.228	rejected
H2c	M3	0195	0.078	0.502	0.618	0.098	rejected
H2d	M4	0354	-0.070	-0.441	0.661	0.069	rejected

As can be seen, the hypotheses cannot be validated, because the significance level p for the model used does not present a statistically significant level. Therefore, the variable common

vision does not have a direct, positive and significant influence on: company performance, customer satisfaction, market efficiency and financial performance.

**Test results of hypothesis H3:** The open approach has a direct, positive and significant influence on: a) company performance; b) customer satisfaction; c) market efficiency and d) financial performance.

Tab. 9 – Test results of hypothesis H3. Source: own research

Assum.	The model used	Significance level p of the model	The standardized beta coefficient	The value of the statistics t	Significance level p of the concept	Coefficient of determination R <sup>2</sup>	Result
H3	M1	0.064	-0.027	0.160	0.873	0.147	rejected
H3b	M2	0.008	-0.020	-0.129	0.898	0.228	rejected
H3C	M3	0.195	-0.140	-0.822	0.415	0.098	rejected
H3D	M4	0.354	0.103	0.596	0.554	0.069	rejected

We note in the table above that the hypotheses cannot be validated, because the significance level p of each related model does not present a statistically significant level. Therefore, the variable open approach does not have a direct, positive and significant influence on: company performance, customer satisfaction, market efficiency and financial performance.

## 5 CONCLUSIONS

Finally, concluding what we analysed in the above study, we can say that, the conclusions of the present study regarding the relations between certain dimensions of the learning orientation and the performance of the company reflect or not their influence on the success of the organizations. Most of the companies on which the sample was made have a maximum number of 9 employees (42%). The people who completed the sample were mostly the administrators of the respective companies (38% of the sample), but also people with at least two years' experience within the companies. Analysing in more detail the results of the case study, during the research I observed that the orientation towards learning, aggregated as a construct applied to the present sample, is not valid. So, I took each dimension of the construct and tested it. As can be seen from the tables above, the only valid hypothesis was that regarding the influence of learning engagement on performance. The other two hypotheses regarding the dimensions of the orientation to learning, respectively the common vision and the open approach, have not been validated. The results of the present research are useful for the managerial practices of the companies, as well as of the educational institutions we could say. In order to meet the established performance objectives, the top management teams must ensure a high level of human resources practices in terms of reward and a high level of engagement in learning. It should be emphasized that, in order to have satisfied customers, a reward based on the efforts made is essential, as well as the fact that the organization will assume responsibility and will commit itself to provide training.

The main limits of this research are generated by the small size of the sample on which the research was carried out and the relatively homogeneous structure of the sample, which includes dominant companies from a single sector of activity (retail trade with food products). In the future, research in the chosen topic area can be continued by detailing data analysis using advanced methods. For example, in the multivariate regression analysis, variables can be introduced that capture the complementarity of the contributions of human resources practices and the dimensions of the learning orientation on the firm's performance. Also, the cluster analysis can be used to identify the particularities in the manifestation of the relationships investigated within the different categories of companies.

## Acknowledgement

This work was co-financed from the European Social Fund through Operational Programme Human Capital 2014-2020, project number POCU/380/6/13/125015 "Development of entrepreneurial skills for doctoral students and postdoctoral researchers in the field of economic sciences."

## References

- Baker, W., Noordewier, T., & Sinkula, J. (1997). A Framework for Market-Based Organizational Learning: Linking Values, Knowledge and Behavior. *Journal of the Academy of Marketing Science*, 25(4), 305-318. doi: 10.1177/0092070397254003
- Calantone, J. R., Cavusgil, S.T., & Zhao, Y., (2002). Learning orientation, firm innovation capability, and firm performance. *Industrial Marketing Management*, 31(6), 515-524. doi: 10.1016/S0019-8501(01)00203-6
- Chen, C. J., & Huang, J.-W. (2009). Strategic human resource practices and innovation performance: The mediating role of knowledge management capacity. *Journal of Business Research*, 62(1), 104-114. doi: 10.1016/j.jbusres.2007.11.016
- Nasution, H., Mavondo, F., Matanda, M., & Ndubisi N. (2011). Entrepreneurship: Its relationship with market orientation and learning orientation and as antecedents to innovation and customer value. *Industrial Marketing Management*, 40(3), 336-345. doi: 10.1016/j.indmarman.2010.08.002
- Homburg, C., Workman, J. P., & Krohmer H. (1999). Marketing's Influence Within the Firm. *Journal of Marketing*, 63(2), 1-17. doi: 10.2307/1251942
- Kirca, A. H., Jayachandran, S., & Bearden, W. O. (2005). Market Orientation: A Meta-Analytic Review and Assessment of Its Antecedents and Impact on Performance. *Journal of Marketing*, 69, 24-41. doi: 10.1509/jmkg.69.2.24.60761
- Sinkula, J. M. (1994). Market Information Processing and Organizational Learning. *Journal of Marketing*, 58, 35-45. doi: 10.1177/002224299405800103
- Verhoef, P. C., & Leeflang, P. S. H. (2009). Understanding the Marketing Department's Influence Within the Organization. *Journal of Marketing*, 73, 14-34. Retrieved from [https://www.rug.nl/staff/p.c.verhoef/jm\\_marketing\\_influence.pdf](https://www.rug.nl/staff/p.c.verhoef/jm_marketing_influence.pdf)

## Contact information

### Daniel Darius Onetiu

WEST UNIVERSITY OF TIMIȘOARA, Faculty of Economy and Business Administration  
Pestalozzi Bd. 16, Timișoara 300115, Timiș, Romania

E-mail: [darius.onetiu@gmail.com](mailto:darius.onetiu@gmail.com)

ORCID: 0000-0001-6634-5456

doi: 10.7441/dokbat.2019.081

# TRENDS IN FINANCIAL PERFORMANCE ASSESSMENT OF TRAVEL AGENCIES

*Erika Onuferová, Veronika Čabinová, Peter Gallo, Mária Matijová,  
Nikola Sikorová Jurová*

## Abstract

In today's dynamic business environment influenced by markets globalization, the ongoing pressure on increasing enterprise performance leads to creating new trends in financial performance system. Therefore, selecting the indicators and methods reflecting the financial performance of enterprises belongs to the key elements of improving their competitiveness and meeting long-term goals related to economic prosperity. The aim of this article is to assess the financial performance of Slovak travel agencies using modern methods in order to create performance portfolio based on average data over the years 2013-2017. Moreover, the attention was focused on comparison of selected financial methods via concordance rate ranking of the selected business entities. For measurement of enterprise financial performance, method of Principal component analysis (PCA) and Creditworthy model (CWM) were applied. In this regard, the best results were achieved for Pelicantravel.com, Ltd., on the contrary, AZAD, Ltd. was identified as the worst performing one. The research findings revealed that the performance portfolio of travel agencies by applying a multidimensional PCA method provide identical results compared to the method of CWM ( $r_s = 0.7459$ ). According to the PCA results, 11 travel agencies were classified as well-performing, while 30 enterprises were identified as non-performing. In the case of CWM assessment, 2 business entities achieved excellent results, while 4 travel agencies reached inappropriate results. In our opinion, presented findings can be useful for financial managers of travel agencies. In practice, results can help to reveal potential improvement opportunities. It is a simplified way for managers to review its business financial operations and to create suitable financial strategy.

*Keywords: Enterprise performance, Trends in financial assessment, Principal component analysis, Creditworthy model, Travel agencies*

## 1 INTRODUCTION

Tourism belongs to the most dynamic developing sectors in the world. According to Kajzar (2018), the dynamics of development have turned tourism into a key driver for socioeconomic progress. For this reason, tourism sector belongs to significant economic components. In this regard, Ghosh (2019) explored the causal association of economic uncertainty between tourism and selected macroeconomic variables. In the long run, findings showed that current economic uncertainty adversely affects the tourism sector. The development in Slovakia indicates that tourism sector has a great potential to positively influence and support the country's economy. As reported by Sofronov (2018), the positive trend in the tourism industry is associated with all the kinds of economic effects, with profound social, political, cultural and economic implications. Of course, business entities (including travel agencies) are an important part of this economic system. As participants in creating a tourism offering and as initiators of tourist demand, travel agencies represent a key segment of the tourist market.

Demand for travel agencies (TAs) services increases under the influence of various aspects, such as freedom of travel, lifestyle changes as well as people's growing desire to explore new destinations. Nowadays, we often get to hear unfavourable news regarding the bankruptcy of

TAs, not only in Slovakia, which has a negative impact on many subjects. For example, the oldest TA in the world - British Thomas Cook got bankrupt few months ago (after 178 years of existence). The Slovak Association of Tour Operators and Travel Agents (SACKA 2019) considers the development of organized tourism to be optimistic and favourable. Last year, 633.5 thousand people travelled abroad using domestic TAs services, which is a year-on-year increase by 7 %. Despite this fact, 20 travel agencies have already gone bankrupt so far in Slovakia. The analysis revealed that unfavourable financial situation and inadequate insurance belong to main reasons of bankruptcy. For this reason, we have focused on assessing the financial performance of a selected sample of TA in Slovakia and to identify the best and worst enterprises by applying modern financial methods.

The article is structured as follows. The first chapter contains introduction and the justification for the topic importance. The second chapter involves literature review and theoretical description of used methods briefly. The third chapter contents research methodology and describes aim of research, research sample, research question, statistical methods and its mathematical and statistical processing. The fourth chapter involves presentation of the results. The last chapter offers a summary of the article, research findings, recommendation for managerial practice, including discussion section.

## **2 THEORETICAL BACKGROUND OF THE ENTERPRISE PERFORMANCE**

The economy globalization greatly increases the requirements placed on assessing business performance. In an intensive competitive environment, only those businesses are progressing, which pay attention to financial situation at sufficiently measure and achieve stated objectives in accordance with financial plans. However, according to Huttmanova & Valentiny (2019), their achievement is complicated and difficult in practice. Therefore, the assessment of company's financial situation is an essential part of its financial management. In this context, we can state that measurement of enterprise financial performance and its evaluation belongs to basic identifiers of the overall enterprise success in the local and global market.

According to Vochozka, Rownland & Vrbka (2016), it is important to select the performance criteria that will reflect the key factors for business performance growth because it is not possible to determine it with one performance indicator. Authors Kozena, Jelinkova (2014) agree and emphasize that the right choice of performance measurement methods, considering company specifics, can highlight in time the key issues and shortcomings that need to be eliminated and where the business does not reach full potential. However, according to Hyranek, Grell, Nagy & Durinova (2018), each model of performance measurement and prediction uses different mathematical tools and works with different indicators. As reported by Sofrankova, Kiselakova & Horvathova (2017), there are appearing significant changes not only within the performance measurement approaches, but also changes affecting the performance evaluation methods.

At present, modern methods and indicators, such as predictive financial analysis and non-financial criteria, are preferred. The basic objective is to maximize the enterprise market value. To the most popular modern measures of the enterprise performance assessment belong indicators such as Economic Value Added, Return on Net Assets and non-financial methods such as Balanced Scorecard, etc. In addition, as reported by Al-Eideh's (2016), performance evaluation trends tend to use statistical tools enabling performance quantification much more efficient and comprehensive. In the connection of presented findings, in this paper we decided to apply two selected modern methods to assess the enterprise performance of the selected

sample, namely the Creditworthy model (CWM) and the statistical method, Principal component analysis (PCA).

The issue of TAs performance assessment was investigated in many research papers. For example, authors del Alonso-Almeida, Bagur-Femenias & Llach (2017) focused on examining the motivations for adopting quality practices and their impact on the performance of travel agencies. Findings showed that the adoption of quality practices significantly impacts the competitiveness and financial performance of travel agencies. Furthermore, Holjevac & Basan (2009) examined the relations between internal marketing factors and the performance of travel agencies. Based on the results, authors concluded that the analysis of business performance represents a basis for managers in making business decisions. Authors Aguiar-Quintana, Moreno-Gil & Picazo-Peral (2016) provided insight into the trends affecting travel agencies and propose strategies to improve their performance and competitiveness. The purpose of research presented by Misoc (2018) was to point out the methods used nowadays to evaluate the travel agents' performance. The results of the research showed that the most important criteria taken into account when it comes to evaluate the performance of travel agents are: the sales volume achieved by the employees, the number of customers, the average time for solving the customers' demands, the number of complaints received, the image and behavior of the employees. According to Lin (2011), financial performance of travel agencies is influenced by market orientation and competitive environment.

## **2.1 Principal Component Analysis**

The PCA has a wide use in the financial field, but not only there. According to Benasseni (2018), the original data extracts characteristic features and at the same time reduces the dimensionality of the set of multivariate observations, while it is important to preserve as much as possible of their original variability. As reported by Nobre & Neves (2019), the PCA is used to reduce the dimensionality of the financial input data set. Authors confirmed the importance of the PCA method in assessment and the results obtained show that it greatly improves the performance of the system. Simionescu & Dumitrescu (2018) in their study used the PCA method to quantify the principal financial factors to examine the relationship between financial performance and business social responsibility. Kocmanova, Docekalova, Lace & Nemecek (2017) applied the PCA method in the process of determining the weights of the indicators within the analysed index. Jiang, Li & Cai (2018) made comprehensive evaluation of the economic performance of fifteen information technology companies by PCA and concluded that PCA is an effective method for enterprise economic performance comprehensive evaluation. Kristjanpoller & Minutolo (2018) also implemented the above-mentioned method in the field of monetary policy and financial sector prediction. Robu & Istrate (2015) applied PCA to identify the principal components of financial statements.

## **2.2 Creditworthy model**

CWM was created by authors Horvathova, Mokrisova as part of solving the scientific research tasks within the grant scheme, as modification of the creditworthiness model. The CWM of performance is not the subject of many empirical studies. Horvathova & Mokrisova (2014) analysed the performance of the selected transport companies operating in the Slovak Republic using different diagnostic methods, including a CWM of performance. By various modifications of CWM were dealt by the authors Horvathova & Sofrankova (2012). The authors implemented this new performance evaluation method within the selected enterprises, demonstrated its calculation and graphically displayed the position of the enterprise in the final performance fields. The implementation of the model was also discussed in study of Horvathova, Mokrisova, Suhanyiova & Suhanyi (2015). They focused on creating a modified

CWM of performance with the application of key performance indicators and risk factors within the selected industry. Onuferova & Cabinova (2018) created 3D CWM of performance and to supplement its third dimension by applying the selected modern assessment indicators – the Economic Value Added and the Return on Net Assets.

### 3 METHODOLOGY AND DATA

The aim of this article is to assess the financial performance of enterprises operating in services sector using modern methods with the view of setting performance portfolio based on average available data over the years 2013-2017. For measurement of enterprise financial performance, the method of PCA and CWM were applied. Moreover, the attention was focused on comparison of chosen financial methods via concordance rate ranking of the selected business entities. We believe that business performance should be analysed from different financial points of view, so we defined the following research question (RQ): Is the travel agency performance portfolio identical when applying both applied methods (PCA and CWM) over the analysed period? In order to determine the concordance rate of order of the analysed TAs performance based on the PCA method and the EVA indicator, Spearman's rank order correlation was applied. Its mathematical expression is given in the text below (Sharma, 2007). All the statistical analyses were processed in STATISTICA 13.1.

$$r_s = 1 - \frac{6 \sum_{i=1}^n (x_i^* - y_i^*)^2}{n(n^2 - 1)} \quad (1)$$

$r_s$  – Spearman's coefficient,

$n$  – number of observations,

$(x_i - y_i)$  – the difference between the ranges of the corresponding variables

#### 3.1 Research sample

The research sample consists of 57 TAs operating in Slovakia, which according to the statistical classification of economic activities (SK NACE Review 2) belong to section N - Administrative and support services, namely to subclass 79120: Travel agency activities. The resulting research sample was compiled by the TAs listed in Table 1.

Tab. 1 – Overview and numeric designation of the analysed companies. Source: own research

Business name of travel agency	Business name of travel agency
TA 01 <i>Aeolus, Ltd.</i>	TA 30 <i>Jazz Welt, Ltd.</i>
TA 02 <i>AGRITOURS Slovakia, Ltd.</i>	TA 31 <i>JG SPORT AGENCY, Ltd.</i>
TA 03 <i>BOMBOVO, cestovná kancelária, Ltd.</i>	TA 32 <i>KARTAGO TOURS, Inc.</i>
TA 04 <i>BUBO travel agency, Ltd.</i>	TA 33 <i>Koala Tours, Inc.</i>
TA 05 <i>CASSOFIN, Inc.</i>	TA 34 <i>LG TRADE, Ltd.</i>
TA 06 <i>Cestovná kancelária ECOMM, Ltd.</i>	TA 35 <i>MAGIC Travel, Ltd.</i>
TA 07 <i>Cestovná kancelária FIFO, Ltd.</i>	TA 36 <i>Maximum Travel, Ltd.</i>
TA 08 <i>CK AZAD, Ltd.</i>	TA 37 <i>MILLENNIUM TRAVEL, Ltd.</i>
TA 09 <i>CK EUROTOUR, Ltd. Stropkov</i>	TA 38 <i>NA DOSAH, Ltd.</i>
TA 10 <i>CK FANY, Ltd.</i>	TA 39 <i>ONE WORLD Travel, Ltd.</i>
TA 11 <i>CK Slniečko, spol. Ltd.</i>	TA 40 <i>Orex Travel, Ltd.</i>
TA 12 <i>CK TRGOTURS, Ltd.</i>	TA 41 <i>PEGAS TOUR, Ltd.</i>
TA 13 <i>CKM 2000 Travel, Ltd.</i>	TA 42 <i>Pelicantravel.com, Ltd.</i>
TA 14 <i>CORADO, Ltd.</i>	TA 43 <i>PHARMAEDUCA, Ltd.</i>
TA 15 <i>DERTOUR Slovakia, Ltd.</i>	TA 44 <i>Premier Sport Tour, Ltd.</i>
TA 16 <i>Desirea, Ltd.</i>	TA 45 <i>Relaxos, Ltd.</i>
TA 17 <i>DUBTOUR, Ltd.</i>	TA 46 <i>SATUR TRAVEL, Inc.</i>



TA 18	<i>ETI Slovensko, Ltd.</i>	TA 47	<i>SENECA TOURS, Ltd.</i>
TA 19	<i>EZOTOUR, Ltd.</i>	TA 48	<i>SETTOUR SLOVAKIA, Ltd.</i>
TA 20	<i>Fantázia dp, Ltd.</i>	TA 49	<i>SKI TRAVEL-PROEVENTS, Ltd.</i>
TA 21	<i>FERROTOUR, Inc.</i>	TA 50	<i>SOLVEX, Ltd.</i>
TA 22	<i>FIRO-tour, Ltd.</i>	TA 51	<i>SUNFLOWERS agency, Ltd.</i>
TA 23	<i>GLOBTOUR GROUP, Inc.</i>	TA 52	<i>TIP travel, Inc.</i>
TA 24	<i>GO Travel Slovakia, Ltd.</i>	TA 53	<i>Travelco, Ltd.</i>
TA 25	<i>Happy Travel.sk, Ltd.</i>	TA 54	<i>TUI Reise Center Slovensko, Ltd.</i>
TA 26	<i>HEPEX – Slovakia, Ltd.</i>	TA 55	<i>VIP Travel, Ltd.</i>
TA 27	<i>HYDROTOUR, cestovná kancelária, Inc.</i>	TA 56	<i>VIP Travel, Ltd.</i>
TA 28	<i>INCOFF AEROSPACE, Ltd.</i>	TA 57	<i>VULPES-NR, Ltd.</i>
TA 29	<i>INTERBUS, Ltd.</i>		

At present, thousands of TAs operate in Slovak market. However, it was complicated to involve all TAs, so we decided to choose only sample of enterprises. The sample was selected on the basis of predetermined criteria. All TAs met the following criteria during the analysed years: (a) TAs had to have positive value of equity, (b) TAs had to achieve profit over the current accounting period, (c) TAs had to employ more than 9 employees (micro-enterprises were excluded), (d) TAs had to be only Ltd. or Inc. enterprises.

The input data in the form of financial statements of the TAs analysed, considering all the above criteria, were obtained from internet portal managed by a company DataSpot, Ltd., which offers a database of Slovak business entities.

### 3.2 Methods

The performance of TAs was quantified by the method of PCA. The method is one of the basic data compression methods, where the original "n" variables can be represented by a smaller number of "m" variables, while retaining a sufficiently large part of the variability of the original data set so as not to lose information. The system of new variables (principal components) consists of linear combinations of original variables and is created gradually. The first principal component accounts for the largest portion of the variability of the original data set, the other principal components contribute to the overall scatter by a smaller share. This method does not require the input variables to have a multidimensional normal distribution (Kral, Kanderova, Kascakova, Nedelova & Bojdova, 2009). The study of Fan, Liao & Mincheva (2013) shows that PCA is closely connected to factor analysis. This motivates new methodological developments in multiple testing problems when tens of thousands of possibly dependent statistical tests are evaluated simultaneously (Fan, Xue & Yao, 2017), which partially solve the high dimensional inference problem. Hebak, Hustopecky, Jarosova & Pecakova (2010) emphasize the necessary condition for using the PCA method, there must be a correlation between the original variables. The search for the principal components is as follows: (1) to create a correlation matrix from the input data (the first step of the analysis implies testing the data using the Kaiser-Meyer-Olkin-s (KMO) test); (2) to quantify eigenvalues (i.e. the variability captured by particular component): (a) to determine the eigenvalues of the correlation matrix, (b) to appoint allocated ratios of the variability assigned to the components, (c) to identify cumulative ratios of variability to determine how many principal components needs to be taken into account; (3) to select the number of principal components based on the predefined rule; (4) to determine the correlation coefficients of the principal components (factor coordinates of variables - the higher coefficient indicates that variable more affects new principal component); (5) to quantify component weight for individual variables; (6) to display graphically the original variables in the coordinate system where the axes are formed from the first two principal components (performance portfolio).

The coefficients and weights of the principal components are estimated according to the following rules, as reported by Hebak, Hustopecky, Jarosova & Pecakova (2010):

(a) The total variability of the principal components will not change - the variance of the new and original variables equals 1, i.e.:

$$\sum a_{ij}^2 = 1$$

$$a_{i1}^2 + a_{i2}^2 + \dots + a_{ip}^2 = 1, \text{ for each } i=1;2; \dots ; p \quad (2)$$

(b) The independence of the new variables, i.e. the principal components, is ensured, i.e.:

$$a_{i1}a_{j1} + a_{i2}a_{j2} + \dots + a_{ip}a_{jp} = 0 ; i \neq j$$

$$i, j = 1;2; \dots ; p \quad (3)$$

(c) All properties of the principal components are respected, i.e.:

$$E(Y_i) = 0$$

$$D(Y_i) = \lambda_i$$

$$D(Y_1) \geq D(Y_2) \geq D(Y_3) \dots \geq D(Y_p) = \lambda_1 \geq \lambda_2 \geq \lambda_3 \dots \geq \lambda_p$$

$$cov(Y_i, Y_j) = 0 ; i \neq j \quad (4)$$

In the next section, the assessment of TAs was realized by CWM of performance. As reported by Horvathova & Mokrisova (2014), this model analyses and graphically illustrates the position of the enterprise in individual portfolios in terms of two dimensions – the financial performance and company's success. The position of the enterprise is determined by cross point of the values that are plotted along the x-axis and the y-axis. The company's success is plotted along the y-axis and it is determined by the recalculation of prediction models' values using a scoring table. Each chosen prediction model can get a maximum of 20 points, thus the maximum number of points that an enterprise can obtain is 80 points. In this paper were included the following prediction models: Quick Test, Altman's Model, Taffler's Model, and Creditworthiness Index. The results of financial performance indicators converted into points by using the transformation table are plotted along the x-axis. In this dimension, 10 financial ratio indicators were chosen, whereas each of them can get a maximum of 8 points (80 points in total). The choice of indicators compared to the original model was modified. We decide to apply the indicators that include risk factor to calculate the cost of equity, namely Current liquidity, Interest coverage ratio, Return on assets and Rate of financial independence. We also selected indicators that represent the upper and lower branches of the INFA model, namely Return on sales, Assets turnover ratio and Return on equity. We also included financial risk indicators, such as Total indebtedness and the Business safety indicator. The ten of financial indicators was closed by the activity indicator, which was identified as the most important one, namely the Turnover money period. However, other modern indicators representing key performance indicators can also be incorporated into the model. We can determine the position of the enterprise within the five performance fields (Inappropriate, Doubtful, Substandard, Watch, Excellent) that are presented in the following Figure 1, based on the cross point of the values achieved.

<b>Enterprise's success</b>	<b>80</b>	Inappropriate	Doubtful	Substandard	Watch	Excellent
	<b>64</b>	Inappropriate	Doubtful	Substandard	Watch	Watch
	<b>48</b>	Inappropriate	Doubtful	Substandard	Substandard	Substandard
	<b>32</b>	Inappropriate	Doubtful	Doubtful	Doubtful	Doubtful
	<b>16</b>	Inappropriate	Inappropriate	Inappropriate	Inappropriate	Inappropriate
		<b>16</b>	<b>32</b>	<b>48</b>	<b>64</b>	<b>80</b>
		<b>Financial performance</b>				

Fig. 1 – Framework of Creditworthy model. Source: Horvathova & Mokrisova (2014)

## 4 RESULTS

Based on the information database from the financial statements, the performance of selected TAs was quantified using the PCA method. Firstly, before the calculating and determining the principal components, it is necessary to check that the original variables are correlated. If the correlation between the variables was not confirmed, there would be no point in continuing this analysis. The initial information concerning the correlation structure of the research sample was obtained from the implementation of a correlation matrix of the selected 29 financial indicators (on average over the analysed period) subsequently entering the analysis of the principal components. The correlation matrix confirmed the existence of statistically significant positive and negative dependencies among the indicators. As the KMO value is greater than 0.6, we were able to continue with the testing.

In the next part of the paper we have already proceeded to the PCA it-self. The aim was to define the number of principal components that can be used to describe the monitored financial indicators. In general, the number of principal components is always less than the number of input variables. The first principal component represents the greatest variability of the primary variables, the other components are always less variable. In the following Table 2 are presented eigenvalues of the correlation matrix and related statistics.

Tab. 2 – Eigenvalues of correlation matrix. Source: own research

Component	Principal Component Analysis => 29 indicators			
	<i>Eigenvalues</i>	<i>% of variance</i>	<i>Eigenvalues cumulative</i>	<i>Eigenvalues cumulative (%)</i>
01	6.336049	21.84844	6.33605	21.8484
02	4.305304	14.84587	10.64135	36.6943
03	3.345813	11.53729	13.98717	48.2316
04	2.492548	8.59499	16.47971	56.8266
05	2.261533	7.79839	18.74125	64.6250
<b>06</b>	<b>1.821669</b>	<b>6.28162</b>	<b>20.56292</b>	<b>70.9066</b>
07	1.534269	5.29058	22.09718	76.1972
08	1.165009	4.01727	23.26219	80.2145
09	1.070106	3.69002	24.33230	83.9045
10	1.005339	3.46669	25.33764	87.3712
11	0.895838	3.08910	26.23348	90.4603
12	0.749333	2.58391	26.98281	93.0442
13	0.589012	2.03108	27.57182	95.0752
14	0.347535	1.19840	27.91936	96.2736
15	0.292431	1.00838	28.21179	97.2820
16	0.249108	0.85899	28.46089	98.1410
17	0.153245	0.52843	28.61414	98.6694
18	0.141028	0.48630	28.75517	99.1558
19	0.090867	0.31333	28.84603	99.4691
20	0.056972	0.19646	28.90301	99.6655
21	0.046176	0.15923	28.94918	99.8248
22	0.032932	0.11356	28.98211	99.9383
23	0.015209	0.05245	28.99732	99.9908
24	0.002099	0.00724	28.99942	99.9980
25	0.000515	0.00178	28.99994	99.9998
26	0.000058	0.00020	29.00000	100.000
27	0.000005	0.00002	29.00000	100.000
28	0.000000	0.00000	29.00000	100.000

Based on the results, we can state that Factor 1 explains 21.85% of variability, Factor 2 explains 14.85% and Factor 3 explains approximately 11.54% of variability within the original variables. Each other factor gradually explains the smaller and smaller proportion of variability that is not explained by the previous factors. If we consider the Kaiser rule, we would consider those

principal components whose value of the number is greater than 1. In this case, the number of principal components would be 10. If we use the rule that it requires, so that the principal components account for at least 70% of the total scatter, resulting count would be 6. When determining the number of principal components, we can also apply a Scree plot, where we identify the break point, taking into account the principal components in this break. Based on Scree plot, we identify that the number of principal components would be 8 and the break point explained 4.0173% of total scattering.

As mentioned in the methodological section of the paper, there are several ways to determine the number of principal components. In this paper, we decided to apply the second option, and to work with 6 principal components within research, which together account for 70.9066% of total variance.

The next step of the analysis was to determine the factor coordinates of variables based on correlation of variables with factors after Varimax method rotation. The high absolute value of the coefficient (the high-lighted variables) means that this variable is significantly represented in this factor (see Table 3).

Tab. 3 – Factor loadings table. Source: own research

Indicators (variables)	Factor Loadings (factor scores); Extraction: Principal components Method Varimax raw; Marked loadings are >.700000					
	Factor 1	Factor 2	Factor 3	Factor 4	Factor 5	Factor 6
Quick Ratio	<b>0.979851</b>	0.025686	-0.024909	-0.082345	0.010889	0.104503
Current Liquidity	<b>0.975163</b>	0.065423	-0.018054	-0.076047	0.013929	0.129583
Total Liquidity	<b>0.937111</b>	0.032864	0.019195	0.267729	0.028604	0.123177
Net Cash	0.202578	-0.044428	-0.027207	0.215573	-0.034996	-0.142910
Net Cash Assets	0.135473	0.677110	0.008292	0.285651	-0.021196	-0.012858
Net Cash Assets	0.135009	0.430191	0.075666	<b>0.822123</b>	0.011610	-0.001673
Business Safety Indicator	0.262563	0.227854	0.040928	0.176661	-0.012126	<b>0.801207</b>
Days Rec. Outstanding	-0.075493	0.018173	<b>0.924814</b>	0.006560	0.002750	0.029852
Days Inv. Outstanding	0.060850	-0.083025	0.240964	<b>0.927709</b>	0.044160	0.001463
Days Pay. Outstanding	0.028513	-0.089170	<b>0.861234</b>	-0.000931	-0.020588	-0.331813
Turnover Money Period	-0.016553	0.036455	-0.290371	<b>0.754543</b>	0.058970	0.369068
Assets Turnover Ratio	-0.255005	0.132521	-0.522747	-0.107057	0.086479	-0.090991
Turnover of LT Assets	-0.112055	<b>0.769866</b>	-0.171090	-0.025259	0.010463	-0.030791
Total Indebtedness	-0.172794	-0.024642	0.078319	-0.129203	-0.068196	<b>-0.938290</b>
Rate of financial independence	0.172795	0.024643	-0.078318	0.129204	0.068196	<b>0.938290</b>
Debt to Equity Ratio	-0.082875	-0.081827	0.093635	-0.067569	-0.557052	0.027288
Equity to Debt Ratio	<b>0.887950</b>	-0.017396	0.015437	0.338221	0.047296	0.130184
Degree of Over-Capitalization	0.086144	<b>0.899419</b>	0.008277	0.005397	0.015248	0.119352
Degree of Under-Capitalization	-0.026666	<b>0.944283</b>	0.031475	0.019917	0.006639	0.024635
Interest Coverage Ratio	0.038016	0.025961	-0.490033	0.142156	-0.349017	-0.025374
Interest Load	-0.019713	0.141570	0.072424	-0.041559	-0.030974	0.156996
Loan Indebtedness	-0.205574	0.419281	0.056911	-0.000788	0.143452	-0.004202
Loan Repayment Period	-0.163533	<b>0.721935</b>	-0.162622	-0.013075	0.070353	0.000319
Stability Indicator	0.203114	<b>0.882028</b>	0.007863	0.065192	0.021878	0.133015
Return on Assets	-0.085400	0.021483	-0.489730	0.070706	-0.067793	0.638787
Return on Equity	-0.037222	-0.021294	0.015876	-0.036421	<b>-0.952356</b>	0.006745
Return on Sales	0.212323	-0.027112	-0.215313	<b>0.819760</b>	-0.015343	0.378645
Return on Costs	0.118945	-0.037902	-0.434315	0.518658	-0.131702	0.243623
Return on Investment	-0.034556	-0.022128	-0.055866	-0.003708	<b>-0.893693</b>	-0.131776
<b>Exploration Variance</b>	<b>4.068224</b>	<b>4.538300</b>	<b>2.827099</b>	<b>3.488010</b>	<b>2.215280</b>	<b>3.426348</b>
<b>Principal Total</b>	<b>0.140284</b>	<b>0.156493</b>	<b>0.097486</b>	<b>0.120276</b>	<b>0.076389</b>	<b>0.118150</b>

Table 3 shows that all Liquidity Ratios and indicator of Equity to Debt Ratio are directly related to the first component (factor). The second component directly correlates to the most indicators, namely the Turnover of Non-Proprietary Assets, the Degree of Over-Capitalization, the Degree

of Under-Capitalization, the Repayment Period, and the Stability indicator. The third factor achieved positive correlations with the indicators of the Days Payable Outstanding and the Days Receivable Outstanding. The fourth component had shown direct correlations with Net Working Capital, the Days Inventory Outstanding, The Days of Payment Turnover, and Return on Sales. The fifth component confirmed negative dependency for the Return on Equity and the Return on Capital Invested. The significant positive direct correlation of the sixth factor was quantified with the Business Safety Indicator and the Equity Ratio. On the contrary, indirect negative dependence was confirmed in the case of Debt-to-Assets Ratio.

Based on the analysis of the principal components, it was created a Component Score figure, so called performance portfolio of TAs (see Figure 2). The first two principal factors were applied in the construction of the figure. The principal Factor 1 included indicators such as the Cash Ratio, the Current Liquidity, the Total Liquidity and the Equity to Debt Ratio. The principal Factor 2 correlated with the Turnover of non-proprietary Assets, the Degree of Over-Capitalization, the Degree of Under Capitalization, the Repayment Period, and the Stability indicator. Based on the Component Score figure, we can monitor the position of the TAs, as well as their interdependencies. TAs located further away from the coordinate system may be termed as extremes. The position of these enterprises was determined by significantly different financial indicators in both positive and negative terms. In this case, it was the CORADO travel agency, Ltd., HYDROTOUR, travel agency, Inc., PHARMAEDUCA, Ltd., and Travelco Ltd. On the contrary, TAs located as close as possible to the coordinate system can be considered the most typical for a given industry, group of monitored objects.

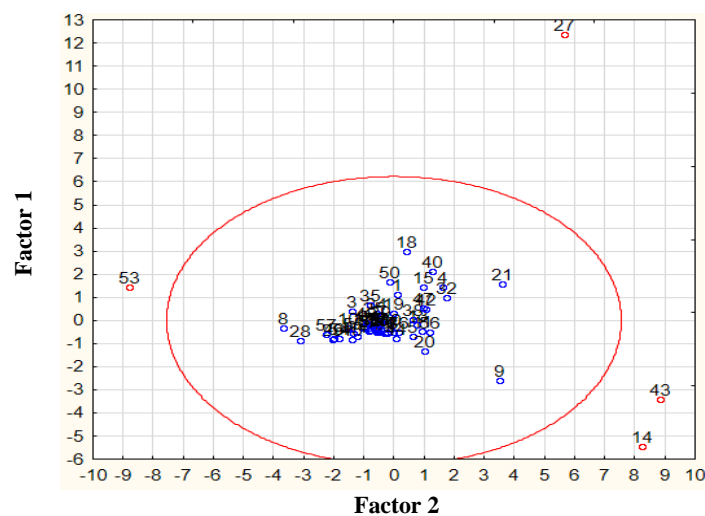

Fig. 2 – Component Score figure. Source: own research

For the compilation of the resulting performance portfolio of TAs, we analysed the individual quadrants of the component score figure (identification of TA's – see Table 1). In Quadrant A there were enterprises that achieved very good results at Principal Factor 2 and worse results for Principal Factor 1. In this quadrant were located 6 TAs in total (TA 03, TA 19, TA 25, TA 34, TA 35 and TA 50). In the Quadrant B there were 11 TAs (TA 01, TA 04, TA 15, TA 18, TA 21, TA 27, TA 32, TA 38, TA 40, TA 42 and TA 47), which achieved very good results at both principal factors. The Component Score figure confirmed that this quadrant can be considered the best. The third Quadrant C, characterized as the worst, to due the worse results for both principal factors, there were up to 30 TAs (TA 02, TA 06, TA 07, TA 08, TA 10, TA 12, TA 16, TA 17, TA 22, TA 23, TA 24, TA 26, TA 28, TA 29, TA 30, TA 31, TA 33, TA 37, TA 39, TA 41, TA 45, TA 46, TA 48, TA 49, TA 51, TA 52, TA 53, TA 54, TA 55 and TA 57). In the Quadrant D of the Component Score figure, the TAs were placed, which achieved

very good results in the Principal Factor 1, but the worse results in the Principal Factor 2. In total there were 10 TAs (TA 05, TA 09, TA 11, TA 13, TA 14, TA 20, TA 36, TA 43, TA 44 and TA 56).

In the context of these results, we can state that in order to increase performance, TAs should focus primarily on improving the principal Factor 1 and principal Factor 2 indicators, depending on which factor had worse results. For enterprises located in Quadrant B, where both principal factors have been quantified to a very good level, the level of performance still needs to be maintained.

The second modern method evaluating the average performance of TAs during the period of 2013-2017 was CWM of performance. The development of the performance for the years analysed on average, in order to create the performance portfolio of the selected TAs, is shown in Figure 3 below (identification of TA's – see Table 1).

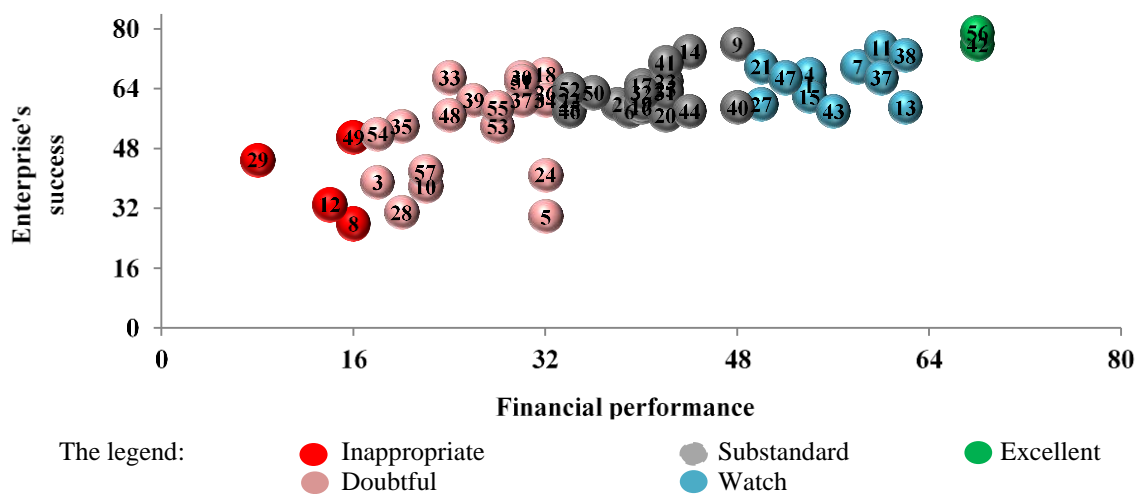

Fig. 3 – Average performance of travel agencies based on CWM. Source: own research

Based on the above chart we can conclude several facts. On average, travel agencies were located in the range of all performance fields from "inappropriate" to "excellent". Colour scaling by points made it possible to better identify overall position of individual enterprises in this matrix. The results showed that most enterprises, (exactly 20), were situated in the "substandard" performance field, while 19 enterprises were placed in the "doubtful" performance field. Furthermore, significantly less enterprises (exactly 12) were included into the "watch" performance field.

Over the years analysed, the following TAs were identified as non-performing ("inappropriate performance field") - CK AZAD, Ltd., CK TRGOTURS, Ltd., INTERBUS, Ltd., SKI TRAVEL – PROEVENTS, Ltd. On the contrary, the following travel agencies can be considered as the best performing enterprises ("excellent" performance field) based on findings - Pelicantravel.com, Ltd., VOX, Ltd. Of course, in order to evaluate certain enterprise within competitive environment, this model can be modified and financial indicators as well as predictive models can be further analysed to identify the strengths and weaknesses. The overall average performance of the 57 TAs was located in the "substandard" performance field over the period analysed, with a financial performance score of 38 points and future success score of 59 points. It follows that the current financial position of enterprises achieved below-average level. However, in the future is expected improvement based on the predictive models' results.

In order to meet the main objective and to find out the answer to RQ, we have focused on revealing the concordance rate of order of the TAs performance by applying two selected

methods, the PCA and the CWM. To determine the concordance rate of order, we have used Spearman's rank order correlation. In the following Table 4, we compared the ranking of individual TAs to their performance in terms of compared financial instruments.

Tab. 4 – Travel agencies performance ranking. Source: own research

Final order	CWM	PCA	Final order	CWM	PCA	Final order	CWM	PCA
01.	TA 56	TA 27	20.	TA 25	TA 36	39.	TA 46	TA 17
02.	<b>TA 42</b>	TA 21	21.	TA 17	TA 44	40.	TA 33	TA 02
03.	TA 11	TA 40	22.	TA 31	TA 03	41.	TA 37	TA 31
04.	TA 38	TA 18	23.	TA 32	TA 25	42.	TA 39	TA 06
05.	TA 07	TA 04	24.	TA 44	TA 34	43.	TA 55	TA 26
06.	TA 36	TA 32	25.	TA 18	TA 35	44.	TA 53	TA 33
07.	TA 09	TA 15	26.	<b>TA 19</b>	TA 50	45.	TA 48	TA 52
08.	TA 04	<b>TA 42</b>	27.	TA 16	<b>TA 19</b>	46.	TA 35	TA 12
09.	TA 13	TA 47	28.	TA 20	TA 07	47.	TA 24	TA 22
10.	TA 21	<b>TA 01</b>	29.	TA 50	TA 39	48.	TA 54	TA 10
11.	<b>TA 01</b>	TA 38	30.	TA 02	TA 30	49.	TA 49	TA 55
12.	TA 47	TA 43	31.	TA 52	TA 23	50.	TA 57	TA 24
13.	<b>TA 14</b>	<b>TA 14</b>	32.	TA 06	TA 16	51.	TA 05	TA 45
14.	TA 15	TA 09	33.	TA 30	TA 37	52.	TA 10	TA 57
15.	TA 43	TA 56	34.	<b>TA 51</b>	TA 48	53.	TA 03	TA 54
16.	TA 41	TA 13	35.	TA 22	<b>TA 51</b>	54.	<b>TA 29</b>	TA 46
17.	TA 27	TA 11	36.	TA 26	TA 53	55.	<b>TA 28</b>	<b>TA 29</b>
18.	TA 23	TA 05	37.	TA 34	TA 49	56.	TA 12	<b>TA 28</b>
19.	TA 40	TA 20	38.	TA 45	TA 41	57.	<b>TA 08</b>	<b>TA 08</b>

Based on the results, we have quantified the identical concordance rate in performance in the case of two TAs - TA 08 (AZAD, Ltd.) and TA 14 (CORADO, Ltd.). A total of 4 TAs (TA 01, TA 28, TA 29 and TA 51) were identified as having the lowest order difference (only 1 place). On the contrary, the highest order difference was identified for TA 05 (CASSOFIN, Inc.). According to results in the comparison of the PCA method and the CWM, it can be stated that the best performing enterprise was not determined clearly. However, as the worst performing was indicated TA 08 (AZAD, Ltd.) in the case of both methods. We have used the Spearman's rank order correlation to confirm the compliance/noncompliance of concordance rate of order. Spearman's rank order correlation achieved value of 0.7459; which indicates a strong correlation, but it is not a complete match of order. Based on the research findings, we can answer positively to the RQ. In our opinion, the performance portfolio of TAs by applying a multidimensional PCA method provide identical results compared to the method of CWM.

## 5 DISCUSSION AND CONCLUSION

The research paper was focused on assessing the financial performance of selected TAs based on the multidimensional PCA method and at the same time using method of CWM in order to create performance portfolio of enterprises for the period of 2013 – 2017. Furthermore, the research was aimed at revealing the concordance rate of order within the selected enterprises based on above-mentioned methods.

The results showed that the best performing TA was Pelicantravel.com, Ltd.; on the other hand, the worst performing was quantified TA AZAD, Ltd. By the PCA application, 11 TAs were classified as well-performing, while 30 enterprises were identified as non-performing. In contrast to PCA, in the case of CWM application, only 2 TAs were classified as well-performing, while 4 were identified as non-performing. Spearman's rank-order correlation confirmed identical concordance rate of order in performance rankings, and we can state that

the performance portfolio of TAs by applying a multidimensional PCA method provide identical results compared to the method of CWM, so RQ was confirmed.

In addition to enterprise performance assessment, the article offers useful practical implications. By applying the PCA method, 29 interdependent variables (financial ratios) were reduced to 6 principal factors (correlation independent components), which together account for up to 70.9066% of total variance, as well as we identified key performance indicators. In our opinion, presented findings can help in the process of quantifying the performance of TAs. To conclude, it is important to emphasize that the application of the methods of PCA and CWM has made it possible to create a performance portfolio of TAs and thus to create a performance ranking of the selected research sample. The presented performance evaluation methodology can be implemented in any business sector in financial practice.

Based on literature review, we can state that no authors applied the PCA method and the CWM for enterprise performance assessment at the same time, so we consider this research for useful in theoretical, as well as practical point of view. Traditionally, authors implemented only one of presented methods. For example, Li & Zhang (2011) quantified enterprise performance through financial indicators using the PCA method. Sofrankova, Horvathova, Kiselakova & Matkova (2016) applied PCA methods in order to identify key indicators of enterprise performance based on secondary data from the financial statements of the 200 selected food enterprises. Using the method of PCA, authors identified two principal components, on which the performance of the enterprise depends. Davidescu, Vass Paul, Gogonea & Zaharia (2015) analysed performance through multidimensional analysis techniques, including the Multiway Principal Components Analysis. The method of CWM as a performance evaluation tool was used in the study of Kiselakova, Horvathova, Sofrankova & Soltes (2015). Authors devoted to modification of this model and extended the original two-dimensional CWM about the third dimension - the dimension of risk - and created a new model of performance evaluation, so-called Enterprise Risk Model.

The issues performance and growth, as well as the competitive features and success factors, are examined in all economic areas (Stefko, Jencova, Litavcova & Vasanicova, 2017). We agree with the above-mentioned authors who claim that using these methods help to classify enterprises into performance fields. In our opinion, it is necessary to include several methods for enterprise performance assessment. Of course, research paper has several limitations. The research sample is limited and the analysed period is too short because of data availability. For future research, all TAs operated in sector should be analysed. Furthermore, another financial methods and statistical tools should be applied for purpose of benchmarking market segment.

## **Acknowledgement**

Scientific Paper was elaborated within the framework of the project VEGA No. 1/0279/19 Model approaches to increase performance and competitiveness in the European area in the context of sustainable development.

## **References**

Aguiar-Quintana, T., Moreno-Gil, S., & Picazo-Peral, P. (2016). How could traditional travel agencies improve their competitiveness and survive? A qualitative study in Spain. *Tourism Management Perspectives*, 20, 98-108. doi: 10.1016/j.tmp.2016.07.011



- Al-Eideha, B. M. (2016). *Statistical Methods for Business Data Analysis Using SPSS*. Riga: Scholars's Press.
- Benasseni, J. (2018). A correction of approximations used in sensitivity study of principal component analysis. *Computational Statistics*, 33(4), 1939-1955. doi: 10.1007/s00180-017-0790-7
- Davidescu, A. A. M., Vass Paul, A. M., Gogonea, R. M., & Zaharia, M. (2015). Evaluating Romanian Eco-Innovation Performances in European Context. *Sustainability*, 7(9), 12723-12757. doi: 10.3390/su70912723
- Del Alonso-Almeida, M. M., Bagur-Femenias, L., & Llach, J. (2017). The adoption of quality management practices and their impact on business performance in small service companies. *Service Business*, 9(1), 57-75. doi: 10.1007/s11628-013-0218-6
- Fan, J., Xue, L., & Yao, J. (2017). Sufficient forecasting using factor models. *Journal of Econometrics*, 201(2), 292-306. doi: 10.1016/j.jeconom.2017.08.009
- Fan, J., Liao, Y., & Mincheva, M. (2013). Large covariance estimation by thresholding principal orthogonal complements. *Journal of the Royal Statistical Society*, 75(4), 603-680. doi: 10.1111/rssb.12016
- Ghosh, S. (2019). Uncertainty, economic growth its impact on tourism, some country experiences. *Asia Pacific Journal of Tourism Research*, 24(1), 83-107. doi: 10.1080/10941665.2018.1542324
- Hebak, P., Hustopecky, J., Jarosova, E., & Pecakova, I. (2010). *Multivariate statistical methods*. Prague: Inforamtorium.
- Holjevac, I. A., & Basan, L. (2009). Internal marketing factors and the performance of travel agencies. *Tourism and Hospitality Management-Croatia*, 15(1), 37-48. Retrieved from <https://hrcak.srce.hr/181015>
- Horvathova, J., & Mokrisova, M. (2014). Diagnostics of business performance with application of modern methods of financial performance evaluation. *Economics, Management, Innovation*, 6(3), 46-60. Retrieved from [http://emijournal.cz/?page\\_id=169](http://emijournal.cz/?page_id=169)
- Horvathova, J., Mokrisova, M., Suhanyiova, A., & Suhayi, L. (2015). Selection of Key Performance Indicators of Chosen Industry and their Application in Formation of Creditworthy Model. *Procedia Economics and Finance*, 34, 360-367. doi: 10.1016/S2212-5671(15)01641-X
- Horvathova, J., & Sofrankova, B. (2012). Evaluation of the financial performance and the success of the business. *International Scientific Correspondence Conference*. Retrieved from [pulib.sk/web/kniznica/elpub/dokument/Kotulic18/subor/horvathova.pdf](http://pulib.sk/web/kniznica/elpub/dokument/Kotulic18/subor/horvathova.pdf)
- Huttmanova, E., & Valentiny, T. (2019). Assessment of the Economic Pillar and Environmental Pillar of Sustainable Development in the European Union. *European Journal of Sustainable Development*, 8(2), 289-298. doi: 10.14207/ejsd.2019.v8n2p289
- Hyranek, E., Grell, M., Nagy, L., & Durinova, I. (2018). The Economic-mathematical Nature of the HGN Model Concept as a Tool for Measuring Performance of Enterprises. *Journal of Economics*, 66(3), 309-325. Retrieved from <https://www.ceeol.com/search/article-detail?id=685080>
- Jiang, L., Li, Y., & Cai, L. P. (2018). Evaluation of enterprise economic performance based on principal component analysis. *Journal of Interdisciplinary Mathematics*, 21(5), 1309-1314. doi: 10.1080/09720502.2018.1498004

- Kajzar, P. (2018). A tourism trends and development of selected economic indicators in the Moravian - Silesian region between 2006 - 2016. *Acta Oeconomica Universitatis Selye*, 7(1), 46-57. Retrieved from <https://www.ceeol.com/search/article-detail?id=708835>
- Kiselakova, D., Horvathova, J., Sofrankova, B., & Soltes, M. (2015). Analysis of Risks and Their Impact on Enterprise Performance by Creating Enterprise Risk Model. *Polish Journal of Management Studies*, 11(2), 50-61. Retrieved from <https://pjms.zim.pcz.pl/resources/html/article/details?id=167196>
- Kocmanova, A., Docekalova, M. P., Lace, N., & Nemecek, P. (2017). Environmental, Social, Governance and Economics Model of a Company's Sustainable Development as a base for Investment Decision Making. *Proceedings of The 21st World Multi-Conference on Systemics, Cybernetics and Informatics (WMSCI 2017)*, 7-12. Retrieved from <http://www.iiis.org/CDs2017/CD2017Summer/papers/SA990UE.pdf>
- Kozena, M., & Jelinkova, L. (2014). Specifics of Performance Measurement and Management Manufacturing Company. *International Multidisciplinary Scientific Conference on Social Sciences and Arts SGEM2014*, 2(2014), 655-662. doi: 10.5593/sgemsocial2014/B22/S6.083
- Kral, P., Kanderova, M., Kascakova, A., Nedelova, G. & Bojdova, V. (2009). Multidimensional statistical methods focusing on solving problems of economic practice. Banská Bystrica: Matej Bel University in Banská Bystrica.
- Kristjanpoller, W., & Minutolo, M. C. (2018). A hybrid volatility forecasting framework integrating GARCH, artificial neural network, technical analysis and principal components analysis. *Expert Systems with Applications*, 109(2018), 1-11. doi: 10.1016/j.eswa.2018.05.011
- Li, Y, C., & Zhang, Q. (2011). The Application of Principal Component Analysis on Financial Analysis in Real Estate Listed Company. *Procedia Engineering: International Conference on Advanced in Control Engineering and Information Science*, 15, 4499-4503. doi: 10.1016/j.proeng.2011.08.845
- Lin, T-Ch. (2011). How the environment affects travel agency performance. *African Journal of Business Management*, 5(3), 960-966. doi: 10.5897/AJBM10.857
- Misoc, I. (2018). Direct research on the performance assessment methods used in Romanian travel agencies in order to evaluate the travel agents' performance. *Proceedings of the 12<sup>th</sup> International management conference*, 673-682. Retrieved from [http://conferinta.management.ase.ro/archives/2018/pdf/4\\_8.pdf](http://conferinta.management.ase.ro/archives/2018/pdf/4_8.pdf)
- Nobre, J., & Neves, R. F. (2019). Combining Principal Component Analysis, Discrete Wavelet Transform and XGBoost to trade in the financial markets. *Expert Systems with Applications*, 125, 181-194. doi: 10.1016/j.eswa.2019.01.083
- Onuferova, E., & Cabinova, V. (2018). Enterprise Performance Analysis of the Selected Service Sector by Applying Modern Methods with an Emphasis on the Creation and Application of the Modified Creditworthy Model (MCWM). *Journal of Tourism and Services*, 9(17), 1-26. doi: 10.29036/jots.v9i17.74
- Robu, I. B., & Istrate, C. (2015). The analysis of the principal components of the financial reporting in the case of Romanian listed companies. *Procedia Economics and Finance*, 20, 553–561. doi: 10.1016/S2212-5671(15)00108-2
- SACKA (2019). *Slovak Association of Tour Operators and Travel Agents*. Retrieved from <https://www.sacka.eu/en/>

- Sharma, J. K. (2007). *Business Statistics*. New Delhi: Dorling Kindersley.
- Simionescu, L., N., & Dumitrescu, D. (2018). Empirical study towards business social responsibility practices and company financial performance. Evidence for company listed on the Bucharest stock Exchange. *Sustainability*, 10(9), 3-23. doi: 10.3390/su10093141
- Sofrankova, B., Horvathova, J., Kiselakova, D., & Matkova, S. (2016). Application of Selected Statistical Methods in the Issue of Enterprise Financial Performance. *Proceedings of the 28th International business information management association conference IBIMA*, 1336-1345. Norristown: International business information management association.
- Sofrankova, B., Kiselakova, D., & Horvathova, J. (2017). Actual Questions of Risk Management in Models Affecting Enterprise Performance. *Journal of Economics*, 65(7), 644-667. Retrieved from [www.sav.sk/journals/uploads/0907134607%2017%20Sofrankova%20+%20RS.pdf](http://www.sav.sk/journals/uploads/0907134607%2017%20Sofrankova%20+%20RS.pdf)
- Sofronov, B. (2018). The Development of the Travel and Tourism Industry in the World. *Annals of Spiru Haret University, Economic Series*. 18(4), 123-137. doi: 10.26458/1847
- Stefko, R., Jencova, S., Litavcova, E., & Vasanicova, P. (2017). Management and funding of the healthcare system. *Polish Journal of Management Studies*, 16(2), 266-277. doi: 10.17512/pjms.2017.16.2.23
- Vochozka, M., Rowland, Z., & Vrbka, J. (2016). Financial analysis of an average transport company in the Czech Republic. *Our sea*, 63(3), 227-236. doi: 10.17818/NM/2016/SI28

## Contact information

### **Mgr. Erika Onuferová**

University of Prešov in Prešov, Faculty of Management  
Konštantínova 16, 080 01 Prešov  
E-mail: [erika.onuferova@smail.unipo.sk](mailto:erika.onuferova@smail.unipo.sk)  
ORCID: 0000-0001-8529-8843

### **Mgr. Veronika Čabinová**

University of Prešov in Prešov, Faculty of Management  
Konštantínova 16, 08001 Prešov, Slovakia  
E-mail: [veronika.cabinova@smail.unipo.sk](mailto:veronika.cabinova@smail.unipo.sk)  
ORCID: 0000-0003-4367-3590

### **Ing. Peter Gallo, PhD.**

University of Prešov in Prešov, Faculty of Management  
Konštantínova 16, 08001 Prešov, Slovakia  
E-mail: [peter.gallo.1@unipo.sk](mailto:peter.gallo.1@unipo.sk)  
ORCID: 0000-0001-5193-1997

### **Ing. Mária Matijová**

University of Prešov in Prešov, Faculty of Management  
Konštantínova 16, 08001 Prešov, Slovakia  
E-mail: [matijovam.kf@gmail.com](mailto:matijovam.kf@gmail.com)  
ORCID: 0000-0001-9329-3209

**Ing. Nikola Sikorová Jurová, MBA**  
University of Prešov in Prešov, Faculty of Management  
Konštantínova 16, 08001 Prešov, Slovakia  
E-mail: nikola.sikorova@gmail.com  
ORCID: 0000-0003-2584-849X

doi: 10.7441/dokbat.2019.082

# MENTEE-MENTOR COOPERATION, MENTEE BENEFIT AND ORGANIZATIONAL PERFORMANCE: A LITERATURE REVIEW

*Victor Kwarteng Owusu, Aleš Gregar*

## **Abstract**

Different companies use different techniques to develop talents and highly skilled labour. Mentoring program has been a popular technique amongst organizations in supporting training and development of career among new recruits, potential business managers, and graduates. The aim of this research is to examine the effect of mentoring on organizational performance, and explore the benefits derived by mentees. The current study was based wholly on qualitative analysis, (Document analysis) which centres on scientific manuscripts obtained from databases such as google scholar, WoS, and SCOPUS. The theme for the study was gathered from organizational theories and theories of mentoring. A conceptual framework was deduced from literature to elaborate on the concept of mentoring, organizational performance and mentee benefits. Some practical implications for this study are: (i) organizations should include mentoring as part of regular training and development schemes, and (ii) new employees should be assigned to more experienced employees. This paper is also to broaden the scope of knowledge on mentoring and organizational performance.

*Keywords: mentoring, mentee benefits, organizational performance, organizational benefits, cooperation*

## **1 INTRODUCTION**

In order to ensure service quality, effectiveness and responsiveness in an organization, there is the need to develop the human resource to face the ever-changing and sophisticated business environment of these organizations. For businesses or organizations to anticipate long term existence, they must focus on practices and strategies to empower their employees by providing proper training and development programs. Mentoring is a type of training considered as a scope of talent management, which is widely based on the premise of the development of special skills that improve on the organization as well as the individual. Moreover, mentoring assist mentees to develop new processes of thinking which aid them to build on their careers by developing a strong relationship with more experienced and knowledgeable individuals (Klasen & Clutterbuck, 2012).

While authors (Garvey, Strokes & Megginson, 2010; Jackson, 2008; Parsloe & Leedham, 2009) have worked on mentoring in the past, there is still the need to uncover the real chemistry especially between mentor and mentee and the benefits derived by the mentee and the organization. This paper, therefore, examines the influence of a mentor on a mentee and the benefits obtained by both the employee and the organization. Various techniques are adopted by different companies to build talents to enhance their workforce. As explained by Crisp and Cruz (2009), mentoring is one of the most popular techniques for supporting the training and development among new recruits, potential business managers and graduates. Clutterbuck (2014) also posits that mentoring symbolizes openness to new ideas, enthusiasm, and willingness to listen and encourage people to become involved in achieving new job experience. Therefore, the schemes of mentoring can be offered at a comparatively low cost making them specifically fitting talent management tools for organizations in current competitive business environment. Nevertheless, lack of understanding of the meaning of mentoring in

organizational context can create difficulties and can affect the development activities of an organization. According to Rekar-Munro (2009), human capital can be equipped with knowledge, skills, and capabilities through mentoring, the individual assigned to perform that particular job can execute it thoroughly, efficiently and effectively. Mentoring helps to improve on performance and the output of the associated employees which leads to increase in quality of service and ultimately enhances the financial circumstances of their organization (Christensen & Rog, 2008). Mentoring can also build organizational staff to enhance employee performance, strengths, satisfaction, and quality of customer services, supervision and overall cost for each employee (Bailey & Kurland, 1999). Therefore, investment in mentoring has significant effect on the performance of the employees and their organizations. According to Armstrong (2009) employees' knowledge, skills, positive attitudes, abilities and confidence enhance their performance. The improvement of performance is becoming obligatory for the organizations to be able to keep pace with the ever-changing business environment and fulfils the gap between existing skills and required knowledge to operate the business.

The main aim of this study is to review mentor-mentee relationship, mentee benefits, organizational benefits and organizational performance in a service-based organization. The remaining sessions of the write-up areas proceeded with; theoretical foundation of the theme under study, definition of mentoring, conceptual model and proposition development, the study method, discussions, limitations and finally, ended with the conclusion and future research direction.

## **2 THEORETICAL FOUNDATION**

Training and development of employees are very important in order to engender a team of outstanding working professionals. For organizations to achieve competitive benefits, by using their resources effectively and efficiently, they have to devise an appropriate strategy to optimize service excellence and innovation in organization (Knight & Cavusgil, 2004). Mentoring is a kind of training and development that focuses on the individual's motivation, morale, and output. Mentoring generally, explains the relationship between less experienced and more experience thus mentor and mentee. According to Kopp and Hinkle (2006), mentoring is viewed as one-on-one bilateral and continuous relationship between supervisory adults and subordinates which help to enhance professional development. The concept of mentoring is a human endeavour focusing on learning and development activities of an individual in an organization (Ehrich, Hansford & Tennent, 2004). Moreover, a systematic and planned function used in modifying employees' behaviour with the help of learning activities is mentoring, which also depends on programs and events that help to achieve abilities, knowledge, competences, and skills for effectiveness and efficiency (Elnaga & Imran, 2013). Mentoring is, therefore, an organized process of evolving professional understanding knowledge and skills of the people which assists them to augment organizational and discrete performance. As asserted by Ulrich (1996), companies can achieve their business objectives, overall organizational values and mission. And finally support culture of innovation through mentoring and enhancement of employees' competences.

### **2.1 Mentee and organizational benefits**

Organizations have benefited from mentor-mentee relationships, and some of them have tried to formalise these relationships as part of planned career development of employees (Ehrich, Hansford & Tennent, 2004; Chao, 2009). Furthermore, most employees expect organizations to provide avenues to meet their career and developmental needs (Lee & Bruvold, 2003). The deep interpersonal exchange that exist amongst mentorship can lead to reward towards mentee and the organization. The benefits of the can be so valuable that identification with a mentor

should be seen as a major developmental task of an early career. Some of these benefits are mentees; learn about different career paths, increase confidence and self-awareness, expand professional and personal networks, improve skill sets and gain support while you study. (Dobrow & Higgins, 2005; Hall, 2004; Brown et al., 2012). Moreover, apart from the above benefits derived by individual mentees, the organization as the main vehicle for mentorship also benefits (Klasen & Clutterbuck, 2012; St-Jean & Audet, 2012). There is enormous evidence via research that suggest that there is a link between mentee-mentoring relationship and organizational performance (Freedman, 2009; Hattingh, Coetzee & Schreuder, 2005), enhanced organizational commitment (Agarwala, 2003), revenue and profitability, market growth, employee retention, team efficiency, and service quality (Yee, Yeung & Cheng, 2010). From organizational point of view, mentoring has become a key career resource for talent management (Davis et al., 2016) and also a mechanism for educating new recruits, regarding the organizational values (Aryee, Budhwar & Chen, 2002).

### **3 DEFINITION OF MENTORING, CONCEPTUAL MODEL AND PROPOSITION DEVELOPMENT**

The process whereby an experienced employee (mentor) helps a young and inexperienced employee (mentee) in building particular skills or knowledge to improve on their personal and professional growth can be termed as mentoring. (Kahle-Piasecki, 2011). Mentoring can be one-to-one, known- judgemental associations between a mentor and mentee of which mentor takes time to encourage and support others which normally developed at the transition time in the life of the mentee and sustained for significant period of time. Mentoring contributes, support advocate or provide guidance for the realization of predetermined objectives over a specific period of time.

According to Scardamalia and Bereiter (2006), mentoring is off-line support by one person to another in making important transitions in knowledge or thinking. In other words, mentoring is support attained from one individual (mentor) to another individual (mentee) within a build-up relationship generated from regular contacts over a specific period of time. However, according to Crisp and Cruz (2009), mentoring relates to identification and nurturing of likelihood for an individual which may be long term objectives and can change but are influenced by the mentees or the learners. The learners owe both process and the aims. Feedback comes and from the learners and their mentors provide them with the assistance to have deep insights, thoughtful and intrinsic clarification.

Similarly, as implied by Eraut and Hirsh (2010) mentoring involves supporting people in identifying the needs of their own development and setting their own goals and objectives; encourage self-governing learners; allowing them to talk and advance their difficulties, reflecting back and clarifying intermittently. Helping them to reproduce their thoughts, feelings, behaviours and believes, and to observe difficulties from various perspectives; encouraging and guiding them in independent solution and analysis of their opportunities and problems; supporting the solutions of the issues by embracing an integrated approach; and enable them to become effective in decision making.

Mentoring is generally more focused on assisting the executives to determine the appropriate goals to follow and why it should be followed, and it is usually a long term relationship. It strives to build intelligence, the ability to use knowledge, skills, and experiences to new challenges and experiences to new situations and problems (Neupane, 2015). Mentoring is again an evolving and open agenda that deals with different issues. In summary mentoring is about following a career path in which training is focused on behaviours, professional and personal development. It is, however, interactive and of role modelling.

### 3.1 Perspectives of mentoring

Building the capabilities and skills of an existing and current employee is the ultimate focus of organizations on their overall cooperate strategy. According to Elnaga and Imran (2013) Organizations can be competitive only if they provide training and development and conducive learning environment by inspiring their staff. Human resource practitioners contribute great deal to the success of their organizations and by extension contribute to their goals of educating and developing their staff. Training and development have become increasingly sophisticated, therefore, it demands the application of internet technologies. Nevertheless, mentoring is seen as an important part of an effective learning strategy for organizations. Evidence abounds of the usefulness of mentoring in improving the capacities of employees, maximize motivation and confidence. Mentoring also helps employees to develop and improve their leadership skills. Employees are able to deal with challenges and complexities such as meeting sales targets, improving relationships, making informed decisions and team building (Stone, 2007). Mentoring can improve on overall communication strategy of the organization, organizations can increase their capacity through the culture of mentoring. The term mentoring is has gained significant prominence in current world of business. Myriad of reasons can be attributed to mentoring terminology, but the net effect is that it pinpoints the tangible significance of the business aspect of the organization. A business becomes more profitable and increases productivity with increase in investment in time and money. The onus lies on the mentor to prepare the mentee to adjust to good morals, attitudes, and essential skills require to perform within the confines of the success parameters instituted by the organization. Therefore, the charge should be made clear within the given timelines to achieve its intended goals. According to Clutterbuck (2014), mentoring focuses on interpersonal and conversations, it surpasses largely on common work life. This presupposes that mentoring can be more focused, more philosophical on attitudes than a particular skill.

### 3.2 Organizational significance of mentoring

To exchange information amongst experienced and inexperienced employees that can assist in adapting to workplace culture and environment, organizations usually employ mentoring, this enhances the mentees' understanding of organizational goals and objectives (Alred, 2014). Mentors can be used by businesses to develop their employee's specific career paths. The main significances of mentoring are; retention, personal development, and team efficiency.

**Retention:** In organizational level mentoring provides various forms of advantages, it builds on employee loyalty (Manzoor, 2012). When experienced professionals help in shaping the career path of employees and provide them with opportunities, then they feel a higher sense of loyalty and connection to the business. The employee feels comfortable with their seniors and even management and helps them to be part of the open communication that helps to improve on the positive work experience. That helps to enhance employees' retention within the organization (Sandhya & Kumar, 2011). Organizations therefore, save money on recruitment, selection, and training of new recruits.

**Personal improvement:** Fewer experienced professionals receive knowledge, skills, and expertise from the more experienced professionals to develop their capacities. Consequently, their professional efficiencies, productivity, and performance are enhanced. Moreover, mentoring helps to provide guidance and direction for the employees along their career path. This helps the individual employees to be well conversant to meet the expectations of their organizations (Chao, 2007). Mentoring basically, helps to reduce frustrations among mentees the border-line of confidential interactions and enhance individual work satisfaction. And improve on ultimate benefits of the organization.



**Team competence:** According to Mathews (2003) mentoring enhances team efficiency, departmental function, and the entire organizational performance. It serves as the procedure to identify strength and weakness of individual employees. Managers should draw a clear path for employees to follow by articulating main goals and objectives. Managers must also provide feedback to the employees frequently, to aide performances they must also provide support where necessary to enhance teamwork. More experienced professionals provide support to young professionals to develop them to the organizational requirement. The consistent relationship is developed among mentors and mentees generally last for a whole career life of a mentee within an organization and consequently, acquiring skills, knowledge, and opinions, (Terrion & Leonard, 2007). Moreover, mentoring within organization helps to enhance morale and the companionship thereby leading to team building concepts and activities.

### **3.3 Employee performance management**

Periodic performance assessment forms the basis of performance management. Performance management serves as the process of which deals with employees in a way to provide positive effects on their thinking and behaviour in order to achieve expected level of performance. Managers must express positive behaviour related to performance; the utterances or behaviours of employees influence their associates (Hareli & Rafaeli, 2008). The behaviour exhibited by employees within an organization originates from lack of complete understanding and resistance to change of what is projected. The involvement of an employee must be achieved when possible for performance improvement; there is no one better than he who is constantly on the job as far as the inner workings of the organization is concerned (Herzberg, 2008). The employees must be aware of the expectations of their assignments, the assessment and the standard procedure for the assessment of their output. Employee management must be in touch with each and every employee to whip them in line with regular counselling, coaching, regular feedback and training are essential rudiments to put wayward employees in line. According to Osabiya (2015), maintaining effective and efficient performance of an employee depends on the attention of the management. Certain organizations use performance management for their assessment; performance review or performance appraisal or performance evaluation. Finally, the management of performance is the art and science to positively affect the behaviour and thinking to achieve the expected level of performance. It is also a basic technique that is integrated into everyday behaviours of the managers; to evaluate, identifying, and resolving the issues of employee performance.

The present study is based on the assumption that mentoring is a relevant tool for the improvement of employee performance and other benefits derived by the organization. Mentoring helps mentee to acquire certain benefits such as; skills, knowledge, ability, positive behaviours, confidence and personal and professional development. It equally provides certain benefits to the organization as a whole, such as; increase service or product quality, employee retention, team efficiency, high achievement of revenue target, and market growth. By virtue of this review, the present study proposes the following hypotheses and a conceptual model (see Figure 1).

*H1: Mentoring has a direct effect on organizational performance in a service-based organization.*

*H2: Organizational benefits (revenue and profitability, market growth, employee retention team efficiency service quality) positively mediate mentoring and organizational performance in a service based-organization.*

*H3: Mentee benefits (skills and knowledge, abilities, attitudes, confidence personal development) serves as a mediator between mentoring and organizational performance in a service-based organization.*

*H4: Organizational benefits (revenue and profitability, market growth, employee retention team efficiency service quality) has a direct influence on organizational performance in a service-based organization.*

*H5: Mentee benefits (skills and knowledge, abilities, attitudes, confidence personal development) has a direct influence on organizational performance in a service-based organization.*

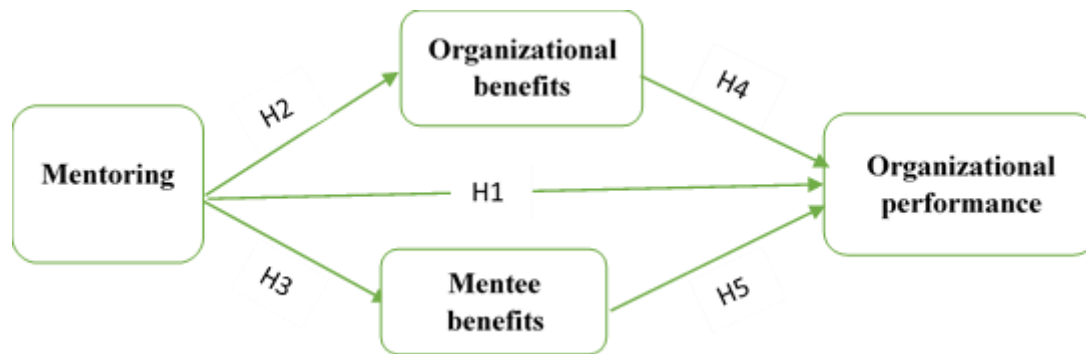

Fig. 1 – A proposed research model. Source: own research

#### 4 RESEARCH METHODOLOGY

This study is based wholly on the qualitative investigation; the researcher chose to adopt his methodology with document analysis as a research technique to achieve the main objective of the study. The document analysis centres on knowledge from scientific documents acquired from databases such as SCOPUS, WoS, ProQuest, and Google Scholar via keywords search. Theme analysis was also espoused in identifying associations across different research model, for the purpose of thorough potential relations and designs across the research domain with a realistic aim in mind (Creswell & Poth, 2017; Baskarada, 2014). Base on the understanding of the researcher, together with evidence gathered based on, secondary sources, related areas were identified and linked to the central research theory of mentoring and organizational performance accordingly. Furthermore, given the array of literature in dealing with the wider theme of mentoring, it is practical to adopt document analysis for the research due the sufficient basis it provides for study’s phenomena (Ozolina-Ozola, 2014).

The theme of the study, in particular, was frequently gathered from the strategy research pool and more precisely, from theories of mentoring and organization and the research area of mentoring and organizational performance. The ultimate goal of this study was achieved by relatively organized theme(s); of document analysis and relevant content. A conceptual framework was deduced from this understanding (Fig.1). Readers are implored by the researcher to find interest in the scholarly works Fernandez-Alles and Ramos-Rodríguez (2009) and Butler et al. (2011), since they have advocated for the document analysis as a significant tool for conducting a qualitative survey. For an interesting theme analysis readers can read the scholar papers of Huselid and Becker (2011). Under no circumstances does the researcher makes any claim concerning the in-depth documentary inquiry and the various theme there off emerging from this inquiry. However, an attempt has been made to identify closely related themes to increase the current knowledge of the existing study.

## 5 DISCUSSIONS

Mentoring has commonly been touted as beneficial to organization; much focus has not been placed on the benefits of the individual, being mentored by an experience person (mentee) and the overall benefits derived by the organization that fosters the relationship. The current study attempt to examine the benefits of mentoring at both individual and organizational level. Although, mentors by their deeds derives benefits from mentoring, the main focus of this work is on the benefits of obtained by mentee and the organization. An overview of mentoring suggest that mentoring can significantly influence organizational attraction. Nevertheless, mentoring program may be more attractive to some individuals than others.

The current study is based on the theoretical review, it is however, recommended an empirical study be conducted to ascertain the veracity or otherwise of the deductions made out of this review. For employee retention, more investment must be made to improve on the abilities, skills and broaden the knowledge of the employees. Managers and supervisors should build cordial relationships with their subordinates to grant them the confidence to voice out or discuss with them, their perspectives within the functions of the organization. Furthermore, based on this review, it is recommended that employers should design programs that will include mentoring as part of regular training and development schemes in order to promote future leaders and capable workforce for the future competitive business atmosphere. It is recommended that new recruits should be assigned to more experienced employees to learn the rudiments of the workings of their various organizations. However, limitations of this study should be noted, thus; this research is based wholly on literature review therefore, the extent of generalization is uncertain, nonetheless, further research could be conducted empirically to confirm and reaffirm the validity or otherwise of this study. Despite the above limitations the present study offers support for the conceptual framework developed for comparison for future research. Given the link between mentee benefits and organizational benefits as reflected in the developed hypothesis, it is hoped that the current study has underlined the significance of mentoring in promoting organizational performance. Moreover, it is hoped that the current study will arouse researchers to examine mechanisms which can build on the effectiveness of the relationship existing between mentees, mentors and their organizations.

### References

- Agarwala, T. (2003). Innovative human resource practices and organizational commitment: An empirical investigation. *International Journal of Human Resource Management*, 14(2), 175-197. doi: 10.1080/0958519021000029072
- Alred, G. (2014). *Mentoring pocketbook*. Alresford: Management Pocketbooks.
- Armstrong, T. (2009). *Multiple Intelligences in the Classroom*. Alexandria: ASCD.
- Aryee, S., Budhwar, P. S., & Chen, Z. X. (2002). Trust as a mediator of the relationship between organizational justice and work outcomes: Test of a social exchange model. *Journal of Organizational Behaviour: The International Journal of Industrial, Occupational and Organizational Psychology and Behaviour*, 23(3), 267-285. doi: 10.1002/job.138
- Bailey, N., & Kurland, N. B. (1999). The advantages and challenges of working here, there, anywhere, and anytime. *Organizational dynamics*, 28(2), 53-68. doi: 10.1016/S0090-2616(00)80016-9
- Baskarada, S. (2014). Qualitative case study guidelines. *The Qualitative Report*, 19(40), 1-25. Retrieved from <https://ssrn.com/abstract=2559424>

- Brown, A., Bimrose, J., Barnes, S. A., & Hughes, D. (2012). The role of career adaptabilities for mid-career changers. *Journal of vocational behaviour*, 80(3), 754-761. doi: 10.1016/j.jvb.2012.01.009
- Butler, C., Macfarlane, F., Humphrey, C., Hughes, J., Greenhalgh, T., & Pawson, R. (2011). A new workforce in the making. *Journal of health organization and management*, 25(1), 55-72. doi: 10.1108/14777261111116824
- Chao, G. T. (2007). Mentoring and organizational socialization. In B. R. Ragins & K. E. Kram (Eds.), *The Handbook of Mentoring at Work: Theory, Research, and Practice*, 179-196. New York: SAGE.
- Chao, G. T. (2009). Formal mentoring: Lessons learned from past practice. *Professional Psychology: Research and Practice*, 40(3), 314-320. doi: 10.1037/a0012658
- Christensen Hughes, J., & Rog, E. (2008). Talent management: A strategy for improving employee recruitment, retention and engagement within hospitality organizations. *International Journal of Contemporary Hospitality Management*, 20(7), 743-757. doi: 10.1108/09596110810899086
- Clutterbuck, D. (2014). *Everyone needs a mentor*. London: Kogan Page Publishers.
- Creswell, J. W., & Poth, C. N. (2017). *Qualitative inquiry and research design: Choosing among five approaches*. New York: SAGE.
- Crisp, G., & Cruz, I. (2009). Mentoring college students: A critical review of the literature between 1990 and 2007. *Research in higher education*, 50(6), 525-545. doi: 10.1007/s11162-009-9130-2
- Davis, T., Cutt, M., Flynn, N., & Mowl, P. (2016). *Talent assessment: A new strategy for talent management*. Abingdon: Routledge.
- Dobrow, S., & Higgins, M. (2005). Developmental networks and professional identity: A longitudinal study. *Career development international*, 10(6/7), 567-583. doi: 10.1108/13620430510620629
- Ehrich, L. C., Hansford, B., & Tennent, L. (2004). Formal mentoring programs in education and other professions: A review of the literature. *Educational administration quarterly*, 40(4), 518-540. doi: 10.1177/0013161X04267118
- Elnaga, A., & Imran, A. (2013). The effect of training on employee performance. *European Journal of Business and Management*, 5(4), 137-147. Retrieved from [http://www.academia.edu/download/50840073/137-147\\_Vol\\_5\\_No\\_4\\_2013.pdf](http://www.academia.edu/download/50840073/137-147_Vol_5_No_4_2013.pdf)
- Eraut, M., & Hirsh, W. (2010). The significance of workplace learning for individuals, groups and organisations. *Skope*, 6, 1-97. Retrieved from <http://sro.sussex.ac.uk/id/eprint/23248/>
- Fernandez-Alles, M., & Ramos-Rodríguez, A. (2009). Intellectual structure of human resources management research: A bibliometric analysis of the journal Human Resource Management, 1985-2005. *Journal of the American Society for Information Science and Technology*, 60(1), 161-175. doi: 10.1002/asi.20947
- Freedman, S. (2009). Effective mentoring. *IFLA Journal*, 35(2), 171-182. doi: 10.1177/0340035209105672
- Garvey, R., Strokes, P., & Megginson, D. (2010). Coaching and mentoring: Theory and practice. *NHRD Network Journal*, 3(2), 79. doi: 10.1177/0974173920100214

- Hall, D. T. (2004). Self-awareness, identity, and leader development. In D. V. Day, S. J. Zaccaro & S. M. Halpin (Eds.), *Leader Development for Transforming Organizations: Growing Leaders for Tomorrow*, 173-196. Abingdon: Routledge.
- Hareli, S., & Rafaeli, A. (2008). Emotion cycles: On the social influence of emotion in organizations. *Research in organizational behaviour*, 28, 35-59. doi: 10.1016/j.riob.2008.04.007
- Hattingh, M., Coetzee, M., & Schreuder, D. (2005). Implementing and sustaining mentoring programmes: A review of the application of best practices in the South African organisational context. *SA Journal of Human Resource Management*, 3(3), 40-48. doi: 10.4102/sajhrm.v3i3.73
- Herzberg, F. (2008). *One more time: How do you motivate employees?* Harvard: Harvard Business School Publishing.
- Huselid, M. A., & Becker, B. E. (2011). Bridging Micro and Macro Domains: Workforce Differentiation and Strategic Human Resource Management. *Journal of Management*, 37(2), 421-428. doi: 10.1177/0149206310373400
- Jackson, P. (2008). Coaching, Mentoring and Organizational Consultancy: Supervision and Development. *Coaching: An International Journal of Theory, Research and Practice*, 1(1), 102-105. doi: 10.1080/17521880701878190
- Kahle-Piasecki, L. (2011). Making a mentoring relationship work: What is required for organizational success. *Journal of Applied Business and Economics*, 12(1), 46-56. Retrieved from <http://t.www.na-businesspress.com/JABE/PiaseckiWeb.pdf>
- Klasen, N., & Clutterbuck, D. (2012). *Implementing mentoring schemes*. Abingdon: Routledge.
- Knight, G. A., & Cavusgil, S. T. (2004). Innovation, organizational capabilities, and the born-global firm. *Journal of international business studies*, 35(2), 124-141. doi: 10.1057/palgrave.jibs.8400096
- Kopp, E. M., & Hinkle, J. L. (2006). Understanding mentoring relationships. *Journal of Neuroscience Nursing*, 38(2), 126-131. doi: 10.1097/01376517-200604000-00009
- Lee, C. H., & Bruvold, N. T. (2003). Creating value for employees: investment in employee development. *The International Journal of Human Resource Management*, 14(6), 981-1000. doi: 10.1080/0958519032000106173
- Manzoor, Q. A. (2012). Impact of employees' motivation on organizational effectiveness. *Business management and strategy*, 3(3), 36-44. Retrieved from <http://www.academia.edu/download/37474091/265-706-1-PB.pdf>
- Mathews, P. (2003). Academic mentoring: Enhancing the use of scarce resources. *Educational management & administration*, 31(3), 313-334. doi: 10.1177/0263211X03031003007
- Neupane, R. (2015). Effects of coaching and mentoring on employee performance in the UK hotel industry. *International Journal of Social Sciences and Management*, 2(2), 123-138. doi: 10.3126/ijssm.v2i2.12323
- Osabiya, B. J. (2015). The effect of employees' motivation on organizational performance. *Journal of public administration and policy research*, 7(4), 62-75. doi: 10.5897/JPAPR2014.0300
- Ozolina-Ozola, I. (2014). The impact of human resource management practices on employee turnover. *Procedia-Social and Behavioural Sciences*, 156, 223-226. doi: 10.1016/j.sbspro.2014.11.178

- Parsloe, E., & Leedham, M. (2009). *Coaching and Mentoring: Practical Conversations to Improve Learning*. London: Kogan Page Publishers.
- Rekar-Munro, C. (2009). Mentoring needs and expectations of generation-y human resources practitioners: Preparing the next wave of strategic business partners. *Journal of Management Research*, 1(2), E1. doi: 10.5296/jmr.v1i2.94
- Sandhya, K., & Kumar, D. P. (2011). Employee retention by motivation. *Indian Journal of science and technology*, 4(12), 1778-1782. Retrieved from [https://www.academicpublishingplatforms.com/downloads/pdfs/ijst/volume1/201201031106\\_IJST\\_Vol4\\_Dec\\_2011\\_10.pdf](https://www.academicpublishingplatforms.com/downloads/pdfs/ijst/volume1/201201031106_IJST_Vol4_Dec_2011_10.pdf)
- Scardamalia, M., & Bereiter, C. (2006). An Architecture of Collaborative: Knowledge building. In E. De Corte, M. C. Linn, H. Mandl & L. Verschaffel (Eds.), *Computer-Based Learning Environments and Problem Solving*. Berlin: Springer.
- St-Jean, E., & Audet, J. (2012). The role of mentoring in the learning development of the novice entrepreneur. *International Entrepreneurship and Management Journal*, 8(1), 119-140. doi: 10.1007/s11365-009-0130-7
- Stone, F. (2007). *Coaching, counselling and mentoring: How to choose and use the right technique to boost employee performance*. Concordville: Soundview Executive Book Summaries.
- Terrion, J. L., & Leonard, D. (2007). A taxonomy of the characteristics of student peer mentors in higher education: Findings from a literature review. *Mentoring & Tutoring*, 15(2), 149-164. doi: 10.1080/13611260601086311
- Ulrich, D. (1996). *Human resource champions: The next agenda for adding value and delivering results*. Harvard: Harvard Business School Publishing.
- Yee, R. W., Yeung, A. C., & Cheng, T. E. (2010). An empirical study of employee loyalty, service quality and firm performance in the service industry. *International Journal of Production Economics*, 124(1), 109-120. doi: 10.1016/j.ijpe.2009.10.015

## Contact information

### **Victor Kwarteng Owusu**

Tomas Bata University in Zlín, Faculty of Management and Economics  
 Mostní 5139, 76001, Zlín, Czech Republic  
 E-mail: owusu@utb.cz  
 ORCID: 0000-0003-0520-3643

### **doc. PhDr. Ing. Aleš Gregar, CSc.**

Tomas Bata University in Zlín, Faculty of Management and Economics  
 Mostní 5139, 76001, Zlín, Czech Republic  
 E-mail: gregar@utb.cz  
 ORCID: 0000-0001-9939-5222

doi: 10.7441/dokbat.2019.083

# POST-CRISIS EXPANSIONARY FISCAL CONTRACTIONS

*Jakub Pavelek*

## **Abstract**

Aim of this paper is to verify empirically the theory of expansionary fiscal contractions. Basis of this theory is that fiscal consolidation can have non-Keynesian effects, i.e. budget constraints will not lead to drop in private consumption and investment, and on the contrary, it will lead to rise of this economic index. This theory can be examined by several approaches. In this study, it will be done by using econometric methods, namely panel regression, using fixed effects ordinary least squares. As title suggests, this analysis is focused on years following the financial and economic crisis in years 2008 and 2009 respectively. Some countries used this approach in post-crisis years to stimulate consumption, investment and economic growth. Study examines 28 countries of European Union between years 2009-2018. Results show, that both, private consumption and investment react more to economic development, than to administrative changes, made by governments to influence economic agents' behaviour. Households and firms react very little or not at all to these impulses. If government still makes this effort to change behaviour, they should focus on changing taxes in spite of other fiscal policy instruments, such as transfer payments. Furthermore, it was not concluded, that households and firms follow this non-Keynesian effect. Periods with fiscal contractions did not have unexpected results by standard Keynesian theory.

*Keywords:* *fiscal policy, expansionary fiscal contractions, panel models, post-crisis*

## **1 INTRODUCTION**

The economic crisis in the years 2008 – 2009 was not only big challenge for most governments and institutions in the world, but it was also a big opportunity. For governments, firms, but also for economists and researchers. Lot of valid theories to that date suddenly seemingly stopped working and the world needed some new ones. Some economists, researchers and even governments rediscovered the theory of expansionary fiscal consolidations, which seemed like a win-win strategy for that time. With increasing debt and decreasing economic activity, some tried to reduce government spending with aim to support economy.

There are two approaches to studying these effects. First, recently widely used is econometric approach. This approach is more favored in recent years, when is much emphasized mathematic side of economics. Studies are made by using quantitative methods and raw, hard data. The other approach is called “narrative.” It focuses more on identifying fiscal consolidation episodes in a country by studying government materials. In this paper, the former will be used.

Paper is structured (apart from introduction and conclusion) to two chapters. In former, theory of expansionary contractions will be introduced and several of earlier results shown. In latter, own analysis is performed. The goal is to define, if some periods with fiscal contractions, which leads to increase in private consumption and investment exist.

## **2 EXPANSIONARY FISCAL CONTRACTIONS**

Active fiscal policy is made with aim to affect macroeconomic indicators. Traditional Keynesian theory believes that fiscal contractions (mainly reduced government spending and/or

increase of taxation) lead to contraction of a whole economy. Aim of this paper is to show that fiscal consolidations can lead to expansion in private spending, both consumption and investment as stated by Barry and Devereux (1995) and therefore correlation between private spending and fiscal contraction is negative. This can be done if some conditions are met. Firstly, anticipation of economic agents is key for this model. Significant reduction of government expenditure may lead to anticipation of tax reduction in near future. This may lead to increase in private consumption and investment.

Another effect can be with tax increase in case of high government indebtedness. If the fiscal policy will appear to public as an attempt to reduce government debt, it can lead to increase of private consumption (Sutherland, 1997). In addition, reducing government spending and borrowing (also debt reducing) will lead to lowering of interest rates which will have positive effect on private spending. Perotti (1999) leads with hypothesis that these effects have higher probability to occur if there is a big public debt-to-GDP ratio. Such policies can also influence labour market, if it is done on expenditure side of government balance, mainly salaries (Ardagna 2004).

Alesina and Perotti (1997) make distinction between two types of fiscal adjustments. First occurs when expenditure is reduced by cuts in social expenditures and public sector wages. Second then occurs when deficit is reduced by increase in taxation.

## 2.1 Overview of empirical literature

Jeong (2018) examined these effects in 18 OECD countries by using econometric approach, namely dynamic GMM panel data regression. Conclusions of the paper are that fiscal consolidations are unlikely to be expansionary for GDP growth. Contrarywise, the study suggest that fiscal consolidation has negative effect on economic growth. Results do not support the expansionary fiscal consolidation hypothesis. In particular, the analyses find that fiscal consolidations during high debt-to-GDP ratios, based on spending cuts, or with high sovereign default risk exert fewer negative effects on economic growth than those during low debt-to-GDP ratios.

According to Guajardo, Leigh and Pescatori (2011), IMF also examined fiscal consolidation in OECD countries. They chose the combination of narrative and econometric approach for their study. They examine the historical record, including Budget Speeches and IMF documents, to identify changes in fiscal policy motivated by a desire to reduce the budget deficit and not by responding to prospective economic conditions. After that, by using that dataset, estimation is made. Their results are that fiscal consolidation has contractionary effects on private domestic demand and GDP. On the other hand, estimates based on conventional measures of the fiscal policy support the expansionary fiscal contractions hypothesis but appear to be biased toward overstating expansionary effects.

Fiscal contraction theory can be examined not only for number of countries, but also for one country alone, as done by Bergman and Hutchinson (2010). Their focus was on country of Denmark. By analysis of data from year 1983, when Denmark did undergo a fiscal reform, they compile a VAR model with impulse responses. Result is that “marginal changes” in fiscal policy (expenditure and tax changes) have the expected effects on output and consumption, i.e. lowering it. However, there is no evidence that the fiscal consolidation in Denmark slowed the economy after controlling for a host of exogenous shocks and business cycle effects.

Nevertheless, studies are not only recent; Giavazzi and Pagano (1990) studied this effect almost 30 years ago. Authors aimed to find out if European fiscal consolidation in 1980s had Keynesian or non-Keynesian effect. Their study was aimed at two countries – Denmark and Ireland. Contrarywise, to previous study, result of this one was that in Denmark, cuts in government



spending were associated with increase in consumption, even in the presence of increase in taxes. In Ireland, it was the other way around. Authors emphasize importance of liquidity for operation of this mechanism. When it is not present, it can lead to 7% drop in real consumption in the years of stabilization, as shown in Ireland. (Giavazzi & Pagano, 1990)

Same authors did not stop there and few years later made analysis for international evidence as well as for one country. First, authors used cross-country data for 19 OECD countries. In second part, they analysed Swedish fiscal adjustment in the early 1990s. Cross-country evidence then confirmed that fiscal policy changes could have non-Keynesian effects. However, according to authors, if they should have these effects, they need to be large and persistent. In Sweden, authors observed that decrease in taxation was followed by fall in private demand. (Giavazzi & Pagano, 1996)

Ardagna (2004) implies, that determinants, if fiscal consolidation will be successful or not are mainly dynamics of the debt-to-GDP ratio and GDP growth. Once more, this author uses panel data from OECD countries to make his analysis. Results are that success of fiscal adjustments depends on their size, rather than its composition. This is true more, the lower is the debt-to-GDP ratio. In addition, rate of output growth matters, but higher GDP growth does not drive the success of a fiscal stabilization. Whether a fiscal adjustment is expansionary depends largely on the composition of the fiscal impulse. In particular, stabilizations implemented by cutting public spending lead to higher output growth rates. This is done mostly through labour channel, rather than the agents' expectations. Ardagna (2004) also examined how monetary policy influences those output that are changed with fiscal contractions. Results show that successful and expansionary fiscal contractions are not the result of accompanying expansionary monetary policy.

The empirical evidence shows that the existence of non-Keynesian effects may well depend upon the size and the persistence of the fiscal adjustment. However, the available empirical work so far does not seem to reject completely the expansionary fiscal contraction hypothesis. The composition of the adjustment is also relevant, that is, to what degree the fiscal contraction is based on tax increases and public investment or government consumption cuts.

Another point is the fact that this theory seems to depend on size of public debt. When the level of public debt or of the budget deficit is small, it will most likely see traditional Keynesian effect. On the contrary, if a country has an important budget deficit or a very high debt-to-GDP ratio, a fiscal consolidation may produce the non-Keynesian effects discussed above.

### **3 DATA AND MODEL SPECIFICATION**

Linear regression econometric model will be used for quantitative analysis in the paper. Since this study aims on identifying expansions after crisis, years 2009 – 2018 were chosen for analysis. Countries used are all 28 members of European Union (even though Croatia was not part of European Union until 2013, it is still included, since it must have undergone some fiscal adjusting nevertheless). With all that, this model therefore will be panel regression and OLS method with fixed effects will be used to estimation. All necessary data were obtained from Eurostat database. Then edited so they would fit ordinary least squares regression requirements. For estimation is used software Eviews.

### 3.1 Descriptive statistics

Tab. 1 – Descriptive statistics of data. Source: own research

Series	Mean	Std. dev	Min	Max	N
<i>C</i>	12,511	5,836	3,206	25,233	280
$\Delta C$	0,110	0,274	-1,376	0,737	252
<i>I</i>	5,349	3,584	1,116	20,060	280
$\Delta I$	0,140	0,732	-4,775	6,404	252
<i>Y</i>	25,141	16,132	5,053	84,410	280
$\Delta Y$	0,399	0,865	-2,272	9,644	252
<i>G</i>	5,178	3,384	0,827	14,036	280
$\Delta G$	0,016	0,095	-0,370	0,300	252
<i>TR</i>	0,294	0,227	0,002	1,018	280
$\Delta TR$	0,001	0,047	-0,234	0,194	252

Data in this table are displayed as 1000EUR per capita for given variable.

As we can see, biggest change is in GDP per capita, closely followed with investment of private companies. Most rigid variables are government spending and especially transfer payments. Private consumption lies somewhere between. Statistics shown is mostly expected as economic development can be have relatively big deviations and can change rather quickly for which reacts mostly private investment and of course households spending. For government spending and transfer payments, those are given administratively, so their rigidity is expected, as governments reacts slowly and changes are rather small, as we can see in standard deviations of those two variables. It also depends, how the government budget is constructed, on degree of fiscal decentralization and portion of mandatory expenses in given budget.

### 3.2 Specification of the models

Aim of the analysis is to conclude if reduced government spending and/or increase in taxation will lead to increase in consumer behaviour. There will be two separate models, each examining one part of private spending. For the first one, private consumption will be examined and in the second one, it will be private investment. Therefore, models will be specified as:

$$\Delta C_{it} = \beta_0 + \beta_1 Y_{it-1} + \beta_2 \Delta Y_{it} + \beta_3 \Delta G_{it} + \beta_4 \Delta TR_{it} + \beta_5 \Delta t_{it} + \beta_6 FC_{it} + \mu_{it} \quad (1)$$

where the index *i* (*i* = 1,...,N) denotes the country and index *t* (*t* = 1,...,T) indicates the period. Variables used in model are: *C* – private consumption, *Y* – gross domestic product, *G* – general government final consumption expenditure, *TR* – social transfer payments, *t* – taxes. *FC* is dummy variable which is used to control if there was a fiscal contraction made that year, with value 1 meaning fiscal contraction in given year occurred and value 0 meaning that it did not occurred in that year.

Second model, which emphasizes private investment, will be specified as such:

$$\Delta I_{it} = \beta_0 + \beta_1 Y_{it-1} + \beta_2 \Delta Y_{it} + \beta_3 \Delta G_{it} + \beta_4 \Delta TR_{it} + \beta_5 \Delta t_{it} + \beta_6 FC_{it} + \mu_{it} \quad (2)$$

where everything is the same with exception of *I*, which in this case is of course private investment. All data are nominal value for the given year per capita. With exception of taxes, which are used as a percentage. Including of variables is mainly self-explanatory. We want to know how private sector reacts to changes in government spending, taxation, and of course, development of the economy and to its recent status. Dummy variable is there to find out, if public spending reacts differently in time with episodes of fiscal contraction. None of the explanatory variables is correlated with others, even transfer payments and government spending, where it could be expected.

### 3.3 Results of the models

Tab. 2 – Estimation outputs. Source: own research

Variable	Coefficient for $\Delta C_{it}$	Coefficient for $\Delta I_{it}$
$Y_{it-1}$	-0,002 (-0,196)	-0,103*** (-3,910)
$\Delta Y_{it}$	0,144*** (7,900)	0,391*** (6,232)
$\Delta G_{it}$	1,054*** (4,810)	0,174 (0,230)
$\Delta TR_{it}$	-0,303 (-1,126)	-0,720 (-0,775)
$\Delta t_{it}$	-0,130** (-2,140)	-0,420** (-2,018)
$FC_{it}$	-0,003 (-0,924)	-0,003 (-0,218)

The numbers are coefficients for given variables, stars are used for explaining significance with \*\*\* and \*\* meaning significant on one percent, and 5 percent respectively. Number in parenthesis is t—statistics.

As results show, consumption of households reacts mostly to development of economic situation in given country and to change in government spending. It needs to be said, that relationship between GDP development and consumption development works both ways. If GDP rises, households are prone to more spending, but of course as spending is part of GDP calculation, rise in spending leads to rise in GDP. However, interestingly, household consumption does not react to change in transfer payments. Some explanations could be that even if economic agents are vary of government actions, they do not know exactly what they mean. Other explanation is the fact that change in government spending rarely means big change in transfer payments (which was concluded from the fact, that these two variables are not correlated). Households also reacts on changes in taxes, as expected. There can be seen a negative relation between those two variables. When taxes rise, spending decrease and vice versa. As for dummy variable and episodes of fiscal contraction, the model did not find any evidence of household changing their behaviour in times of consolidation. For private investment, results are as expected. Firms reacts mostly to economic situation in the given country, as statistical significance is highest in GDP variables. Model estimated that firms are also interested in size and changes of taxes. As for government spending, it concluded, that firms are mostly not interested in that and with it to the times of fiscal consolidation.

## 4 CONCLUSION

Popularity of expansionary fiscal contractions theory rose in recent years, mainly as a reaction to economic crisis. When some of mainstream economic theories seemed to lose their effect, some researched tried to come with something new and fresh. Some of them tried to rework older, not used theories and tried to find out, if they can be used in these times.

This paper tried to verify empirically one of these theories. Results are that in examined time and countries, this effect was not present. Mainly because studied variables are not very influenced by change in government expenditure and react more on other realities. This is author's first insight to this topic and by no means is research in this area done. There are numerous factors, which can be included, for future research and ways, where it can lead. First, it could be useful to make compilation of narrative and quantitative approach, e.g. first properly identify times of budget consolidations.

## References

- Alesina, A., & Perotti, R. (1997). Fiscal Adjustments in OECD countries: Composition and Macroeconomic Effects. *International Monetary Fund Staff Papers*, 44(2), 210-248. doi: 10.2307/3867543
- Ardagna, S. (2004). Fiscal Stabilizations: When do they Work and Why. *European Economic Review*, 48(5), 1047-1074. doi: 10.1016/j.euroecorev.2003.09.010
- Barry, F., & Devereux, M. B. (1995). The Expansionary Fiscal Contraction Hypothesis: A Neo-Keynesian Analysis. *Oxford Economic Papers*, 47(2), 249-264. doi: 10.1093/oxfordjournals.oep.a042169
- Bergman, U. M., & Hutchinson, M. M. (2010). Expansionary Fiscal Contractions: Re-evaluating the Danish Case. *International Economic Journal*, 24(1), 71-93. doi: 10.1080/10168731003589857
- Giavazzi, F., & Pagano, M. (1990). Can Severe Fiscal Contractions be Expansionary? Tales of Two Small European Countries. *NBER Macroeconomics Annual*, 5, 75-111. doi: 10.1086/654131
- Giavazzi, F., & Pagano, M. (1996). Non-Keynesian Effects of Fiscal Policy Changes: International Evidence and the Swedish Experience. *Swedish Economic Policy Review*, 3(1), 67-103. doi: 10.3386/w5332
- Guajardo, J., Leigh, D., & Pescatori, A. (2011). Expansionary Austerity: New International Evidence. *International Monetary Fund Working Paper*, 11/158, 1-40. Retrieved from <https://ssrn.com/abstract=1886910>
- Jeong, J. K. (2017). Effects of Fiscal Consolidation in 18 OECD Countries. *Seoul Journal of Economics*, 30(1), 51-91. Retrieved from <https://ssrn.com/abstract=2925036>
- Perotti, R. (1999). Fiscal Policy in Good Times and Bad. *The Quarterly Journal of Economics*, 114(4), 1399-1436. doi: 10.1162/003355399556304
- Sutherland, A. (1997). Fiscal Crises and Aggregate Demand: Can High Public Debt Reverse the Effects of Fiscal Policy? *Journal of Public Economics*, 65(2), 147-162. doi: 10.1016/S0047-2727(97)00027-3

## Contact information

### Ing. Jakub Pavelek

VSB – Technical University of Ostrava, Faculty of Economics  
Sokolská třída 33, 70200, Ostrava, Czech Republic  
E-mail: [jakub.pavelek@vsb.cz](mailto:jakub.pavelek@vsb.cz)  
ORCID: 0000-0001-9920-9952

doi: 10.7441/dokbat.2019.084

# THE RISK MANAGEMENT IN THE SELECTED COMPANY

*Radim Pavelek*

## **Abstract**

The paper deals with risk management in the organization SFINX in the Czech Republic. Firstly, there is a literature review of risk management. Secondly, there is a used methodology part. In this part is discussed SWOT analysis and risk matrix with a modified score method. In the questionnaire, the risks were divided into A) Production risks (technical, social, purchasing, distribution), B) Economic risks, C) Market risks, D) Financial risks, E) Political risks. The probability of the occurrence of the risk was assessed: value one for the lowest occurrence, while value five for the highest, the most probable occurrence. The impact was assessed similar: number one for the least serious impact, while number five for the most severe effect. Based on the questionnaire were evaluated the most critical risks that threaten the organization from the perspective of employees. The resulting risk is determined by the product of the probability and impact of the risk. In this paper, risk was determined by multiplying the average values of probability and impact of the selected risk. The averages of these two quantities were obtained based on a questionnaire survey. Then the selected risks were entered on the map, for the risks placed in the significant risk values quadrant and the critical risk values quadrant, the scoring method recommends making proposals to reduce them. In this work, the technique will be adjusted so that the probability and impact will be evaluated from 1 to 5. In the end of the paper, there are presented the results based on the mentioned methodology – the most severe risks that may threaten the organization. Finally, there is recommendations for the organization.

*Keywords: risk, questionnaire, SWOT analysis, risk matrix, score method*

## **1 INTRODUCTION**

Risk intrinsically belongs to our world. Furthermore, risks affect the life of the company; therefore, risk management is needed. Risk management enables an organization to identify, analyse, and evaluate hazards that could seriously endanger the company. After their evaluation, the company could propose measures that reduce the risk. However, not all actions operate in practice; therefore, after the measure has been implemented, it is necessary to check whether it works, if not, to come up with a unique solution. Gratitude to risk management, the organization, could prepare in the future for what could threaten it (economic crisis or poorly chosen strategy and related problems etc.). If an enterprise knows what it could endanger, it could respond more flexibly to future challenges and avoid any financial loss, loss of market position, or even its disappearance.

This paper deals with risk management in the selected organization, the SFINX factory in Holešov, which falls under Nestlé Česko, s.r.o. In the methodological part are introduced methods that will be used. With the advice of a questionnaire, a modified scoring method, and a risk matrix, we will present the most serious risks that may endanger a given company. For the most severe threats, possible proposals to reduce them will be presented. (Walter, 2013)

## 2 METHODOLOGY

The aim of this paper is to assess the risks that may threaten the organization. The following methods are used - questionnaire, SWOT analysis and Risk matrix with the modified scoring method.

### 2.1 Questionnaire

The questionnaire survey is one of the most popular methods of research; it is a mass gathering of data from interviewed persons. In the questionnaire, the risks were divided into A) Production risks (technical, social, purchasing, distribution), B) Economic risks, C) Market risks, D) Financial risks, E) Political risks. The probability of the occurrence of the risk was real: value one was the lowest occurrence, while value five was the highest, the most probable occurrence. The impact was real: number one was for the least serious impact, while number five was for the most severe effect. Based on the questionnaire were evaluated the most critical risks that threaten the organization from the perspective of employees. (Litschmannová, 2009)

Tab. 1 – The probability of occurrence. Source: Litschmannová (2009)

Classification	Verbal expression
1	Practically unlikely
2	Not very likely
3	Occasionally
4	Likely to frequent
5	Very frequent

Tab. 2 – Impact on risk. Source: Litschmannová (2009)

Classification	Verbal expression
1	Negligible
2	Low
3	Medium
4	Serious
5	Critical

### 2.2 SWOT analysis

SWOT analysis is a universal tool that maps and analyses a given phenomenon (e.g., a particular state or project, etc.). The analysed subject is examined from Strengths, Weakness, Opportunities and Threats points of view (Badal, 2019).

### 2.3 Risk matrix with modified Score method

The scoring method includes the risk identification phase, the risk assessment, and the design of the risk reduction measures. The technique makes it possible to evaluate risks that are not precisely numerically expressed. This method deals with lists of hazards from the four most crucial areas – technical, financial, personnel and business risks. (Lacko, n.d.)

Tab. 3 – Risk Matrix. Source: Lacko (n.d.)

		Impact (D)				
		1	2	3	4	5
Probability (P)	5	5	10	15	20	25
	4	4	8	12	16	20
	3	3	6	9	12	15
	2	2	4	6	8	10
	1	1	2	3	4	5

Table 3 shows the risk matrix - it is a 5 x 5 matrix, the probability and impact of risks is evaluated from 1 to 5, the higher the number, the higher the likelihood and impact of the risk.

The resulting risk is determined by the product of the probability and impact of the risk. In this paper, risk will be determined by multiplying the average values of probability and impact. The averages of these two quantities will be obtained based on a questionnaire survey.

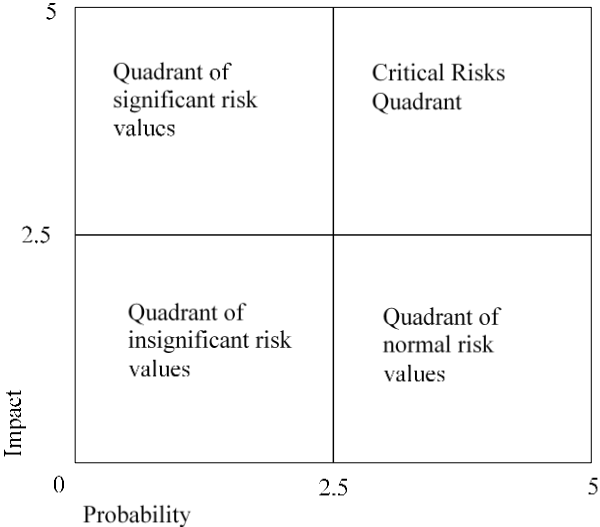

Fig. 1 – Risk map. Source: Lacko (n.d.)

A risk map is used to represent risks graphically. On the horizontal axis, there is the possibility of occurrence (probability) of risk; the vertical axis represents the impact assessment. Based on these two values, the risk is entered on the map. The entire plan is divided into four quadrants: the insignificant risk values quadrant, the normal risk values quadrant, the significant risk values quadrant, and the critical risk values quadrant. For the risks placed in the last two quadrants, the method recommends making proposals to reduce them. In this work, the technique will be adjusted so that the probability and impact will be evaluated from 1 to 5.

### 3 RESULTS

#### 3.1 Questionnaire

Based on the questionnaire was evaluated the most severe risks that threaten the organization from the perspective of employees. The survey dealt with the risks as they were divided above A) Production risks (technical, social, purchasing, distribution), B) Economic risks, C) Market risks, D) Financial risks, E) Political risks. Fifty-four respondents participated in the questionnaire survey.

In terms of position, the most frequent respondents in the questionnaire were operators, followed by technical-economic workers and production masters. The least numerous respondents were management staff. In terms of the length of employment, the most frequent respondents were workers with a period of work between three and five years. However, the proportion of respondents from individual groups was very balanced.

When comparing the most severe risks from individual groups, most respondents stated that the most critical risks were supply risk (R = 16 approximately, from the category of purchasing risks of production) assessed as probable to frequent (4) with serious (4) from economic risks (R = 16 approximately).

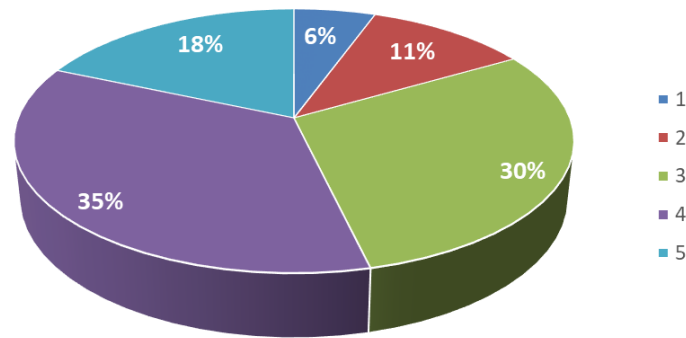

Fig. 2 – Probability of supply risks. Source: own research

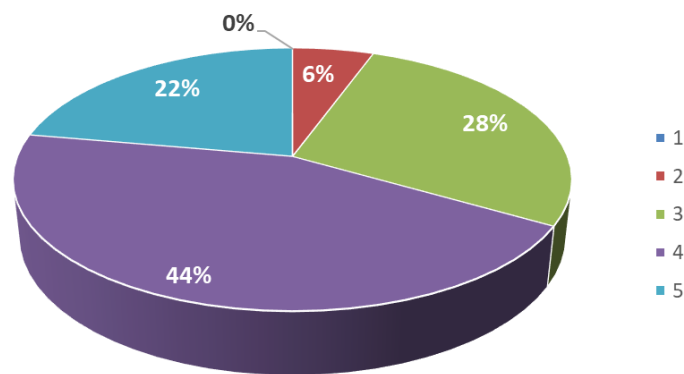

Fig. 3 – Evaluation of the impact of supply risks by respondent. Source: own research

### 3.2 SWOT analysis

In the SWOT analysis are first described internal factors that influence the organization - strengths, and weaknesses. The following are external factors that are related to the environment - opportunities and threats.

Tab. 4 – SWOT analysis. Source: own research

Strengths	Weakness
Wide range of quality products	High staff turnover
Traditional marks	Increasing price of products
ISO certificate	Increasing operating costs
Important employer in the region	Obsolete machinery
Opportunities	Threats
New markets abroad	New competition
Cooperation with new suppliers	Loss of customers
Healthy lifestyle trend	Cost increases linked to stricter EU standards
Increasing standard of living of the inhabitants	Economic crisis
Increasing emphasis on business ethics	Increasing price of raw materials needed for production

### 3.3 Risk Matrix with modified Score method

For the scoring method, we first compiled a table of risk factors, assigning a sequence number to each element. For the valuation of risks, we set values from 1 to 5 for both the possibility of risk occurrence and its impact (as in the questionnaire survey).

The resulting risk ranged between 1 and 25. The calculation can be imagined in the following risk matrix with a modified scoring method. From the individual probabilities evaluated from the questionnaire, we made their average; for the impacts being assessed, we did the same. We multiplied the standards together and got the average overall risk. We divided the overall risk



into three groups: acceptable (low, green in the matrix), conditionally acceptable (medium, yellow in the matrix) and unacceptable (high, red in the matrix).

Tab. 5 – Risk matrix. Source: own research

		Impact (D)				
		1	2	3	4	5
Probability (P)	5	5	10	15	20	25
	4	4	8	12	16	20
	3	3	6	9	12	15
	2	2	4	6	8	10
	1	1	2	3	4	5

The most serious risk factors were: technical, supply, subcontractors, cost risks, and competitive pricing policy. These risks are displayed in the Risk Map in the Critical Risk Value quadrant. See figure below.

Tab. 6 – Valuation of supply risk factor. Source: own research

Risk quantification by company employees	Score (average) supply factor
(P) Possibility of occurrence	3,5
(D) Impact	3,83
<b>Risk assessment = P × D</b>	<b>13,41 ≈ 13</b>

According to the risk matrix, these several serious risks are broken down as follows: (a) supply risks - between conditionally acceptable and unacceptable risks, closer to unacceptable risks; (b) technical risks (as part of production risks), cost, price policy of competition on the border of conditionally acceptable risks; (c) subcontracting risks - in conditionally acceptable risks.

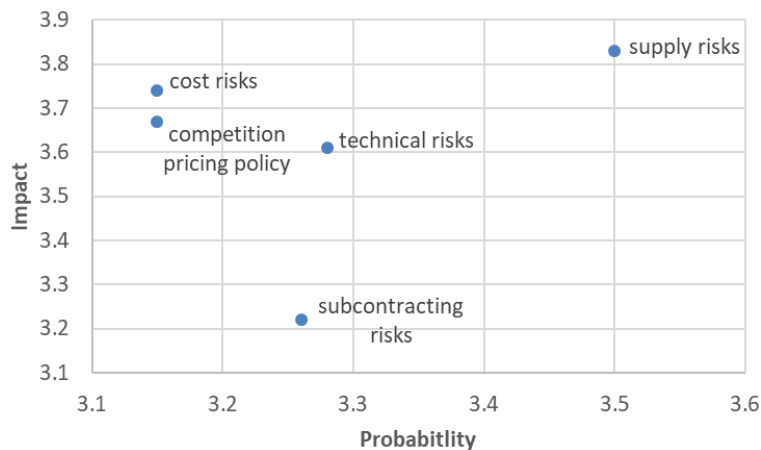

Fig. 4 – Risks in the quadrant of critical risk values in the risk map. Source: own research

#### 4 DISCUSSION AND CONCLUSION

This paper deals with risk management in the selected organization. First, a selected organization was introduced - the SFINX plant in Holešov. Then we switched to the methods used in the paper. The first questionnaire survey was used, the aim of which was to find out what risks the company employees evaluate as the most serious. Then we went to the SWOT analysis, where we assessed the internal and external factors that affect the company. Lastly, we used a modified scoring method in which we evaluated the results obtained by a questionnaire survey. It was found that employees consider the supply risks, technical risks, cost risks, competition pricing policy, and subcontracting risks to be the most serious risks for the company. Based on these results, proposals have been proposed to reduce them.

Tab. 7 – Risk reduction proposals. Source: own research

Risk factor	Precaution suggestion	Responsibility
<b>1. technical</b>	1. Gradual innovation of obsolete production lines. 2. Extension of existing insurance against production failure.	1. Head of Technical Department 2. Factory management
<b>6. supply</b>	1. Optimization of insurance stocks according to orders. 2. Ensuring spare parts of machines.	Head of Logistics Department
<b>7. subcontractors</b>	Securing raw materials from multiple sources - diversification of inputs.	Head of Logistics Department
<b>11. costs (cost risks)</b>	Quantity discounts.	Factory management
<b>17. competition pricing policy</b>	1. Improving the quality of their products. 2. Building a good reputation.	1. Head of the Quality Management Department 2. Management of company

## References

- Badal, T. (2019). *SWOT analýza*. Retrieved from [http://user.mendelu.cz/xbadal/Studijni%20opory/Hospodarska%20informatika/Stud\\_m at/SWOT%20anal%FDza.pdf](http://user.mendelu.cz/xbadal/Studijni%20opory/Hospodarska%20informatika/Stud_m at/SWOT%20anal%FDza.pdf)
- Lacko, B. (n.d.). *Řízení rizik a příležitostí v projektech*. Retrieved from <http://www.projektmanazer.cz/kurz/soubory/modul-g/g5.pdf>
- Litschmannová, M. (2009). *Máme dotazníky. A co dál?* Retrieved from [https://homel.vsb.cz/~lit40/SKOMAM\\_09.PDF](https://homel.vsb.cz/~lit40/SKOMAM_09.PDF)
- Walter, M. (2013). *SFINX Holešov: 150 let výroby cukrovinek*. Retrieved from [www.nestle.cz/cz/media/tiskove-zpravy/sfinx-holesov-150-let-vyroby-cukrovinek#](http://www.nestle.cz/cz/media/tiskove-zpravy/sfinx-holesov-150-let-vyroby-cukrovinek#)

## Contact information

### Radim Pavelek

Tomas Bata University in Zlín, Faculty of Logistics and Crisis Management  
Studentské nám. 1532, 68601, Uherské Hradiště, Czech Republic  
E-mail: [r\\_pavelek@utb.cz](mailto:r_pavelek@utb.cz)  
ORCID: 0000-0002-4476-1771

doi: 10.7441/dokbat.2019.085

# PENSION DEBT OF THE FUTURE AND ITS DEPENDS ON RETIREMENT AGE: COMPARISON BETWEEN CZECHIA AND DENMARK

*Jan Pokorný, Pavlína Hejduková*

## **Abstract**

The issue of population ageing has begun to emerge in the context of public discussions. This topic is important and has significant impacts on public finance and especially pension systems. Some countries may achieve a 1:1 ratio between workers and pensioners in 2050. Calculation of total pension expenditures can reveal what future liabilities are expected. On the other hand, the calculation of pension revenues can show part of the cover. Both indicators must be approached with an awareness of their influence on economic development as well as on social impacts. The paper looks old-age pension as future entitlements and for calculation is used a method of implicit pension debt (IPD). This application is used in Czechia and Denmark. Reasons for selected are similar public pension expenditures as a percent of GDP, but different designs of pension systems. The main aim is to calculation the IPD for both countries and their comparison. The description is used as the first research method. Next, IPD calculation is used and this followed by the method of synthesis. The main results are that Denmark has a higher IPD than Czechia, but pension revenues are poorly predictable because it depends on economic development. Thus, IPD is sensitivity to variables, and this issue can be a topic for the next research.

*Keywords:* pension system, PAYG, implicit pension debt, retirement age, public finance, pension expenditures

## **1 INTRODUCTION**

At this time, one of the important topics is the changing structure of the population which is related to two factors – population ageing and low fertility rate. In this context, the report of World Population Ageing 2017 (UN DESA, 2017) expects to increase the over 60 age group from 382.5 million in 1980 and 962.3 in 2017 to 2080.5 million in 2050 (more than double compared to the year 2017). But it is not just an increase in the absolute numbers. Population share aged 60 and over will grow up from 12.7% in 2017 to 21.3% in 2050. Based on the projection (UN DESA, 2017), the highest share of aged 60 and over will in Japan (42.4% in 2050), followed by Spain (41.9), Portugal (41.7) and Italy (40.3).

The European Union has slightly different method on this topic because uses age limit 65 years and over. The 2018 Ageing Report (European Commission, 2018) expects 29% aged 65 and over in 2070, it is increased by 10% against share in 2016. More than 29% population aged 65 and over will have 13 member countries, f. e. Portugal (35%), Greece, Cyprus (both 34%). On the other hand, a lower ratio of over 65 age group has Ireland (24%), next Sweden (25%), Belgium, France and the United Kingdom (26%).

This development has two impacts on public finance. Firstly, the share of the economically active population will go down over time because people of productive age will be less than this time (in age category 15-64: decrease from 65% in 2016 to 56% in 2070 in member states of the EU). And secondly, people aged 65 and over (or different age limit for retirement) will need help in some areas of their life. It will mean the rise of public finance in some areas as health care, long term care, and pensions.

The last-mentioned area is the thematic of this paper. Pensions and increasing age are connected to issue. Because up to the present, people spend more time in retirement than ever before (provided, that an increase in retirement age will not happen). Therefore, this agenda (changing of retirement age) is often in arenas (Harris, 2019; Gronholt-Pedersen, 2019; Surmanová, 2019; Židek, 2019). Some states have set up a “sustainability factor” to their pension system. It means that the retirement age can be changed based on demographic reports every five years. This factor has Spain, Denmark, Finland, France, Portugal, etc. (Conde-Ruiz & González, 2015).

The theme of this paper is impacting on public finance from view increasing share people in retirement on population. The implicit public debt of public pension systems is measured and it is the result of this paper.

## **2 LITERATURE REVIEW**

The beginning of the pension system development dates back to the 19th century. It was a political response to social and economic changes (Hinrichs & Lynch, 2010). These changes are related to the evolution of society within the Industrial Revolution. Between the outputs of the Industrial Revolution belong to industrialization, urbanization, to change in the structure of economy and loss of traditional family relationships (intergenerational or family solidarity; Baldwin, 1990; Christiansen & Petersen, 2001). The main reason for the established of the pension system was to protect against poverty (Hinrichs & Lynch, 2010).

The pension system can be classified on the basis of several aspects, which include the method of financing, pension plan, participation and model. In the context of this article is important the first aspect – financing of the pension system. Exist 3 models of financing – Pay-As-You-Go scheme (PAYG), fully funded scheme (FF) and Notional Defined Contribution (NDC).

PAYG scheme (also known as solidarity or distributive plan) distributes current revenue by contributors to pensions for the current pensioner. It means that PAYG uses the intergenerational contracts (and solidarity) between contributors and pensioners. Current revenue can be income from insurance or taxes. This scheme is depending on the demographic structure. The scheme is an important old age dependency ratio (the ratio between people aged 65 and over and the number of employed age 20-64 years). The average old age dependency ratio in the EU is 43.1 in 2016 and projection expects to increase the ratio of 54 in 2030 and 68.5 in 2070. The highest number will be 67.8 in Greece and 66.7 in Italy in 2030. 40 years later the highest number will be 92.5 in Poland and 86.7 in Bulgaria (European Commission, 2018). Thus, low fertility, an increase in life expectancy and a high share of people aged retirement mean a higher dependency ratio and vice versa. In the PAYG scheme, the next problem can be high unemployment and a bad economic situation (Peková, 2011; Nistico, 2013).

A fully funded (FF) scheme (also known as accumulative plans) means created pensions fund. Part of current income is invested in financial assets (accumulation of recourses) for old age. This scheme depends on property rights. The premise of the scheme is pensioner will be live from returns of financial assets and its sale (Nistico, 2013). For this system is an important economic situation and distribution of capital (Bikker, 2017).

The last model of financing is the NDC scheme. It is a combination (hybrid scheme) between PAYG and FF schemes. Everyone has a notional account in the scheme. Deposits and revenues are credited to the account, but real revenues are used for current pension entitlement. This system is used in Sweden since 1994 and partly in Latvian since 2000. NDC scheme ensures fiscal stability because it absorbs the pros of PAYG and FF schemes. NDC scheme is stable against the risk of population and the economic crisis (Dundure & Pukis, 2015).

In an unfunded system (as PAYG scheme) can be calculated implicit pension debt (IPD). IPD represents future government obligations (debt) in the unfunded system. Therefore, IPD means pension benefits in the future. Kane and Palacios (1996) write that "...calculating the value of the IPD is a useful step when a country's authorities are considering the implications of ending a pay-as-you-go scheme". Holzmann, Palacois and Zviniene (2001) warned that some countries (f. e. former socialist states in Central and Eastern Europe) have extremely large IPD and other countries have a problem with accumulating IPD and this growth is probably unsustainable for a long time. Two types of IPD are distinguished – gross and net. Gross IPD just represents the present value of the future pension entitlement. Net IPD refers to the present value of the balance of future pension entitlement and future contributions (Szule, 2013).

Pension systems have some important components – schemes and their arrangement or retirement age. Czechia has a two-pillar system and it is organized as a public system. This system is a mandatory unfunded system based on insurance financing. A contribution is 28% from wages. A benefit has two parts. The first part of the benefit is flat-rate which is 10% of the average wage. And the second part is depending on earnings-related in preretirement age. The average monthly benefit is 12,435 CZK in 2018. The benefit is not taxable income when it is lower than 439,200 CZK per year (CSO, 2019; MFCR, 2019). Between 2013 and 2016, the second pillar exists in the Czech Republic. This non-state system has just 85 thousand participants. One of the reasons why this scheme was not popular is the political process of legal access. The third pillar is organized as a voluntary private fund with a contribution by state. The monthly state contribution is depending on individual contributions. When someone savings 300 CZK (minimum saving entitlement to the state contribution) he or she can gain 90 CZK. The maximum state contribution is 230 CZK, individual saving is 1,000 CZK (MFCR, 2019).

Denmark's pension system is composed of three pillars. The first pillar has two parts – state pension and ATP. The state pension is composed of a basic amount, it is a universal benefit based on taxation financing. Entitlement is dependent on time spent in Denmark. It means that for the full basic amount must person spent 40 years in Denmark (or as an employee on Danish boat, diplomatic employee) between 15 and 65. When someone spent 30 years in Denmark, it means that he or she can get ¾ of benefit. The full basic amount is 74,844 in 2018. This benefit is cut when pensioner has other income higher than 322,500 DKK. Pensioners have a claim on additional benefits, f. e: pension contribution is a component for poverty reduction, next contribution to heat, housing or medical expenses (Greve & Hussain, 2019; Denmark, 2019). The second part of the first pillar is ATP. This system has been established in 1964. ATP is mandatory for an employee which is 16 years old or more and works minimum 9 hours per week. A contribution depends on hours worked per week. In 2017, 91% of the Danish population in age 25-60 paid contribution to ATP. An annual benefit of ATP was 23,600 DKK in 2018 (ATP, 2019).

Tab. 1 – Pension system in Czechia and Denmark. Source: own research

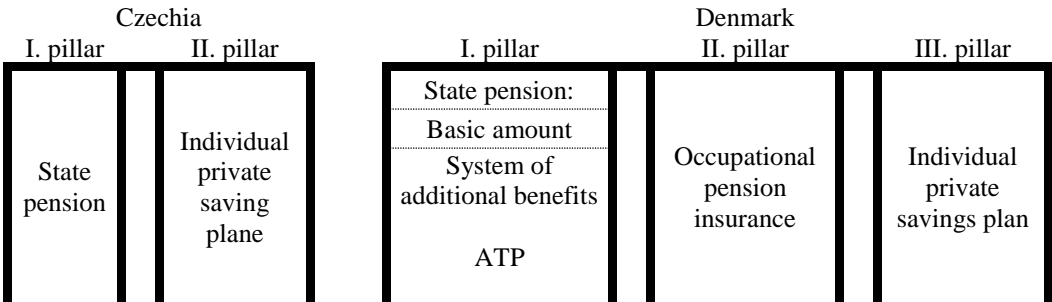

Occupational pension insurance is a mandatory part of the pension system since the 1990s and the importance of this scheme is increasing. The state regulates the minimum insurance rate, but the rate depends on the type of work. The minimum insurance rate is 12% and this rate is used workers in logistic and transport companies, but the higher rate has paramedics and social workers (13-18%), teachers at elementary school (17.3%) and universities (17.1%). Thus, the amount of benefit is slowly increasing as rate and contribution. This part of the pension system is managed by private insurance companies, banks, corporate pension funds. Danish pension funds (including ATP) have accumulated value that is more than 200% GDP. The third pillar is an individual private savings plan and the state does not support this part as Czechia. On the contrary, the rate of taxation is dependent on the subject and capital income is taxed rate between 25 and 42%.

In both countries, actual retirement ages are gradually rising. Firstly, the Czech retirement age rising to 65 years for people birthed in 1972 and later. It changes about 5 years for men and 8-12 years form women (depending on the number of children). And retirement age in Denmark rises about 3 years (from 65 to 68 years). This age is the same for men and women.

### 3 DATA AND METHODS

There are compared two countries from the view of IPD in this paper. These countries were selected regarding their different pension systems, but with similar public pension spending as percentage gross domestic product. This is visible on the Figure 1, where is pension spending as a percentage of GDP for Czechia and Denmark from 2006 to 2015 (for private pension we have data to 2013). Public pension spending for both countries is about 6% in 2006, then rises to 8% at the end of the reference period. A completely different situation is in the area of private pension spending. Private pension spending in Denmark is about 3.7% and rises by more than 2% in 2013. The average private spending on pension in Czechia is 0.4% and with decrease tendency (from 0.6% in 2012 to 0.3% in the next year).

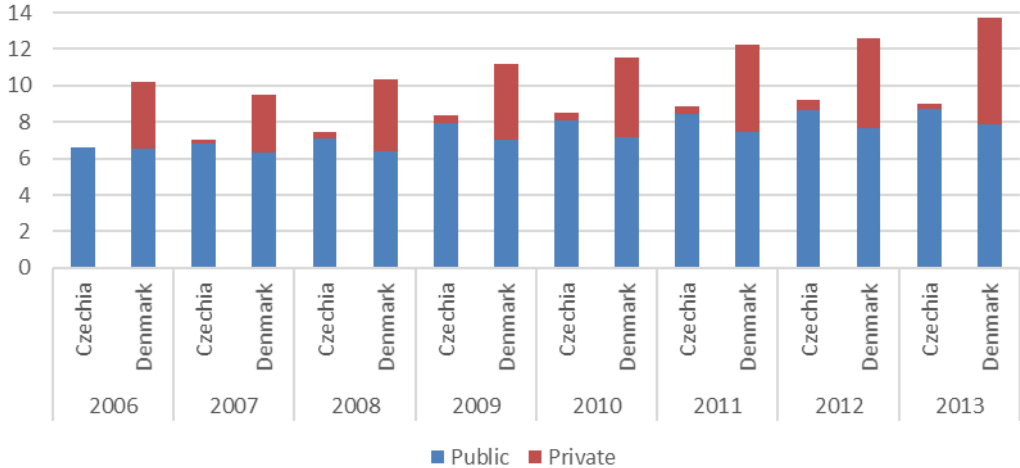

Fig. 1 – Public and private pension spending in Czechia and Denmark. Source: OECD (2019)

A reason for this disparity between these countries is in their design of pension systems, especially in the second pillar. These countries applicate four scenarios with different retirement age and other conditions are the same for all scenarios. Scenarios coming out from retirement age before and after reforms in Czechia and Denmark: (a) Retirement age (RA) is 60 years for men and 55 years for women. This scenario is based rule of Czechia before reform. RA for women when having two children, we use it for every woman based on long-term fertility rate; (b) RA gradually increase to 65 years for men and women too based on a law in Czechia (after

reform); (c) RA is 65 years for men and women in all-time (Denmark before reform); and (d) RA gradually increase to 68 years for men and women based on a law in Denmark (after reform).

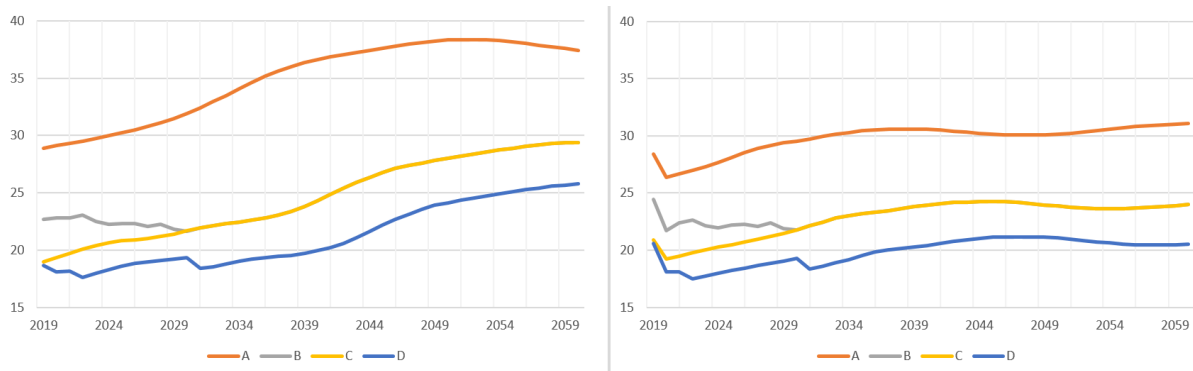

Fig. 2 – Dependency ratio in Czechia (left) and Denmark (right). Source: CSO (2019), StatBank (2019)

Figure 2 is the dependency ratio based on four scenarios (described below) for Czechia before reform of retirement age (A) and after (B) and the same for Denmark (C is before and D after reform). Czech dependency ratio is highly growing between the years 2030 and 2040 in scenario A, other scenarios strongly reduce the ratio change, but their growing phase is in 2040. Danish dependency ratio has gradually risen in 2020-2035 for scenario A and growth in 2030-2040 for other scenarios.

This paper is based on a methodologic procedure by Holzman, Palacios and Zviniene (2001). Firstly, the population is divided into two parts – contributors and pensioners. Then, formulas for revenues and expenditures of pension systems are created based on pension rules in that country. These aspects are depending on the economy and the pension system. A difference between revenues and expenditures is called annual current balance (ACB). From timelines of ACB can calculate net IPD (without revenues it is gross IPD) but have to incorporated time factor – net present value, thus:

$$net\ IPD_j = \sum_{t=1}^n (NPV_{jt} * ACB_{jt}) = \sum_{t=1}^n (NPV_{jt} * TR_{jt}) - \sum_{t=1}^n (NPV_{jt} * TE_{jt}) \quad (1)$$

The main goal of this paper is to analyze IPD depend on retirement age, it is the reason why we use a methodologic of Schneider (2011) and IPD is calculate without influence change of GDP, inflation and the other effects of the economy. For population, distribution used a procedure of Gil et al. (2007). It means that we have 3 groups – people younger than 15 years, age cohort from 15 to RA (changing limit based on the scenario) and retired people (RA and higher). Gil et al. (2007) take into account the change during the year. It means that during every year changes are between a group of youth and working people, and also between working people and retired people. On the other hand, we neglect the probability of birth and death. It means age on age limit is divided because we have data on January 1, for example, RA is 65, it means that a group of retired people is composed of half people with 64 years and 65 years and over.

A general formula for total pension expenditure for year t ( $TE_t$ ) is composed of the number of expected retirement ( $NR_{jt}$ ) and average pension benefit or benefit, in this contribution is used the second method ( $B_{jt}$ ), both for year t (Rosner, 2003):

$$TE_{jt} = NR_{jt} * B_j * W_j \quad (2)$$

And the general formula of total pension revenue ( $TR_{jt}$ ) has four components, it is the number of expected worker ( $NW_{jt}$ ), wage ( $W_{jt}$ ) and contribution ( $c_j$ ):

$$TR_{jt} = NW_{jt} * W_j * c_j \quad (3)$$

Both formulas can be used for Czechia. For Denmark, we can use just the formula for total pension expenditure. A reason is that the Danes do not pay contributions to the PAYG system but private institutions. But “the pension account of Denmark” has revenues from the taxation of returns of pension assets. But there is a problem with a prediction of tax revenues. Firstly, the percentage of contribution rise, and it is different is according to the profession. Next, tax revenues are depending on returns, and the tax rate is 15.3% since 2012, and there is a system of tax relief (The Danish Ministry of Taxation, 2019). Hence, in this paper is used tax revenues as the amount on a person (a reason for divided tax revenues is that we have data of pension tax for households and private companies):

$$TR_{jt} = NW_{jt} * tw_{jt} + NR_{jt} * tr_{jt} \quad (4)$$

An overview of the variable and their indicator is in Table 2. We use the average for the years 2008 to 2018 when it is possible. The population projection is to 2060. CSO has a longer projection, but StatBank doesn't have it. Projection uses medium variant including migration. For calculation, IPD is used net present value that is 2%. This percent used for example by Holzman, Palacios and Zviniene (2001), but this contribution focuses on retirement age and its addiction to IPD.

Microsoft Excel and its functions are used for calculations of population distribution (people under 14 years, 15-RA and RA and more), pension expenditures from 2019 to 2060 and implicit pension debts for four scenarios in two countries based on formulas. The dispersion of data is negligible because the data respond to the economic cycle and it is the reason why we use the time period 2008-2018. Different time period for tax on yield of pension assets ( $tw_{jt}$  and  $tr_{jt}$ ) is used due to tax changes. Next, the limitation is data of population projection in Denmark, where data are available until 2060 (CSO has data until 2100).

Tab. 2 – An overview of the variable's description. Source: own research

Variable	Statistical indicator	Note	Available Time Period	Source
$NR_{jt}$	Number of retirement (RA+)	Population projection	2019-2060	CSO (2019), StatBank (2019)
$B_{jt}$	Benefit ratio	Average pension/average wage (%)	2008-2018	CSO (2019), StatBank (2019)
$NW_{jt}$	Number of workers	Number of population (15-RA) * Employment rate	2008-2018	CSO (2019), StatBank (2019)
$W_{jt}$	Wage	Actual (in national currency)	2018	CSO (2019), StatBank (2019)
$c_j$	Contribution	Constant contribution of wage (%)	2018	MFCR (2019)
$tw_{jt}$	Tax on yields of pension assets from private company	Tax revenue per worker person (DKK)	2012-2018	StatBank (2019)
$tr_{jt}$	Tax on yields of pension assets from households	Tax revenue per retirement (DKK per person)	2012-2018	StatBank (2019)

## 4 RESULT AND DISCUSSION

The results of this research show the development of total expenditures based on the scenario. The most expensive scenario is scenario A. Without a change in retirement age, Czechia has pension expenditure of about 10% in 2027 and over 12% in 2041. Scenario A has similar expenditures for Czechia and Denmark at the end of this period. Scenario B is better for public



finance, because higher retirement age than scenario A, means the reduction of expenditure about 2% in 2019 and the difference between these scenarios (A and B) grow on 2.6% in 2060. On the other hand, the differences are higher for Denmark (2.3% in 2019 and 2.7% in 2060). The third scenario is for Denmark before the reform of retirement age. The expenditures of the public pension system are the lowest in both countries about 0.1%. The last scenario is D, there is a gradually increase of retirement age from 65 to 68, it means that the starting point is the same for scenarios C and D (as the second part of scenarios B and C). Scenario D for Czechia has a public pension expenditure of 6% in 2019 and it is growing at 8.3% GDP. Scenario D for Denmark starts at 6.1% and ends at 7.9%.

Accumulation of total public expenditure (with time factor – net present value) show gross IPD, it is in the tab. 3. The table shows gross IPD for each scenario. Czechia has for scenario A IPD 314% GDP (before reform). But after reform, it is decreased by 89%. A sudden increase in the retirement age to 65 years means reduce by 7%. And the last version is just 189%. But for Czechia, there are important scenarios A and B. Reform of retirement age brought reduce of this implicit debt from the pension system.

When we compare this result with other research studies, then Kreidl and Schneider (1999) calculated 3 versions: for RA in 60 years for men and 53-57 for women with IPD 440%, 62 years/57-61 years 310% and RA in 65 years for everyone and IPD 170%.

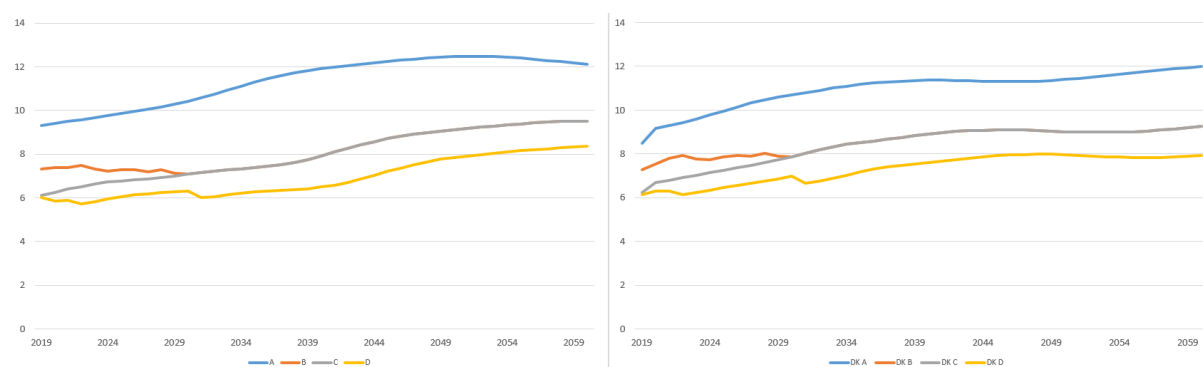

Fig. 3 – Public and private pension spending in Czechia and Denmark. Source: OECD (2019)

Their last version is similar to scenario C, but with a difference by 48%. But their research study is 20 years old and the pension system of Czechia was changed, just like the economy. And the next reason is a different methodology. On the other hand, there is the importance of retirement age for the pension system and the sensitivity of gross IPD on retirement age. Bezděk (2000) analysis several variants with economic development (basic, optimist and pessimist variants). When he uses the average replacement ratio, then his basic variants have IPD 308% in 2070. This variant can be partly compared with scenario A.

Tab. 3 – Gross and net IPD (in % GDP in 2018). Source: own research

Scenario	Gross IPD		Net IPD	
	CZ	DK	CZ	DK
A	314	304	98	258
B	225	238	-32	188
C	218	232	-41	181
D	189	202	-84	150

Denmark has similar IPD in every scenario, but just scenario A has lower debt as percent of GDP. The reason for this is in benefit ratio – the average benefit ratio for Czechia is 42% and 40% for Denmark. It means that Danish pensioners have a similar benefit ratio of public pension

(basic amount and other benefits) as pensioners in Czechia. Thus, these systems of pension have similar IPD.

Next part, net IPD is in Table 3 too. There is a problem with the prediction of revenues (as contributions or taxation of pension assets). It is probably the reason why net IPD is not often calculated. Total revenues in Czechia are from 8.2% to 9.7% GDP depending on the scenario. The situation in Denmark is different (from 1.4% to 1.5%), but one of the reasons is depending on the number of working people and pensioners.

Czechia can expect total revenue as accumulated percent of GDP between 216% and 273%. Denmark just can expect from 46 to 53% (based on the scenario). The next topic for research can be this problematic, f. e. when the employment rate decreased by one percent, then scenario A decreases by 3% and scenario D by 4%. This problem points to a limitation of the IPD, where is sensitivity to variables. Thus the economic situation (as GDP, employment rate) is important in the development of the IPD. Next, the main variable is population projection and the division into groups (under 14, 15-RA and RA and more) and any changes in the number and distribution of people between three groups.

Table 3 shows that Czechia is without debt for scenarios B, C, and D, but this “nonsexist” expect benefit ratio 42%, when the average wage decreases, then we cannot expect a decrease of a pension benefit. It is valid for the employment rate too. Denmark has a problem with predict of tax of pension assets. On the other hand, the system of Denmark expects financed by taxation (Andersen, 2015). And in Table 3, there is that actual valid scenario (D) has 150% of IPD, it is decreased by 31% against scenario C (Denmark before reform).

## 5 CONCLUSIONS

Ageing of the population is a very important process in the current time. This change of age structure influences many areas, apart from the area of health or social services, they are pension systems. The development of pension systems is a process that began in the 19th century and is not yet complete, and one of the reasons being the ageing population. This process is linked to the issue of financing pension systems. There are three basic methods – unfunded system (PAYG), funded system (FF) and their combination (NDC).

This paper focused on the relationship between the pension system (and its public expenditures and public revenues) and retirement age. The reason is public discussion about this issue. In this context, the method of IPD is used. There are analysed four scenarios (between and after reform in Czechia and Denmark) with different retirement ages.

Based on the above calculations is evident that the size of IPD (or future liabilities of state) is age-dependent. Thus, there are strong ties between the future public pension expenditure and retirement age as one of the components of the pension system.

The net IPD is very different from the gross IPD, but this part is based on two different approaches in these countries. Czechia prefers the first pillar with contributions as pension revenues and pension benefits as public expenditures, and this is the main income for pensioners. Danish approach is about two pillars. The first is without revenues (contributions) and it is financed by taxation. The second pillar is about contributions to pension companies, and returns of pension deposits are taxable.

Monitoring of future pension development is important especially in times of crisis because public pension expenditures are stable against pension revenues. Revenues are dependent on economic development, for example, employment rate and returns on securities.

In comparison with Czechia and Denmark is evident, that different pension design in these countries does not mean the different size of these IPD. The reason is the generosity pension system of Denmark, where is still gradually evolving the second pillar, but without changes in the first pillar.

Further research may focus on public pension revenues and their sensitivity to external influences in both systems. For Czechia pension revenues it can be employment rate, change the percent of the contributions, for Danish pension system it can be the development of returns based on the economic cycle.

## Acknowledgment

This paper was created within the project SGS-2017-004 'Finance and Sustainable Development from the Perspective of Theory and Practice' at the University of West Bohemia, Faculty of Economics.

## References

- Andersen, T. M. (2015). Robustness of the Danish Pension System. *CESifo Dice Report*, 13(2), 25-30. Retrieved from <https://www.ifo.de/DocDL/dice-report-2015-2-andersen-pension-june.pdf>
- ATP (2019). *Annual report 2018*. Copenhagen: ATP Group. Retrieved from <https://www.atp.dk/sites/default/files/the-atp-group-annual-report-2018.pdf>
- Baldwin, P. (1990). *The Politics of Social Solidarity: Class Bases of the European Welfare State 1875-1975*. Cambridge: Cambridge University Press.
- Bezděk, V. (2000). *Penzijní systémy obecně i v kontextu české ekonomiky (současný stav a potřeba reformy). II. díl*. Praha: ČNB. Retrieved from [http://invenio.nusl.cz/record/123899/files/nusl-123899\\_1.pdf](http://invenio.nusl.cz/record/123899/files/nusl-123899_1.pdf).
- Bikker, J. A. (2017). Is there an optimal Pension Fund Size? A scale economy analysis of administrative costs. *The Journal of Risk and Insurance*, 84(2), 739-769. doi: 10.1111/jori.12103
- Christiansen, N. F., & Petersen, K. (2001). The Dynamics of Social Solidarity: The Danish Welfare State, 1900-2000. *Scandinavian Journal of History*, 26(3), 177-196. doi: 10.1080/034687501750303846
- Conde-Ruiz, J. I., & González, C. I. (2015). Challenges for Spanish pensions in the Early 21th Century. *CESifo Dice Report*, 13(2), 20-24. Retrieved from <https://www.ifo.de/DocDL/dice-report-2015-2-conde-ruiz-et-al-pension-june.pdf>
- CSO (2019). *Veřejná databáze*. Retrieved from <https://vdb.czso.cz/vdbvo2/>
- Dundure, I., & Pukis, M. (2015). Criteria for Sustainability of Old-Age Pension System Based on the NDC Principles. *European Integration Studies*, 9(1), 86-99. doi: 10.5755/j01.eis.0.9.12798
- European Commission (2018). *The 2018 Ageing Report. Economic & Budgetary Projections for the 28 EU Member States (2016-2070)*. Luxembourg: Publications Office of the European Union. Retrieved from [https://ec.europa.eu/info/sites/info/files/economy-finance/ip079\\_en.pdf](https://ec.europa.eu/info/sites/info/files/economy-finance/ip079_en.pdf).

- Eurostat (2019). *Database*. Retrieved from <https://ec.europa.eu/eurostat/data/database>
- Gil, J., Lopez-Garcia, M. A., Onrubia, J., Patxot, C., & Souto, G. (2007). A Projection Model of the Contributory Pension Expenditure of the Spanish Social Security System: 2004-2050. *Hacienda Pública Española*, 182(3), 75-116. Retrieved from [https://econpapers.repec.org/article/hpejournl/y\\_3a2007\\_3av\\_3a182\\_3ai\\_3a3\\_3ap\\_3a75-116.htm](https://econpapers.repec.org/article/hpejournl/y_3a2007_3av_3a182_3ai_3a3_3ap_3a75-116.htm)
- Greve, B., & Hussain, M. A. (2019). *EUROMOD Country Report – Denmark 2015-2018*. Retrieved from [https://www.euromod.ac.uk/sites/default/files/country-reports/Y9\\_CR\\_DK\\_Final.pdf](https://www.euromod.ac.uk/sites/default/files/country-reports/Y9_CR_DK_Final.pdf)
- Gronholt-Pedersen, J. (2019). *Danes make welfare a hot election issue as cracks show in Nordic model*. Retrieved from <https://www.reuters.com/article/us-denmark-election-welfare-insight/danes-make-welfare-a-hot-election-issue-as-cracks-show-in-nordic-model-idUSKCN1SZ0IC>
- Harris, C. (2019). *Denmark general election 2019: All you need to know to understand the vote*. Retrieved from <https://www.euronews.com/2019/06/04/denmark-general-election-2019-all-you-need-to-know-to-understand-the-vote>
- Hinrichs, K., & Lynch, J. (2010). Old Age Pensions. In F. G. Castles, et al. (Ed.), *The Oxford Handbook of The Welfare state*, (353-366). Oxford: Oxford University Press.
- Holzmann, R., Palacios, R., & Zviniene, A. (2001). On the Economics and Scope of Implicit Pension Debt: An International Perspective. *Empirica*, 28(1), 97-129. doi: 10.1023/A:101096052
- Kane, C., & Palacios, R. (1996). The Implicit Pension Debt. *Finance & Development*, 33(2). Retrieved from <https://www.imf.org/external/pubs/ft/fandd/1996/06/pdf/kane.pdf>
- Kreidl, V., & Schneider, O. (1999). *Implicitní dluh penzijního zabezpečení je více než 300% našeho HDP*. Retrieved from <http://ies.fsv.cuni.cz/default/file/download/id/2000>
- Denmark (2019). *Lov om social pension nr. 1239. Bekendtgørelse af lov om social pension*. Retrieved from <https://www.retsinformation.dk/eli/lt/2017/1208>
- MFCR (2019). *Důchody*. Retrieved from <https://www.psfv.cz/cs/duchody>
- Nistico, S. (2013). Financing Pay-as-you-go Public Pension Systems: Some Notes in the Light of the Classical-type Theory of Income Distribution. *Review of Political Economy*, 25(3), 426-443. doi: 10.1080/09538259.2013.807670
- OECD (2019). *Pension Spending*. Retrieved from <https://data.oecd.org/socialexp/pension-spending.htm>
- Peková, J. (2011). *Veřejné finance: teorie a praxe v ČR*. Praha: Wolters Kluwer ČR.
- Rosner, P. G. (2003). *The Economics of Social Policy*. Cheltenham: Edward Elgar.
- Schneider, O. (2011). *Penzijní dluh: Břímě mladých*. Retrieved from [http://idea.cerge-ei.cz/documents/Studie\\_2011\\_02\\_Penze.pdf](http://idea.cerge-ei.cz/documents/Studie_2011_02_Penze.pdf)
- StatBank (2019). *StatBank Denmark*. Retrieved from <https://www.statistikbanken.dk/statbank5a/default.asp?w=1600>
- Surmanová, K. (2019). *Ministryně Maláčová chystá změnu důchodů. Hlavním problémem je podfinancovanost, říká*. Retrieved from [https://www.lidovky.cz/domov/zvysovat-duchodovy-vek-neni-reseni-rika-ministryne-prace-a-socialnich-veci-malacova.A190918\\_204239\\_in\\_domov\\_ele](https://www.lidovky.cz/domov/zvysovat-duchodovy-vek-neni-reseni-rika-ministryne-prace-a-socialnich-veci-malacova.A190918_204239_in_domov_ele)

Szule, B. (2013). Savings and Implicit Debt in Pension Systems. *Public Finance Quarterly*, 58(3), 334-348. Retrieved from [https://www.penzugyiszemle.hu/pfq/upload/pdf/penzugyi\\_szemle\\_angol/volume\\_58\\_2013\\_3/a\\_szuleb\\_2013\\_3.pdf](https://www.penzugyiszemle.hu/pfq/upload/pdf/penzugyi_szemle_angol/volume_58_2013_3/a_szuleb_2013_3.pdf)

The Danish Ministry of Taxation (2019). *Danish Income Tax Rates 2014-2017*. Retrieved from <https://www.skm.dk/english/facts-and-figures/danish-income-tax-rates-2014-2017>

UN DESA. (2017). *World Population Ageing 2017*. New York: UN, Department of Economic and Social Affairs, Population Division. Retrieved from [https://www.un.org/en/development/desa/population/publications/pdf/ageing/WPA2017\\_Report.pdf](https://www.un.org/en/development/desa/population/publications/pdf/ageing/WPA2017_Report.pdf)

Židek, B. (2019). *Adaptace místo reformy? Hrozí nízké důchody, práce do 69 let nebo obří deficit*. Retrieved from <https://www.novinky.cz/ekonomika/clanek/adaptace-misto-reformy-hrozi-nizke- Duchody-prace-do-69-let-nebo-obri-deficit-40297983>

## Contact information

### **Bc. Jan Pokorný**

University of West Bohemia, Faculty of Economics  
Univerzitní 8, 30100, Pilsen, Czech Republic  
E-mail: [pokorny@students.zcu.cz](mailto:pokorny@students.zcu.cz)  
ORCID: 0000-0002-3288-5080

### **Ing. Pavlína Hejduková, Ph.D**

University of West Bohemia, Faculty of Economics  
Univerzitní 8, 30100, Pilsen, Czech Republic  
E-mail: [pahejdu@kfu.zcu.cz](mailto:pahejdu@kfu.zcu.cz)  
ORCID: 0000-0003-3387-1198

doi: 10.7441/dokbat.2019.086

# THE IMPACT OF FISCAL DECENTRALIZATION ON THE ECONOMIC GROWTH IN EUROPEAN COUNTRIES, 2001-2017

*Tereza Powadová*

## **Abstract**

Almost everything what people buy today requires fewer working days than in the past. Economic growth is the process of increasing the amount of goods and services that can be earned with the same amount of work over time. Fiscal decentralization allows to increase the efficiency of services and goods provided by local authorities and autonomy of higher territorial self-governing units making their decisions better adapted to the conditions of the given site and preferences. This assumption is based on the traditional approach of the theory of public finances, which results from the space limitation and the local character of some public goods and services. Fiscal decentralization is defined above all as an increase in tax and expense responsibilities of the territorial level of government. Transfer of competences to regional and municipal levels ensures greater efficiency and effectiveness. This paper is dedicated to the econometric model, where the impact of fiscal decentralization on economic growth is examined. Expenditure fiscal decentralization is envisaged in the model as an explanatory variable and a set of control variables. Overall, the model is examined on 360 observations over the 26 European countries in years 2001 – 2017. The model is solved by panel regression using least squares estimation. However, the coefficient of determination says that the model is explained by only 25%. The result of the solution is not completely competent; therefore, it is necessary to add more variables or another estimated method.

**Keywords:** *Fiscal decentralization, economic growth, local government revenue and expenditure, panel regression, least square method*

## **1 INTRODUCTION**

The term “fiscal decentralization” refers to an increase in taxing and/or spending responsibilities given to subnational jurisdictions. In many cases of fiscal decentralization, additional layers such as states, provinces, and regions are created. A related term, “fiscal federalism,” is an advanced form of fiscal decentralization.

Until recent years, countries seemed to be divided into two relatively distinct groups: the “federal” and the “unitary.” In federal countries such as Argentina, Australia, Brazil, Canada, Germany, India, Nigeria, Russia, and the United States, subnational governments have important and independent responsibilities for public spending and taxation. These responsibilities are often outlined in each country’s constitution, which explicitly recognizes the existence and the powers of the subnational jurisdictions. In unitary countries such as France, Japan, and Chile, on the other hand, spending and taxing decisions are made mostly at the level of the national government, although some spending may be carried out by decentralized agencies or institutions acting on its behalf. This form of administrative decentralization should be distinguished from fiscal decentralization that generally includes some decentralization of political decisions (Tanzi, 2001).

The aim of this paper is to find out by means of regression analysis the impact of fiscal decentralization on economic growth in the years 2001 – 2017 for the European Union countries. The first chapter is devoted to an overview of literature and the relation of the topic to the future dissertation. It deals with the impact of fiscal decentralization on economic growth.

The second chapter is devoted to the mathematical formulation of the method in the field and the formulation of individual tests. In the third chapter there is the application of solving the problem using the model. Verbal description of the problem followed by mathematical formulation, model quantification using input data, problem and result solution and its interpretation.

## **2 THEORETICAL BACKGROUND**

To tease out the relationship between fiscal decentralization and economic growth, it is useful to refer to Musgrave (1959), who has indicated the main economic functions of government should focus on: macroeconomic stability, efficiency in public finances and guaranteeing an equal income distribution. Economic performance and growth is then indirectly affected though the impact of fiscal decentralization on these three factors. Macroeconomic stability is done through fiscal and monetary policy, which can imply some deficit spending. The efficiency with which this can occur depends on various kinds of multipliers and whether one holds a neo-Keynesian or a neo-Classical view of the world. But the ability of a government to engage in counter-cyclical stabilization policy and its implications for unemployment and hence the structural or natural rate of unemployment can have an impact on the natural rate of output and hence on long run economic growth (Konings, 2011).

It is clear from neoclassical growth theory that the key determinants of economic growth are technological progress and the process of capital accumulation, which in turn depends on savings. Other factors may influence these processes, such as infrastructure, human capital accumulation and institutional design. Oates (1993) conjectured that better targeting of growth-enhancing infrastructure investment under federalism could raise an economy's growth rate, which triggered a series of empirical papers with mixed results. But only recently, a more systematic theoretical framework to think about these issues has been developed (e.g. Brueckner, 2006). The key mechanism is that federalism affects the incentive to save and hence the capital accumulation in the economy, which affects growth. Brueckner (2006) shows that decentralization allows public good levels to be tailored to suit the differing demands of young and old consumers in different jurisdictions, which increases their incentive to save. This in turn leads to an increase in investment in human capital and eventually to faster economic growth (Konings, 2011).

From the decentralization theorem of Oates, we can also infer that under decentralization efficiency should improve. Martinez-Vazquez and McNab (1997) argue that better matching individual's preferences could have an additional effect through increased work effort, savings and investment, which in turn leads to higher economic growth. Likewise, if the local provision of public goods improves the technical or producer efficiency by offering better quality and larger quantities of the public good, it can foster innovation in the production and supply of public goods. This in turn affects economic growth positively.

Jílek (2015) is writing about 18 OECD - EU countries in ages 1995 – 2013. On the other hand, Szarovská (2014) is writing about 17 unitary EU countries in ages 1995 – 2012. Thiesen (2003) describes fiscal decentralization and economic growth of high-income OECD economies using annual data for a period 1973 – 1998. This paper is focusing on 26 European countries in ages 2001-2017.

## **3 METHODOLOGY**

Annual data for 28 countries in 2000 – 2018 were used for the paper, i.e. 19 observations. The data contains a measure of economic growth as an explained variable, a measure of fiscal

decentralization as an explanatory variable, and a set of control variables. The control variables are the Gini coefficient, the percentage of persons educated at secondary and tertiary level, the rate of gross investment by households, the harmonic indicator of consumer prices and unemployment. The data are processed from the statistical portal Eurostat. The model is calculated using EViews 11 software. The method used is the least squares method for panel regression. The software used data for 17 periods and 26 countries because the data lacked many country values. Overall, the model is examined on 360 observations over the years 2001 – 2017. The level of significance is selected. Robust standard deviations were used for the calculation.

In terms of economic growth, real GDP per capita, or its natural logarithm, was used:

$$Y = \ln(GDP)_t - \ln(GDP)_{t-1} \quad (1)$$

The measure of fiscal decentralization is calculated as the ratio of sub-central government expenditure to total consolidated government expenditure:

$$X_1 = \frac{\text{Local government expenditure}}{\text{General government expenditure}} \quad (2)$$

Percentage of persons educated at secondary and tertiary level for the 15-64 age group, both men and women. These are data on secondary and tertiary education that have been successfully completed by individuals in the population. The classification of educational activities is based on the International Standard Classification of Education (ISCED). Data up to 2013 are classified according to ISCED 1997 and data from 2014 according to ISCED 2011 (coding of educational attainment). This variable is selected by the Bodman and Ford study (2006). Davoodi and Zou (1998), Woller and Phillips (1998), Akai and Sakata (2002), Meloche (2004) and Thornton (2007) use it in various modifications).

The Gini coefficient is mostly used as a measure of inequality in the distribution of personal income or wealth. It varies between 0 and 1. A low value indicates a more even distribution (0 corresponds to perfect equality), while a high Gini coefficient indicates a more uneven distribution (1 corresponds to a perfect inequality, where income is concentrated in the hands of one individual). Gini coefficient is also used in the study by Xie (1999) and Akai and Sakata (2002).

The rate of gross investment by households (including non-profit institutions serving households) is defined as gross fixed capital formation divided by gross disposable income, adjusted for the net change in pension rights. Investments of households consist mainly of the purchase and renovation of flats. This coefficient is used by Woller and Phillips (1998), Zhang and Zou (1998) and Meloche (2004).

According to Zhang and Zoua (1998), inflation is also one of the control variables in the model. The inflation rate is calculated using the harmonic indicator of consumer prices:

$$X_t = HCIP_t - HCIP_{t-1} \quad (3)$$

As with Stansel (2005), this model uses the unemployment rate as one of the control variables. The unemployment rate is the number of unemployed persons expressed as a percentage of the workforce (total number of employed and unemployed) as defined by the International Labour Office (ILO). Unemployed persons are persons between 15 and 74 years of age who meet all three conditions: (1) are out of work during the reference week; (2) are available to begin work within the next two weeks; and (3) have been actively seeking work in the last four weeks or have already found a job that should start in the next three months. The indicator monitors high and persistent unemployment rates and helps to better understand the potential severity of macroeconomic imbalances (Eurostat, 2019).



## 4 RESULTS

Figure 1 shows an econometric model with all the variables from the EViews software. These results are further developed in the project.

Dependent Variable: GDP				
Method: Panel Least Squares				
Date: 06/18/19 Time: 12:02				
Sample (adjusted): 2001 2017				
Periods included: 17				
Cross-sections included: 26				
Total panel (unbalanced) observations: 360				
White diagonal standard errors & covariance (no d.f. correction)				
Variable	Coefficient	Std. Error	t-Statistic	Prob.
MFD	-0.194912	0.100357	-1.942193	0.0530
EDUCATION	-0.001173	0.000650	-1.804866	0.0720
GINI_COEFF_	0.001506	0.002096	0.718274	0.4731
GROSS_INVESTMENT_RATE_HO	0.002571	0.001603	1.603643	0.1098
INFLATION	0.005854	0.002186	2.677430	0.0078
UNEMPLOYMENT	-0.003832	0.001689	-2.268243	0.0240
C	0.129011	0.082122	1.570960	0.1172
Effects Specification				
Cross-section fixed (dummy variables)				
R-squared	0.239211	Mean dependent var	0.042048	
Adjusted R-squared	0.167307	S.D. dependent var	0.061243	
S.E. of regression	0.055886	Akaike info criterion	-2.846335	
Sum squared resid	1.024407	Schwarz criterion	-2.500904	
Log likelihood	544.3403	Hannan-Quinn criter.	-2.708985	
F-statistic	3.326814	Durbin-Watson stat	1.591499	
Prob(F-statistic)	0.000000			

Fig. 1 – Econometric Model in EViews Software. Source: own research

The mathematical formulation of the model looks like this:

$$\begin{aligned}
 GDP_{it} = & \beta_1 + \beta_2 MFD_{it} + \beta_3 education_{it} + \beta_4 gini_{coef}_{it} \\
 & + \beta_5 gross\_investment\_rate_{it} - \beta_6 inflation_{it} \\
 & - \beta_7 unemployment_{it} + \varepsilon_{it} \quad i = 1, \dots, 26; t = 1, \dots, 17
 \end{aligned} \tag{4}$$

*GDP* = measure of economic growth; *MFD* = measure of fiscal decentralization; *education* = percentage of persons educated at secondary and tertiary level; *gini\_coef* = gini coefficient; *gross\_investment\_rate* = gross investment of households; *inflation* = rate of inflation; *unemployment* = unemployment rate

According to the theory, there are + and - signs for individual indicators. Positive signs represent a positive relationship to economic growth. On the contrary, negative signs are negative. This can vary in short and long periods. For example, inflation is negative in the short term, but vice versa in the long term.

### Least squares estimation

$$\begin{aligned}
 GDP_{it} = & 0,13 - 0,19MFD_{it} - 0,001education_{it} + 0,002gini_{coef}_{it} \\
 & + 0,003gross\_investment\_rate_{it} + 0,006inflation_{it} \\
 & - 0,004unemployment_{it} + \varepsilon_{it} \\
 R^2 = & 0,239 \quad \alpha = 0,06
 \end{aligned} \tag{5}$$

This equation implies that expenditure fiscal decentralization has a negative relationship to economic growth. The same is true for variable education. According to theory, there should be a positive relationship. However, the countries of the European Union do not have much differences in education, so this may have an impact on this indicator. Another sign that contradicts judgment is inflation. However, according to the Phillips curve theory, if

unemployment is negative, inflation is positive. The overall model is explained by only 24%, which is not very adequate and needs to be modified.

Figure 2 shows the regression model residues in a scatter plot. It is clear from the graph that the residues are essentially independent of  $Y_{it}$ , indicating that the random component is constant and therefore heteroscedasticity is not present.

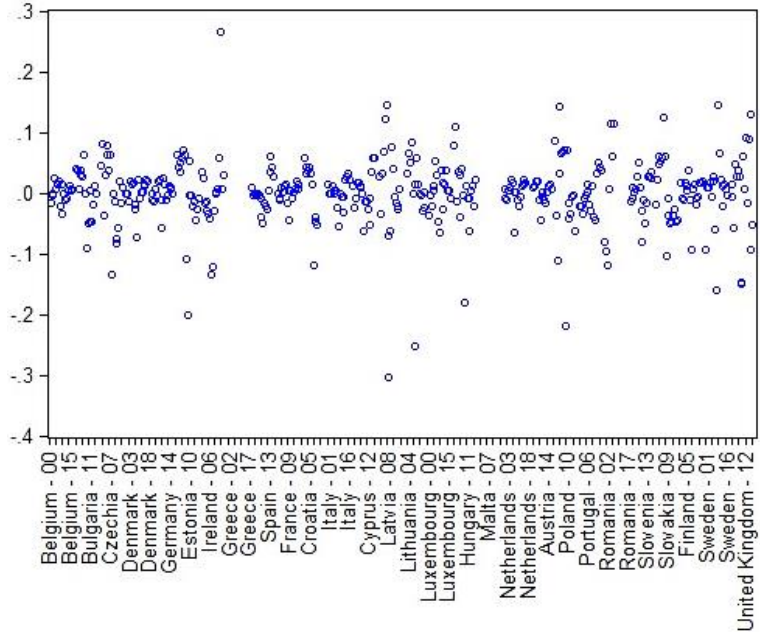

Fig. 2 – Scatter plot of regression model residues. Source: own research

This model is not very significant and has many coefficients that are not statistically significant. Therefore, another model is used where the Gini coefficient is omitted. This variable is omitted because it is the least significant of all control variables. Figure 3 shows a new econometric model omitting the Gini coefficient control variable.

Dependent Variable: GDP  
 Method: Panel Least Squares  
 Date: 06/18/19 Time: 12:03  
 Sample (adjusted): 2001 2017  
 Periods Included: 17  
 Cross-sections included: 26  
 Total panel (unbalanced) observations: 418  
 White diagonal standard errors & covariance (no d.f. correction)

Variable	Coefficient	Std. Error	t-Statistic	Prob.
MFD	-0.115350	0.083623	-1.379405	0.1686
EDUCATION	-0.001329	0.000508	-2.612940	0.0093
GROSS_INVESTMENT_RATE_HO	0.002124	0.001448	1.466983	0.1432
INFLATION	0.005566	0.002006	2.774548	0.0058
UNEMPLOYMENT	-0.003792	0.001439	-2.634758	0.0088
C	0.172194	0.048636	3.540441	0.0004

Effects Specification

Cross-section fixed (dummy variables)			
R-squared	0.271444	Mean dependent var	0.045519
Adjusted R-squared	0.214967	S.D. dependent var	0.061394
S.E. of regression	0.054397	Akaike info criterion	-2.913761
Sum squared resid	1.145130	Schwarz criterion	-2.614479
Log likelihood	639.9760	Hannan-Quinn criter.	-2.795448
F-statistic	4.806263	Durbin-Watson stat	1.500604
Prob(F-statistic)	0.000000		

Fig. 3 – Econometric model without Gini coefficient. Source: own research

The new least squares estimate equation looks like this:

$$\begin{aligned}
 GDP_{it} = & 0,172 - 0,115MFD_{it} - 0,001education_{it} \\
 & + 0,002gross\_investment\_rate_{it} + 0,006inflation_{it} \\
 & - 0,004unemployment_{it} + \varepsilon_{it}
 \end{aligned} \tag{6}$$

$$R^2 = 0,271 \quad \alpha = 0,06$$

The coefficients did not change in the equation, only slightly the coefficient of fiscal decentralization. The statistical significance of individual coefficients has changed. The rate of fiscal decentralization has become very insignificant, so it will be without \*. Education is now statistically very significant with three \*\*\*, domestic investment coefficient is insignificant, inflation coefficient is three \*\*\* and unemployment is also very important with three \*\*\*. The index of determination increased to 0.271, which is still very low.

Figure 4 shows the histogram of the new model. The figure shows that model data is not normally distributed. This is also evidenced by a skew coefficient of 0.896. A negative skew means that values to the left of the diameter are more distant than the right.

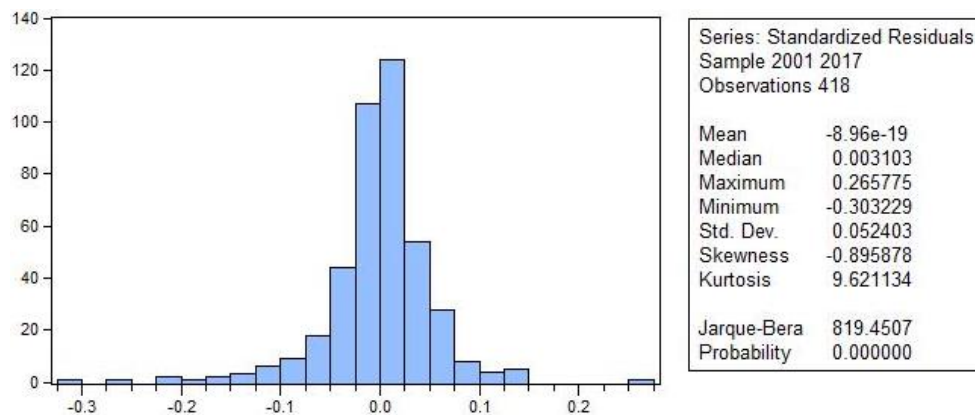

Fig. 4 – Histogram. Source: own research

Robust standard deviations were used in the model. The overall model was tested by F-test and individual coefficients by student's t-test. Many coefficients are not statistically very significant and need to be adjusted. The result of this panel regression is that the model was explained by only 25%. Which is not adequate. There are a lot of inaccuracies in the model and it needs to be better modified.

## 5 CONCLUSION

Fiscal decentralization is the transfer of authority and responsibility for carrying out public functions from the central government level to the lower government level. This project deals with a model where the impact of expenditure fiscal decentralization on economic growth is examined.

The aim of this paper was to create a model of panel regression, describe it by mathematical formulations and then verify the model. The model data comes from the Eurostat statistical database and the regression was calculated using EViews 11 software. The software selected data with 17 observations for 26 countries from the original set of 19 observations and 28 countries.

The results of estimates for inflation and unemployment are according to the theory. The results of the estimation of the education indicator contradict the theory, which may be since there are no marked differences in education in the European Union. The big minus of this model is its coefficient of determination, which says that the model is explained by only 25%. Although the

model is not very statistically significant, it is good to point out the analysis of the model residues. When the random component is constant and heteroscedasticity is absent.

The next research will include more control variables. The impact of other fiscal indicators, such as tax decentralization, will also be examined. Finally, the model will be solved for more countries outside the EU.

### Acknowledgements

This paper was financially supported within the VŠB–Technical University SGS grant project No. SP2019/119 (Econometric Modeling of Fiscal, Monetary and Financial Aspects of the European Economies).

### References

- Agung, I. G. N. (2014). *Panel Data Analysis Using EViews*. Chichester: Wiley.
- Akai, N., & Sakata, M. (2002). Fiscal decentralization contributes to economic growth: evidence from state-level cross-section data for the United States. *Journal of Urban Economics*, 52(1), 93-108. doi: 10.1016/S0094-1190(02)00018-9
- Brueckner, J. K. (2006). Fiscal federalism and economic growth. *Journal of Public Economics*, 90(10-11), 2107-2120. doi: 10.1016/j.jpubeco.2006.05.003
- Davoodi, D., & Zou, H. (1998). Fiscal decentralization and economic growth: a cross-country study. *Journal of Urban Economics*, 43(2), 244-257. doi: 10.1006/juec.1997.2042
- Eurostat (2019). Unemployment rate. Retrieved from <https://ec.europa.eu/eurostat/web/products-datasets/-/tipsun10>
- Hančlová, J. (2012). *Ekonomrické modelování*. Praha: Professional Publishing.
- Hendl, J. (2015). *Přehled statistických metod: analýza a metaanalýza dat*. Praha: Portál.
- Jílek, M. (2015). Factors of Tax Decentralization in OECD-Europe Countries. *European Financial and Accounting Journal*, 10(2), 33-49. doi: 10.18267/j.efaj.140
- Konings, J., & Torfs, W. (2001). *Fiscal Federalism, Tax Competition and Economic Agglomeration*. Retrieved from <https://feb.kuleuven.be/VIVES/oud/oudesite/PUBLICATIES/INTPUBLICATIES/3-konings-en-torfs-from-fiscal-federalism-proef-3.pdf>
- Martinez-Vazquez, J., & McNab, R. (1997). Fiscal decentralization, economic growth, and democratic governance. *Conference on Economic Growth and Democratic Governance*, Washington, DC.
- Meloche, J., Vaillacourt, F., & Yilmaz, S. (2004). Decentralization or Fiscal Autonomy? What does really matter? Effects on growth and public sector size in European transition countries. *World Bank Policy Research Working Paper*, 3254. Retrieved from <https://ssrn.com/abstract=524903>
- Musgrave, R. A. (1986). *Public finance in a democratic society*. New York: University Press.
- Oates, W. (1993). Decentralization and economic development. *National Tax Jour*, 46(2), 237-243. Retrieved from <https://ideas.repec.org/a/ntj/journal/v46y1993i2p237-43.html>
- Ramík, J. (2007). *Statistika*. Opava: Slezská univerzita v Opavě.

- Szarovská, I. (2014). Fiscal Decentralisation and Economic Development in Selected Unitary European Countries. *European Financial and Accounting Journal*, 9(1), 22-40. doi: 10.18267/j.efaj.113
- Tanzi, V. (2002). Pitfalls on the Road to Fiscal Decentralization. In E. Ahmad & V. Tanzi (Ed.), *Managing Fiscal Decentralization*. London: Taylor & Francis.
- Thiessen, U. (2005). Fiscal decentralisation and economic growth in high income OECD countries. *Fiscal studies*, 61(1), 64-70. doi: 10.1111/j.1475-5890.2003.tb00084.x
- Woller, G. K., & Phillips, K. (1998). Fiscal decentralisation and IDC economic growth: An empirical investigation. *Journal of Development Studies*, 34(4), 138-148. doi: 10.1080/00220389808422532
- World Bank (2019). *The World Bank database*. Retrieved from <https://www.worldbank.org/>
- Xie, D., Zou, H., & Davoodi, H. (1999). Fiscal decentralization and economic growth in the United States. *Journal of Urban Economics*, 45(2), 228-39. doi: 10.1006/juec.1998.2095
- Zhang, T., & Zou, H. (1998). Fiscal decentralization, public spending and economic growth in China. *Journal of Public Economics*, 67(2), 221-240. doi: 10.1016/S0047-2727(97)00057-1

### Contact information

#### Ing. Tereza Powadová

VSB - Technical University of Ostrava, Faculty of Economics  
Havlíčkovo Nábřeží 38a, 70200, Ostrava, Czech Republic  
E-mail: tereza.powadova@vsb.cz  
ORCID: 0000-0002-4449-8301

doi: 10.7441/dokbat.2019.087

# SENSORY MARKETING IN THE DIGITAL ERA: ANALYZING THE GLOBAL MARKETING ENVIRONMENT AND CONSUMER CULTURE

*Tomáš Rebič, Elena Horská*

## **Abstract**

The aim of this paper is to present what sensory marketing means in global marketing environment and consumer culture. The most significant are cultural value and digital technology, which influence new consumer values, behaviour and new strategies for dialogue and communication. The article also tries to understand how businesses use the five human senses (smell, sound, sight, taste and touch) and to develop sensory strategies and sensory experiences for consumers. The aim of this study is to describe five human senses in global marketing environment and consumer culture.

*Keywords: sensory marketing, sensory experiences, sensory strategies, digital technology*

## **1 INTRODUCTION**

Bartels (1970) expressed marketing as: Marketing was a discovery since “marketing” is recognized as an idea and not just as an activity... Before the idea was created to which the term “marketing” was applied, the simple task had just been called “trade,” “distribution,” or “exchange.” Consumer marketing as a discipline today covers a variety of areas, which together put the consumer at the centre, regardless of whether it relates to mass marketing, relationship marketing, service logic, consumer behaviour, or branding. The development that has taken place over the last few decades has increasingly come to focus on a theoretical and conceptual development, where leading concepts, such as interactions, relationships and value creation are highlighted.

Three new emerging fields belong to the new marketing paradigm consist of consumer experiences, network and sustained marketing. The first emerging field is about consumer experiences and takes as its starting point that consumption is the fundamental process in marketing. Furthermore, consumption is related to concepts, such as benefit, satisfaction and value, leading to the conclusion that the consumer’s perceptions and experiences are particularly prominent in a consumer culture with the presence of digital technology and knowledge products. That satisfaction of needs that consumers are seeking through consumption is filtered through the five human senses, namely, sight, sound, smell, touch, and taste. The senses are the tools that enable consumers to experience the world.

The digital world provides endless possibilities to create experiences or perceptions, which at the same time means that the physical world, as another world, will lose its importance for many individuals. In this context, the perceptions from virtual experiences become prime and help to create new opportunities for marketing. Marketing and nanotechnology, as a phenomenon, are discussed, where the importance of materials, tools, and systems with new characteristics can help to enhance the consumption experience or perception of a product. It is emphasized that the application of new nanotechnology is about to change many consumer products, such as cars, computers, tires, sunglasses, and tennis rackets, to name a few recent examples. Furthermore, it is presented that nanotechnology will be able to develop tools that will directly be able to influence our taste buds and taste sensations, as well as create new scent sensors and provide fragrance sensations. (Hultén, 2015).

## 2 SENSORY MARKETING

The word sensory means relating to sensation or the senses. Sensory marketing, as an approach in consumer marketing, includes the consumer's senses and affects their behaviour. Sensory aspects of products (touch, taste, smell, sound and look of products) affect our emotions, memories, perceptions, preferences, choices and consumption of these products. Only recently, firms started to look at these sensory aspects. Our senses remain an elemental part of us and if we make a product more positively sensorial, it is more likely to stay that way. We react immediately and subconsciously to our senses.

Sensory marketing contributes to an individual's final purchase and consumption experience; it focuses on the accomplishment of sensory experience. It will persist since senses can affect the marketing of products in many ways. Sensory marketing has become a synthesis of what current society requires from a firm and what a firm can do to create sensory experiences with the help of the five human senses.

People are influenced emotionally and cognitively by positive and negative sensory experiences in purchase and consumption process. In a global consumption culture, firms should develop sensory branding strategies. Five sensorial strategies emphasize the human senses as the centre of a firm's sensory marketing. Human senses, the brand, and experience logic are important factors in sensory marketing.

By applying a visual sensory strategy, a brand's identity is expressed visually and is often expressed through advertising, design and style or by visual and verbal identities in the advertising context, as well as through electronic media, websites or people. Brand's identity in auditory sensory strategy, is expressed in the form of sound. Consumer's feelings for various products and services are attracted via music, voices or other sounds. With the help of an olfactory sensory strategy, brand's identity can be expressed atmospherically, where the role of scent is to create awareness. By applying a tactile sensory strategy, the role of touch is to create sensory experiences. In addition, by using a taste sensory strategy, brand's identity can be expressed gastronomically, where the role of taste is to create memorable sensory experiences (Hultén, 2017).

The five human senses are of crucial importance for an individual's experience of different purchase and consumption processes. It is through the senses that every individual becomes conscious of and perceives firms, products, and brands. Of the five human senses, the sight sense has so far dominated marketing practice. There is no doubt that the other human senses – smell, sound, taste, and touch – have been neglected for a long time, despite their importance when an individual considers and decides about a product or a brand. Growing interest in sensory marketing among practitioners, consultants, and researchers means that all five human senses are today receiving increased attention. More often than not, the interest is in making customers aware of a product or a brand in order to reach tactical, short-term sales targets.

The present development of sensory marketing illustrates the emergence of a new epoch in marketing, one in which the five senses will be at the centre of marketing strategy and tactics. For that reason, it becomes more important for firms – whether they are selling traditional consumer goods or a service – to affect and influence customers in new, provocative, imaginative ways in order to seize grab hold of the human senses. (Hultén, Broweus & van Dijk, 2009)

### 2.1 Sense of sight

It is one of the strongest senses of human being with respect to sensory stimuli and sensory perception. Eyes are responsible for the collection of approximately 70% of all sensory

information the brain needs. Visual perception means perceiving and interpreting various visual impressions and compiling them into meaningful whole. For an individual, it means seeing and understanding what one saw. It is an important part of brain's cognitive process, which is the basis for decision and action.

Vision is the primary way to make a connection to the surroundings and the consumption experience, which emphasizes the importance of visual consumption. The growing importance of the sense of sight is increasingly reflected in the number of digital photos, movies, photographs, websites, television and internet advertising. More and more companies and consumers also use social media, like Facebook, Instagram, Twitter and others for commercial and social activities. Visual experience can be decisive in determining whether consumers will be attracted to and aware of a product or a brand. Advertising and commercials, as marketing stimuli, have been focused on creating awareness around a product, which should be able to lead to an increased interest among consumers and a subsequent purchase. Visual stimuli, such as design, shape, colour and packaging contribute to build and establish strong producer and retailer brands and are considered to be natural part of branding strategy for a company. Lighting is another example of visual stimuli. It positively affects consumer's visual attraction to what is included in the service environment (Hultén, 2015).

## **2.2 Sense of sound**

Sound affects our mood and psychological state, alerts us to danger and promotes peace of mind for the soul. It is used to communicate messages and create awareness about a firm and its products mainly in television or radio commercials, where music is often intended to dramatize or enhance an idea. Sound is important for understanding arguments, opinions and feelings. In sensory marketing, this can be realized through sound logotypes, jingles, voices, music and sound brand. These affect our perceptions in relation to credibility and trust, positive feelings, purchasing and time of stay. Music reminds many people of the world they live in and their everyday life, expressed in a range from the deepest sadness to true happiness. It evokes a mood that is directly transferable to a brand. Every day, people hear a great number of sounds that convey what is happening in their environment. The first sounds that people notice, are those with high frequencies, but many sounds can affect us even without noticing them. We do not limit ourselves to experiencing sound and silence, we also give sound meaning by interpreting, communicating and expressing ourselves through sound.

There is a difference between hearing and listening. Hearing involves the ear receiving sound without our taking notice. Listening requires that we hold back our thoughts and speech and consciously focus on the sound. The sounds perceived as important are the ones we choose to listen to (Hultén, 2015). British sociologist DeNora (2001) concluded that music is considered as one of the most powerful tools to bring about emotions and feelings in people. The researcher conducted a ground-breaking study on how individuals with completely different backgrounds and subcultures use music in their lives. She found that British women primarily use music in everyday life to regulate, enhance and modify their emotional states. These women considered music to be one of the most effective tools for managing emotional labour required to maintain a positive emotional state, such as relaxation or enthusiasm and to eliminate a negative emotional state, such as stress or fatigue. There is clear scientific evidence that music has an overall positive impact on consumer's affections, cognitions and actual behaviours in environment.

## **2.3 Sense of smell**

Smell is strongly associated with emotional and cognitive reactions in a person. The function of the sense of smell directly affects individual's associations and memories because of the



reactions of the emotional life. It plays an important role in people's everyday lives. Scent marketing is very well known when companies use scents to create scent experiences. Scents create a personalized meaning for individuals and have a tendency to be associated with events, environments, experiences, objects, items and other people. Positive emotions, such as being happy or in love, are associated with pleasant scents, whereas negative emotions, such as feeling lonely or being sad, are associated with unpleasant scents. Scents can be used to create awareness around a product or a brand in the short term in a store or advertising campaign. However, scents can also be used to differentiate position and strengthen brand's image in the long term. Introduction of different scents with regard to both, brand and service environments, affect sales and profitability. Thanks to, so called nebulization technology, it has become possible to spray liquid aerosols in different service environments, making the practical application of fragrances easier to implement (Hultén, 2015).

## **2.4 Sense of touch**

The importance of the sense of touch has been recognized for centuries. Aristotle believed that touch mediated all sense perception, even vision (Siegel, 1970). It was thought that invisible particles bombarded the surface of the body to convey smell, taste and sound. Although studies of touch may involve any tactile surface on the human body, in marketing, research has centred on the hands as the primary source of input to the perceptual system. Therefore, in marketing, active seeking and perception by the hands is called haptics. The sense of touch is often called the near sense or the proximal sense. Only with the sense of touch, people feel things that actually encounter them. The haptic system is particularly adept at encoding the object properties corresponding to texture, hardness, and temperature and weight information. In consumer behaviour, products are touched for many different reasons, not only to ascertain material properties.

There are four distinct types of touch in consumer behaviour: (1) Touch to Purchase, (2) Touch to Obtain Non-Haptic Product Information, (3) Touch to Obtain Haptic Product Information, and (4) Hedonic touch. The first three types of touch assume a consumer is engaged in goal-directed, problem-solving, repurchase behaviour. Therefore, the consumers are touching products as a means to an end, possibly purchase. The fourth type is hedonic touch, where touch is an end in itself with the focus being the sensory experience of touch (Peck, 2010).

Tactile marketing clarifies the interaction between a firm and its customers. "Tactile" describes the transmission of information or feelings when products and brands are touched physically or virtually. This builds touch perceptions and touch experiences of an individual to increase the physical and psychological interaction between a firm and that individual. Tactile marketing then, can be seen as a way to express the identity and values of a brand. There are individual differences in touching and some individuals always prefer to touch a brand before purchasing it. Such individuals, who have a higher need for touch, have stronger preferences based on their motivation, compared with others with lower need for touch.

People use their ability to touch and examine things to get a feeling for something by either individually touching or being touched by a brand. It is clear, that a brand is affected if customers can touch a product and receive sensory information. The desire to touch can also be seen as problem solving, as well as, fun, exciting and creating joy through positive brand experiences. The touch sense can be called our three-dimensional sense (Hultén, 2015).

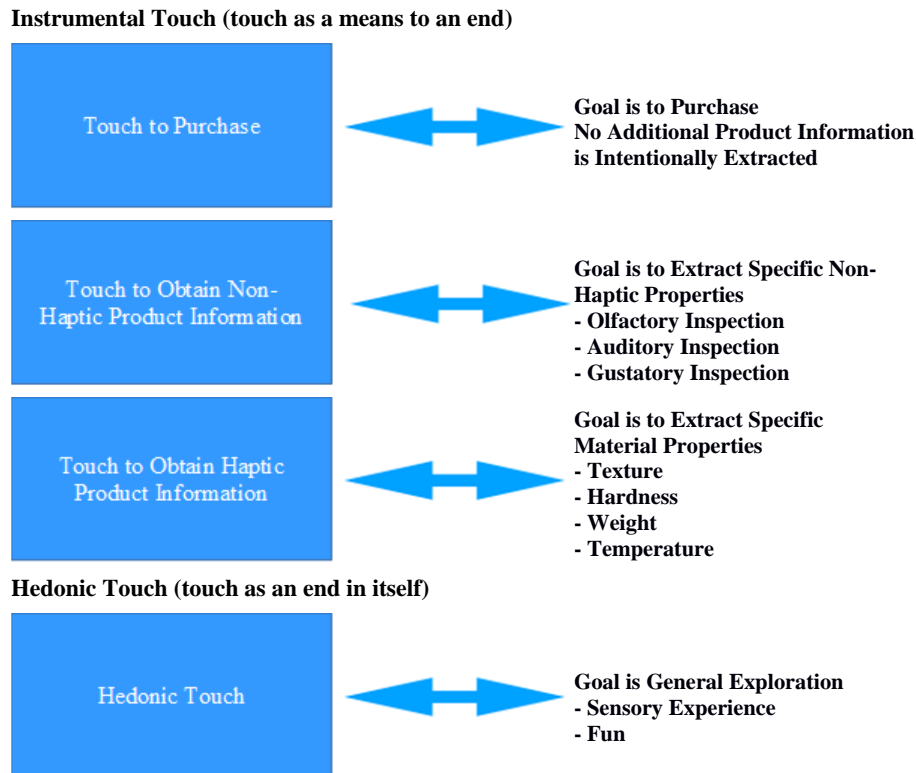

Fig. 1 – A Taxonomy of Touch in Consumer Behaviour. Source: Peck (2010)

## 2.5 Sense of taste

Taste sense is the most social sense and affects people's mood. The taste a person perceives includes much more than just the actual taste itself. The concept of taste is effectively an expression for the individual's supreme sensory experience, as what is eaten and drunk, is seen as the whole experience of a product, even its smell, sound, appearance and texture. Therefore, taste is the entire sensory experience that results from the product being put into the mouth. Setting where food and beverages are consumed is very important too. In sensory marketing, it is necessary to create an interesting, exciting and pleasing setting. Taste experience and brand image must harmonize with the identity of the brand. Offering taste experience makes people smile, is energizing and results in more positive body language. This enables interaction with the individual and possibility for a firm to increase sensitivity to its message (Krishna, 2012). Physical taste interacts with olfactory and tactile senses, offering different taste perceptions for individuals. Colours have significant influence on taste experience too. Colour might distinguish the flavours of a drink, demonstrating how aesthetic stimuli impact on taste perception. Here, vision interacts with taste.

## 3 CONCLUSION

Sensory marketing requires a comprehensive approach involving all five human senses (smell, sound, sight, taste and touch). In global consumption culture, it is evident that, people use more than one sense in their sensory experiences. In terms of perceptions, it is necessary to know how each sense works in different cultures. Each of the five human senses affects human behaviour and is seen as a point of departure for a firm's sensorial strategies and customer treatment. Sight sense is prevailing in practice, but other human senses will come to receive more attention in marketing in the future. Human senses are the centre of sensory marketing, so the firms have to be innovative, they need to establish connections to customers and activate

all five human senses in individuals by getting closer and deeper into customer's minds and hearts. Each individual is free to look for ideas, products or brands that can contribute to shaping identity, lifestyle and self-image. By this approach, firms can be more successful and profitable thanks to sensory marketing. Development of contemporary society is characterized by ongoing cultural value and digital technology. It is described as society of globalisation, diversity and pluralism of ideas, knowledge and brands. In its content and meaning, it is considered as paradoxical and contradictory. Digital technology development influences the conditions of work and everyday life for firms and individuals. It provides possibilities for new identities, perspectives and experiences for many people.

## References

- Bartels, R. (1970). *Marketing theory and metatheory*. Chicago: Irwin.
- DeNora, T. (2001). *Aesthetic agency and musical practice: new directions in the sociology of music and emotions*. In P. N. Juslin and J. A. Sloboda (Ed.), *Music and emotion: theory and research*. Oxford: Oxford University Press.
- Hultén, B. (2017). Branding by the five senses: A sensory branding framework. *Journal of Brand Strategy*, 6(3), 1-12. Retrieved from [researchgate.net/publication/322593642](https://researchgate.net/publication/322593642)
- Hultén, B. (2015). *Sensory Marketing. Theoretical and Empirical Grounds*. New York: Routledge.
- Hultén B., Broweus N., & van Dijk M. (2009). *Sensory Marketing*. London: Palgrave.
- Krishna, A. (2012). An Integrative Review of Sensory Marketing: Engaging the Senses to Affect Perception, Judgment and Behavior. *Journal of Consumer Psychology*, 22(3), 332-351. doi: 10.1016/j.jcps.2011.08.003
- Krishna, A. (2010). *Sensory Marketing: Research on the sensuality of products*. New York: Routledge.
- Siegel, R. E. (1970). *Galen on Sense Perception. His doctrines, observations and experiments on vision, hearing, smell, taste, touch and pain, and their historical sources*. New York: Karger.

## Contact information

### Ing. Tomáš Rebič

Slovak University of Agriculture  
Tr. Andreja Hlinku 609/2, 94976, Nitra, Slovakia  
E-mail: [futbalnitra@centrum.sk](mailto:futbalnitra@centrum.sk)  
ORCID: 0000-0001-5328-0745

### Dr.h.c. prof. Dr. Ing. Elena Horská

Slovak University of Agriculture  
Tr. Andreja Hlinku 609/2, 94976, Nitra, Slovakia  
E-mail: [elena.horska@uniag.sk](mailto:elena.horska@uniag.sk)  
ORCID: 0000-0002-4973-9573

doi: 10.7441/dokbat.2019.088

# THE CURRENT TREND IN THE INDUSTRY - INDUSTRY 4.0 IN SLOVAK ENTERPRISES

*Patrik Richnák*

## **Abstract**

The onset of digitalization in all business areas started to show major changes. New global markets, business models, advances in information and communication technologies and innovation are arising in each business area. Currently, Industry 4.0 dominates the world. It brings not only revolutionary changes in production and logistics, but fundamentally changes the society itself and the economy of the country. Industry 4.0 is based on the idea of linking digitization and automation using the latest technology. The basis is the Internet of Things and Services, smart devices that communicate with each other through cyber-physical systems and are independent of people. The main aim of this paper was based on theory and research in Slovak enterprises to evaluate the position and usage of Industry 4.0. We used classical methods: literary research, analysis, synthesis, induction, deduction and comparison. We also used graphical methods and descriptive statistics. In this paper, we analyse the position of Industry 4.0 in the world based on foreign surveys and in Slovakia based on our own survey. Industry 4.0 revolution is becoming more and more known, making it the most important factor in the development of the industry of each state. Industry 4.0 represents major changes in industry and society as a whole. The paper expands awareness of Industry 4.0 in conditions of Slovak enterprises. The Fourth Industrial Revolution significantly changes the direction of enterprises. Slovakia, which lags behind the implementation of Industry 4.0, is not an exception, but enterprises are aware of the importance of this phenomenon of digitalization.

*Keywords: industry 4.0, digitalization, smart industry, smart manufacturing*

## **1 INTRODUCTION**

At the threshold of the 21st century, enterprises are in an environment of fierce competition, widespread globalization and the dynamic growth of new technologies, approaches and concepts. With these changes, there is a new understanding of the enterprise, because the position of man in the process of value creation comes to the fore.

In the current highly globalized environment, it is imperative that businesses deal with the quality of products and services provided, as competition is not only for the domestic market but also for the world market. This is the reason why the company seeks to create a competitive advantage over other producers and service providers (Klátiková & Gubová, 2015). International integration, which intensifies international competition, also influences globalisation of the world and the scientific and technological progress in the field of communications (Bolek, 2016).

The onset of digitization in all business areas started to show major changes. New global markets, business models, advances in information and communication technologies and innovation in every business area are emerging. Digital transformation in conjunction with the dynamic development of society, however, goes even further. New technologies fundamentally change the way businesses operate and develop their business, bringing new challenges to IT managers. How successfully the company will adapt to the digital transformation will be directly related to its competitiveness and future market survival (Čambalíková, 2015).

## 2 LITERATURE REVIEW

Industry 4.0 represents technological changes in production. At the same time, it also prepares priorities for a coherent policy framework with a view to ensuring the international competitiveness of industry (Schröder, 2016). Bledowski (2015) and Rojko (2017) say that Industry 4.0 is a strategic initiative of the German government that traditionally heavily supports development of the industrial sector. The beginnings of Industry 4.0 can be found in the German Government's 2006 strategy, named High Tech Strategy, with some of the features of Industry 4.0 being defined in the German Industry Plan in 2010. Koch et al. (2014) and Yang et al. (2018) define Industry 4.0 as the Internet of Things, a ubiquitous connection of machines, products, systems and people. The aim is to achieve a high level of automation in the manufacturing industry through the adoption of ubiquitous information and communication technologies (ICTs).

Kaggerman, Wahlster & Helbig (2013) advocate that Industry 4.0 is focused on Smart Process, where employees, resources and machines not only communicate but also work together. The machines themselves report to the employee a problem that they have defined. The product, along with the RFID chip, controls its flow through production, knowing which parts it is composed of and where it is to be delivered, involved in the manufacturing process. Connections such as Smart Logistics, Smart Distribution, Smart Buildings and Smart Grid are in the infrastructure of this enterprise.

Hermann, Pentek, & Otto (2016), Lu (2017) and Atik & Ünlü (2019) claim that Industry 4.0 represents the automation technologies in the manufacturing industry, and it mainly includes enabling technologies such as the cyber-physical systems (CPS), Internet of Things (IoT) and cloud computing. Industry 4.0 aims to improve and modernize existing production facilities by using key technologies such as IoT, Internet of Services (IoS), CPSs, autonomous, flexible and cooperative robotics, simulations that leverage real-time data and mirror real world into a virtual model, big data analytics, augmented reality (AR), additive manufacturing, information and communication technologies (ICTs), digital twin, RFID (Radio Frequency Identification), RTLS systems (Real Time Location System), collaborative robots, cloud computing (Lasi et al., 2014; Lee & Lee, 2015; Pereira & Romero, 2017; Zhong et al., 2017; Yáñez, 2017).

Industry 4.0 builds on FoF (Factory of the Future), which was created by the evolution of CIM (Computer Integrated Manufacturing). Industry 4.0 consists of six basic principles (Obitko & Jirkovský, 2015): interoperability - the ability of cyber-physical systems, people and all components of intelligent manufacturing companies to communicate with each other via the Internet of Things and Internet of Services; visualization - the ability to link physical systems to virtual models and simulation tools; decentralization - decision-making and management is carried out autonomously and in parallel in individual subsystems; ability to work in real time - to meet the real-time requirement is a key condition for any communication, decision-making and managed in real-world systems; service orientation - preference of the computational philosophy of offering and using standard services, leads to Service Oriented Architectures (SOA), modularity and reconfigurability - Industry 4.0 systems should be maximally modular and capable of autonomous reconfiguration based on automatic situation detection.

Industry 4.0 emphasizes the increasing digitization of the entire supply chain, which makes it possible to connect actors, objects and systems based on real-time data exchange (Dorst et al., 2015; Spath et al., 2013). Rathouský, Jirásek and Staněk (2016) consider the use of the Cyber Physical System (CPS) as the latest trend of competitive advantage that enables the logistics chain to reach the customer through full individualization of products and services. The individual configuration within Business to Business and Business to Customers stores is made possible by a combination of the logistic concept of postponement and the integration of modern

ICT and Big data elements, simulation, automation and additive manufacturing. The result is customer satisfaction in a short time with a fully automated product. The authors argue that any uniqueness is imitated by other competitors, creating an endless struggle, which holds true in the form of Industry 4.0.

Nenadál et al. (2018) consider the core task of the Industry 4.0 concept to combine individual innovation activities throughout the entire chain from production through distribution to consumption and thus contribute to the further development of the organization. Industry 4.0 relies on communication and information technologies, including the possibility of processing and storing big data, cyber or robotic means, new materials and technologies, and education including retraining with an emphasis on the emergence and support of new fields of study for new labour market needs. This view is shared by Bal & Erkan (2019). The basic elements of Industry 4.0 include: (a) **Cyber-physical systems** - consist of physical entities controlled by computer algorithms. The basis is the cooperation of independent control units, which are able to autonomously decide, manage the entrusted technological unit and become an independent and full member of complex production units. (b) **Internet of Things** - a system in which various objects can be remotely controlled and integrated with each other. This is done through chips, sensors and software. (c) **Internet services** - a system that is based on online work and data sharing in cloud storage. Cloudy is a tool for cooperative content creation. Another advantage is high connectivity; any web browser can use them. In addition, there is no need to store data on your own hard drive and purchase and install software. (d) **Digital economy** - a concept that allows some activities from everyday life to be transferred to the Internet to reduce costs and increase comfort

Jurová et al. (2016) points out that under Industry 4.0, the term digital factory is transformed into an intelligent factory, which is built on high adaptability, resource efficiency, ergonomic layout and integrating customers and business partners into the business.

Magruk (2016) understands Industry 4.0 as an industrial revolution that digitizes material production with support for CPS systems in the Internet of Things (IoT) environment, which also uses Internet Services (IoS) and Internet Media or also called Internet of People (IoP). Production will be subject to customization, which means that it will reflect the specific requirements of customers who will also become part of the production.

Rakyta & Fusko (2018) characterize Industry 4.0 as a fully automated production that manages all processes that are carried out in real time to changing external conditions. Cyber-physical systems create virtual copies of physical world objects, control physical processes and make decentralized decisions. They can also integrate into one network, communicate in real time, adapt and learn. Internet technologies, which ensure communication between employees and machines, are an essential part. Enterprises produce products according to the requirements of individual customers.

### 3 METHODOLOGY

The main aim of this paper was based on theory and research in the Slovak enterprises to evaluate the position and usage of Industry 4.0. To provide a coherent view, it was necessary to define terms and concepts related to the fourth industrial revolution, which is characterized by Industry 4. Subsequently, we focused on the identification of Industry 4.0 in the world. In the next part of the paper, we described the position of Industry 4.0 in Slovakia. We obtained a real picture of the current situation through research conducted in Slovak companies. We used classical methods: literary research, analysis, synthesis, induction, deduction and comparison. We also used graphical methods and descriptive statistics.

The object of the research, which was carried out by a questionnaire survey, were small, medium-sized and large enterprises operating in the Slovak Republic. The categorization of enterprises by size was based on the EU Commission Regulation no. 651/2014, where we considered as a small enterprise with a number of employees up to 50 and annual turnover up to 10 million euro. As a medium-sized enterprise, we considered the company with a number of employees up to 250 and an annual turnover of up to 50 million euro. As large enterprise, we considered the company with more than 250 employees and annual turnover of more than 50 million euro. Research has involved 150 Slovak enterprises. The respondents were logistics managers. Data collection took place over a period of six months.

## 4 RESULTS

### 4.1 The position of Industry 4.0 in the world

Roland Berger Strategy Consultants (Blanchet et. al, 2014) have evaluated the manufacturing industry in the European Union and has developed a country plan for Industry 4.0. European countries divided into four main groups: (1) **The Frontrunners** are characterized by a large industrial base and very modern business conditions and technologies. There are countries like Sweden, Austria, Germany and Switzerland. Ireland is a specific case because large pharmaceutical companies generate high GDP compared to other businesses. Ireland also has a large IT service sector. (2) **The Traditionalists** are mainly in Eastern Europe. They are still pushing to grow on their stable industrial base, but few have so far put forward an initiative to turn the industry into a new era. We include the countries of the Slovak Republic, the Czech Republic, Hungary, Slovenia and Lithuania. (3) **The Hesitators** are the countries of southern and eastern Europe where there is a lack of a reliable industrial base. Many face serious fiscal problems. These include Italy, Spain, Poland, Portugal, Estonia, Croatia and Latvia. (4) **The Potentialists** are an interesting grouping. Their industrial base has been weakened in recent years, but they have the knowledge and the thinking that allows them to quickly implement Industry 4.0. This includes Norway, Great Britain, France, Denmark, Netherlands and Belgium.

PricewaterhouseCoopers has conducted a Global Industry 4.0 Survey with more than 2,000 respondents from 9 major industrial sectors and 26 countries around the world. According to the survey, by 2020, up to US \$ 907 billion will be invested in modern digital technologies each year. For respondents, this represents an average of around 5% of annual revenues. Up to 55% of respondents expect return on investment during the first two years. Digital technologies enable shorter operational lead times, higher asset utilization and maximize product quality. Respondents expect to save US \$ 421 billion in costs each year for the next five years. An increase in annual revenues of US \$ 493 billion is also expected over the next five years in the industrial sectors we surveyed (Rumpfenhorst, 2016).

Boston Consulting Group summarized the benefits and financially quantified the benefits of Industry 4.0 to Germany as the first country to implement this strategy. The first advantage is productivity, which should be increased by 15-25%. The second benefit is an increase in revenue estimated at 30 billion euro. The third is employment, where employment is expected to increase by 6% over the next 10 years. A fourth advantage of the investments that are in the next 10 years estimated at 250 billion euro (Rüßmann et al., 2015).

### 4.2 The position of Industry 4.0 in Slovakia

The World Economic Forum, in collaboration with the consultancy A. T. Kearney, has produced a study Readiness form the Future of Production 2018. According to the study, there are only 25 countries in the world that are able to benefit from the changes in manufacturing

systems related to the advent of Industry 4.0. Slovakia is not there, but the Czech Republic belongs there. When assessing preparedness, Slovakia was included in a group of traditional countries characterized by a strong current industrial base but a risky future. Among the strengths of a country is the production structure, which measures the extent and complexity of the country's production. Demand, technology and innovation are among the weakest category in Slovakia. In the field of demand, Slovakia falls in the sophistication of investment in new technologies (Kvašňák, 2018).

An extensive project of automation and digitization of production is under way in Flatline plant in Malacky. The automation concept was created directly in Malacky by the domestic investment team. They used their own know-how and experience from other IKEA plants. The production processes are already fully automated, now they want to robotize the packaging to achieve their goal, an intelligent factory where the first hand that touches the product is the customer's hand. The packaging process is digitized but parts are still handled manually. For example, if twenty products need to be placed in a package, twenty workers must stand at the packaging line. They want to automate this monotonous process. The robot should handle one cycle of packaging within six seconds. They are currently preparing a pilot project which, if successful, will be practically fully automated (Jurina, 2018).

### 4.3 Research in the Slovak enterprises

The survey was carried out in 150 Slovak enterprises. Of the research sample, 22.7% of enterprises in the Trnava Region were the most involved. The lowest percentage (5.3%) achieved the Košice Region. Of the total number of respondents who participated in the survey, the largest number achieved medium-sized enterprises with a share of 46%. The largest share was represented by manufacturing enterprises with a percentage of 77.3%. The largest part of the research sample belongs automotive industry with a share of 20.7%. Of the total number of respondents, glass industry recorded for the least proportion (1.3%).

Other questions concern the evaluation of the application of Industry 4.0 in the Slovak enterprises. Figure 1 shows the percentage usage of Industry 4.0. We can see from the figure that they do not usage of Industry 4.0 in the Slovak enterprises. Of the total number of respondents, Industry 4.0 uses only 13%. Industry 4.0 is not used by up to 87% of the Slovak enterprises.

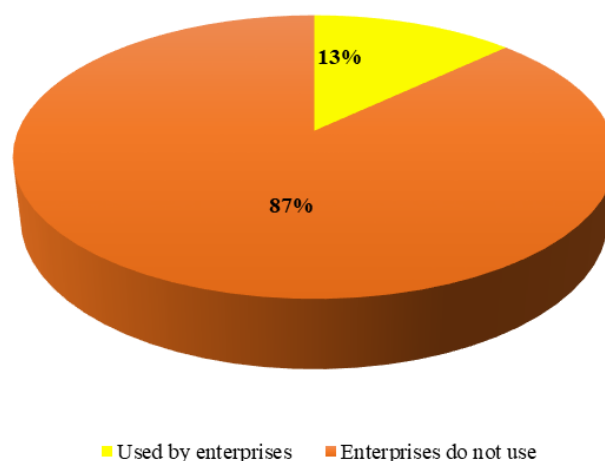

Fig. 1 – Usage of Industry 4.0 in the Slovak enterprises. Source: own research

Table 1 shows descriptive statistics on the use of Industry 4.0 in the Slovak enterprises. The mode and median achieved 0. The mean value of Industry 4.0 achieved 1.01. Standard deviation achieved 1.539.



Tab. 1 – Descriptive statistics. Source: own research

	N		Mean	Median	Mode	Std. Deviation
	Valid	Missing				
Industry 4.0	150	0	1.01	.00	0	1.539

Industry 4.0 is mainly used by large enterprises with a percentage of 58.3%. Medium-sized enterprises use Industry 4.0 with a share of 35.1%. Small enterprises have the smallest percentage of the use of Industry 4.0. The percentages are shown in Figure 2.

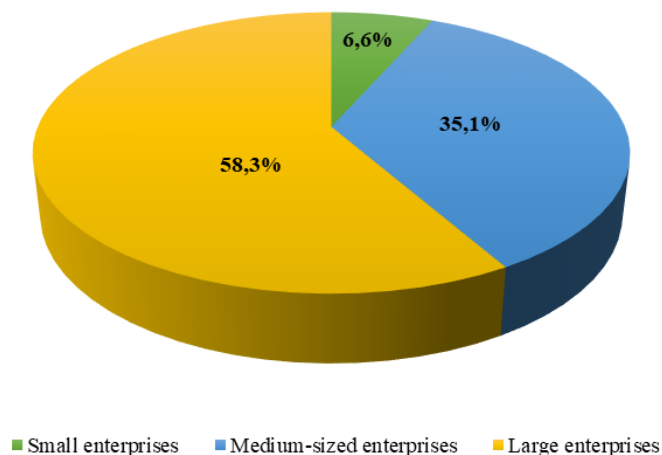

Fig. 2 – Usage of Industry 4.0 in enterprises by business size. Source: own research

Figure 3 shows the percentage usage of Industry 4.0 in business logistics of the Slovak enterprises. The enterprises usage most of Industry 4.0 in production logistics. Percentage achieved value 54%. Industry 4.0 is used by enterprises in procurement logistics with a share of 26.4%. Industry 4.0 is used in distribution logistics with a share of 20.6%.

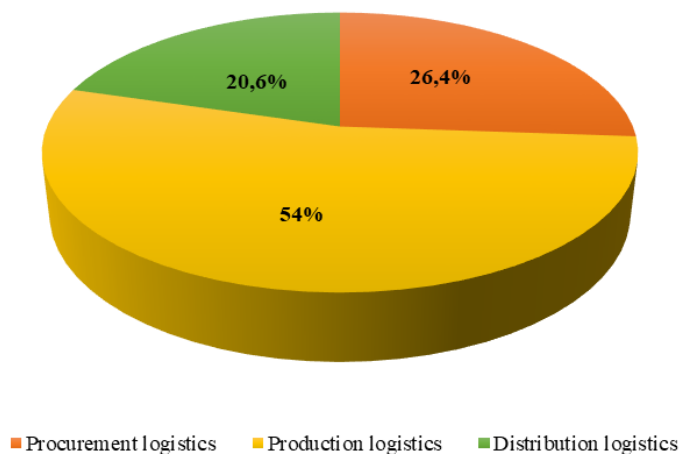

Fig. 3 – Usage of Industry 4.0 of business logistics fields. Source: own research

Figure 4 shows the use of Industry 4.0 in different types of industry in Slovakia. The radar graph was created based on the mean values. Industry 4.0 is the most widely used in electrical engineering industry (2.2). Industry 4.0 also recorded a high mean usage in logistics and transport (1.36), engineering industry (1.21) and automotive industry (1.03). Industry 4.0 in Slovak enterprises does not use wood processing industry, chemical industry, glass industry and textile industry.

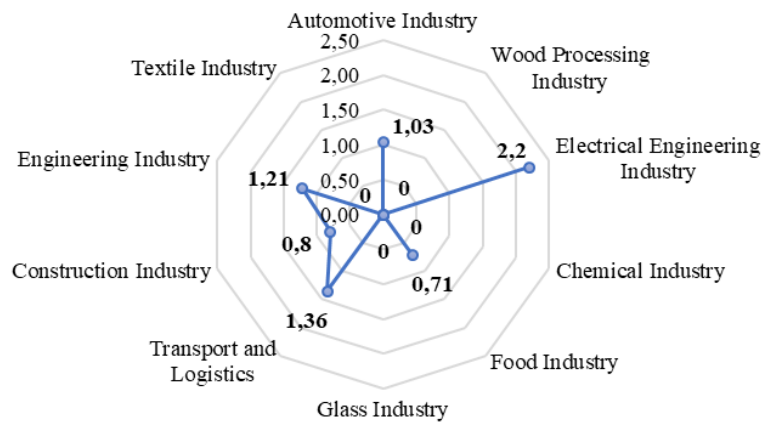

Fig. 4 – Usage of Industry 4.0 in enterprises by types of business industries. Source: own research

Figure 5 shows the use of Industry 4.0 in regions in Slovakia. The radar graph was created based on the mean values. Industry 4.0 is mostly used in enterprises in the Bratislava Region. The mean value achieved 1.77. Industry 4.0 also recorded a high mean usage in enterprises of the Prešov Region (1.08), Žilina Region (1.07), Banská Bystrica Region (1). The lowest mean values were recorded in Trenčín Region (0.56) and Košice Region (0.25).

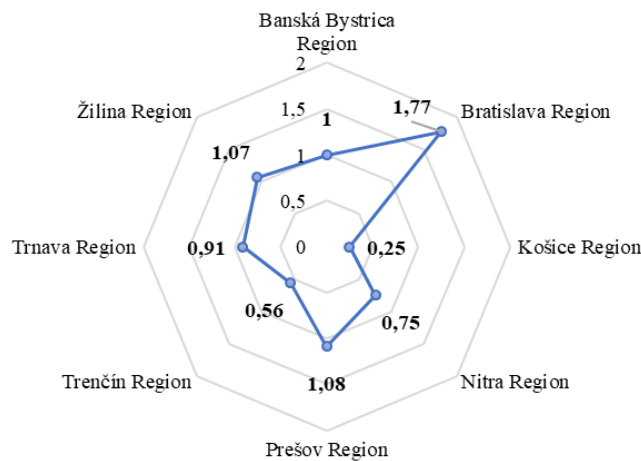

Fig. 5 – Usage of Industry 4.0 in enterprises by regions of Slovakia. Source: own research

## 5 CONCLUSION

The Fourth Industrial Revolution brought together the physical, cyber and socio-economic world. Combining these three worlds creates a revolutionary approach in enterprise. Industry 4.0 offers manufacturers the opportunity to optimize their processes to improve productivity and meet personalized customer requirements.

Based on the results of the research, we are of the opinion that Slovakia does not use Industry 4.0 to a large extent. Industry 4.0 is used only by 13% of the enterprises surveyed. Industry 4.0 is mainly implemented by large enterprises. Their percentage achieved up to 58.3%. We believe that even small and medium-sized enterprises in Slovakia will have to accept and implement Industry 4.0. This will be a prerequisite for business development and international cooperation. Industry 4.0 also plays an important role in business areas and processes. Industry 4.0 is mainly used in production logistics. Percentage achieved value 54%. Industry 4.0 is the most widely used in electrical engineering industry. Industry 4.0 is mostly used in enterprises in the Bratislava Region. Every enterprise must realize that in addition to shortening the product

innovation cycle, shortening delivery times, and minimizing costs, it is possible to maintain an excellent level of supplier-customer relationships thanks to a new phenomenon Industry 4.0.

Industry 4.0 is gradually evolving and represents a great potential for the Slovak industry. Its slow implementation in Slovakia and the low percentage of use justify that there is no state concept in Slovakia dealing with Industry 4.0. Abroad, there are plans and strategies that comprehensively involve the digitalization of industry. Roland Berger Strategy Consultants ranked Slovakia as a traditionalist. This is also the reason why Slovakia remains in implementing and using Industry 4.0. There are enterprises in Slovakia that make full use of Industry 4.0. In the paper, we have given an example of using Industry 4.0 in the Slovak enterprise.

Industry 4.0 revolution is becoming more and more known, making it the most important factor in the development of the industry of each state. Its technologies are a modern trend not only in industry but also in other areas of the economy and are pushing the economy and business forward. The aim of the paper was to describe Industry 4.0 based on a literature review and identify its development and position in the world and in Slovakia.

### **Acknowledgments**

This contribution is a partial output of the Project of Young Teachers, Researchers and Full-time PhD. Students at University of Economics in Bratislava, No. I-19-104-00 New dimension of logistics in the Fourth Industrial Revolution in Slovak enterprises.

### **References**

- Atik, H., & Ünlü, F. (2019). The Measurement of Industry 4.0 Performance through Industry 4.0 Index: An Empirical Investigation for Turkey and European Countries. *Procedia Computer Science*, 158, 852-860. doi: 10.1016/j.procs.2019.09.123
- Bal, H. Ç., & Erkan, Ç. (2019). Industry 4.0 and Competitiveness. *Procedia Computer Science*, 158, 625-631. doi: 10.1016/j.procs.2019.09.096
- Blanchet, M., Rinn, T., Georges de Thieulloy, & Georg von Thaden. (2014). *THINK ACT Industry 4.0 The new industrial revolution - How Europe will succeed*. Retrieved from [https://www.rolandberger.com/publications/publication\\_pdf/roland\\_berger\\_tab\\_industry\\_4\\_0\\_20140403.pdf](https://www.rolandberger.com/publications/publication_pdf/roland_berger_tab_industry_4_0_20140403.pdf)
- Bledowski, K. (2015). *The Internet of Things: Industrie 4.0 vs. the Industrial Internet*. Retrieved from [https://static1.squarespace.com/static/58862301f7e0ab813935c244/t/58c7e6e99f7456127b563480/1489495785148/PA-161\\_0+%281%29.pdf](https://static1.squarespace.com/static/58862301f7e0ab813935c244/t/58c7e6e99f7456127b563480/1489495785148/PA-161_0+%281%29.pdf)
- Bolek, V. (2016). *Information literacy models in managerial education*. Praha: Wolters.
- Čambalíková, A. (2015). Využitie manažérskych nástrojov Big Data Analytics a Digital Transformation. In M. Beňová, V. Bolek & F. Korček (Eds.), *Manažment informačnej bezpečnosti v malých a stredných podnikoch*. Bratislava: Ekonóm.
- Dorst, W., Glohr, C., Hahn, T., Knafla, F., Loewen, U., Rosen, R., Schiemann, T., Vollmar, F., & Winterhalter, C. (2015). *Umsetzungsstrategie Industrie 4.0. Ergebnisbericht der Plattform Industrie 4.0*. Frankfurt am Main: Bitkom.

- Hermann, M., Pentek, T., & Otto, B. (2016). *Design Principles for Industrie 4.0 Scenarios*. Paper presented at the 49th Hawaii International Conference on System Sciences, Koloa, Hawaii. Koloa: IEEE. doi: 10.1109/hicss.2016.488
- Jurina, L. (2018). *IKEA postavila inteligentnú fabriku*. Retrieved from <https://www.etrend.sk/firmy/ikea-stavia-plne-automaticku-fabriku.html>
- Jurová, M. et al. (2016). *Výrobní a logistické procesy v podnikání*. Praha: Grada.
- Kaggerman, H., Wahlster, W., & Helbig, J. (2013). *Recommendations for implementing the strategic initiative Industrie 4.0*. Retrieved from [http://www.plattform-i40.de/sites/default/files/Report\\_Industrie%204.0\\_engl\\_1.pdf](http://www.plattform-i40.de/sites/default/files/Report_Industrie%204.0_engl_1.pdf)
- Klátiková, D. & Gubová, K. (2015). Kvalita elektronickej služby ako faktor zabezpečenia konkurencieschopnosti podniku. *Manažment podnikania a vecí verejných - Dialógy*, 10(30), 97-107.
- Koch, V., Kuge, S., Geissbauer, R., & Schrauf, S. (2014). *Industry 4.0: Opportunities and challenges of the industrial internet*. Retrieved from <https://www.pwc.nl/en/assets/documents/pwc-industrie-4-0.pdf>
- Lasi, H., Fettke, P., Kemper, H. G., Feld, T., & Hoffmann, M. (2014). Industry 4.0. *Business & Information Systems Engineering*, 6(4), 239-242. doi: 10.1007/s12599-014-0334-4
- Lee, I., & Lee, K. (2015). The Internet of Things (IoT): Applications, investments, and challenges for enterprises. *Business Horizons*, 58(4), 431-440. doi: 10.1016/j.bushor.2015.03.008
- Lu, Y. (2017). Industry 4.0: A survey on technologies, applications and open research issues. *Journal of Industrial Information Integration*, 6, 1-10. doi: 10.1016/j.jii.2017.04.005
- Magruk, A. (2016). Uncertainty in the Sphere of the Industry 4.0 - Potential Areas to Research. *Business, Management and Education*, 14(2), 275-291. doi: 10.3846/bme.2016.332
- Nenadál, J. et al. (2018). *Management kvality pro 21. století*. Praha: Management Press.
- Obitko, M., & Jirkovský, V. (2015). Big Data Semantics in Industry 4.0. In V. Mařík, A. Schirrmann, D. Trentesaux & P. Vrba (Eds.), *Industrial Applications of Holonic and Multi-Agent Systems*. Cham: Springer. doi: 10.1007/978-3-319-22867-9\_19
- Pereira, A. C., & Romero, F. (2017). A review of the meanings and the implications of the Industry 4.0 concept. *Procedia Manufacturing*, 13, 1206-1214. doi: 10.1016/j.promfg.2017.09.032
- Rakyta, M., & Fusko, M. (2018). *Prevádzka a údržba strojov*. Žilina: Žilinská univerzita.
- Rathouský, B., Jirsák, P., & Staněk, M. (2016). *Strategie a zdroje SCM*. Praha: C. H. Beck.
- Rojko, A. (2017). Industry 4.0 Concept: Background and Overview. *International Journal of Interactive Mobile Technologies*, 11(5), 77-90. doi: 10.3991/ijim.v11i5.7072
- Rumpfenhorst, F. (2016). *Industry 4.0 building your digital enterprise*. Retrieved from <https://www.pwc.com/gx/en/industries/industries-4.0/landing-page/industry-4.0-building-your-digital-enterprise-april-2016.pdf>
- Rüßmann, M., Lorenz, M., Gerbert, P., Waldner, M., Justus, J., Engel, P., & Harnisch, M. (2015). *Industry 4.0: The Future of Productivity and Growth in Manufacturing*. Retrieved from <http://www.zvw.de/media/media.72e472fb-1698-4a15-8858-344351c8902f.original.pdf>

- Schröder, C. (2016). *The Challenges of Industry 4.0 for Small and Medium-sized Enterprises*. Bonn: Friedrich-Ebert-Stiftung.
- Spath, D., Ganschar, O., Gerlach, S., Hämmerle, M., Krause, T., & Schlund, S. (2013). *Produktionsarbeit der Zukunft-Industrie 4.0*. Stuttgart: Fraunhofer Verlag.
- Kvašňák, L. (2018). *Kto ťahá za nitky inteligentného priemyslu na Slovensku*. Retrieved from <https://www.etrend.sk/trend-archiv/rok-2018/cislo-9/kto-taha-za-nitky-inteligentneho-priemyslu-na-slovensku.html>
- Yang, S., Aravind Raghavendra, M. R., Kaminski, J., & Pepin, H. (2018). Opportunities for Industry 4.0 to Support Remanufacturing. *Applied Sciences*, 8(7), article 1177. doi: 10.3390/app8071177
- Yáñez, F. (2017). *The 20 Key Technologies of Industry 4.0 and Smart Factories: The Road to the Digital Factory of the Future*. Independently Published.
- Zhong, R. Y., Xu, X., Klotz, E., & Newman, S. T. (2017). Intelligent Manufacturing in the Context of Industry 4.0: A Review. *Engineering*, 3(5), 616-630. doi: 10.1016/j.eng.2017.05.015

### Contact information

#### **Ing. Patrik Richnák, PhD.**

University of Economics in Bratislava, Faculty of Business Management  
Dolnozemska cesta 1/b, 85235, Bratislava, Slovak Republic  
E-mail: patrik.richnak@euba.sk  
ORCID: 0000-0002-9694-7658

doi: 10.7441/dokbat.2019.089

# CIVIC PARTICIPATION AND MUNICIPAL ELECTIONS IN MUNICIPALITIES OF TRNAVA REGION

*León Richvalský*

## **Abstract**

This paper deals with the issue of civic participation at the local level. We analyse participation rate in four municipalities of the Trnava region, in the towns of Piešťany and Hlohovec and in the villages of Dechtice and Krakovany. We analysed civic participation as a social phenomenon in the past and present, as well as on the level of definition in scientific literature. In the practical part we focused on measuring and characterizing the development of this phenomenon. The main indicator in our paper is electoral participation in the selected municipalities in municipal elections organized within the territory of the Slovak Republic. We conducted interviews with representatives of the selected towns and villages, with mayors or persons designated by them, in which we examined their views on civic participation and citizens' interest in self-government. The obtained results were compared with each other and with the national level. In the municipalities we examined, civic participation is sufficiently widespread, and in some cases voter turnout even exceeds the national averages.

*Keywords: self-government, municipality, town, citizen, mayor, participation, elections*

## **1 INTRODUCTION**

Citizenship as an institute is currently facing diametrically different conditions than in the past. The concepts of citizenship, as we know them from ancient Greece or Rome, were the initial impulse in the development of democracy, but they are difficult to apply to the contemporary world. Višňovský (2010) considers the „Citizenship and Social Class: And Other Essays“ by Thomas Humphrey Marshall to be a ground-breaking work in defining citizens and citizenship in the modern world. Marshall divided the citizenship to three areas. The area of civil rights concerns the personal freedoms which the state ensures by the judicial power. The area of political rights covers the possibility of civic participation ensured by legislation and the constitution. The area of social rights provides the citizen with a minimum standard of living, which is achieved by state through its educational and economic systems. Marshall's work was significant not only for the concept presented by the author, but also for the professional discussion which was subsequently provoked. Thanks to this debate and criticism, citizenship has moved to the next level where it became being perceived as a broader phenomenon, not just political or legislative. The citizen raised from the level of the recipient of state power to the level of the partner in its creation. Višňovský (2010) confirms this development and emphasizes that the citizen's commitment to participation in state power creation is only potential. On the base of respecting human rights and freedoms, the state does not force citizen's activities, thus giving him room for voluntary passivity (Višňovský, 2010). Pirošík (2005) expresses a clear opinion on this issue and considers civic passivity to be harmful. Indeed, experiences from both the domestic and foreign environment shows that civil society, together with democracy, does not develop until citizens engage in public affairs. In some cases, these institutions fail totally due to civic passivity (Pirošík, 2005).

From this point of view, post-communist states are often problematic, (which is the case of Slovak Republic), but also countries that had little experience with the democratic form of government. In totalitarian regimes, criticism of the political elite is undesirable and directly

unacceptable; citizens must either submit or face repression. Thus, before 1989, civil society in the form of a politically critical public, an association of citizens expressing opposing ideas, or in the form of platforms defining social problems and creating pressure on the government could not exist in Slovakia. Moreover, this situation was not short-lived, but continual for more than 40 years. Citizens continued to lose their interest in politics, in monitoring the development of political and civic issues, which was compounded by fear of spreading opposing ideas. Nonetheless, civil society at levels other than political was also present during this period, and citizen associations were possible despite the limited freedom.

At a level that was illegal at this time, there was an activity of opponents of the regime known as dissent, which culminated in the late 1980s and led to massive civil mobilization and the fall of the totalitarian regime in 1989. As a result of this civil victory over state power, citizens' interest in participation has increased in the coming years, and the first years of democratic elections showed high percentages of voter turnout (Horváth & Machyniak, 2018). However, participation was not maintained at this level and voter turnout began to decline in the coming years.

## **2 METHODOLOGY**

We found out how citizens fulfil their obligations, but also how they use their rights by asking directly in selected municipalities - towns of Piešťany and Hlohovec and villages of Dechtice and Krakovany. We conducted interviews with representatives of selected municipalities, mayors, or persons designated by them, in which we examined their views on the level of civic participation and citizens' interest in self-government. We also measured participation by the use of analytical method, focusing on statistical data of electoral turnout of the selected municipalities in municipal elections.

We have focused on these municipalities for several reasons. Historically, all the above-mentioned municipalities belonged to the Trnava district, for example also according to the territorial breakdown of the Slovak Republic from 1990 to 1996. The Trnava district at that time was basically a composition of the present districts of Piešťany, Hlohovec and Trnava. These three districts are culturally and economically close, so the comparison of civic participation will not be disrupted by other influences. If the comparison was carried out within the whole Trnava Region as we know it at present, differences in nationality and culture might influence the voter turnout in some parts.

In our comparison, we wanted to examine smaller towns and villages where it is relatively easy to participate on a personal level, by visiting municipal offices and mayors. This was important for our interviews, because we wanted to talk to mayor or person managing participation which became much more difficult in larger municipalities. For example in the town of Trnava with 65 207 inhabitants, participation and contact with citizens is managed by multiple people and personal visits in mayor's office are much harder to arrange. Taking this into account during the selection of towns, we set the interval of population from 20 to 40 thousand, and in the case of villages from 1 to 2 thousand. This interval of population was set with intent to observe municipalities with significantly less inhabitants than selected towns, avoiding the smallest ones where the participation and voter turnout might be influenced by outside factors. Small villages are very common in Slovakia, currently there are 139 municipalities with less than 99 inhabitants. According to same statistic data, most Slovak municipalities (currently 2 454) are within the range under 2000 inhabitants (SUSK, 2019a). Within the districts of Piešťany, Hlohovec and Trnava, two municipalities met our conditions for town, so we included them both in our paper. There were several villages within set population range, so we have chosen two which responded to our interview request first and were geographically closest to us.

### 3 PARTICIPATION IN SELECTED MUNICIPALITIES

#### 3.1 Participation in Piešťany

The town of Piešťany is located in the north-eastern part of the Trnava self-governing region, has an area of 4 420 ha and as of 31 December 2018 it has 27 534 inhabitants. The town consists of two cadastral territories, Piešťany and Kocurice. In the years 1973-1995, however, cadastral territories were three. The third part was now an independent village Banka (Murín, 1996). Since 2014, mayor of Piešťany has been Miloš Tamajka and since May 2017 his vice-mayor was Martin Valo. Vice-mayor Martin Valo, who also gave his insight for our paper, co-founded the Public against Violence movement in 1989 and is a long-time member of the Piešťany municipal council. In the last elections in 2018, the post of mayor was taken by Peter Jančovič and Michal Bezák became his vice-mayor. At present, the town of Piešťany has 8 partner cities (Piešťany, 2019): Budapest and Hajdúnánás (Hungary), Heinola (Finland), Luhačovice and Poděbrady (Czech Republic), Ustroń (Poland), Varaždinske Toplice (Croatia) and Eilat (Israel).

**Communication with citizens:** The town of Piešťany provides citizens with several ways of communicating, and according to the former vice-mayor, citizens use all of them and their interest in participating can be described as sufficient. Citizens' complaints come in both direct and indirect form. Visits of municipal office, attendance at council meetings, phone calls or letters and emails are considered as direct form. Indirect forms are for example suggestions on social networks or through a form on the town website, which uses the portal "odkazprestarostu.sk". Citizens use each of these options to communicate, but in some cases the formal aspect fails. Although the town follows the law on access to information, the citizen cannot be replied if he does not provide his name or address. According the law, the municipality is not even obliged to respond to anonymous requests. Citizen communication, mostly suggestions for improvement and requests, are addressed to wrong people or are outside the competences of the municipality. The most common addressee is the mayor and his office, which ultimately extends the response time. By the time the request is forwarded to the right place, it may no longer be relevant and the citizen feels that he has been ignored. For example, notifications of polluted roads, damaged municipal property or dysfunctional public facilities which are reported anonymously via the contact form. Citizens are also visiting municipal office personally, but the meetings with the mayor or his vice-mayor are mostly complains about an issue that has already been addressed in some way, or effort to urge processes outside the competence of the municipality. At least one such personal visit takes place each day.

**Participation during municipal council meetings:** Citizens attend regular meetings of the municipal council, the former vice-mayor speaks of six citizens at each meeting in average. In the case of an important or interesting case, this number is also higher. However, the meetings often took place without the full participation of MP's who sometimes leave until the minimum number of MP's required for the legal conduct of the meeting remains.

**Petitions and civic associations:** In the area of petition activity we can talk about regular and numerous efforts, and four petitions per year are successful in average. In this case there is also a problem with respecting the formal aspect which is required by law on petitions. Thus, civic activity is regularly thwarted by the lack of preparation required by law. The last successful petition, which the former vice-mayor remembers, was a petition for stopping the construction of parking lot. There are currently about 150 registered civic associations (NGO's) within Piešťany, but only few are active. The largest are the sports clubs which are supported by the town with approximately € 280,000 per year. There are also youth and senior parliaments in Piešťany, but these organizations are not considered to be very relevant by the former vice-mayor because membership is voluntary, so it cannot be considered as a voice of public.



### 3.2 Participation in Hlohovec

The town of Hlohovec is situated in the central part of the Trnava Region, according to the latest data from December 31, 2018, it has 21 508 inhabitants and an area of 6 412 ha. Since 1953, Hlohovec also consists of two connected cadastral territories, local part Šulekovo and local part Peter (Hlohovec, 2019). Since May 2014, the mayor of Hlohovec is Miroslav Kollár. Information on civic participation was provided by Matúš Lukačovič, Strategy, Data and Participation Officer of the town of Hlohovec. Currently, the town of Hlohovec has three partner cities (Hlohovec, 2018): Slovenské Konjice (Slovak Republic), Hranice (Czech Republic) and De Panne (Belgium).

**Communication with citizens:** Town offers several ways for participation, using also a modern way via the Internet to address the younger generation. In addition to the participatory budget, the citizens of Hlohovec have the opportunity to participate in public space planning, which is offered by the website <http://hlohovec.ideasity.sk>. These opportunities also take place in a classical way, in a form of questionnaires or gatherings of citizens. Suggestions on the mentioned website are being rated by citizens, and those with the greatest support are supported by town as well. Citizens are offered the opportunity to participate in working groups to address specific issues, which has recently resulted in a new community plan for social services. On its website, town also offers a link to the well-known "odkazprestarostu.sk" which citizens mostly use to point out the pollution or damage to municipal property. The town of Hlohovec has created a separate page on the social network „Facebook“ focused on the issues of civic participation, where all current projects and offerings are published, and it also serves as another communication channel. Citizens also visit the municipal office personally, but the relevance of the visits varies, same as in Piešťany. Issues are often outside the competence of municipality, but these interviews are also useful to some extent, as a public opinion survey. The mayor has reserved the time to citizen visits, every Wednesday between 3 pm and 5 pm. On the first Wednesday of the month, these meetings take place in local part Šulekovo. Communication via letters, e-mail or telephone is not an exception, but sometimes it's addressed to wrong recipients, what extends the whole process.

**Participation during municipal council meetings:** The civic participation at the meetings of the municipal council is regular, the number depends on the current problems in the town. Meetings are recorded in both text and audio-visual form and are accessible on town website. As for the MPs themselves, we can talk about 75% attendance over the last year, so the council is always quorate.

**Petitions and civic associations:** There were no petitions at the time of interview with Mr. Lukačovič. The last petition he remembers was unsuccessful. Its object was to stop the construction of rental flats, as the misinformation that the flats would be provided to non-adaptable citizens free of charge was widespread. The most common issue which citizens report to the municipal office is the traffic situation. On the main road through the town, large traffic jams occur every day during rush hours, but the situation is in a solution phase in cooperation with the self-governing region. The second most common issue during the past year was the municipal flora, which is in the care of new company "Mestská zeleň Hlohovec, s.r.o." Town discussed those civic reports with company which improved their procedures and situation improved. There are several civic associations and municipal organizations in the town, most civic needs and interests are covered, so the formation of new civic associations was not registered at the time of our interview. The most active is the Voluntary Fire Brigade of Hlohovec, which focuses on fire protection and prevention, but also on educating youth and primary school pupils. Matúš Lukačovič, Strategy, Data and Participation Officer of Hlohovec, sees civic participation as appropriate. Citizens are involved through all provided

communication channels. The only problem is reduced voter turnout, but this is a problem at higher than municipal level.

### 3.3 Participation in Dechtice

Dechtice village is located at the border of central and northern part of the Trnava Region, according to the latest data from December 31, 2018, it has 1,842 inhabitants and an area of 1,946 ha. At present, Dechtice has one partner village Dolní Dunajovice (Czech Republic) (Dechtice, 2019). Since 2002 to the present, Karol Zachar is mayor for five consecutive terms of office, and he also provided his vast experience with civic participation in our interview, which he acquired during his 17-year practice.

**Communication with citizens:** In mayors words, citizens in the village regularly participate, the most used communication channel is telephone and personal contact. Most residents have a number of mayor's mobile phone, so in case of emergency he is reachable also after office hours. On average, six citizens make contact every month, and in most cases proposals are relevant, within the competence of municipality. For example, citizens initiated the construction of well-known grocery franchise in the village, because until then the sale had been carried out only by small private entrepreneurs, in their own small businesses. Citizens have also initiated flood protection, which helped in regularly flooded out areas. In most cases, however, there are just complains about damaged or dirty municipal property, sidewalks, roads, etc.

**Participation during municipal council meetings:** Meetings of municipal council are mostly attended by several citizens, as in previous municipalities, their number varies according to current problems. According to the mayor, duties are also fulfilled by the MPs; most of the meetings of the council are held with full attendance. At the time of our conversation, the municipality's land-use plan was just opened to incorporate changes to the third addendum, where citizens also participated. Based on the initiative of citizens from municipal council meetings, the historical Romanesque rotunda was reconstructed in 2016, with financial support from the European Union funds. It was this reconstruction that showed a lack of awareness about functioning of European resources. After the reconstruction started, citizens began to ask whether something else could be repaired with the money, something more important, or perhaps something new built in the village. Citizens had to be repeatedly explained that the funds were tied to a specific project and that nothing else could be financed with them.

**Petitions and civic associations:** In previous years, one effort to organise a local referendum appeared, on the subject to call of the mayor. This effort of one citizen did not meet the interest of other citizens, so the referendum was not organised due to insufficient number of signatures. The last petition mentioned by the mayor took place in 2017. Citizens expressed their disagreement with the dumping of waste to a nearby quarry, which is above the source of drinking water. Storing the waste above the source of drinking water is a serious problem according to Radovan Foltinský, CEO of Trnava Water Management Company. The dumped waste should meet certain conditions and consist only of soil, concrete, tiles or bricks. The Mining Office in Bratislava should immediately prevent the threatening of drinking water source which supplies almost 100,000 citizens (Trnavský hlas, 2017). 700 citizens expressed disagreement in petition, but the competent authorities did not respond and the re-cultivation of the quarry by dumping various materials continues. There are several local organizations active in the municipality, covering the interests of citizens in several areas and age categories. The mayor identified the local football team, the Unity of Pensioners of Slovakia, the Association of Gardeners, the local organisation of disabled and the Hunting Association as the most beneficial ones. At the time of our interview, local volunteer firefighters tried to set up a voluntary fire brigade. Long-term cooperation and mutual assistance is taking place with the civic association Katarínka. NGO Katarínka strives to save and repair the church and monastery

of St. Catherine of Alexandria, which is located in the forest in the village Dechtice (OZ Katarínka, 2001-2018). Volunteers from this association organize cleaning brigades, camps, events for children, and the municipality offers space and financial support in return. Youth and senior parliament does not exist in the village. The seniors discussed the creation of their parliament in the past, but eventually lost the interest. The mayor is satisfied with the level of civic participation in the municipality, in his words the involvement of citizens is appropriate and helpful.

### **3.4 Participation in Krakovany**

The village of Krakovany is located in the north - eastern part of the Trnava Region, according to data from December 31, 2018, it has 1,459 inhabitants and an area of 982 ha. It consists of two cadastral territories, Krakovany and Stráž, which merged in 1944 into one village (Krakovany, 2019). At present, the village of Krakovany has the same named partner village in the Czech Republic (Filo, 2016). The mayor of Krakovany is Fantišek Klinovský for the second election term, and he also gave us his view on civic participation.

**Communication with citizens:** When comparing civic participation with neighbouring municipalities, the mayor sees no significant negatives or positives. Citizens participate within all available forms, for example by telephone, e-mail, letter, but also by personal visits to the municipal office. There are no obstacles from the municipality side, and mayor has never noticed complaints about lack of space for citizens' voice. Initiatives are usually addressed directly to the mayor, but in villages it is not as delaying as in the case of larger cities. Five citizen interactions per month are usual. Often, however, these suggestions and complaints are outside the competence of municipality, at the level of civil disputes. There are regular complaints about a noisy disco, but since it does not disturb the nightly silent hours set by law, it can't be solved.

**Participation during municipal council meetings:** The municipal council meetings are usually without the participation of citizens, but in the time of problems in the municipality or upcoming events, citizens participate too. According to the mayor, the occasional problem in the form of reduced interest of MPs is present, but the meetings are not affected. Civil remarks are sometimes based on moderate rivalry between the cadastral areas of the village, Krakovany and Stráže. When planning or carrying out construction or reconstruction in one of these historical parts, citizens from the other part feel neglected and show it through comments. However, municipal property and communications must be addressed with regard to the necessity and usefulness for the benefits of whole village.

**Petitions and civic associations:** At present, the mayor does not register an ongoing petition, nor attempt to announce a local referendum. In this area mayor sees room for improvement, as the civic interest in the area of municipal management is reduced. The proof of this was the approval of economic plan of the municipality in 2015 entitled "Program of Economic and Social Development of the Krakovany Village for 2015-2025". In order to involve citizens, questionnaires were sent to all households, so residents had the opportunity to agree or comment on the plan. Subsequently, all residents were invited to a meeting of residents of the village, where they had the opportunity to discuss this document live. Only one citizen attended the meeting, which, on the other hand, can be explained as expressed consent and trust in the municipal council, but it was a surprising phenomenon.

Citizens were able to cooperate in the case of petition for the construction of a bike path that would connect the surrounding towns and villages, namely Piešťany, Trebatice, Krakovany and Vrbové. This bike path would be beneficial for citizens travelling to work within these municipalities, but also for children and young people to attend schools. However, the unused

railway route would have to be cancelled for the construction of the bike path. Only the historic train runs on the railway line, once a year. The second use is the lever trolley race, also only once a year. In this case, two opposing groups met, the Čango civic association, protecting the historic railway and the Green Road association of towns and villages, which is in favour of building the bike path. The Green Road Association organized the petition in 2017, and more than 3,500 signatures were collected. This situation has been solved for almost ten years, and both parties have presented reasonable arguments and expert opinions. In 2017, local governments and associations involved in these initiatives were also visited by Árpád Érsek, Minister of Transport, Construction and Regional Development (Palkovič, 2017). After ten years, however, we can finally talk about real plans for the construction of a bike path (Palkovič, 2018). The mayor of Krakovany described the civic interest in participation as average, however, in several cases he sees the possibility of improvement.

#### 4 MUNICIPAL ELECTIONS IN SELECTED MUNICIPALITIES

For the comparison we will use the results of elections to municipal self-government bodies (municipal elections), as our paper focuses on individual self-governing municipalities. At this electoral level, the voter turnout fell to lowest level of 47.65% in 2006, and stayed under 50% since.

Tab. 1 – Participation of citizens in municipal elections in the Slovak Republic. Source: SUSK (2019b)

Municipal election year	Participation (%)
1990	63.75
1994	52.42
1998	53.96
2002	49.51
2006	47.65
2010	49.69
2014	48.34
2018	48.67

Despite the fact that the voter turnout in the 1990 municipal elections was only 63.75%, it was historically the highest turnout at this electoral level. Since 2002, voter turnout has not exceeded 50%, which is a bad precondition for example for a local referendum, which requires attendance of majority of voters, over 50%. Unfortunately, detailed statistics of the 1990 municipal elections are unavailable, so it is not possible to compare voter turnout in individual municipalities in the first electoral year.

Tab. 2 – Participation of citizens in municipal elections in selected municipalities. Source: SUSK (2019b)

Municipal election year	Piešťany (%)	Hlohovec (%)	Dechtice (%)	Krakovany (%)
1994	39.49	38.43	64.28	73.43
1998	39.68	38.96	76.96	72.53
2002	34.89	35.80	75.34	70.10
2006	33.34	32.51	75.01	60.52
2010	35.39	39.81	69.62	58.07
2014	36.44	40.96	68.73	58.09
2018	37.12	43.37	67.10	45.19

## 5 DISCUSSION AND RESULTS

Comparing the 1994 turnout, which was nationwide at 52.42%, we see inconsistencies in all municipalities examined. In the case of the towns of Piešťany and Hlohovec, the turnout was significantly lower, approximately 13% below the Slovak average. On the contrary, the turnout was higher in the villages of Dechtice and Krakovany, in the case of the municipality of Krakovany by almost 20%.

The 1998 turnout, which was 53.96% nationwide, remained at similar levels in the selected municipalities as in the previous elections, with the exception of the village of Dechtice, where the turnout increased by more than 12% compared to 1994 elections.

The 2002 elections brought a more significant fall in voter turnout, to the 49.51% nationwide. The decrease can also be seen in the examined municipalities, where the turnout decreased by several percent compared to the previous year's elections. The largest decrease was recorded in the town of Piešťany, almost 5%, the smallest in the village of Dechtice, at the level of 1.5%.

The 2006 elections brought a historic decline in voter turnout. Within the monitored municipalities, this drop was most apparent in the village of Krakovany, where it dropped by approximately 10%. In other municipalities, the drop was moderate, at a maximum of 1%. In the case of the towns of Piešťany and Hlohovec, the turnout was historically at the lowest level, as well as on the nationwide level.

The year 2010 brought a nationwide increase in the turnout, approximately to the level of the 2002 elections. The town of Piešťany was closest to this development, where the comparison of the years 2002, 2006 and 2010 shows the same character of the decrease and increase in the turnout. In the case of the town of Hlohovec, the increase in 2010 was more pronounced and exceeded the 2002 turnout by 4%. In the villages of Dechtice and Krakovany, the development was different and both municipalities registered a continuing decline in voter turnout.

The 2014 elections reached 48.34%, which meant a slight decline. However, this decrease only occurred in the village of Dechtice, while the other examined municipalities showed a slight increase.

The last municipal elections in 2018 had a nationwide turnout of 48.67%, which is a very slight increase compared to 2014. Growing character was the result in the towns of Piešťany and Hlohovec, in the latter it was an increase of almost 3%. In selected villages the turnout had decreasing character, in the village Krakovany by almost 13%. However, this can be explained by single candidate for mayor - citizens did not feel the need to vote for their preferred candidate.

Despite the fact that the election turnout in the two examined villages has a rather decreasing character, in terms of percentage it is still far ahead from the turnout in the examined towns and even ahead the Slovak average. (Except for the last year of municipal elections in the village of Krakovany).

Summing up all years of municipal elections, we calculated an arithmetic average for each municipality examined, by means of which we expressed the average voter turnout for all monitored years.

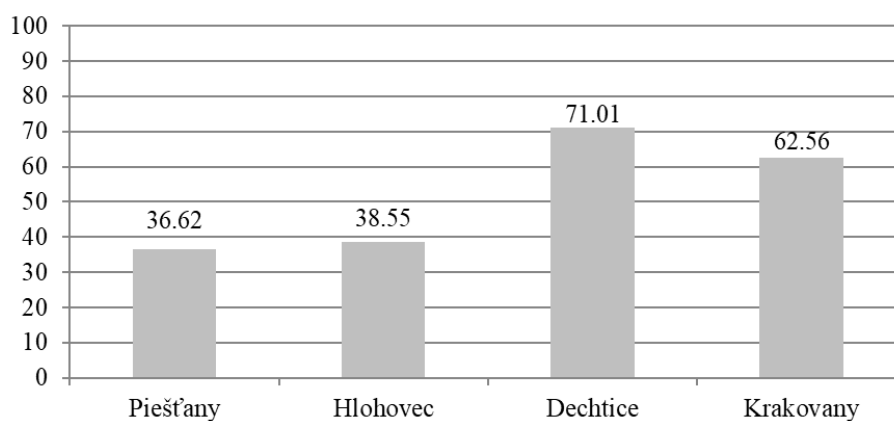

Fig. 1 – Average electoral turnout at municipal elections in selected municipalities. Source: SUSK (2019b)

As a result, voter turnout in villages significantly exceeds turnout in towns. The municipality with the highest average electoral turnout at municipal level is the village of Dechtice.

Tab. 3 – Average electoral turnout of villages in municipal elections. Source: SUSK (2019b)

Election type	Towns (average turnout)	Villages (average turnout)	Difference (in favour of villages)
Municipal elections	37.58	66.78	+ 29.2

In the case of villages, there is a significant difference, when the participation in municipal elections is almost 30% higher. The higher motivation to participate in municipal elections can be explained from a psychological and sociological point of view. Let us compare Piešťany and Krakovany, the municipalities with the largest and smallest population from our paper. 1,459 citizens living in Krakovany on an area of 982 ha have more opportunities for meetings, discussions and interactions than 27,534 citizens in Piešťany living on area of 4,420 ha. Citizens in villages develop a greater sense of belonging, are able to articulate and discuss their views and proposals directly. They do not feel so distant from the mayor and the municipal council, as they are more often in direct contact with MPs and employees and possible personal meetings are easier to appoint. In such an environment, the citizen is more aware of the importance and strength of his voice. In a city with a large population, the citizen feels more anonymous, rather gets into an individualistic mood and gets the feeling that his single vote or opinion will not change anything.

## 6 CONCLUSION

Citizens have good conditions for participation in all examined municipalities, the towns of Hlohovec and Piešťany and villages of Dechtice and Krakovany. Civic participation has suitable conditions for its development and it is respected and supported by local governments. Mayors of villages are actively responding to citizens' comments and promptly offer solutions, even via a private mobile phone, and towns offer simplified access to participation issues via the Internet and social networks, which is necessary due to the larger population. Citizens are offered enough room for expressing opinions in all selected municipalities, but they lack interest in certain issues. As evidence of this statement, we can mention the experience from the village of Krakovany, which gave citizens the opportunity to discuss the economic plan of the village and only one citizen attended the gathering. A possible problem is also the interest to participate by elected representatives, MPs, who do not always devote themselves to their duties and slack their attendance at council meetings.

However, the best known and best measurable indicator of participation quality is voter turnout. In Hlohovec and Piešťany, participation in municipal elections has been in a similar range over the past twenty years. In Hlohovec it is approximately 32-43%, in Piešťany approximately 33-39%. In one year, therefore, we can only talk about one-third of citizens voting in both cities, which is very unfavorable situation from the point of view of civic participation. Fortunately, this situation is a thing of the past, as evidenced by 43.37 percent electoral turnout in the last municipal elections in Hlohovec. The town of Piešťany has not yet managed to overcome the maximum turnout from 1998, Hlohovec surpassed it already in 2010. In both cases the turnout level has been increasing since the largest fall in 2006. In the monitored villages of Dechtice and Krakovany the participation in municipal elections shows different development. Unlike towns, there was no 2006 massive drop, the decline in turnout is gradual and persistent, at 64-76% in Dechtice and 45-73% in Krakovany. In all years of municipal elections, we can speak of a significantly higher voter turnout in the selected villages. If citizens have a common goal, they can organize themselves and participate, which is evident in petition activities that take place in all four selected municipalities. Thanks to the common interest in building a bike path, even several municipalities in the district of Piešťany joined together.

According to our findings, civic participation is well established in all four municipalities and does not suffer from any serious shortcomings from the side of local governments. On the other hand, reduced voter turnout does not affect only municipal elections, but is common for all types of elections organized in Slovakia. One example above all – 2014 European parliament elections reached 13% turnout in Slovakia, which was lowest result in the whole EU. It is not easy to name exact causes of this phenomenon, but we can assume that perception of voting and participation was deformed by long reign of communist party, and considered just as a pressure tool, a tool which helped to overthrow the totalitarian regime and create democratic country. After years, democracy became somehow natural, and the interest in elections and voting started to decrease. Behavioural patterns of Slovak citizens have not included the participation in a form of regular activity, watching over democratic ways of elected political representants. Younger generation thus lacked a role model in electoral and political participation, and had to slowly adapt itself. However, electoral participation on most levels started to improve during the last years and the character of voter turnout is mostly growing. Democracy is not something certain, as we are currently observing in the form of rising popularity of the extremist movements in Europe. Thus, using civic participation just as a pressure tool for transforming ill regime into democracy again, might be closer than lot of people think.

### **Acknowledgements**

This paper was created within the Cultural and Educational Grant Agency of the Ministry of Education, Science, Research and Sport of Slovak Republic (KEGA) project - Dynamika premien verejnej správy v Slovenskej republike, project registration number 001UCM-4/2019.

### **References**

- Dechtice (2018). *Obec Dechtice*. Retrieved from <https://www.dechtice.sk/>
- Filo, J. 2016. *Na spoločnom rokovaní v českých Krakovanoch*. Hlas Krakovian. Retrieved from <https://issuu.com/jurajfilo/docs/hk0316>
- Hlohovec (2019). *Mesto Hlohovec*. Retrieved from <http://mesto.hlohovec.sk/>

- Horváth, P., & Machyniak, J. (2018). The Practical Dimension of Civic Participation in Slovakia after 1989. In M. Mazur, V. Marinescu & D. Peicheva (Eds.), *Civic Participation in the Visegrad Group Countries after 1989*, 189-208. Lublin: UMCS Wydawnictwo Uniwersytetu Marii Curie-Skłodowskiej.
- Murín, A. (1996). *Kronika mesta Piešťany*. Retrieved from [http://www.piestany.sk/e\\_download.php?file=data/editor/189sk\\_8.pdf&original=Kronika\\_1992-1996.pdf](http://www.piestany.sk/e_download.php?file=data/editor/189sk_8.pdf&original=Kronika_1992-1996.pdf)
- OZ Katarínka (2001-2018). *Kláštor Katarínka*. Retrieved from <https://www.katarinka.sk/>
- Palkovič, M. (2017). *Minister dopravy vo Vrbovom: Nahradí železnicu cyklochodník?* Retrieved from <https://www.zpiestan.sk/spravy/minister-dopravy-vo-vrbovom-nahradi-zeleznicu-cyklochodnik/>
- Palkovič, M. (2018). *Nástup na cyklotrasu do Vrbového má byť pri skleníkoch SMP*. Retrieved from <https://www.zpiestan.sk/spravy/nastup-na-cyklotrasu-do-vrboveho-ma-byt-pri-sklenikoch-smp/>
- Piestany (2019). *Mesto Piešťany*. Retrieved from <https://www.piestany.sk/>
- Pirošík, V. (2005). *Participácia v samospráve: Nástroj protikorupčnej politiky*. Bratislava: Transparency International Slovensko.
- SUSK (2019a). *Veľkostné skupiny obcí*. Štatistický úrad Slovenskej republiky. Retrieved from [http://statdat.statistics.sk/cognosext/cgi-bin/cognos.cgi?b\\_action=cognosViewer&ui.action=run&ui.object=storeID\(%22i0C852CAA5451437C92774DB33EC08675%22\)&ui.name=Ve%c4%bektostn%c3%a9%20skupiny%20obc%c3%ad%20-%20SR%2c%20oblasti%2c%20kraje%2c%20okresy%2c%20mesto%2c%20vidiek%20%5bom7023rr%5d&run.outputFormat=&run.prompt=true&cv.header=false&ui.backURL=%2fcognosext%2fcps4%2fportlets%2fcommon%2fclose.html](http://statdat.statistics.sk/cognosext/cgi-bin/cognos.cgi?b_action=cognosViewer&ui.action=run&ui.object=storeID(%22i0C852CAA5451437C92774DB33EC08675%22)&ui.name=Ve%c4%bektostn%c3%a9%20skupiny%20obc%c3%ad%20-%20SR%2c%20oblasti%2c%20kraje%2c%20okresy%2c%20mesto%2c%20vidiek%20%5bom7023rr%5d&run.outputFormat=&run.prompt=true&cv.header=false&ui.backURL=%2fcognosext%2fcps4%2fportlets%2fcommon%2fclose.html)
- SUSK (2019b). *Volby a referendá*. Štatistický úrad Slovenskej republiky. Retrieved from <http://volby.statistics.sk/index.html>
- Trnavský hlas (2017). *Úrady považujú obavy starostov o zdroj pitnej vody v Dechticiach za predčasné*. Retrieved from <http://www.trnavskyhlas.sk/c/22471/urady-povazuju-obavy-starostov-o-zdroj-pitnej-vody-v-dehticiach-za-predcasne.htm>
- Višňovský, E. (2010). Občianska participácia ako problém kultúry In: J. Plichtová (Ed.), *Občianstvo, participácia a deliberácia na Slovensku*. Bratislava: VEDA.

## Contact information

### PhDr. León Richvalský

University of St. Cyril and Methodius in Trnava, Faculty of Social Sciences  
 Bučianska 4/A, 91701, Trnava, Slovak Republic  
 E-mail: [leon.richvalsky@gmail.com](mailto:leon.richvalsky@gmail.com)  
 ORCID: 0000-0003-3592-5495

doi: 10.7441/dokbat.2019.090



# CASE STUDY OF DIAGNOSTIC METHODS AND THEIR USE IN EMPLOYEE SELECTION

*Boris Rumanko, Zuzana Lušňáková, Mária Šajbidorová, Silvia Lenčėšová*

## **Abstract**

Many companies choose their employees only according to their education, experience and salary requirements. It is important for the healthy functioning of the company that the selection of employees, especially managers takes into account their personality characteristics, which we can examine using diagnostic methods in human resources. Their task is to reveal the hidden qualities of the candidates, from a personality point of view, which we cannot detect in basic contact. The aim of the article is to evaluate the personality characteristics of candidates for the position of marketing manager as one of the important pre-requisites of competence for the performance of the managerial position in our company. To achieve this goal, we used projective methods: trade with blue colour, a creative coat of arms and a motivation table. We found out, that selected candidates were very similar during the oral part of the interview. However, based on the research and application of diagnostic methods used in human resources management, we conclude that only one of these candidates fit personally to this position of the marketing manager. By the chosen research we pointed out the importance of focusing on personality in the selection of employees, especially in managerial positions.

*Keywords: diagnostic methods, human resources management, personality, employee selection, marketing manager*

## **1 INTRODUCTION**

Nowadays, the situation on a labour market has made many companies start to focus on the personality of candidates when selecting candidates for jobs. Research has shown that nowadays multinational companies need to be occupying in managerial positions of competent people who can work in an international team and the emphasis is also on their personality (Vetráková & Smerek, 2017). Personality is a qualitative feature, that is the main pre-requisite for mastering with claims, especially for managerial positions. Education and experience are a pre-requisite that managers can gain over time, however the personality is basically stable but develops throughout life. Especially in multinational enterprises, employers train and educate their employees, so they focus mainly on their personality when choosing. In order to obtain information about the candidates 'personality, diagnostic methods in human resources are used in practice, which are able to easily reveal information that candidates would not reveal themselves by means of projective methods.

## **2 THEORETICAL BACKGROUND**

The main task of selecting employees is to compare candidates with the requirements of the organization and to choose the most suitable candidate between all candidates. The quality of candidates is becoming an increasingly important factor in employee selection. For this reason, the HR department should make every effort to implement a quality selection process in the area of recruitment and selection (Gontkovičová, 2016). One of the possibilities of employee selection is also the use of diagnostic methods, which are included the new trends in the area of human resources management (Lušňáková, Lenčėšová & Hrdá, 2019). Diagnostic methods are used in the practice of human resources management to determine personal, social and

professional characteristics (Evangelu, 2009). Their task is to provide HR employees information on two options: (i) for the selection of candidates; and (ii) for the position and development of employees (Gruber, Kyrianová & Fonville, 2016). One of the advantages of these methods is that they can eliminate candidates with a personality disorder during job interviews, who can succeed at the job interview but can be destructive in the team (Gruber, Kyrianová & Fonville, 2016). We call these people "social chameleons" because of the difficulty of their detection (Babiak & Hare, 2006). Nowadays, the personality pre-requisites for the job are extremely important in an extremely turbulent environment, globalization, information asymmetry and permanent innovation (Juríčková, Kapsdorferová & Kadlečíková, 2018). As there is still a traditional approach to working with human resources in a large number of companies, there is a need to change this approach because of the need to unlock human potential (Šajbidorová, Lušňáková & Dobišová, 2016). According to Gulisová (2019a), instead of professional skills, so-called hard skills, the advertisements of companies are increasingly appearing requirements that are more personality-oriented. Companies agree that they are more inclined to tests that reveal personality traits, cognitive abilities, as well as ways of making decisions for those interested (Gulisová, 2019b). It is also important that employees find an organization that is right for them and offers them a place for development where they can develop their personality in addition to skills (Šajbidorová, Lušňákové & Brúnaiová, 2017).

Diagnostic methods can be performed in groups or individually, depending on the specific methods and characteristics that we want to examine. According to the output data provided by diagnostic methods, we divide them into: (a) Tests - focus on intelligence, special skills and special skills; (b) Questionnaires - focus on the nature of man; and (c) Projective methods - focus on the abilities of diagnosed persons in addition to personality. The main advantage of projective methods is that diagnosed individuals cannot subconsciously influence responses because they are unable to identify the characteristics we are targeting (Evangelu, 2009; Evangelu & Neubauer, 2014).

When using diagnostic methods we work with sensitive information of individual candidates, therefore, in their implementation, recruiters should follow the following ethical rules: (1) We must inform each participant about testing; (2) All participants must be informed and accepted, who will have access to the test results; (3) Testing must be voluntary; (4) The right to refuse testing shall not be denied; (5) A third party may not have access to the test results without the participant's permission; (6) The conditions for administration of the methods should be the same for all participants; (7) Participants have the right to know what the test results will be treated; (8) Participants have the right to administer methods in good health; (9) Test participants have the right to know at a general level what characteristics are tested; and (10) Each participant has the right to know the output of the methods (in writing or orally) (Slováčková, Horáková a Rendoš, 2014; Seitl, 2015).

One of the personality areas that these methods reveal to us is personality characteristics, which we define as innate dispositions or inherited properties serving as a basis for the social and professional field. They influence the thinking, decision-making and behaviour of individuals. The value of these characteristics is stable and does not change very much over the course of life, but they may develop as a result of social experience or wisdom that comes with age and survival of various life situations that may weaken or strengthen certain characteristics. Personality characteristics include: strategic thinking, creativity, analytical thinking, logical thinking, operative decision-making, adaptation to the environment, etc. (Evangelu, 2009). The personality characteristics that every manager should possess should be originality, peculiarity, coherence, stability and liveliness (Šajbidorová, Lušňáková & Hrdá, 2018).

The importance of selecting employees on the basis of personality helps prevent burn-out syndrome, whose causes are, besides stress, insufficient fulfilment of expectations, also personality (Brunajová, Šajbidorová & Košuda, 2017). The phenomenon of burnout causes huge waste of education and talent of many employees (Przewoźna-Krzemińska, 2017). Therefore, the question arises as to whether people with the same education and similar experience are personally fit for the same job?

### 3 METHODOLOGY

The aim of the paper is to evaluate the personality characteristics of candidates for the post of marketing manager as one of the important prerequisites of competence for the performance of managerial position in the international company, which operates in the field of engineering.

The selected company is an engineering company that was established in 2007. The company is part of a group of companies with headquarters in Germany and 35 branches worldwide. The company is a leader in complete system solutions for the production of Smart Labels, Smart Cards, Back-End and Vision systems. The company also focuses on activities in the field of youth education. It cooperates with secondary universities, in particular with a technical focus, and offers internships to students in Slovakia as well as in the Group headquarters through the Erasmus program.

For research we chose the position of marketing manager for Slovakia. There was no separate marketing department in the Slovak branch and marketing activities were covered by the HR department. Due to the expansion of the company in Slovakia, the company decided to create a marketing department focusing on the Slovak market. The main job of the marketing manager will be PR activities, company presentation at various events, creation of marketing strategy and participation in company projects.

According to the company personnel officer, the candidate must have the following personality characteristics: (a) Strategic thinking - it is necessary for the development of marketing strategy of the company; (b) Creativity - as marketing is a dynamically developing direction, it is essential that the manager in this position is capable of creative thinking and, in addition to the creative manager, also becomes the manager of creativity; (c) Logical thinking; (d) Operational decision making - the need for quick decision making and flexibility in team management; and (e) Adaptation to the environment - important when working in an international team.

The number of candidates, which were shortlisted, was five. They were between 25 and 30 years old and all of them had a university degree in marketing. Further identification is shown in Table 1.

Tab. 1 – Characteristics of candidates. Source: own research

	Sex	Age	Education	Work experience	Language level
candidate 1	female	27	Marketing communication and advertising	social media marketing	B2
candidate 2	female	28	Agrarian trade and marketing	event organization, administration	C1
candidate 3	female	25	Agrarian trade and marketing	communication with customers	B2
candidate 4	female	25	Marketing communication and advertising	hostess	C1
candidate 5	male	26	Marketing communication and advertising	social media marketing	B1

Based on the personal characteristics required by the company, we decided on the following projective methods: (1) Trade with blue colour; (2) Creative coat of arms; and (3) Motivation table. (Evangelu, 2009)

**Trade with blue colour** - The method focuses on strategic thinking, operative decision-making, level of creativity and vocabulary. The method consists of selling an abstract thing – blue colour. The diagnosed person has to deal with the fact that he does not sell anything specifically such as colour for painting, but only owns the abstraction of blue. In evaluating, we used a table consisting of the points we noticed in the diagnosed person (Evangelu, 2009).

Tab. 2 – Trade with blue colour. Source: own research

Name:	Yes	No
1 Preparatory analysis for obtaining arguments (questioning, key points, goal, strategy, etc.)		
2 Ability to solve abstract assignment and to present it interestingly		
3 Differences in response to emotional and rational objections		
4 Adequate nonverbal communication		
5 Asking the customer		
6 Ability to draw conclusions, ask final questions and summarize		
7 Adequate arguments and replies to objections		
8 Use of business and bargaining tricks (rhetorical questions, comparisons, etc.)		

**Creative coat of arms** - The method focuses on adaptation to the environment, openness to new impulses, creativity, analytical and logical thinking and final precision. It consists of newspaper and magazine clippings, clean paper and glue. The candidate attaches the selected images to the paper at his / her own discretion. The diagnosed person builds up his ranking by means of his personal coat of arms. Sufficient images are important for the method. Images are intended to symbolize certain values, they may not accurately represent them. With this in mind, it is important that the diagnosed person adds their own description to the selected images. We can see their adaptability to an unknown environment according to the speed at which they begin the task. The accuracy and order of the coat of arms speaks of logical and analytical thinking, introversion, precision and planning. On the contrary, if the pictures are subject to colour and colour, it speaks of extroversion, global thinking and teamwork. We also notice that they adhere to the specified format. Failure to observe the defined area, speaks of the creativity of the diagnosed person. If the personal coat of arms is dominated by pictures from the work area, the individual is task-oriented and planned. She focuses on motivation and teamwork in family and hobby images. The method also reveals to us the personal and professional goals of the respondent in the form of pictures on the right side of the coat of arms. On the left side, we will find out their past experience (Evangelu, 2009).

**Motivation table** - The method focuses on creativity, strategic thinking, operative decision-making, analytical thinking, dominance, concentration and openness to new impulses. It is important that diagnosed individuals do not know the name of the activity because of the bias in the results. Diagnosed persons only work with paper and pencil. Their task is to draw a table with 10 rows and 11 columns, then write 10 professions and for each 10 characteristics. Depending on the speed at which the diagnosed person begins to perform the task, we see the ability to adapt to an unknown environment. The pressure on the pencil shows us the dominance and layout of the table in the space of self-enforcement of the diagnosed person. We also notice the layout and scheduling of the table. The more precise and structured each row is, the more thorough it is. If the table is made from the eye, it reflects the creativity of the individual. The three most common categories of terms point to the motivator of the diagnosed person (Evangelu, 2009).

All candidates were informed about the research and its further processing. Candidates were guaranteed anonymity in the use of research results and all agreed to testing.

## 4 THE RESEARCH

The selected methods were implemented individually in the selection of employees in the second round of job interviews. Based on the results provided by the diagnostic methods, we evaluated the candidates as follows:

### 4.1 Trade with blue colour

For each candidate, we were given an assignment which reads: “You are a trader selling blue. You do not sell paint, but only an abstract product, a shade that only you own. Your job is to persuade me to buy this blue colour from you. “They were then given two minutes to think through, as well as a pen and notepaper. By the chosen method we found the following characteristics:

Tab. 3 – Trade with blue colour - Personality Characteristics. Source: own research

	Creativity	Strategic thinking	Operative decision-making
candidate 1	+	-	+
candidate 2	+	+	+
candidate 3	-	-	-
candidate 4	+	+	+
candidate 5	+	-	-

Applying the “Trade with blue colour” method, we found that Candidate 1 is able to make operational decisions, and can also use creativity. His weakness was strategic thinking and communication. The Candidate 2, who has all the requirements examined by the method, has the best handled the chosen method. We would also positively evaluate his communication skills. The assessed personality characteristics are evaluated at the candidate 3 at a weaker level than required by the job. Although we have observed these characteristics at a weaker level, we see room for their development as we have taken into account age and work experience to date. The method highlighted the creativity, strategic thinking and operational decision-making of the candidate 4. We also appreciate communication very positively, when the candidate showed the desire to become a sales representative, especially regarding non-verbal communication and access to the customer. At candidate 5, we encountered slight negativity after starting the task of a merchant with a blue colour, which was also reflected in the answers. Although he chose a creative sales path, he did not further develop his creativity. We would also evaluate the weaker level of strategic thinking and operational decision making.

### 4.2 Creative coat of arms

In the chosen method based on the pictures, the candidates were supposed to build their personal coat of arms, which symbolized their personality, hobbies, weaknesses and strengths. On the basis of the pictures, which candidates chose and were only symbols, the candidates explained why they had decided for specific pictures. Based on the answers and the layout of the coat of arms, we found out:

Tab. 4 – Creative coat of arms - Personality Characteristics. Source: own research

	Creativity	Adaptation on social environment	Logical thinking
candidate 1	+	-	+
candidate 2	-	+	-
candidate 3	-	+	+
candidate 4	+	+	+
candidate 5	+	-	+

The creative coat of arms method revealed a slower adaptation to the new conditions of candidate 1, but according to the processing we confirmed her creativity, which was also

revealed by the previous method. According to personality goals, we found that the respondent would like to maintain the standard that he currently has. However, we can say that he would like to be more passive. We also uncovered manifestations of extrovert, global and logical thinking. Given the job position, the big advantage is that the candidate is a team player according to the method. The results of the Candidate 2 in Coat of Arms method revealed high adaptability to an unknown environment and a high degree of self-enforcement. Candidate 2 is open to new opportunities in personal and professional goals. The evaluation of the task showed the candidate's extroversion and task focus. Candidate 3 had high adaptability to an unknown environment. His personal and professional goals are harmonious relationships with the environment. The arrangement of the pictures showed good logical and analytical thinking and revealed that the candidate was an introvert. This fact was also confirmed by the result of self-dignified performance that dominates the applicant. The results of this method also brought us information that the candidate can work in a team. By the candidate 4 we observed rapid adaptability to an unknown environment, as well as logical and analytical thinking. According to the layout of the pictures, we found out that the candidate tends to be accurate, has a high level of self-promotion and can work in a team. Method of creative estimation for lower adaptability of applicant 5 to unknown environment, an unknown confirmation of his creativity. Although according to the results, we found that the candidate is an introvert, he is a team player. The ability to self-enforce by methods does not dominate the candidate.

### 4.3 Motivation table

The motivation table was the most time-consuming method for candidates. They were given 25 minutes after the task assignment. They had to draw a table and write 10 professions and 10 characteristics. After about 20 minutes, we told them that it would be enough if they had 7 characteristics for each profession. The method revealed the following characteristics:

Tab. 5 – Motivation table - Personality Characteristics. Source: own research

	Creativity	Strategic thinking	Operative decision-making
candidate 1	+	-	+
candidate 2	+	+	+
candidate 3	-	-	+
candidate 4	-	+	+
candidate 5	+	-	-

In the motivation table, candidate 1 has shown passivity, lack of dominance, and self-enforcement. In consequence of method, we have also found that a candidate in the workplace prefers to work in condition of friendliness, a sense of responsibility and the possibility of creative work. Candidate 2 has dominance with a high degree of self-enforcement and a high degree of assertiveness, friendliness and communicativeness. The motivation table also revealed a high level of self-promotion in Candidate 3 but did not show dominance. Among his strongest qualities belongs to friendliness, which can motivate him in the work environment, expertise and mastery of skills that are needed in a job. Candidate 4 has shown dominance with considerable self-promotion and creativity. We also found that fair leadership, interpersonal relationships and workplace expertise are the most motivating candidates. The motivation table revealed a strong level of self-promotion by candidate 5, but with no sign of dominance. The method revealed to us that he was in favour of both strictness and fairness in the working environment.

Based on the application of diagnostic methods in the interview, we can summarize our findings in Table 6.

Tab. 6 – Motivation table - Personality Characteristics. Source: own research

	Creativity	Strategic thinking	Operative decision-making	Adaptation on social environment	Logical thinking
candidate 1	+	-	+	-	+
candidate 2	+	+	+	+	-
candidate 3	-	-	+/-	+	+
candidate 4	+	+	+	+	+
candidate 5	+	-	-	-	+

Based on the personality characteristics that have been diagnosed, we recommend that the company opt for candidate 4, who we consider to be the most suitable candidate for the position. For the other tenderers, not all the characteristics required by the company were demonstrated. Candidate 1 did not meet the requirements of adaptation to the unknown environment and the requirement of strategic thinking. Candidate 2 revealed weaker logical thinking based on projective methods. Candidate 3 showed a weak level of creativity and strategic thinking. Candidate 5, based on diagnostic methods, only observed creativity and logical thinking at the required level.

## 5 CONCLUSION

The usage of diagnostic methods is a great benefit to recruiters. In practice, during job interviews, we found out that candidates have similar experience and education and therefore it is difficult for recruiters to choose the right one. Often, this choice is influenced by the "Hello effect" or salary requirements, where the HR specialist focuses on lower labour costs. Although, after the selection, the HR may think that he has chosen the right candidate, over time the candidate may be inappropriate for personality. For this situation it is possible to use diagnostic methods in human resources, where we also focus on candidates' personality, not just education and experience. By choosing an employee for a job that he/she is not personally prepared for, we can also hurt him/her. Failure to cope with work demands may result in burn-out syndrome for employees. Proper employee selection reduces overall turnover in the company. We have found out that people with the same education and similar experience are not always personally suited to the same job. In practice, personality diagnostics should not only be used for employee selection but also for core employees, thus helping to develop them.

### Acknowledgements

This paper was created within the KEGA project Theory and practice of human resources management and managerial work. Project registration number 041SPU-4/2018.

### References

- Babiak, P., & Hare, R. (2007). *Snakes in Suits: When Psychopaths Go to Work*. New York: HarperCollins.
- Brunajová, Z., Šajbidorová, M., & Košuda, J. (2017). *Assessment of the level of burnout syndrome among managers depending on the gender of the respondents*. Paper presented at the 7th International Scientific Conference (ICoM 2017): Managerial Trends in the Development of Enterprises in Globalization Era, Nitra, Slovakia. Retrieved from [https://spu.fem.uniag.sk/fem/ICoM\\_2017/files/international\\_scientific\\_conference\\_icom\\_2017.pdf](https://spu.fem.uniag.sk/fem/ICoM_2017/files/international_scientific_conference_icom_2017.pdf)

- Evangelu, J. E. (2009). *Diagnostické metódy v personalistice*. Praha: Grada.
- Evangelu, J. E., & Neubauer, J. (2014). *Testy pro personální práci*. Praha: Grada.
- Gontkovičová, B. (2016). *Actual trends in recruitment and selection of employees*. Paper presented at the Scientific workshop: New Trends in Management and Marketing 2016, Horný Smokovec, Slovakia. Retrieved from [https://phf.euba.sk/www\\_write/files/veda-vyskum/zborniky/nove-trendy-v-manazmente-a-marketingu-2016.pdf](https://phf.euba.sk/www_write/files/veda-vyskum/zborniky/nove-trendy-v-manazmente-a-marketingu-2016.pdf)
- Gruber, J., Kyrianová, H., & Fonville, A. (2016). *Kvalitativní diagnostika v oblasti lidských zdrojů*. Praha: Grada.
- Gulisová, S. (2019a). *Do nového zamestnania bez odborných znalostí? Firmy postupne dávajú prednosť osobnosti*. Forbes. Retrieved from <https://www.forbes.sk/profesnia-makke-zrucnosti-zamestnanie/>
- Gulisová, S. (2019b). *Firmy začínajú využívať osobnostné testy. Niekedy sa s nimi stretnete počas pohovoru, inokedy po ňom*. Forbes. Retrieved from <https://www.forbes.sk/osobnostne-testy-pohovor-zamestnanie/>
- Juričková, Z., Kapsdorferová, Z., & Kadlečíková, M. (2018). *Nové prístupy a inovačné aktivity v manažmente poľnohospodárskych podnikateľských subjektov*. Praha: Wolters Kluwer.
- Lušňáková, Z., Lenčéšová, S., & Hrdá, V. (2019). *Nové trendy v teórii a praxi manažmentu ľudských zdrojov*. Nitra: SPU.
- Przewoźna-Krzemińska, A. (2017). *The role of professional burnout in human resources management*. Paper presented at the 7th International Scientific Conference (ICoM 2017): Managerial Trends in the Development of Enterprises in Globalization Era, Nitra, Slovakia. Retrieved from [https://spu.fem.uniag.sk/fem/ICoM\\_2017/files/international\\_scientific\\_conference\\_icom\\_2017.pdf](https://spu.fem.uniag.sk/fem/ICoM_2017/files/international_scientific_conference_icom_2017.pdf)
- Seitl, M. (2015). *Testové psychodiagnostické metódy pro vyber zamestnancu*. Olomouc: UP.
- Slováčková, Z., Horáková, P., & Rendoš, D. (2014). *Průvodce personální psychologií*. Brno: MU.
- Šajbidorová, M., Lušňáková, Z., & Hrdá, V. (2018). *Organizácia manažérskej práce*. Nitra: SPU.
- Šajbidorová, M., Lušňáková, Z., & Dobišová, M. (2016). *Management of human resources in agricultural sector enterprises*. Paper presented at the International Scientific Days 2016 – The Agri-Food Value Chain: Challenges for Natural Resources Management and Society, Nitra, Slovakia. doi: 10.15414/isd2016.s3.08
- Šajbidorová, M., Lušňáková, Z., & Brúnaiová, Z. (2017). *Career management*. Paper presented at the 7th International Scientific Conference (ICoM 2017): Managerial Trends in the Development of Enterprises in Globalization Era, Nitra, Slovakia. Retrieved from [https://spu.fem.uniag.sk/fem/ICoM\\_2017/files/international\\_scientific\\_conference\\_icom\\_2017.pdf](https://spu.fem.uniag.sk/fem/ICoM_2017/files/international_scientific_conference_icom_2017.pdf)
- Vetráková, M., & Smerek, L. (2017). *Particularities in Human Resources Management in Multinational Companies*. Paper presented at the 7th International Scientific Conference (ICoM 2017): Managerial Trends in the Development of Enterprises in Globalization Era, Nitra, Slovakia. Retrieved from [https://spu.fem.uniag.sk/fem/ICoM\\_2017/files/international\\_scientific\\_conference\\_icom\\_2017.pdf](https://spu.fem.uniag.sk/fem/ICoM_2017/files/international_scientific_conference_icom_2017.pdf)



## **Contact information**

### **Ing. Boris Rumanko**

Slovak University of Agriculture in Nitra, Faculty of Economics and Management  
Tr. A. Hlinku 2, 94976, Nitra, Slovak Republic  
E-mail: xrumankob@uniag.sk  
ORCID: 0000-0002-3320-8508

### **Ing. Zuzana Lušňáková, PhD.**

Slovak University of Agriculture in Nitra, Faculty of Economics and Management  
Tr. A. Hlinku 2, 94976, Nitra, Slovak Republic  
E-mail: zuzana.lusnakova@uniag.sk  
ORCID: 0000-0001-6331-9930

### **doc. Ing. Mária Šajbidorová, PhD.**

Slovak University of Agriculture in Nitra, Faculty of Economics and Management  
Tr. A. Hlinku 2, 94976, Nitra, Slovak Republic  
E-mail: maria.sajbidorova@uniag.sk  
ORCID: 0000-0002-7120-7653

### **Ing. Silvia Lenčesová**

Slovak University of Agriculture in Nitra, Faculty of Economics and Management  
Tr. A. Hlinku 2, 94976, Nitra, Slovak Republic  
E-mail: xlencesovas1@is.uniag.sk  
ORCID: 0000-0001-5826-3813

doi: 10.7441/dokbat.2019.091

# METHODOLOGY FOR APPLICATION OF NON-PARAMETRIC METHODS OF STATISTICAL PROCESS CONTROL INTO PRACTICE

*Tereza Smajdorová, Darja Noskievičová*

## **Abstract**

Classical parametric statistical methods are based on several basic assumptions about data (normality, independence, constant mean and variance). Unfortunately, these assumptions are not always fulfilled in practice, whether due to problems arising during manufacturing or because these properties are not typical for some processes. Either way, when we apply parametric methods to such data, whether Shewhart's or other types of parametric control charts, it is not guaranteed that they will provide the right results. For these cases, reliable non-parametric statistical methods were developed, which are not affected by breaking assumptions about the data. Non-parametric methods try to provide suitable procedures to replace commonly used parametric statistical methods. Non-parametric methods are not affected by outlying values or other deviations from model assumptions. Non-parametric procedures are used when the above data assumptions are not met. In practice, non-parametric methods are not known, which is due, among other things, to the lack of comprehensive guidance for their application. The aim of this paper is to present the methodology developed for the application of non-parametric control charts that was created on the basis of simulation results. Simulations were realized for in-control process and also for out-of-control process. The out-of-control process is divided into a process with persistent and isolated deviation. The simulation results showed that the highest performance over different breaches of assumptions about data have non-parametric Shewhart sign control chart and CUSUM control chart.

**Keywords:** *nonparametric control chart, statistical process control, simulations of in-control process, simulations of out-of-control process*

## **1 INTRODUCTION**

Classical parametric statistical methods are based on several basic assumptions about data (normality, independence, constant mean and variance). Unfortunately, these assumptions are not always fulfilled in practice, whether due to problems arising during manufacturing or because these properties are not typical for some processes. Either way, when we apply parametric methods to such data, whether Shewhart's or other types of parametric control charts (CC), it is not guaranteed that they will provide the right results. For these cases, reliable non-parametric statistical methods were developed, which are not affected by breaking assumptions about the data. (Jarošová & Noskievičová, 2015; Bakir, 2015)

Non-parametric methods try to provide suitable procedures to replace commonly used parametric statistical methods. Non-parametric methods are not affected by outlying values or other deviations from model assumptions (Bakir, 2015). Non-parametric procedures are used when the above data assumptions are not met (Dempír & Dohnal, 2005).

In practice, non-parametric methods are not known, which is due, among other things, to the lack of comprehensive guidance for their application. The aim of this paper is to present the methodology developed for the application of non-parametric control charts (NPCC) that was created on the basis of simulation results. An overview of the advantages and disadvantages of the non-parametric control charts that were analysed in this study is given in Table 1. Non-parametric control charts for monitoring position SSCC (Bakir, Prater & Kiser, 2001), NP-

EWMA (Lu, 2015), NP-CUSUM (Wang, Zhang & Xiong, 2016), PM (Škapa, 2002), NPCC for monitoring variability Mood (Murakami & Matsuki, 2016), and MAD (Adekey & Azubuike, 2012) have now been analysed.

Tab. 1 – Advantages and disadvantages of non-parametric control charts. Source: own research

<b>Non-parametric Control Chart (NPCC)</b>	<b>Advantages</b>	<b>Disadvantages</b>
Shewharts Sign CC (SSCC)	Easiest NPCC Easy calculations	Not too strong non-parametric statistics
NP – EWMA (NPEWMA)	NPCC with memory	More complicated calculations of control limits
NP – CUSUM (NPCUSUM)	Quickly reveals small and middle changes in the process NPCC with memory	More complicated calculations of needed statistics
Progressive Mean (PM)	Statistics of progressive mean is considered more powerful than classic Shewhart CC or CUSUM and EWMA More effective in detecting small shifts in the process NPCC with memory	More complicated calculations
Median Absolute Deviation (MAD)	It's the most used non-parametric control chart when normality assumption fails Works with robust statistics via median	More complicated calculations This is not a CC with memory
NPCC based on Mood statistic (Mood)	Mood's statistics is considered one of the strongest non-parametric statistics	More complicated calculations This is not a CC with memory

The paper is structured as follows: in the chapter 2 the design of SW support for non-parametric control charts in MS excel is described. The chapter 3 is devoted to the design of simulations for evaluation of performance of the selected non-parametric control charts (Tab. 1) and their evaluation for in-control process. The chapter 4 is dedicated to the same issues but for the out-of-control process. In the chapter 5 the design of the methodology for the non-parametric control charts practical application is described.

## **2 DESIGN OF SW SUPPORT FOR NON-PARAMETRIC CONTROL CHARTS IN MS EXCEL**

Before starting the simulations, the SW support for the construction of non-parametric control charts in MS Excel was created. This SW support was created not only for the construction of selected non-parametric control charts, but also for the realization of simulations in order to evaluate their performance.

The logic of the created SW support is illustrated and explained on the example of SSCC and data file of the size of 20 subgroups each of size of 5 units. Other non-parametric control charts were processed on the same basis. Fig. 1 shows a general view of an MS Excel sheet designed to construct SSCC. The table on the left (part A of the sheet) is used for the input values. On the right of the table “A” (part B of the worksheet) is basic information such as the number of subgroups and their size, mean value, standard deviation and other characteristics needed for further calculations. The largest table in the middle (part C of the sheet) is used to calculate the characteristics needed to construct the CC. It also includes the calculation of the RL (Run Length) value (part D of the sheet). In addition to this table, the calculated performance indicator values (part E of the sheet). Under the table the resulting CC (part F of the sheet) is constructed. All calculations and graphs are created automatically after entering the input values.

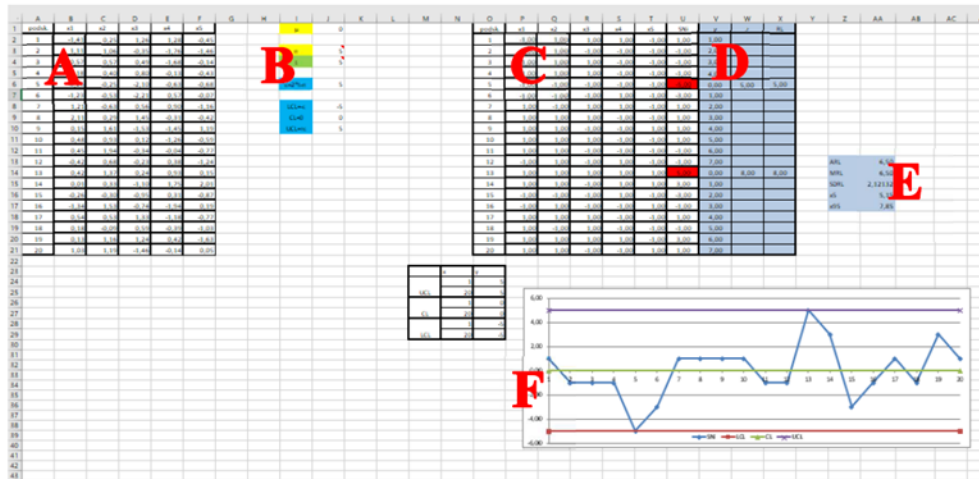

Fig. 1 – Created SW support. Source: own research

### 3 SIMULATION DESIGN FOR IN-CONTROL PROCESS

In-control process means statistically stable process when only random causes have an influence on it. The following table (see Tab. 2) describes the types of probability distributions that were used to simulate various breaches of assumptions about data.

Tab. 2 – Overview of types of probability distributions. Source: own research

Distribution no.	Distribution/Type of breach of assumption	Distribution parameters	Unfulfilled assumption of data
1.	Normal distribution	$N(0,1)$	Neither
2.	Student's distribution/ greater kurtosis than the normal distribution	$t_3$	Data normality
3.	Uniform distribution/ less kurtosis than the normal distribution	$R(-\sqrt{3}; \sqrt{3})$	Data normality
4.	Pearson distribution/ skewed distribution	$\chi_3^2$	Data normality
5.	Mixed distribution	50% $N(0,1)$ + 50% $N(2,1)$	Constant mean
6.	Mixed distribution	50% $N(0,1)$ + 50% $N(0,4)$	Constant variance
7.	Time series Autocorrelated data	AR (1): $x_i - 0.5x_{i-1} + a_i$	Independence of data

The number of the subgroups  $m$  was equal to 20, 100 and 300, and the size of the subgroup  $n$  was chosen to be 5 and 10. 10,000 replicates were performed. The  $m$  and  $n$  values were chosen based on the results of the in-control simulations (Chen, 1997; Chakraborti, 2007), so that the ARL was approximately 370 (Shannon, 1975; Dhar, 2017). The indicators Average Run Length ARL(0), Median Run Length MRL(0) and five percent quantile ( $x_5$ ) will be used to evaluate the performance of individual NPCC. ARL(0), MRL(0) and  $x_5$  are based on the Run Length for in-control process and is referred to as RL(0). RL(0) is determined as the number of points recorded in CC that lie within the control limits, between 2 points outside these limits. This methodology of simulations is similar for all non-parametric control charts included in this study (Low et al., 2012; Jarošová & Noskiewiczová, 2015; Smajdorová, 2019).

As an example of this part of the simulation, let's take a sample of 100 values generated from the normal distribution. We will construct NPCC SSCC working with the statistic  $S_{ni}$  (Bakir, Prater & Kiser, 2001). This sample is divided into 20 subgroups of size 5. From these values the UCL and LCL control limits are calculated. These limits are recorded in the CC. Subsequently  $n$  values from the normal distribution for particular subgroups are generated and the  $S_{ni}$  characteristic is calculated from them and recorded in the CC. Subsequently, RL(0)

values are calculated. And from them values of performance indicators ARL(0), MRL(0) and x5 are then calculated. This step is performed ten thousand times.

### 3.1 Results of simulations of the in-control process

In order to create a methodology for the practical application of non-parametric control charts (NPCC), it was necessary to carry out a number of analyses that will be presented below on some selected graphs and tables. All results can be found in Smajdorová (2019).

**Selection of performance indicators:** First, attention should be paid to the individual performance indicators and the selection of the ones that are most stable for different probability distributions (see Tab. 2) and for that reason the most suitable for evaluation of performance of various NPCC (see Tab. 1). An example of the resulting graph for SSCC with the number of subgroups ( $m = 20$ ) and subgroup size ( $n = 5$ ) is shown in Fig. 2.

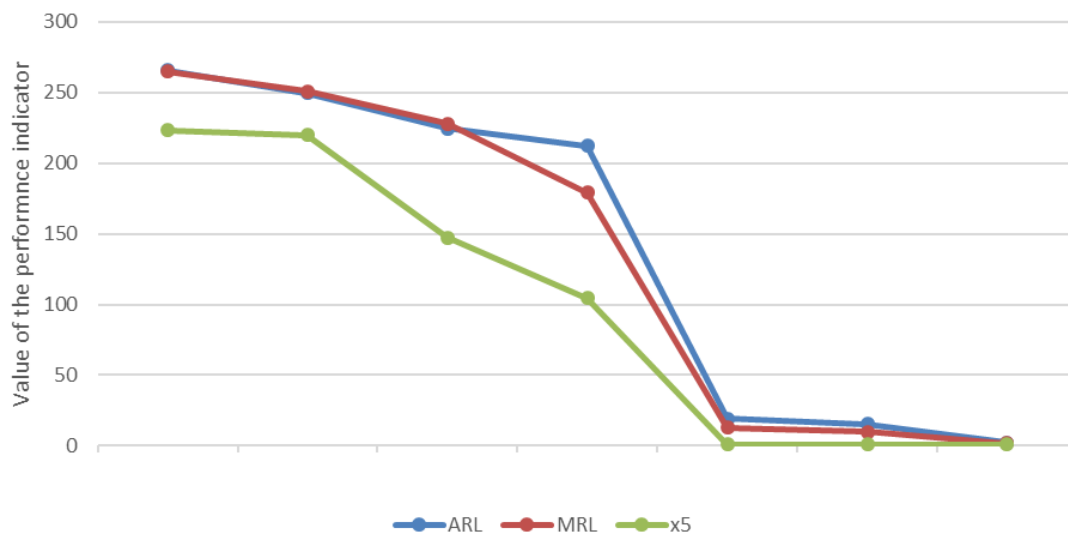

Fig. 2 – Values of performance indicators for different probability distributions. Source: own research

Similar graphs were constructed and analysed for all the rest of analysed NPCC (see Tab. 1). To analyse the quality of process performance indicators, their values were sorted in descending order. The resulting curves show the stability of individual indicators for different distributions, i.e. for different deviations from data assumptions. The more slowly the curve decreases, the more stable the indicator of performance is. Conversely, if the curve decreases too rapidly, the performance indicator is less stable. Based on this comparison of the quality of individual performance indicators done for various NPCC (see Tab. 1) in combination with different subgroup sizes and various probability distributions (see Tab. 2), we came to the general conclusion that 5% - quantiles have the most stable values for different deviations from the data assumptions. As regards the ARL(0) and MRL(0) performance indicators, the MRL(0) indicator is more stable than the ARL(0). Therefore, further performance analysis of individual NPCCs was performed using only the x5 and MRL(0) performance indicators. (Smajdorová, 2019)

**Performance analysis of non-parametric control charts:** The analysis of performance of investigated NPCC in combination with various number of subgroups and different subgroup sizes was realized using graphs of MRL(0) or x5 for different applied probability distributions (see Tab. 2). Fig. 3 is an example of such graph where MRL(0) values in a case of normal distribution are depicted. Such graphs of MRL(0) for the rest of applied distributions and the same graphs of x5 for all applied distributions can be found in Smajdorová (2019).

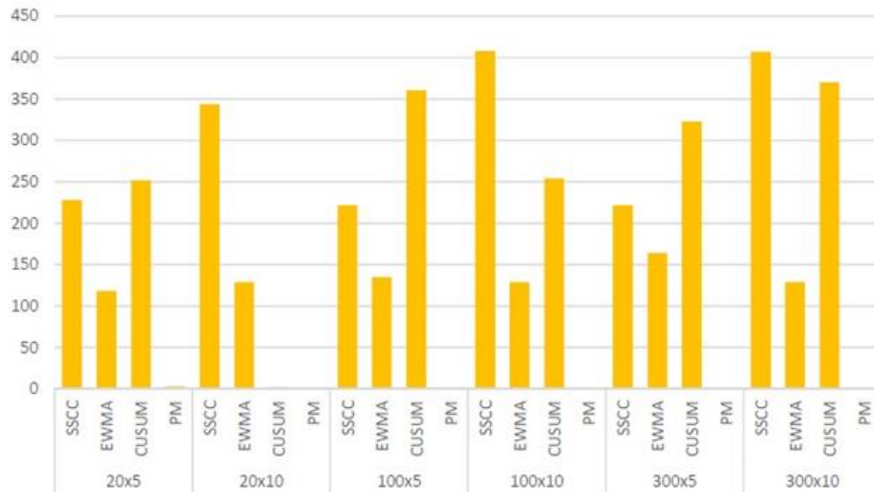

Fig. 3 – MRL(0) values for different types of NPCC in a case of normal distribution. Source: own research

Based on the previous analysis we can determine which non-parametric control chart is most suitable for the given data assumption violation. The results for NP – CUSUM and SSCC are shown in the following Table 3.

Tab. 3 – Performance analysis results. Source: own research

<b>NP - CUSUM</b>	<b>SSCC</b>
Non-constant mean value	Autocorrelation data
Non-constant variance	Non-constant mean value
Greater kurtosis than normal distribution	Skewed distribution
Skewed distribution	Greater kurtosis than normal distribution

These CC were determined as quite robust (universal) CC and from them the most robust CC (i.e. the one that has the most stable performance indicator values over all probability distributions) was set. Our analysis showed that the most universal CC is control chart SSCC, where the performance indicator values are most stable for different probability distributions, i.e. for different deviations from data assumptions. (Smajdorová, 2019)

**Performance analysis of non-parametric control charts for variability monitoring:** Non-parametric control charts for monitoring variability (Mood and MAD) have now been analysed. Based on the results of performance indicators it was determined which of them is more suitable for the given data assumption violation. The results of analysis of non-parametric control charts for variability monitoring are given in Table 4. (Smajdorová, 2019)

Tab. 4 – Results of analysis of non-parametric control charts for variability monitoring. Source: own research

<b>Mood</b>	<b>MAD</b>
Non-constant mean value	Less kurtosis than normal distribution
Non-constant variance	Greater kurtosis than normal distribution
Autocorrelation data	
Skewed distribution	

#### 4 SIMULATION DESIGN FOR THE OUT-OF-CONTROL PROCESS

The out-of-control process means that the process is statistically unstable i.e. it is influenced by random and also assignable causes of variation. The number of the subgroups  $m$  was equal to 20, 100 and 300, and the size of the subgroup  $n$  was chosen to be 5 and 10. A total of 10,000 repeats were performed for each combination of  $m$  and  $n$  and for a particular type of distribution.

The simulations were realized in the same way as experiments for in-control process (see chapter 3). But unlike the experiment for in-control situation during the second experiment,

deviations of different sizes  $\delta$  were inserted into the data files and thus the out-of-control process was simulated. First, isolated deviations of  $1.5\sigma$ ;  $2\sigma$  and  $3\sigma$  were inserted. The isolated deviation was inserted into 30th, 5030th and 9930th repeating. Subsequently, a simulated persistent deviation of  $1.5\sigma$ ;  $2\sigma$  and  $3\sigma$  was also performed, and only for  $20 \times 5$  combination and selected types of distribution. The deviation occurred before it was signalled by a point outside the limit. Subsequently, "the process was intervened" and next subgroup was devoid of deviation. Then the deviation reappeared. Only the  $MRL(\delta)$  and  $x_{95}$  indicators were used to assess NPCC performance. For an out-of-control process, minimum values of performance indicators are required. The calculation of these indicators is based on  $RL(\delta)$ . This is determined as the number of points that are recorded in the control chart from the moment the change in the process occurred until the change was signaled in the form of a point out of control limit. (Smajdorová, 2019)

#### **4.1 Summary of simulation of the out-of-control process with isolated deviation**

The results showed that for the in-control process, NPCCs perform very well, but for the out-of-control process with an isolated deviation, their performance is surprisingly poor, especially for small process changes. We can say that as the size of the subgroup grows, the performance indicators improve, as Das (2008) confirms. Worse performance indicators results for the out-of-control process with isolated deviation may be due to the reason that non-parametric control chart perceive the isolated deviation as a random deviation against which they are robust. (Smajdorová, 2019)

#### **4.2 Evaluation of simulations with persistent deviation**

The analysis of the  $MRL(\delta)$  and  $x_{95}$  performance indicators showed that the persistent deviation is detected more quickly by NPCC than the isolated deviation. As already mentioned, isolated deviation can be perceived by NPCC as a random deviation. The persistent deviation is detected by NPCC very quickly. More subgroups were needed for the first discovery of the deviation, followed by "process intervention" and the next subgroup did not contain the deviation. Then the deviation reappeared. One, at most two, selections were needed to detect it. Further deviations were detected at the first subsequent selection. The results show that NP-EWMA is the most powerful, as with the isolated deviation. Other NPCCs that have good  $x_{95}$  results are NP-CUSUM and SSCC. (Smajdorová, 2019)

## **5 DESIGN OF THE METHODOLOGY OF THE NON-PARAMETRIC CONTROL CHARTS APPLICATION IN PRACTICE**

The aim of this part is to describe the methodology of application of non-parametric control charts in practice. The methodology described in this chapter is based on a review of available literature on the issue and on the results of simulations. Further, the individual steps of the methodology will be described.

**1. Preparatory phase:** This phase of SPC includes determination of the quality characteristic or process parameter, which we want to regulate, selection of the suitable control point, choice of the method of data collection and recording (sample size and the frequency of sampling.).

**2. Data collection and analysis:** This step is an important part of the SPC, because here we verify whether the basic data assumptions are met and therefore whether the classic Shewhart CC can be used, or whether the data assumptions are not met and it will be preferable to use one of the non-parametric control charts. Verification of data assumptions can be performed using various statistical tests or graphical methods. It is always advisable to combine multiple tests with a graphical method.

**3. Selection of suitable control chart:** If all data assumptions are met, the classic Shewhart CC can be applied. The method of selecting a suitable Shewhart CC, its construction and evaluation is described in detail in publications about SPC. The problem occurs when one of the data assumptions is not met. In that case, the use of the classic Shewhart CC could lead to misleading results and, at worst, a deterioration of the process. Therefore, the application of non-parametric control charts is a possible alternative for these cases.

**4. Evaluation of statistical process control:** As with the classic Shewhart control charts, for the non-parametric ones is valid that if all points are within the control limits, then the process can be considered in-control. However, if any of the points in the CC lies either below the lower control limit or above the upper control limit, it is a sign that the process is out-of-control. That is, the process is affected by an assignable cause of variability that needs to be identified, found its root cause, then removed and the statistical stability assessment performed again. Flowchart for application of non-parametric control charts into practice is shown in Fig. 4. (Smajdorová, 2019)

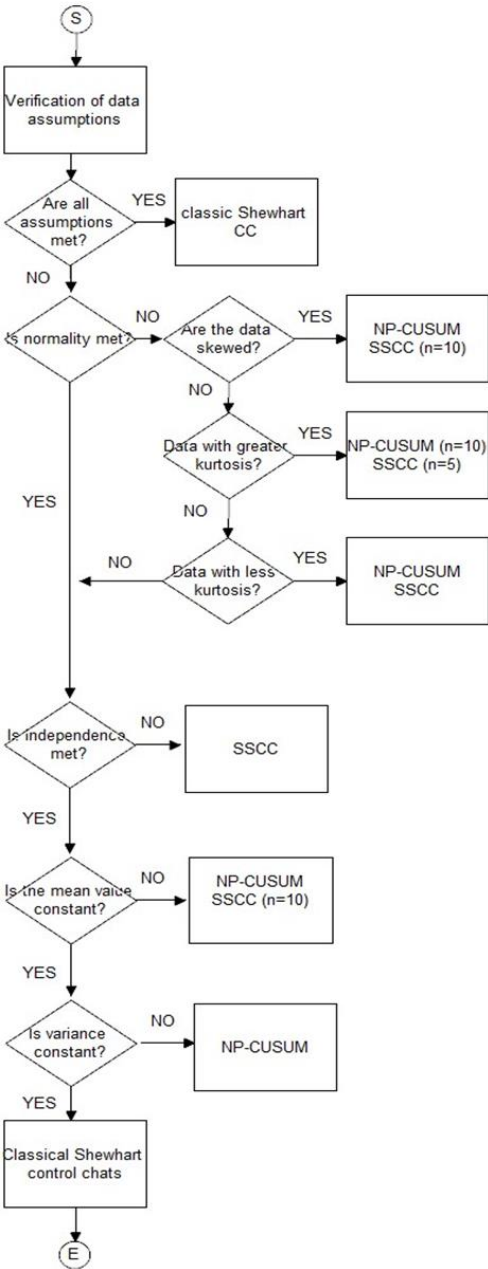

Fig. 4 – Flowchart for application of non-parametric control charts into practice. Source: own research



The proposed methodology was verified on real data from an organization operating in the automotive industry. The application of this methodology led to the improvement of the verified process and the entire system of statistical process control in the organization. (Smajdorová, 2019)

## 6 CONCLUSION

The issue of non-parametric SPC methods is well described in professional journals, but the transfer of these methods to practice is stuck. Based on the results of the simulation, it can be argued that different non-parametric control charts are differently effective for different types of data assumption violations. The research area of non-parametric SPC methods is very wide and offers many opportunities for further research, including the improvement of the SW support. Non-parametric SPC methods could become a permanent part of teaching statistical methods at universities as well as expert trainings. Non-parametric methods have also a big potential for the process monitoring in condition of Industry 4.0.

### Acknowledgment

This work was supported by the European Regional Development Fund in A Research Platform focused on Industry 4.0 and Robotics in the Ostrava Agglomeration project, CZ.02.1.01/0.0/0.0/17\_049/0008425 within the Operational Programme Research, Development and Education.

### References

- Adekeye, K. S., & Azubuike, P. I. (2012). Derivation of the Limits for Control Chart Using the Median Absolute Deviation for Monitoring Non-Normal Process. *Journal of Mathematics and Statistics*, 8(1), 37-41. doi: 10.3844/jmssp.2012.37.41
- Bakir, S. T. (2001). *Classification of Distribution-Free Quality Control Charts*. Paper presented at the Annual Meeting of the American Statistical Association 2001, Atlanta, USA. Retrieved from [https://www.researchgate.net/publication/259390239\\_CLASSIFICATION\\_OF\\_DISTRIBUTION-FREE\\_QUALITY\\_CONTROL\\_CHARTS](https://www.researchgate.net/publication/259390239_CLASSIFICATION_OF_DISTRIBUTION-FREE_QUALITY_CONTROL_CHARTS)
- Bakir, S. T., Prater, T., & Kiser, S. (2015). A Simple Nonparametric Quality Control Chart for Monitoring Students' GPAs. *SOP Transactions on Statistics and Analysis*, 2(1), 8-16. doi: 10.15764/STSA.2015.01002
- Chen, G. (1997). The Mean and Standard Deviation of the Run Length Distribution of  $\bar{X}$  Charts when Control Limits Are Estimated. *Statistica Sinica*, 7(3), 789-798. Retrieved from <https://www.jstor.org/stable/24306122>
- Das, N. (2008). A Note on the Efficiency of Nonparametric Control Chart for Monitoring Process Variability. *Economic Quality Control*, 23(1), 85-93. doi: 10.1515/EQC.2008.85
- Dempír, J., & Dohnal, L. (2005). Některé robustní postupy určení střední hodnoty a rozptýlení souboru výsledků a jejich použití. *Klinická biochemie a metabolismus*, 13(3), 139-144. Retrieved from <http://nts.prolekare.cz/cls/odkazy/kbm0503-139.pdf>
- Dhar, P. L. (2017). *Thermal System Design and Simulation*. Oxford: Elsevier/Academic Press.

- Chakraborti, S. (2007). Run Length Distribution and Percentiles: The Shewhart Chart with Unknown Parameters. *Quality Engineering*, 19(2), 119-127. doi: 10.1080/08982110701276653
- Jarošová, E., & Noskievičová, D. (2015). *Pokročilejší metody statistické regulace procesu*. Praha: Grada.
- Low, C. K., Khoo, M. B. C., Teoh, W. L., & Wu, Z. (2012). The Revised m-of-k Runs Rule Based on Median Run Length. *Journal Communications in Statistics*, 41(8), 1463-1477. doi: 10.1080/03610918.2011.606950
- Lu, S. L. (2015). An Extended Nonparametric Exponentially Weighted Moving Average Sign Control Chart. *Quality and Reliability Engineering International*, 31(1), 3-13. doi: 10.1002/qre.1673
- Murakami, H., & Matsuki, T. (2010). A nonparametric control chart based on the Mood statistic for dispersion. *The International Journal of Advanced Manufacturing Technology*, 49(5-8), 757-763. doi: 10.1007/s00170-009-2439-3
- Shannon, R. E. (1975). *Systems Simulation: The Art and Science*. New Jersey: Prentice-Hall.
- Smajdorová, T. (2019). *Využití neparametrických metod ve statistické regulaci procesů*. Ostrava: VSB – Technical University of Ostrava.
- Škapa, S. (2002). *Návrh řízení výrobního procesu ne-Gaussovského rozložení*. Brno: VUT.
- Wang, D., Zhang, L., & Xiong, Q. (2016). A non parametric CUSUM control chart based on the Mann-Whitney statistic. *Communications in Statistics - Theory and Methods*, 46(10), 4713-4725. doi: 10.1080/03610926.2015.1073314

## Contact information

### **Ing. Tereza Smajdorová, Ph.D.**

VŠB – Technical University of Ostrava, Faculty of Materials Science and Technology  
17. listopadu 15, 70833, Ostrava – Poruba, Czech Republic  
E-mail: tereza.smajdorova@vsb.cz  
ORCID: 0000-0002-3426-697X

### **prof. Ing. Darja Noskievičová, CSc.**

VŠB – Technical University of Ostrava, Faculty of Materials Science and Technology  
17. listopadu 15, 70833, Ostrava – Poruba, Czech Republic  
E-mail: darja.noskievicova@vsb.cz  
ORCID: 0000-0002-1154-712X

doi: 10.7441/dokbat.2019.092

# RE-LAYOUT OF WORKSHOP BASED ON MATERIAL AND PEOPLE FLOWS

*Vladimír Sojka, Petr Lepšík*

## **Abstract**

Many companies are trying to improve processes and workplaces. One of ways how to improve it could be re-layout of workshop. Effective re-layout should lead to improvement of flows in manufacturing. When improving efforts are focused only on material flows, result could not be the best global optimum. By blindly optimizing only material flows quality, another aspect of manufacturing, can decrease. For instance, with highly optimized material flow workers must walk longer distances, which means longer time they are doing an activity with no added value to a final product. This should lead us to design or re-design layouts with interest on both material and people flows. This paper deals with this problem and shows a possible way how to manage it, by use of analysis of walking intensity between particular places in workplace. This visualization method can show the most frequent paths and best places for middle area of new layout. Paper also includes a case study from packing hall where custom metal and glass parts are packed.

*Keywords: re-layout, material flow, people flow, lean, Spaghetti diagram, intensity of walks*

## **1 INTRODUCTION**

When a processes or workplaces are getting improved, it is possible that the most useful solution is complete re-layout of the workplace. There are many publications focusing on workplace improvement by re-layout for example: Krajčovič et al. (2019), Suhardini, Septiani & Fauziah (2017) or Kovács & Kot (2017). For this purpose, there are many tools. Spaghetti diagram is one of the most widely spread tools. Use of Spaghetti diagram for layout improvement can be seen in Briggs & Muthuswamy (2013) and Tanco et al. (2013).

Efforts in re-layout are mainly focused on material flows. They must be as short as possible and straight, without crossings. Material flow optimization is described for example: Bauer, Ganschar & Gerlach (2014), Nalusamy (2016) or Kovács (2019), with main focus on material throughput deals Johnson (2003). Other case could be a project focusing on employees, where efforts are to reduce walking distances. Use of Spaghetti diagram for workers' movement analysis describing Senderská, Mareš & Václav (2017).

Problem could occur if one flow is optimized the second one could be disadvantaged. For example, when material flow is shortened as possible. Parts are going straight and short distances, people can walk for longer distances than before. Or on the other hand when people flows are improved, material flows could be worsened.

That calls for method which can optimize re-layout efforts in both ways for material flows and for people flows. One of solutions could be use of the Spaghetti diagram with analysis of people's walk intensity between particular places in workshop.

Aim of this paper is to use the Spaghetti diagrams and intensity of walks analysis for optimization of re-layout efforts by focusing on both, material and people flows. Paper also includes a case study from packing hall.

## 2 THEORETICAL BACKGROUND

### 2.1 Spaghetti diagram

Spaghetti diagram is a method for visualization of object's movement in a system. Movement of material, parts or people can be described by this diagram. Flow are visualized by lines, which follow real movement of objects in the system. The system can be workshop, building or larger area, where objects are moving. Lines are drawn into a layout, different colours or types of lines are used for different flows. Spaghetti diagram reveals areas in processes or workshops where is unnecessary movement. New layout should have Spaghetti lines as short as possible and without too many crossings. (Kanaganayagam, Muthuswamy & Damoran, 2015).

## 3 METHODOLOGY

Material flows are easily analysed by the Spaghetti diagram. Flows of each material or part which is needed for the final product is drawn into the layout. For flows of people, Spaghetti diagram could not be the best tool. When there is a lot of paths in different directions, which is typical for custom production, Spaghetti diagram is after few moments of capturing very chaotic, and it is very hard to make decision based on it. In this situation the intensity of walks analysis can help to visualize where the most intensive flow of people is.

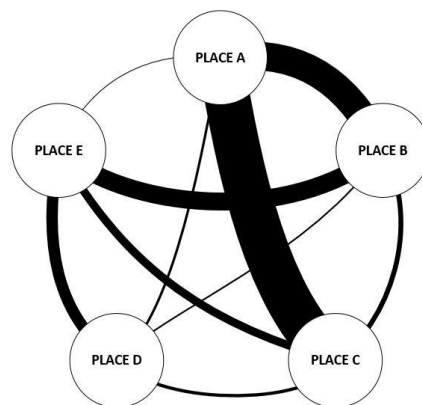

Fig. 1 – Analysis of walks intensity. Source: own research

Figure 1 shows how could look a visualization of walk intensity between places. Thickness of lines are in ratio of real number of walks between particular places. Between Place A and Place C there is obviously the most intensive flow, next are places A and B. That gives us a clear clue for designing of a new layout. Places A, C and B should be close together. Only small difference in length between these places have very big impact on overall worker's walking time. Capturing of data for this analysis is almost the same as for Spaghetti diagram, only instead of drawing lines, number of walks between particular places is counted. Graphic visualization must be made with the same ratio as real number of walks. This visualization also shows if there is a lot links from one place, this place should be placed somewhere at the centre of the layout, because there are lot of paths from other places.

New layout should be made with awareness of all information from material flows, captured by Spaghetti diagrams, and also from people flows. If only material flows are prioritized, places with high intensity of walk could be put far away from itself. Which means that workers would spend more time by walking. So material could be on the right place very fast but workers must walk around instead of creating value. Intensity of walk flow can be reduced by corrections. Workshop could be divided, or only few objects can be moved nearer to worker.

For final layout it is also obviously crucial to follow other necessary requirements of processes, machines, workshops and buildings.

### 3.1 Case study

A case study was done in company in Czech Republic. Company makes assemblies from glass and metal parts in custom production. Aim of the case study was re-layout of packing hall which was task from a bigger optimization project for the whole packing hall (Sojka, 2018). Because of custom production packing procedures are changing, it depends on type and dimensions of a part or assembly for packing. There are also many types of boxes and packing materials for each possible type of part. Capturing of data for material flow analysis was done by watching of all processes in packing hall. After gaining knowledge of all material flows Spaghetti diagram for material movement was made (Fig. 2).

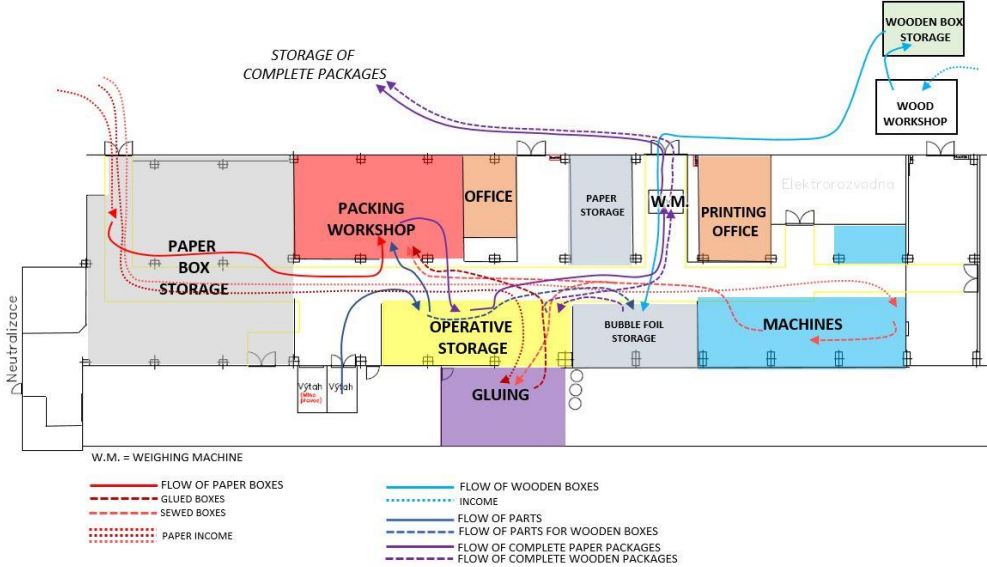

Fig. 2 – Material flows in packing hall - before. Source: own research

In the overall production optimization project the decision to tear down many inner walls was made. That allows to smoother flows of material trough packing hall. New layout based only on material flows was made (Fig.3).

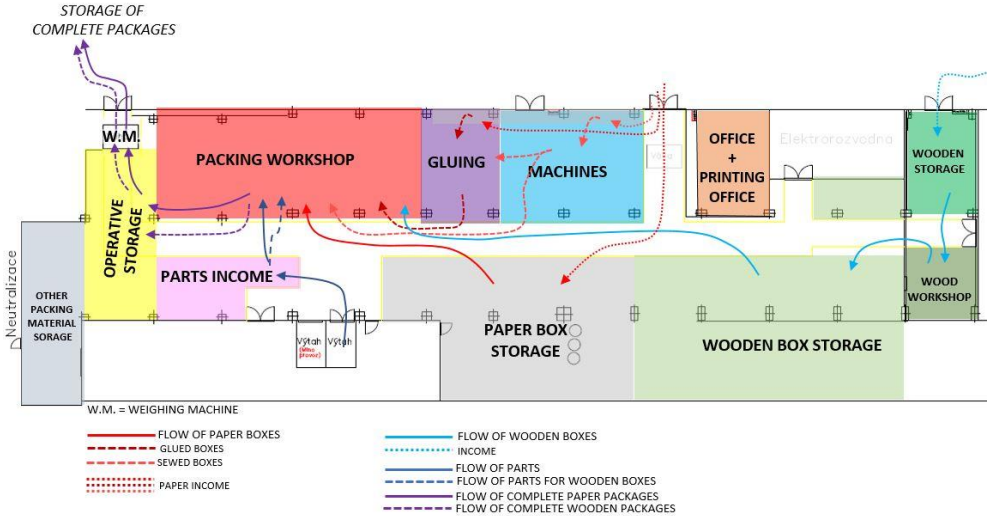

Fig. 3 – New material flows in packing hall – material flows priority. Source: own research

Main focus was to shorten the length of part's flow to a minimum. Output doors were moved to the left, because it is nearer to storage of complete packages. Wood workshop and storage of wooden boxes were moved into the building where packing is. Operative storage was divided into area for income parts and operative storage for outcome packages. Length of parts throughput was rapidly shortened. After that, a next measurement was made. Two measure days for technologist of packing and another two measure days for packer. In these measure day all activities of workers during the day were captured. From these data a number of walks between particular places were collected.

Next step was to visualize the intensity of walks between places. In Figure 4 the visualization of walks can be seen, the intensity is represented by thickness of lines between places.

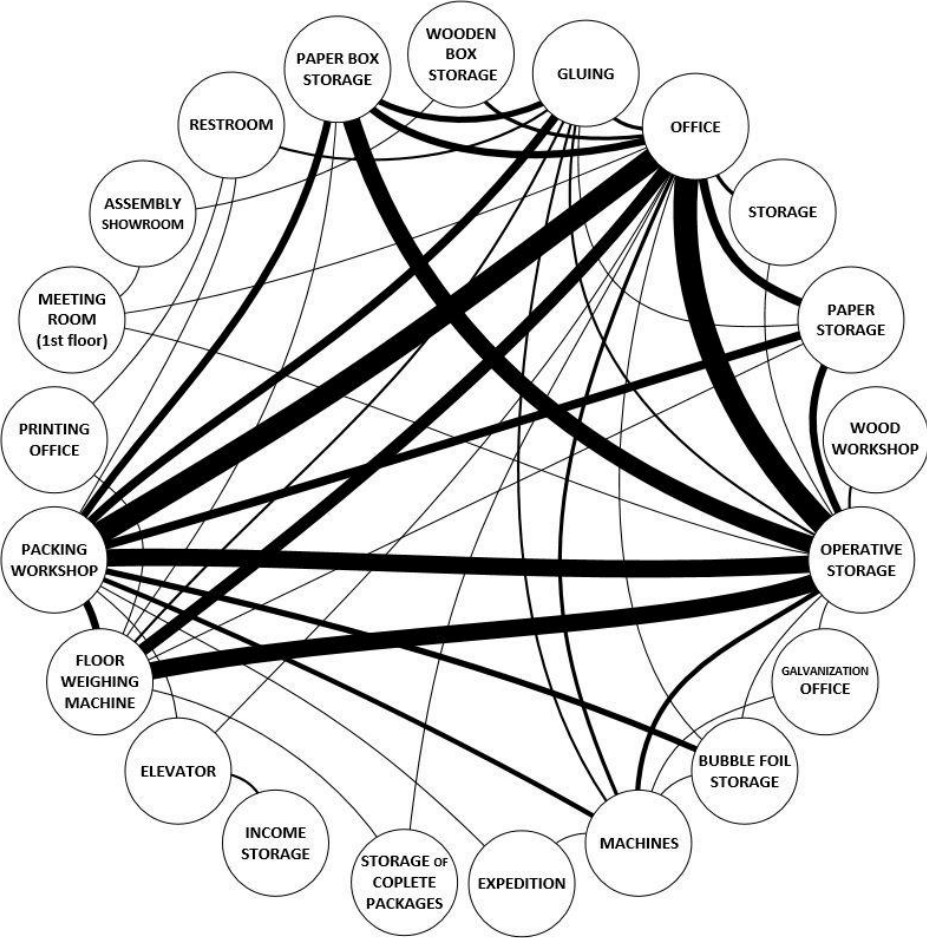

Fig. 4 – Intensity of walks visualization. Source: own research

From Figure 4 it is clear that the highest walk intensity is between office, operative storage and packing workshop. These three places should be as close together as possible. Because of the high number of links coming from these three places it is also good idea to put them somewhere in the middle of the layout. Weighing machine and paper box storage is also worth for mention. These two places should be placed thoughtfully.

This visualization leads to second variant for new layout where the main focus is not only to material flows but also on people flows. This second variant is shown in Figure 5.

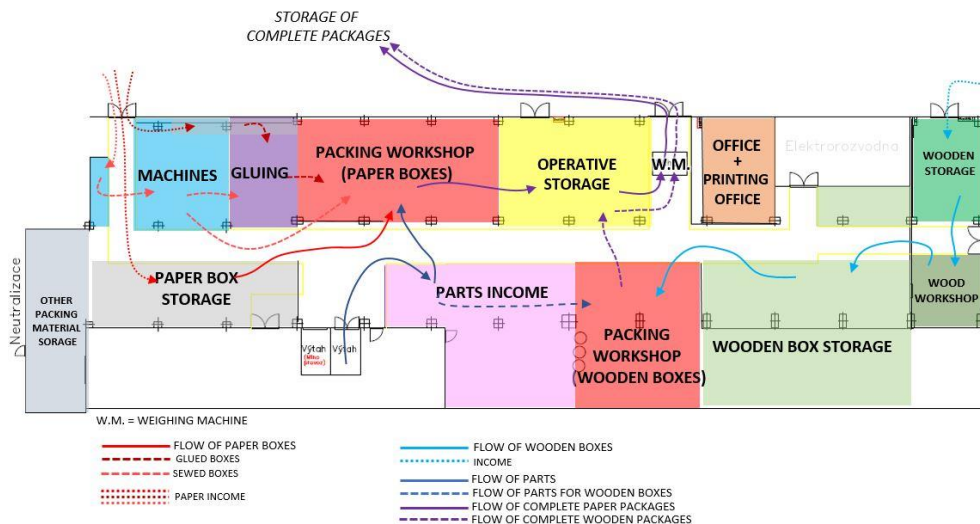

Fig. 5 – New material flows in packing hall – variant 2. Source: own research

In variant 2, office, operative storage and packing workshop are near together, and in centre of the whole hall. Workshop for packing was divided to two places where one is for packing into paper boxes and second is for packing into wooden boxes. All other material and most used paper boxes are stored in small batches at packing workshop, so number of walks to storages is also reduced.

#### 4 RESULTS

Two designs of new layout were compared. First comparison was focused on length of parts throughput through packing hall. Length of throughput is from elevator where input of parts for packing is, through packing hall to packing workshop where parts are packed into final packages, which goes outside on a loading platform. Comparison is shown in Table 1 below.

Tab. 1 – Comparison of parts throughput length. Source: own research

	Before	Variant 1	Variant 2
<b>Length of parts throughput</b>	82.6 m	33.7 m	47.7 m

From Table 1, it is seen that both new variants are much better than state before. Clearly the best opinion is variant 1 with shortest length of throughput. Which means that parts should go through packing hall in the fastest way.

Next comparison was made for length of most used paths between places in packing hall. The most used paths, which were based on Figure 4, are paths between: office – operative storage, office – packing workshop, operative storage – packing workshop, operative storage – weighing machine and operative storage – paper box storage. More described in Table 2.

Tab. 2 – Comparison of most used walking distances. Source: own research

Paths	Before	Variant 1	Variant 2	
Office – Operative storage	14.1 m	39.1 m	8.7 m	
Office – Packing workshop	19.6 m	28.2 m	23.9 m (paper boxes)	9.8 m (wooden boxes)
Operative storage – Packing workshop	8.7 m	1.5 m	1.5 m (paper boxes)	8.7 m (wooden boxes)
Operative storage – Weighing machine	17.4 m	1.5 m	1.5 m	
Operative storage – Paper box storage	18.5 m	28.2 m	23.9 m	
<b>SUM</b>	<b>78.3 m</b>	<b>98.5 m</b>	<b>59.5 m</b> (paper boxes)	<b>52.6 m</b> (wooden boxes)

It is seen, that Variant 1 which is the best in the way of material flow optimization, is even worse than the state before from the walking length point of view. On the other side Variant 2 is the best for walking reduction and for packing of parts into paper boxes or into wooden ones.

Final result is that Variant 2, where focus on both, material and people flows was used is the best. And it was recommended for realization. This approach is not the best solution in particular comparisons (material flow, people flow). But in overall it is the best time and length saving solution for whole workshop.

## 5 CONCLUSION

It was proved that for design of new layout or for re-layout of old ones, there is need to optimize both, material flows and people flows. Even if the material flow is optimized to the best level, it does not necessary mean that global optimum for all flows (material and people) is the best.

Problem with capturing of easy visualization of people flows was solved by analysis of intensity of walk between parts of layout.

This theoretical taught was proved by case study from packing hall for packing of custom parts from glass and metal in Czech Republic.

### Acknowledgments

This publication was written at the Technical University of Liberec as part of the project "Innovation of the products, equipment and processes in engineering practice" with the support of the Specific University Research Grant, as provided by the Ministry of Education, Youth and Sports of the Czech Republic in the year 2019.

### References

- Bauer, W., Ganschar, O., & Gerlach, S. (2014). Development of a Method for Visualization and Evaluation of Production Logistics in a Multi-Variant Production. *Procedia CIRP*, 17(2014), 481-486. doi: 10.1016/j.procir.2014.02.027
- Briggs, A., & Muthuswamy, S. (2013). Work Layout Improvement and Creation with Rise in Demand. In A. Krishnamurthy & W. K. V. Chan (Eds.), *Proceedings of the 2013 Industrial and Systems Engineering Research Conference*. Institute of Industrial and Systems Engineers, 2424-2432. Retrieved from <http://search.proquest.com/openview/64c0b82a4cbfcc24eb08fd07efbd40ee/1?pq-origsite=gscholar&cbl=51908>
- Johnson, D. J. (2003). A Framework for Reducing Manufacturing Throughput Time. *Journal of Manufacturing Systems*, 22(4), 283-298. doi: 10.1016/S0278-6125(03)80009-2
- Kanaganayagam, K., Muthuswamy, S., & Damoran, P. (2015). Lean Methodologies to Improve Assembly Line Efficiency: An Industrial Application. *International Journal of Industrial and Systems Engineering*, 20(1), 104-116. doi: 10.1504/IJISE.2015.069000
- Kovács, G., & Kot, S. (2017). Facility layout Redesign for Efficiency Improvement and Cost Reduction. *Journal of Applied Mathematics and Computational Mechanics*, 16(1), 63-74. doi: 10.17512/jamcm.2017.1.06



- Kovács, G. (2019). Layout design for efficiency improvement and cost reduction. *Bulletin of the Polish Academy of Sciences Technical Sciences*, 67(3), 547-555. doi: 10.24425/bpasts.2019.129653
- Krajčovič, M., Hančinský, V., Dulina, L., & Grznár, P. (2019). Use of Genetic Algorithm in Layout Design. *Acta logistica - International Scientific Journal about Logistics*, 6(2), 43-48. doi: 10.22306/al.v6i2.120
- Nallusamy, S. (2016). Productivity Enhancement in a Small Scale Manufacturing Unit through Proposed Line Balancing and Cellular Layout. *International Journal of Performability Engineering*, 12(6), 523-534. Retrieved from [https://www.researchgate.net/publication/309810539\\_Productivity\\_enhancement\\_in\\_a\\_small\\_scale\\_manufacturing\\_unit\\_through\\_proposed\\_line\\_balancing\\_and\\_cellular\\_layout](https://www.researchgate.net/publication/309810539_Productivity_enhancement_in_a_small_scale_manufacturing_unit_through_proposed_line_balancing_and_cellular_layout)
- Senderská, K., Mareš, A., Václav, Š. (2017). Spaghetti Diagram Application for Workers' Movement Analysis. *UPB Scientific Bulletin, Series D: Mechanical Engineering*, 79(1), 139-150. Retrieved from [https://www.scientificbulletin.upb.ro/rev\\_docs\\_arhiva/full5a2\\_608068.pdf](https://www.scientificbulletin.upb.ro/rev_docs_arhiva/full5a2_608068.pdf)
- Sojka, V. (2018). *Návrh systému balících pracovišť*. Liberec: Technical University of Liberec.
- Suhardini, D., Septiani, W., & Fauziah, S. (2017). Design and Simulation Plant Layout Using Systematic Layout Planning. *IOP Conference Series: Materials Science and Engineering*, 277(1), 1-8. doi: 10.1088/1757-899X/277/1/012051
- Tanco, M., Santos, J., Rodriguez, J. L., & Reich, J. (2013). Applying lean techniques to nougat fabrication: a seasonal case study. *International Journal of Advanced Manufacturing Technologies*, 68(5-8), 1639-1654. doi: 10.1007/s00170-013-4960-7

## Contact information

### Ing. Vladimír Sojka

Technical University of Liberec, Faculty of Mechanical Engineering  
Studentská 1402/2, 46117, Liberec, Czech Republic  
E-mail: vladimir.sojka@tul.cz  
ORCID: 0000-0001-7295-8160

### doc. Ing. Petr Lepšík, Ph.D.

Technical University of Liberec, Faculty of Mechanical Engineering  
Studentská 1402/2, 46117, Liberec, Czech Republic  
E-mail: petr.lepsik@tul.cz  
ORCID: 0000-0003-1900-7264

doi: 10.7441/dokbat.2019.093

# **FAMILY BUSINESS OWNERS PLAN OVER THE LONG TERM: FRAMEWORK OF RESEARCH AND PRELIMINARY RESULTS COVERING THE CZECH REPUBLIC**

*Pavla Srbová*

## **Abstract**

A family business is characterized by a combination of ownership, management, and family, in other words, linking the business and family life. Family businesses are the predominant form of business all over the world and have a significant impact on economic growth, employment or social development. The literary research shows that what distinguishes the family business from non-family one are unique characteristics such as long-term planning. The validity of these specifics will be verified by using research questions. The article deals with a family business with a focus on its specifics: long-term planning and generation exchange and presents the preliminary results of 20 family businesses from the Czech Republic. The respondents of the research are the owners of private Czech family businesses. The data presented in this paper are analysed by using descriptive statistics, namely frequency and percentage and are collected from the beginning of August until the end of September 2019. Based on preliminary research it was found that 85% of the surveyed companies make plans (of which 50 % form strategic plans and 15 % form plan for 3 years). 85% of analysed companies plan to hand over the business to the next generation.

*Keywords: family business, preliminary research, Czech Republic, definition of family business, long term planning*

## **1 INTRODUCTION**

Family businesses are the predominant form of business all over the world and have a significant impact on economic growth, employment or social development. They are characterized by a combination of business and family life.

J. Casado states that family businesses are an indisputable asset to sustainability of European economy. However, economic policy, mainly based on statistical data, reflects them poorly. Policymakers should consider the ownership structure of these companies and the contribution of human factor to the business. (Botero et al., 2015)

Insufficient attention has been paid to the family business until recently. The situation has changed over the last 30 years and much attention worldwide has been devoted to the research of family business. The problem that remains is the existence of many definitions of family businesses, which does not allow for objective comparison of the research carried out. Earlier this year (2019), the Czech Republic approved the definition of family business. The definition is given below in the theoretical background.

In the Czech Republic, as in the other post-communist countries, continuous existence of the family business was interrupted. Most contemporary family businesses were established after the revolution. Nowadays, the first-generation exchange progress in these companies. Therefore, there is a growing interest in this issue. One of the most difficult organizational changes that any successful family business must face is the succession process (Rodríguez & Tàpies, 2010). Paying early attention to this process and developing a succession plan is important because of its inevitability (Rodríguez & Tàpies, 2010). The complexity of the

succession process leads to a high number of failed handovers (Matser & Lievens, 2011). According to Ward (2011), only 13% of businesses remain family-owned in the third generation, while for the second generation, about two-thirds of the companies remain family-owned. Insufficient planning is one of the main reasons for the failure of a business transfer because when planning the participants realize the complexity of the succession process (Matser & Lievens, 2011). Only 52% of Czech family business owners are interested in a generational exchange, mainly asking for advice from their friends (n=331) (Survey of AMSP CZ, 2018).

One way to facilitate handover is to determine the value of a family business. The value of a family business should include not only financial but also non-financial aspects specific to this type of business (Astrachan & Jaskiewicz, 2008). These specifics form socioemotional wealth (SEW) of family business. One of these aspects is long term planning. Long-term planning with a view to pass the family business to future generation serves as motivation to develop the company for family business owners. Zellweger et al. (2012) found out that transgenerational control intention has a consistently positive impact on the perceived acceptable selling price. Miller & Breton-Miller (2006) claimed that the family's intention to pass the business to subsequent generations is associated with enhancing financial performance.

The structure of the article is as follows. The first part of the article is devoted to the theoretical background of family business such as the definition of family business and the long-term planning which is one of family business specifics. The second part is devoted to the methodology of ongoing research. The last part of the paper presents the evaluation of preliminary results of the research.

## **2 THEORETICAL BACKGROUND**

Family businesses are typically characterized by a high level of social responsibility towards their employees, actively and responsibly managing resources. They usually consider the economic future of the business in terms of sustainability in the long term, thereby significantly contributing to the life of local communities and to Europe's competitiveness and to create and maintain quality jobs. (European Parliament, 2015)

Williams (2018) is the author of the most commonly used non-financial performance indicators based on the analysis of publications.

The SEW concept was first formally introduced by Gomez-Mejia et al. in 2007 (Cennamo et al., 2012). Gómez-Mejía et al. (2007) characterized socioemotional wealth (SEW) as a noneconomic and emotional value associated with a family business. SEW is influenced by satisfying family needs such as identity, the ability to exercise family influence, and the perpetuation of the family dynasty. The decline in SEW is seen as a significant loss for a family business. To avoid this loss, businesses are willing to take a greater risk, even one that may threaten the very survival of the business. Zellweger et al. (2012) found out that intention for transgenerational control has a consistently positive impact on the perceived acceptable selling price. The selling price of a business is usually lower for a buyer within the family than for an outsider because the family wants to be compensated for the loss of SEW.

### **2.1 Definition of Family Business**

The family businesses have been a matter of concern to the European Union (EU) and the individual member states in the last years. The EU has developed its own proposal for a definition of family business, which should help facilitate the analysis of these companies (EHSV, 2016). As reported by Sharma (2004), many definitions of family business are known,

but none of them is generally accepted. Experts use different factors to distinguish these businesses from non-family ones, such as percentage ownership, strategic control, multi-generation involvement, and the intention of owners to keep a business in the family (succession planning) (Astrachan & Shanker, 2003).

An overview of definitions from 1960 to May 2017 was compiled by a team of authors Diaz-Moriana et al. (2019) in the article called *Defining Family Business: A Closer Look at Definitive Heterogeneity*.

Defining family businesses for examining the differences between family businesses and non-family ones is important also according to Czech authors Hnilica & Machek (2015). Researchers have concluded, given the unique legal background in different countries, universal definition for all of them is not desirable. Despite this recommendation, any definition of family business should consider three factors (Hnilica & Machek, 2015): (a) family's share of business ownership, (b) involvement of family members in company management, or (c) membership in the executive or supervisory board to maintain control over the company.

In the Czech Republic, the definition of family business was approved on 13 May 2019 (AMSP CZ). The Association of Small and Medium-sized Enterprises and Crafts of the Czech Republic (AMSP CZ) proposed the basis of the definition reflecting the standard formulated by the European Family Businesses and Czech and foreign professional resources. Since its adoption, the definition is binding on the government members and the representatives of the state administration. The aim was to define the family business so that the definition is applicable to everyone, to create the definition suitable for stakeholders and based on it to make measures specific to this type of business (e.g. to support them). The new definition deals with family businesses and family crafts. To summarize it, to be considered as a family business corporation it is important that the family owners have majority control over the company and at least one member of the family is its company agent. As a family craft is considered the business in which are included at least two family members by their work or property (HK ČR, 2018).

## **2.2 Long term planning in a family business**

Miller, D., & Le Breton-Miller (2006) defined long-term orientations as priorities, goals, and concrete investments that come to fruition typically 5 years or more. The long-term orientation of any firm is a concept that includes many aspects, such as brand building, innovation, and human resource management (Block, 2009). Family businesses are considered to be more long-term oriented than non-family ones (Block, 2009).

Based on a literature review, Berrone et al. (2012) identified five categories of SEW. One of these categories is the renewal of family bonds to the firm through dynastic succession. Family business is characterized by long-term planning and the intention to pass the business to future generations is one of the key aspects of SEW. Long-term planning affects corporate decision-making processes, the company is not an easy-to-sell asset but symbolizes family heritage and tradition. Berrone et al. (2012) considered important to deal with business transfer to the next generation and unwillingness to consider selling the family business, the importance of continuing the family legacy and tradition, and evaluation of investment because family owners are less likely to evaluate their investment on a short-term basis.

Block (2009) considered the benefits of long-term orientated family companies as more effective monitoring because family is known in the society, strong family identity and plan to transfer it to the next generation, emotional attachment of family owners to their company and lower information asymmetry between owners and management. Dutch research showed (Matser & Lievens, 2011) that strong attached of owner-manager to the company can also cause

problems because the original owner is not able to leave the company and give responsibility to the successors.

Succession planning is one of the key business research and is important for business continuity. Strong motivation for continuity and strong family harmony are generally seen as the ideal motives for business succession by literature. (Gilding et al, 2015).

Long term survival of a firm is one of the business-centered goals. Between family-centered non-financial goals belong family ownership sustainability, which refers to the long term goals; sustained family ownership, control and influence; and intra-familial succession and employment of family members in the family business. (Binz et al., 2017)

Many family businesses transfers are unsuccessful, in part, this is because personal and emotional factors determine who the next leader will be. The problematic succession is caused by an inappropriate relationship between an organization's past and its present. The issues may arise when the new leader is too conservative (too attached on the past), or too rebellious (rejecting the past), or too unsure one (an incongruous blending of past and present). (Miller et al., 2003)

Mazzola et al. (2008) state the major benefits of the strategic planning process. The strategic planning process can play an important role in the development of next-generation family managers after they join the firm. The involvement of the next generation in developing strategic plan content can help the firm to receive benefits: educational and relational. Authors suggest that next-generation benefits are increasing in the presence of certain conditions: 1) the adoption of a formal and broad strategic planning process, 2) the existence of either a business or an ownership purpose behind the realization of strategic plan, and 3) the next generation's involvement in the process.

### **3 RESEARCH**

#### **3.1 Hypotheses and research questions to verify them**

Based on the theoretical knowledge, the hypothesis was formulated and its validity is verified by research questions whose respondents are family business owners. Literary research leads to hypothesize the following: Family business owners plan over the long term with the aim to hand over their business to the future generation. The following research questions were formulated:

**RQ1:** Do you have clear intentions regarding the future development of your business?

Options: A) we create strategic plans / B) we create a three-year outlook / C) we have an annual plan / D) we plan in the short term / E) we don't have a plan

**RQ2:** Do you plan to hand over the family business to the family members in the future?

Options: A) Yes, I already know the name of successor / B) Yes, but I have no successor selected yet / C) No, I don't plan to hand over the business to family members

**RQ3:** Are you already preparing successor to take over the business? (sub-question if the answer to Q2 is "Yes, I already know the name of successor")

Options: A) Yes / B) No

**RQ4:** If you are not preparing a family member to take over the business, choose one of following options: (sub-question if the answer to Q2 is "No, I don't plan to hand over the business to family members")

Options: A) we plan to hand over the company to one of the employees / B) we plan to sell the company to an unknown buyer so far / C) we plan to sell the company and we're already looking for a buyer / D) we plan to sell the company to a known buyer / E) write other options

**RQ5:** Do you plan to continue working in the company after the handover?

Options: A) Yes / B) No

### 3.2 Data collection and analysis

The data are collected via face-to-face interviews, phone interviews or electronic communications. The respondents of the research are the owners of family businesses in the Czech Republic. The data are collected in the family companies following selected criteria (see below). The research includes private family businesses that meet the newly approved definition of family business in the Czech Republic. Another criterion is the size, a family business from 10 to 250 employees can be part of the research. These undertakings belong to the category of small and medium-sized enterprises (SMEs) because most family businesses are SMEs (European Parliament, 2015).

Given the non-existent family business database, the research does not obtain a random sample but a sample survey. This may lead to inaccuracies, but there is no more precise way to get the sample in the current situation where family businesses are not registered by the statistical office. For example, Czech authors Hnilica & Machek (2015) compiled a database by using a developed algorithm that searched for family businesses by surname matching, but this excludes, among other things, companies where family members have different surnames.

This paper presents the preliminary results of ongoing research. The data presented in this paper is analyzed by using descriptive statistics, namely frequency and percentage and are collected from the beginning of August until the end of September 2019.

## 4 PRELIMINARY RESULTS

This part of the article presents the results of the ongoing research. The research has been carried out so far in 20 companies, of which 60% belong to the manufacturing industry (Table 1).

Tab. 1 – Family businesses according to NACE code. Source: own research

NACE code	Sum
C - manufacturing	12
F - construction	1
G - wholesale and retail trade	2
I - accommodation and food service activities	1
N - administrative and support service activities	2
P - education	1
S - other service activities	1

The answers to the research questions are given in Table 2.

Tab. 2 – Preliminary results of the research. Source: own research

	RQ1	RQ1 [%]	RQ2	RQ2 [%]	RQ3	RQ3 [%]	RQ4	RQ4 [%]	RQ5	RQ5 [%]
<b>A</b>	10	50	9	45	8	40	0	0	18	90
<b>B</b>	3	15	8	40	1	5	0	0	2	10
<b>C</b>	4	20	3	15			1	5		
<b>D</b>	2	10					0	0		
<b>E</b>	1	5					2	10		
<b>Sum</b>	<b>20</b>	<b>100</b>	<b>20</b>	<b>100</b>	<b>9</b>	<b>45</b>	<b>3</b>	<b>15</b>	<b>20</b>	<b>100</b>

Based on the research questions, it was found that 85% of the surveyed companies make plans. From this preliminary research, it can already be ascertained that a large proportion of family businesses forms strategic plans (50%) or plan for 3 years (15%).

The author focused also on the plans for the future of the companies. 85% of companies are to hand over to the next generation. 9 owners stated they already know the successor and only one of them is not preparing him/her for the takeover (the owner has a small child). In case of 3 businesses the owners do not plan to hand over the business to family members. Their future plans include: the sale when the buyer is already known; owners do not currently deal with the future handover of the business; owners have no vision yet. Only one of the surveyed owners said he/she plans to sell the company.

## 5 DISCUSSION AND CONCLUSION

The article deals with private family firms from the Czech Republic. Most Czech family businesses were founded after the revolution and their owners are now challenging the succession process which is one of the most difficult changes that every company must face.

The literary research showed that family businesses are characterized by long-term planning and the intention to pass the business to future generations (Block, 2009; Berrone et al., 2012; Binz et al., 2017). Based on the preliminary results, we can say that most family businesses form a business plan. One-half of the analysed companies (10 companies) prepared a strategic plan. The majority of family business owners plan to hand the business over to the next generation, but the origin owners still plan to continue working in the company as an independent consultants or members of the board of directors or the supervisory board. This fact may undermine the effective functioning of the enterprise (Matser & Lievens, 2011). According to the preliminary research presented in this paper, we can confirm that most of the Czech family business owners plan over the long term, they plan to keep the business in the family and are actively preparing their successors for taking over.

### Acknowledgment

The author is grateful to the Internal Grant Agency of University No. FP-S-18-5234 “Prediction models in finance: analysis of factors and predictions of bankruptcy, company performance and value” for the financial support while carrying out this research

### References

- AMSP CZ. (2018). Výroční průzkum k trendům rodinného podnikání. *Asociace malých a středních podniků a živnostníků ČR*. Retrieved from <https://www.businessinfo.cz/app/content/files/dokumenty/Pruzkum-amp-rodinne-2018-firmy.pdf>
- AMSP CZ. (2019). Rodinné firmy překonaly další vrchol k podpoře českých podnikatelů. *Asociace malých a středních podniků a živnostníků ČR*. Retrieved from <http://amp.cz/rodinne-firmy-prekonaly-dalsi-vrchol-k-podpore-ceskych-podnikatelu/>
- Astrachan, J. H., & Jaskiewicz, P. (2008). Emotional returns and emotional costs in privately held family businesses: Advancing traditional business valuation. *Family Business Review*, 21(2), 139-149. doi: 10.1111/j.1741-6248.2008.00115.x

- Astrachan, J. H., & Shanker, M. C. (2003). Family businesses' contribution to the US economy: A closer look. *Family business review*, 16(3), 211-219. doi: 10.1177/08944865030160030601
- Berrone, P., C. Cruz & L. R. Gomez-Mejia (2012). Socioemotional Wealth in Family Firms. *Family Business Review*, 25(3), 258-279. doi: 10.1177/0894486511435355
- Binz, C. A., Ferguson, K. E., Pieper, T. M., & Astrachan, J. H. (2017). Family business goals, corporate citizenship behavior and firm performance: disentangling the connections. *International Journal of Management and Enterprise Development*, 16(1-2), 34-56. doi: 10.1504/IJMED.2017.082549
- Block, J. (2009). Long-term orientation of firms. In Long-term Orientation of Family Firms. Wiesbaden: Gabler.
- Botero, I. C., C. Cruz, A. De Massis & M. Nordqvist (2015). Family business research in the European context. *European Journal of International Management*, 9(2), 139-159. doi: 10.1504/EJIM.2015.067858.
- Cennamo, C., Berrone, P., Cruz, C., & Gomez-Mejia, L. R. (2012). Socioemotional wealth and proactive stakeholder engagement: Why family-controlled firms care more about their stakeholders. *Entrepreneurship Theory and Practice*, 36(6), 1153-1173. doi: 10.1111/j.1540-6520.2012.00543.x
- Diaz-Moriana, V., Hogan, T., Clinton, E., & Brophy, M. (2019). Defining family business: A closer look at definitional heterogeneity. In The Palgrave handbook of heterogeneity among family firms. London: Palgrave Macmillan.
- EHSV. (2016). Stanovisko Evropského hospodářského a sociálního výboru k tématu Rodinné podniky v Evropě jako zdroj budoucího růstu a lepších pracovních míst. *Úřední věstník Evropské unie, svazek 59*. Retrieved from <https://eur-lex.europa.eu/legal-content/CS/TXT/?uri=OJ:C:2016:013:TOC>
- European Parliament. (2015). European Parliament resolution of 8 September 2015 on family businesses in Europe (2014/2210(INI)). Retrieved from <http://www.europarl.europa.eu/sides/getDoc.do?pubRef=-//EP//TEXT+TA+P8-TA-2015-0290+0+DOC+XML+V0//CS>
- Gilding, M., Gregory, S., & Cosson, B. (2015). Motives and outcomes in family business succession planning. *Entrepreneurship Theory and Practice*, 39(2), 299-312. doi: 10.1111/etap.12040
- Gómez-Mejía, L. R., Haynes, K. T., Núñez-Nickel, M., Jacobson, K. J., & Moyano-Fuentes, J. (2007). Socioemotional wealth and business risks in family-controlled firms: Evidence from Spanish olive oil mills. *Administrative science quarterly*, 52(1), 106-137. doi: 10.2189/asqu.52.1.106
- HK ČR. (2018). Vymezení rodinného podniku v České republice 140/18. Hospodářská komora České republiky. Retrieved from <https://www.komora.cz/legislation/140-18-vymezeni-rodinneho-podniku-v-ceske-republice-t-31-12-2018/>
- Hnilica, J. & O. Machek (2015). Toward a Measurable Definition of Family Business: Surname Matching and its Application in the Czech Republic. *International Advances in Economic Research*, 21(1), 119-120. doi: 10.1007/s11294-014-9487-7
- Matser I. & J. Lievens (2011). The succession scorecard, a tool to assist family business's trans-generational continuity. *International Journal of Entrepreneurial Venturing*, 3, 101-124. doi: 10.1504/IJEV.2011.039336



- Mazzola, P., Marchisio, G., & Astrachan, J. (2008). Strategic planning in family business: A powerful developmental tool for the next generation. *Family Business Review*, 21(3), 239-258. doi: 10.1177/08944865080210030106
- Miller, D., Steier, L., & Le Breton-Miller, I. (2003). Lost in time: Intergenerational succession, change, and failure in family business. *Journal of Business Venturing*, 18(4), 513-531. doi: 10.1016/S0883-9026(03)00058-2
- Miller, D., & Le Breton-Miller, I. (2006). Family governance and firm performance: Agency, stewardship, and capabilities. *Family business review*, 19(1), 73-87. doi: 10.1111/j.1741-6248.2006.00063.x
- Sharma, P. (2004). An overview of the field of family business studies: Current status and directions for the future. *Family business review*, 17(1), 1-36. doi: 10.1111/j.1741-6248.2004.00001.x
- Trevinyo-Rodríguez, R. N., & Tàpies, J. (2010). Effective knowledge transfer in family business. *IESE Business School Working Paper No. 865*. doi: 10.2139/ssrn.1673904
- Ward, J. L. (2011). *Keeping the Family Business Healthy*. London: Palgrave Macmillan.
- Williams R. I. (2018). Measuring family business performance: research trends and suggestions. *Journal of Family Business Management*, 8(2), 146-168, doi: 10.1108/JFBM-12-2017-0047
- Zellweger, T. M., Kellermanns, F. W., Chrisman, J. J., & Chua, J. H. (2012). Family control and family firm valuation by family CEOs: The importance of intentions for transgenerational control. *Organization Science*, 23(3), 851-868. doi: 10.1287/orsc.1110.0665

### Contact information

#### Ing. Pavla Srbová

Brno University of Technology, Faculty of Business and Management  
Kolejní 2906/4, 61200 Brno, Czech Republic  
E-mail: xpsrbov00@vutbr.cz  
ORCID: 0000-0003-4076-9829

doi: 10.7441/dokbat.2019.094

# A STRUCTURED REVIEW OF THE SIX SIGMA BELT SYSTEM

*Roland Stankalla, Felicita Chromjaková*

## **Abstract**

The Six Sigma methodology creates many possibilities for a radical improvement of process and product quality. Organizations that are embarking on the implementation of Six Sigma improvement initiatives need to overcome substantial barriers to ensure the effectiveness of the implemented approaches. In many cases, the implementation of improvement initiatives involves a significant investment in the establishment of a supporting infrastructure and training for the improvement initiatives. One of the most critical success factors for the implementation of Six Sigma is a strong organizational infrastructure led by different Six Sigma belts. Thus, the aim of the article is to provide a comprehensive overview of the current state of research regarding the Six Sigma belt system. A total of 62 journal papers about the Six Sigma belt system published during the period from 2000 to 2016 were selected for the analysis. The analysis reveals that the research regarding the Six Sigma belt system has so far been focused primarily on large manufacturing enterprises. The Six Sigma belt system has not been yet adequately studied within the context of smaller companies. Thus, the field on the application of Six Sigma in the small and medium enterprises provides valuable research opportunities. Furthermore, only 15 out of the 62 articles focus exclusively on the examination of the SS belt system rather than exploring general application of the Six Sigma methodology. However, these research papers only focused on Black Belts or Green Belts while neither the Master Black Belt nor Yellow Belt was a high priority in these studies.

*Keywords: Six Sigma, Belt system, Master Black Belt, Black Belt, Green Belt, Yellow Belt*

## **1 INTRODUCTION**

Six Sigma (SS) is a disciplined and data-driven business improvement methodology that was developed to enhance the quality of processes with the objective of establishing an almost zero-defect quality strategy, thereby increasing customer satisfaction as well as improving financial results (Pyzdek, 2003). In recent years, various authors have criticized SS as "nothing but an old wine in a new bottle" since the methods originality seems to be under the Total Quality Management (TQM) umbrella (Kumar et al. 2008). However, there are some key aspects differentiating SS from TQM and other quality initiatives significantly as for example to follow structured methodologies (DMAIC and DFSS) during process improvements with focus on financial results, the use of specific metrics or the hierarchy of improvement specialists (Schroeder et al. 2008; Zu et al. 2008). This article explores the latter aspect of SS implementation, since the hierarchy of improvement specialists is a distinguishing feature of SS as compared to other improvement approaches.

In order to define hierarchy and career paths, SS borrows its terminology from the world of martial arts (Antony et al. 2005). Professionals trained in SS are distinguished by a colour of their belts; thus, belt system is an important ingredient of SS. Within this belt system ranks are determined based on their expertise, similar to karate students (Richardson, 2007). SS recognizes four classifications of trained professionals: Master Black Belt (MBB), Black Belt (BB), Green Belt (GB) and Yellow Belt (YB). For each rank, intensive differentiated training are designed in terms of knowledge and skills in statistical methods, project management,

process design, problem-solving techniques, leadership skills and other managerial skills (Pyzdek, 2003).

The literature is highlighting an extensive and massive organizational infrastructure as well as a strong training approach as one of the most important critical success factors for the implementation of SS in any organization (Timans et al. 2012; Douglas et al. 2015; Laux et al. 2015a and b). For this reason, the purpose of the proposed article is the classification of the literature published on the SS belt system with the goal to provide a comprehensive review of these studies. Based on the analysis, trends as well as future research proposals are presented. To achieve the proposed objectives, this research paper is divided into five chapters. After the introduction part in chapter 1, the theoretical fundamentals of SS (chapter 2), followed by a detailed overview of the research framework (chapter 3) are discussed. Chapter 4 presents the results and findings of the research. Finally, in chapter 5, the conclusion and future research proposals are presented.

## 2 THEORETICAL FUNDAMENTALS

Bill Smith from Motorola/USA developed SS during the mid-1980s. Based on the ideas of statistical process control, Motorola defined “Six Sigma” as 3.4 defects per million opportunities in a given production process. Sigma ( $\sigma$ ) is used to represent the variation (standard deviation) of a process mean. “Six” means that the distance between the mean and the critical tolerance limits shall be 6 standard deviations constantly (Arnheiter and Maleyeff, 2005; Pyzdek, 2003). Furthermore, SS is also being widely recognized as an effective leadership development tool. After 1995, SS was enhanced by General Electric as a business strategy used to improve business profitability. It was initially applied in the manufacturing sector but has then spanned over service, financial, healthcare and public sectors (Coronado and Antony, 2002). In 2003, LSS was established as part of the evolution of SS. It is the combination of Lean Management and SS which are the most popular business strategies for enabling continuous improvement and improved bottom-line results (Albliwi et al. 2015). This combination is achieved by merging tools and principles to overcome the weaknesses while bringing out the advantages of both programs. Lean focuses on removing all types of waste from the process (the efficiency issue) while SS concentrates on controlling the process statistically and reducing variation from the process (the effectiveness issue). The phrase “Lean Six Sigma” is therefore used to describe the integration of both these approaches into a comprehensive management system (Arnheiter and Maleyeff, 2005).

To produce the expected results, organizational roles and responsibilities that lead, deploy and implement SS must be clearly defined and aligned. As already mentioned, SS creates a hierarchy of process specialists which is also known as the belt system or the belt hierarchy. It consists of four main levels. Table 1 presents the minimum competencies of the SS belt roles according to the International Standard for SS, BS ISO 13053-1 (BSI, 2011).

Tab. 1 – Competencies for Six Sigma personnel. Source: British Standards Institute 2011

Competency/Skills	Master Black Belt	Black Belt	Green Belt	Yellow Belt
<b>Practical problem solving skills</b>	Highest level of availability	Highest level of availability	Highest level of availability	Basic competence
<b>Six Sigma tools knowledge</b>	Highest level of availability	Highest level of availability	Proficient user	Proficient user
<b>Statistical skills</b>	Highest level of availability	Proficient user	Basic competence	Skill not needed

Individuals at the highest level of expertise in the SS methodology carry the title of “Master Black Belt” (MBB). They are certified experts who lead the SS methodology implementation, develop training materials and teach, coach and mentor the lower-level BBs and GBs. MBBs undergo BB training, approximately four weeks of SS training over a four-month period, plus two weeks of additional training on mentoring SS projects (Montgomery and Woodall, 2008). BBs typically work on implementing and leading strategic, large, high-impact process improvement projects with the DMAIC methodology that might take 4-6 months to complete (Montgomery and Woodall, 2008; Coronado and Antony, 2002). They fall in the middle of the “Belt Hierarchy” and are the linkage between GBs and MBBs. Consequently, they are the driving force and play a critical role in the organization (Black and McGlashan, 2006). The importance of the BB level has been highlighted in many published articles and textbooks. Training to become a BB includes intensive rigorous training in analytical tools and their application for four weeks and is in most cases combined with a project or exam (Montgomery and Woodall, 2008). It is generally recognized that it is more effective to have full-time MBB and BB positions, meaning that 100% of their time and energy is dedicated to SS endeavours within the company. GBs are experts who integrate SS into their daily job duties and have been trained often 1 or 2 weeks within a two-month period in the SS DMAIC (Define – Measure – Analyse – Improve – Control) problem-solving methodology as well as in basic statistical tools. Additionally, GBs should complete their education with a project (Montgomery and Woodall, 2008). Since the projects are running along their other job responsibilities, GBs typically work part-time for SS projects (Coronado and Antony, 2002; Montgomery and Woodall, 2008) or shall spend at least 30 percent of their time working toward SS initiative projects (Aboelmegeed, 2010). The specialized training and education on statistical methods and other quality tools equip BBs and GBs to function as team leaders and technical problem solvers (Montgomery and Woodall, 2008). Due to the growth of SS application coupled with the proliferation of consultancy and training companies, it was found that it is equally important to have a large group of employees trained in basic SS tools in addition to trained mentors. The SS specialists that acquired this basic training level are named “Yellow Belts” (YB). In the industry, they are often used to point out employees that take up roles in SS projects along their other job responsibilities. YBs should understand and work within the SS culture but are not integral to its success (Chakrabarty and Chuan, 2009). In addition to the improvement specialists, SS roles at the higher management level are also required. They must have basic SS knowledge and support the SS program. Sponsors should be responsible for the overall initiative while Champions create the organization’s strategic improvement plans, identify the right projects and ensure the availability of resources for training and projects (Pyzdek, 2003).

### **3 RESEARCH FRAMEWORK**

The paper focuses on research findings concerning the SS belt system structure and provides an overview of the actual state of research and makes future research proposals. The research applies a systematic literature review to respond to the research objectives. According to Okoli and Schabram (2010), a systematic literature review is “a systematic, explicit, comprehensive and reproducible method for identifying, evaluating, and synthesizing the existing body of completed and recorded work produced by researchers, scholars, and practitioners”. For the proposed systematic literature review, peer-reviewed journal papers from academic databases have been taken into consideration since academics mainly use articles of the highest level of research findings to obtain information and to disseminate their own research findings. Therefore, information from editorials, news reports, textbooks and conference papers were not included in this study. Multiple high-quality online journal databases from the academic publishers, including ProQuest, Scopus, EmeraldInsight, Inderscience, and Taylor & Francis

were selected and searched to provide a comprehensive bibliography. These databases provide online access to complete research texts and abstracts of multiple peer-reviewed articles. The following search strings were used to identify the research articles of interest: [(Lean Six Sigma) or (Six Sigma) AND (Belt system) OR (Belt hierarchy) AND (Black Belt) OR (Green Belt) OR (Yellow Belt)]. The end of 2016 was selected as the cut-off date and it starts with articles from the year 2000. These criteria ensure a comprehensive set of high-quality, peer-reviewed articles. The selected articles were carefully reviewed and comprehensive data was collected in order to produce the following classification framework: (a) number of articles per year with respective researcher names, (b) application sector and organization size, (c) authors country and research country, (d) journal types with released number of articles, and (e) articles with the term „Belt“ in the title, their research focus as well as research methods.

## 4 RESULTS AND DISCUSSION

After reviewing the current literature, 62 journal papers published between the years 2000 until 2016 were selected for this analysis. These papers focused on findings regarding the SS belt system (see table 2). Half of the articles were published between 2006 and 2010. The year 2006 marks the highest number of publications with a total of 13 released articles, followed by 8 publications in 2008. Hahn et al. (2000) and Henderson and Evans (2000) were the first to include observations about SS belts in an article while Antony and Karaminas (2016) and Marzagão and Carvalho (2016) were the last researchers to do so.

Tab. 2 – Overview of publications per year and author. Source: own research

Year	No. of articles	Authors
2000	2	Hahn et al.; Henderson and Evans
2001	3	Hoerl et al.; Ingle and Roe; Klefsjo et al.
2002	3	Coronado and Antony; Rasis et al. (a) and (b)
2003	2	Byrne; Linderman et al.
2004	4	Antony, J.; Haikonen et al.; Motwani et al.; Wessel and Burcher
2005	2	Antony et al.; Gowen and Tallon
2006	13	Andersson et al.; Bendell; Black and McGlashan; Black and Revere; Buch and Tolentino (a); Buch and Tolentino (b); Green; Green et al.; Johnson et al. (a) and (b); Lee-Mortimer; Linderman et al.; Kwak and Anbari
2007	4	Antony et al. (a) and (b); Pandey; Savolainen and Haikonen
2008	8	Antony et al.; Antony; Feng and Manuel; Ho et al.; Kumar et al.; Montgomery and Woodall; Schroeder et al.; Zu et al.
2009	1	Cauchick and Marcos
2010	5	Aboelimged; Hagen; Moosa and Sajid; Pulakanam and Voges; Snee
2011	3	Kumar et al.; Leyendecker et al.
2012	4	Antony; Hilton and Sohal; Timans et al.; Zhang et al.; Laureani and Antony;
2014	2	Monteiro de Carvalho et al; Krueger et al;
2015	5	Douglas et al.; de Jesus et al.; Laux et al. (a) and (b)
2016	2	Antony and Karaminas; Marzagão and Carvalho

Overall, 38 of the 62 articles placed their focus on an application sector. Out of these 38 articles, 34 papers concentrated on the manufacturing industry whereas the service industry was looked at in four papers. Organization sizes were considered in 46 papers, however, most articles related their findings to large industries. This is the case for a total of 36 research papers while only 10 articles studied small and medium-sized enterprises. Figure 1 shows the respective journals that published at least two or more articles about this research field. The highest number of articles was released in the TQM journal, followed by the Journal of Quality Engineering and Journal of Quality & Reliability Management both of which published five articles each. The Journal of Operations Management published four articles.

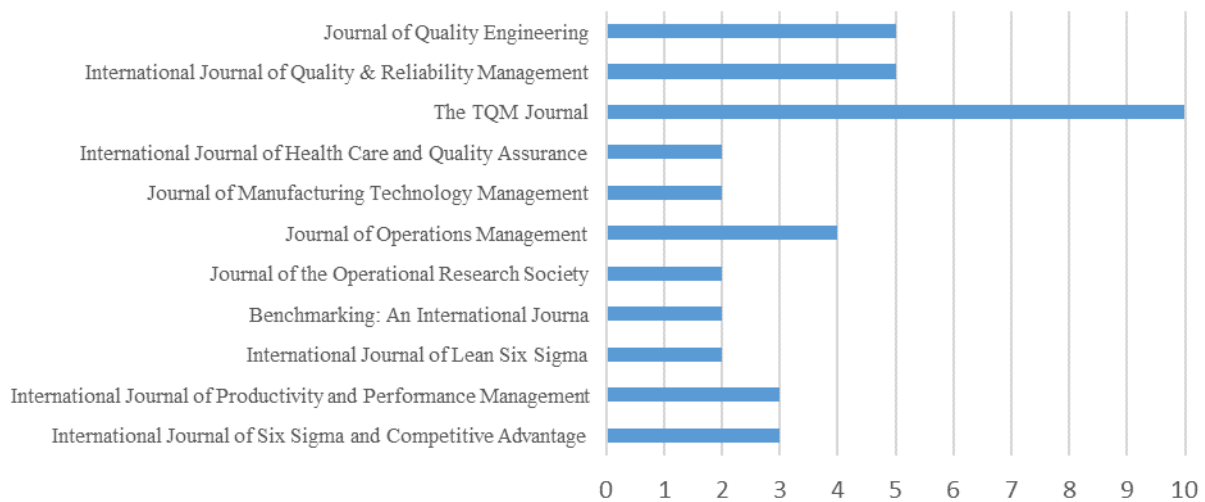

Fig. 1 – Number of published articles per journal. Source: own research

Considering all first authors as well as their co-authors, a total of 143 researchers contributed to the selected 62 articles (see figure 2). Almost half of all authors come from the USA. This also leads to the fact that most of the studies were conducted with US companies and experts. 40 papers focused their research on a specific country. The global distribution of the SS belt research demonstrates that 18 studies were conducted in the USA, followed by Asian countries (5 studies), the UK (6 studies) and the rest of Europe (6 studies) (figure 3). The second largest share of authors which makes almost 25% comes from the UK (see figure 2). This also includes Jiju Antony of the University of Strathclyde in Glasgow who is the most published researcher in this research field. Overall, he contributed to 15 research papers. He is the lead author of five papers, and a single author of three papers and a co-author of three more papers.

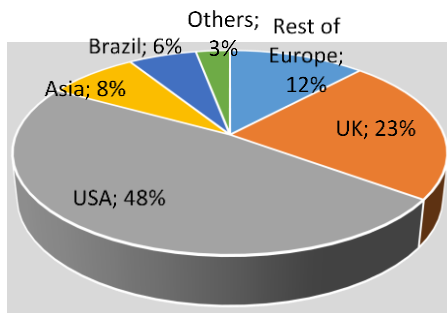

Fig. 2 - Distribution of Six Sigma belt system authors. Source: own research

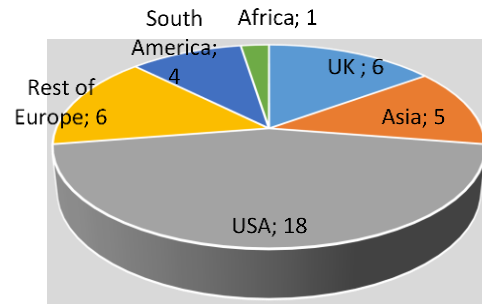

Fig. 3 - Distribution of Six Sigma belt system research countries. Source: own research

In total, 15 articles (almost 25%) have the term “Belt” in their titles, which means that the primary focus of these articles was the examination of the SS belt system (see table 3).

Tab. 3 – Literature overview about the Six Sigma belt system. Source: own research

Author and year	Author country	Research focus	Research method	Journal
Hoerl et al. (2001)	USA	BB training curriculum	Literature Review	Journal of Quality Technology
Ingle and Roe (2001)	Ireland	BB implementation	Review	The TQM Magazine
Rasis et al. (2002a)	USA	Structuring of a GB project	Case study	Journal of Quality Engineering
Rasis et al. (2002b)	USA	Structuring of a GB project	Case study	Journal of Quality Engineering

Black and McGlashan (2006)	USA	BB characteristics	Empirical study	International Journal of Six Sigma and Competitive Advantage
Green (2006)	USA	GB overview: projects, benefits, training	Empirical study	International Journal of Six Sigma and Competitive Advantage
Green et al. (2006)	USA	Implementation of SS in small companies with focus on Green Belts	Case study	International Journal of Six Sigma and Competitive Advantage
Johnson et al. (2006a)	USA	Structuring of a BB project	Case study	Journal of Quality Engineering
Johnson et al. (2006b)	USA	Structuring of a BB project	Case study	Journal of Quality Engineering
Antony et al. (2007)	UK	BB characteristics	Empirical study	The TQM Magazine
Ho et al. (2008)	Taiwan	Key success factors for GB projects	Empirical study	Journal of Air Transport Management
Hagen (2010)	USA	Impact of BB coaching expertise on project management outcomes	Empirical study	The Quality Management Journal
Laux et al. (2015a)	USA	Barriers for completion of GB projects	Empirical study	International Journal of Lean Six Sigma
Laux et al. (2015b)	USA	Planned GB project planning versus actual duration	Literature Review	Journal of Technology, Management, and Applied Engineering
Antony and Karaminas (2016)	UK	BB roles/responsibilities and skills	Empirical study	International Journal of Quality & Reliability Management

Seven articles are empirical studies, five articles are case studies and the remaining ones are literature reviews. The majority of the papers were published until 2010. Only three papers were published at a later point. Eight papers are focused exclusively on the BB. These are from the following researchers: Hoerl et al. 2001; Ingle and Roe, 2001; Black and McGlashan, 2006; Antony et al. 2007; Antony and Karaminas, 2016; Johnson et al. 2006 a. In his study Hoerl et al. (2001) developed a BB curriculum and compared this with the General Electric curriculum model. It was found that the General Electric model is mainly applicable to processes within financial organizations, general business operations and e-commerce processes while the model proposed by Hoerl et al. (2001) is mainly oriented on manufacturing organizations and focuses on explaining the use of certain tools and their integration through the project approach. Ingle and Roe (2001) compared the different implementation strategies of BB programs used in Motorola and GE. The authors concluded that the GE program has a more structured and intensive approach to train BBs in a shorter period of time which leads to a greater number of accredited BBs as compared to Motorola approach. Furthermore, they warn explicitly about the dangers of focusing mainly on metrics than on the mission in BB training, since some employees become BBs solely to benefit from promotion opportunities. The researchers Black and McGlashan (2006), Antony et al. (2007) as well as Antony and Karaminas (2016) conducted empirical studies to analyse BB characteristics. Black and McGlashan (2006) surveyed companies in a wide variety of industries in the USA, Antony et al. (2007) conducted their survey with UK manufacturing organizations and the respondents of Antony and Karaminas (2016) study came from 14 different countries whereby the majority was from India and the UK. The conclusion of these studies is that several characteristics are more essential than others. The key attributes include effective communicators, change agents, customer advocates, team builders, personnel with a results-driven mind-set and positive thinkers, etc. Another empirical study was carried out by Hagen (2010) who investigated the impact of BB's coaching expertise on project management outcomes within SS programs by collecting data of 140 BBs and 176 team members from six organizations in the USA. The results showed that the BB coaching expertise has a positive relation to the project performance. With regard to BB case studies, Johnson et al. (2006a; 2006b) published two papers focused on demonstrating the

application of the DMAIC process at BB level with the intention to provide the reader with an approach on how to structure a BB project and on how to use this model as an excellent practice example for other similar projects in future.

Beside the papers focusing on BBs, the other seven papers are taking the lesser-trained GBs into consideration. These are from the following researchers: Rasis et al. (2002a; 2002b), Green et al. (2006), Green (2006), Laux et al. (2015a; 2015b). There were also case studies carried out on this subject. Similar to the article of Johnson et al. (2006a; 2006b), Rasis et al. (2002a; 2002b) published two papers presenting an application of the DMAIC process at GB level in order to provide the readers with a profitable learning experience. In another case study, Green et al. (2006) present an approach of implementing an effective quality improvement program in a small manufacturing company by using widespread training of GBs. The employees had to participate in a training program with approximately 24 hours of classroom instruction. In addition, they also had to complete a GB project within 12 to 18 months for which they were receiving a compensation through a reward after successful graduation. During the project they were mentored by BBs. Furthermore, the certified GBs were expected to complete an additional GB project per year during their regular job assignments to maintain the certification. Since the project timeline was fixed for one year, the dedicated time for GB projects remained low (around 2-3% of the working time). Nevertheless, the duration of the project (12 months) as well as the data collection and team direction were identified as the main project barriers. As a consequence, GB projects should be designed with a shorter duration in the future. This can be achieved by adopting more lean-oriented project scopes and selecting the projects based on strategic company targets through a balanced scorecard. Green (2006) also compared the actual GBs performance in five companies against the intensity of their GB training and project duration by using structured in-depth interviews and surveys of 14 individuals. It was noted that trainings vary considerably from a few days to up to several weeks, sometimes with strong focus on classroom training and sometimes electronic-based training. Moreover, the GB project durations varied considerably from three months to up to two years, with an average of nine months which greatly exceeds the recommended duration. As common barriers emerged lack of data, unclear goals, and improper scopes and especially less time due to regular working duties. A similar study was conducted by Laux et al. (2015a) who identified barriers for GB project completions utilizing critical success factors through a survey of 18 accredited GB practitioners from a single global US manufacturing enterprise. The significant factors that contributed to a lack of GB project completion were identified as wrong project selection as well as poor project management and leadership skills. The primary factors noted by the GBs themselves were priority conflicts between SS and functional duties, time constraints and a lack of applying project management and SS tools. In addition to this study, Laux et al. (2015b) researched the timeliness of completed GB projects based on the data of the same company mentioned above. The results of this study reveal that the actual duration of the DMAIC phases of the various projects differ significantly from the planned duration. Nearly 50% of the projects took 56 days longer than planned which shows a very low process excellence. A higher focus on project management with a classified project portfolio management and initial project planning ought to improve the timeliness of GB projects. Finally, an empirical study with a similar research objective was carried out by Ho et al. (2008). This study explored key success factors that increase GB project completions by using a survey of certified GBs within a single Asian aircraft service maintenance company. The importance of the following success factors critical to GB projects became apparent: top management commitment and participation, business strategy tied to customer demands, use of data that is easily obtainable, investment of essential resources in the form of time for project completion and reward system for employees.



## 5 SUMMARY AND CONCLUSION

This paper's objective is to provide a comprehensive overview about the current research status of the Six Sigma belt system. For this review, 62 research papers from the years 2000 to 2016 were considered. Most of these papers include observations or recommendations regarding a SS belt system structure. The research aimed to provide an overview on the number of articles published per year, their authors and the countries in which the research was conducted, the number of articles published in different journal types as well as the focus of the research and the different research methods that were conducted. 15 out of the 62 analysed articles focused specifically on the investigation of the SS belt system. These articles include empirical studies, case studies as well as reviews in which primarily the roles and characteristics, barriers and success factors, training and project structure of the BB and the lesser trained GB level were examined. The MBB as well as YB level were not the focus of any of the papers that have been published until now. Based on this finding, it can be concluded that both of these belt levels should receive more attention in the future research since both play very important roles in the SS organization.

Furthermore, it could be found that the research of the SS belt system was mainly conducted with focus on large manufacturing industries. This indicates that the SS belt system for smaller companies has not yet been adequately studied and provides a field of the future research opportunities. Moreover, the authors are mainly based in the US or UK. For this reason, most research was conducted in these countries. This means that this research field has so far hardly been sufficiently explored in other regions. For this reason, further case studies, empirical studies and expert interviews about this research field ought to be conducted in different regions of the world in order to validate the current findings and recommendations and to determine a standard roadmap on how to implement a strong SS organizational infrastructure led by SS belt roles.

### Acknowledgement

The authors are thankful to the Internal Grant Agency of Tomas Bata University in Zlín IGA/FaME/2018/005 for financial support to carry out research.

### References

- Aboelmaged, M. G. (2010). Six Sigma quality: a structured review and implications for future research. *International Journal of Quality and Reliability Management*, 27(3), 268-317. doi: 10.1108/02656711011023294
- Albliwi, S. A., Antony, J., & Lim, S. A. H. (2015). A systematic review of Lean Six Sigma for the manufacturing industry. *Business Process Management Journal*, 21(3), 665-691. doi: 10.1108/BPMJ-03-2014-0019
- Andersson, R., Eriksson, H., & Torstensson, H. (2006). Similarities and differences between TQM, Six Sigma and lean. *The TQM Magazine*, 18(3), 282-296. doi: 10.1108/09544780610660004
- Antony, J. (2004). Six Sigma in the UK service organizations: results from a pilot survey. *Managerial Auditing Journal*, 19(8), 1006-1013. doi: 10.1108/02686900410557908

- Antony, J., Kumar, M., & Madu, C. (2005). Six Sigma in small and medium-sized UK manufacturing enterprises: some empirical observations. *International Journal of Quality & Reliability Management*, 22(8), 860-74. doi: 10.1108/02656710510617265
- Antony, J., Antony, F., & Kumar, M. (2007a). Six Sigma in service organizations: benefits, challenges and difficulties, common myths, empirical observations and success factors. *International Journal of Quality & Reliability Management*, 24(3), 294-311. doi: 10.1108/02656710710730889
- Antony, J., Douglas, A., & Antony, F. (2007b). Determining the essential characteristics of Six Sigma black belts: results from a pilot study in UK manufacturing companies. *The TQM Magazine*, 19(3), 274-281. doi: 10.1108/09544780710745685
- Antony, J., Kumar, M., & Labib, A. (2008). Gearing Six Sigma into UK Manufacturing SMEs: Results from a Pilot Study. *The Journal of the Operational Research Society*, 59(4), 482-493. doi: 10.1057/palgrave.jors.2602437
- Antony, J. (2008). Can six sigma be effectively implemented in SMEs?. *The TQM Magazine*, 57(5), 420-423. doi: 10.1108/17410400810881863
- Antony, J. (2012). A SWOT analysis on Six Sigma: some perspectives from leading academics and Practitioners. *International Journal of Productivity and Performance Management*, 61(6), 691-698. doi: 10.1108/17410401211249229
- Antony, J., & Karaminas, H. (2016). Critical assessment on the Six Sigma Black Belt roles/responsibilities, skills and training: A global empirical study. *International Journal of Quality & Reliability Management*, 33(5), 558-573. doi: 10.1108/IJQRM-08-2014-0106
- Arnheiter, E. D., & Maleyeff, J. (2005). The integration of lean management and Six Sigma. *The TQM Magazine*, 17(1), 5-18. doi: 10.1108/09544780510573020
- Black, K., & McGlashan, R. (2006). Essential characteristics of Six Sigma black belt candidates: a study of US companies. *International Journal of Six Sigma and Competitive Advantage*, 2(3), 301-312. doi: 10.1504/IJSSCA.2006.011120
- Black, K., & Revere, L. (2006). Six Sigma arises from the ashes of TQM with a twist. *International Journal of Health Care Quality Assurance*, 19(2), 259-266. doi: 10.1108/09526860610661473
- British Standards Institute (BSI): BS ISO 13053 – 1:2011. Quantitative Methods in Process Improvement – Six Sigma. Part 1 DMAIC Methodology, BSI, London.
- Bendell, T. (2006). A review and comparison of Six Sigma and the lean organizations. *The TQM Magazine*, 18(3), 255-262. doi: 10.1108/09544780610659989
- Buch, K., & Tolentino, A. (2006a). Employee perceptions of the rewards associated with Six Sigma. *Journal of Organizational Change Management*, 19(3), 356-364. doi: 10.1108/09534810610668355
- Buch, K., & Tolentino, A. (2006b). Employee expectancies for Six Sigma success. *Leadership & Organization Development Journal*, 27 (1), 28-37. doi: 10.1108/01437730610641340
- Byrne, G. (2003). Ensuring optimal success with Six Sigma implementations. *Journal of Organizational Excellence*, 22(2), 43-50. doi: 10.1002/npr.10066
- Cauchick, M., & Marcos, A. (2009). Benchmarking Six Sigma application in Brazil: Best practices in the use of the methodology. *Benchmarking. An International Journal*, 16(1), 124-134. doi: 10.1108/14635770910936559

- Chakrabarty, A., & Chuan T. K. (2009). An exploratory qualitative and quantitative analysis of Six Sigma in service organizations in Singapore. *Management Research News*, 32(7), 614-632. doi: 10.1108/01409170910965224
- Coronado, R. B. & Antony, J. (2002). Critical success factors for the successful implementation of Six Sigma projects in organizations. *The TQM Magazine*, 14(2), 92-99. doi: 10.1108/09544780210416702
- Douglas, A., Douglas, J., & Ochieng, J. (2015). Lean Six Sigma implementation in East Africa: findings from a pilot study. *The TQM Journal*, 27(6), 772-780. doi: 10.1108/TQM-05-2015-0066
- Feng, Q., & Manuel, C.M. (2008). Under the knife: A national survey of six sigma programs in US healthcare organizations. *International Journal of Health Care Quality Assurance*, 21(6), 535-547. doi: 10.1108/09526860810900691
- Green, F. (2006). Six Sigma and the green belt perspective: a study in five companies. *International Journal of Six Sigma and Competitive Advantage*, 2(3), 291-300. doi: 10.1504/IJSSCA.2006.011119
- Green, F., Barbee, J., Cox, S. & Rowlett, C. (2006). Green belt Six Sigma at a small company. *International Journal of Six Sigma and Competitive Advantage*, 2(2), 179-189. doi: 10.1504/IJSSCA.2006.010108
- Gowen, C., & Tallon, W. (2005). Effect of technological intensity on the relationship among Six Sigma design, electronic business, and competitive advantage: a dynamic capability model. *Journal of High Technology Management Research*, 16(1), 59-87. doi: 10.1016/j.hitech.2005.06.004
- Hagen, M. (2010). Black belt coaching and project outcomes: an empirical investigation. *The Quality Management Journal*, 17(2), 54-67. doi: 10.1080/10686967.2010.11918270
- Hahn, G., Doganaksoy, N., & Hoerl, R. (2000). The evolution of Six Sigma. *Quality Engineering*, 12(3), 317-326. doi: 10.1080/08982110008962595
- Haikonen, A., Savolainen, T., & Järvinen, P. (2004). Exploring Six Sigma and CI capability development: preliminary case study findings on management role. *Journal of Manufacturing Technology Management*, 15(4), 369-378. doi: 10.1108/17410380410535071
- Henderson, K., & Evans, J. (2000). Successful implementation of Six Sigma: benchmarking General Electric Company. *Benchmarking: An International Journal*, 7(4), 260-281. doi: 10.1108/14635770010378909
- Hilton, R.J., & Sohal, A. (2012). A conceptual model for the successful deployment of Lean Six Sigma. *International Journal of Quality & Reliability Management*, 29(1), 54-70. doi: 10.1108/02656711211190873
- Hoerl, R., Montgomery, D., Lawson, C., Molnau, W., Elias, R., Abraham, B., MacKay, J., Snee, R., Pyzdek, T., Hill, W., Breyfogle, F., Enck, D., Meadows, B., & Bailey, S. (2001). Six Sigma black belts: what do they need to know?. *Journal of Quality Technology*, 33(4), 391-435. doi: 10.1080/00224065.2001.11980094
- Ho, Y., Chang, O., & Wang, W. (2008). An empirical study of key success factors for Six Sigma green belt projects at an Asian MRO company. *Journal of Air Transport Management*, 14(5), 263-269. doi: 10.1016/j.jairtraman.2008.05.002

- Ingle, S., & Roe, W. (2001). Six Sigma black belt implementation. *The TQM Magazine*, 13(4), 273-280. doi: 10.1108/09544780110391666
- Jesus, A., Antony, J., Lepikson, H., & Peixoto, A. (2016). Six Sigma critical success factors in Brazilian industry. *International Journal of Quality & Reliability Management*, 33(6), 702-723. doi: 10.1108/IJQRM-08-2014-0120
- Johnson, J., Gitlow, H., Widener, S., & Popovich, E. (2006a). Designing new housing at the University of Miami: a 'Six Sigma' DMADV/DFSS case study. *Quality Engineering*, 18(3), 299-323. doi: 10.1080/08982110600719399
- Johnson, J., Widener, S., Gitlow, H., & Popovich, E. (2006b). A Six Sigma black belt case study: GEP Box's paper helicopter experiment – part A. *Quality Engineering*, 18(4), 413-430. doi: 10.1080/08982110600875894
- Klefsjo, B., Wiklund, H., & Edgeman, R. (2001). Six Sigma seen as a methodology for total quality management. *Measuring Business Excellence*, 5(1), 31-35. doi: 10.1108/13683040110385809
- Krueger, D.C., Parast, M.M., & Adams, S. (2014). Six Sigma implementation: a qualitative case study using grounded theory. *Journal of Production Planning & Control*, 25(10), 873-889. doi: 10.1080/09537287.2013.771414
- Kumar, M., Antony, J., Madu, C., Montgomery, D.C., & Park, S. H. (2008). Common myths of Six Sigma demystified. *International Journal of Quality & Reliability Management*, 25(8), 878-889. doi: 10.1108/02656710810898658
- Kumar M., Anthony J., & Tiwari, M.K. (2011). Six Sigma implementation framework for SMEs – a roadmap to manage and sustain the change. *International Journal of Production Research*, 49(18), 5449-5467. doi: 10.1080/00207543.2011.563836
- Kwak, Y.H., & Anbari, F.T. (2006). Benefits, obstacles and future of Six Sigma approach. *Technovation*, 26(5-6), 708-715. doi: 10.1016/j.technovation.2004.10.003
- Laux C., Johnson M., & Cada P. (2015a). Project barriers to Green Belts through critical success factors. *International Journal of Lean Six Sigma*, 6(2), 138-160. doi: 10.1108/IJLSS-02-2014-0006
- Laux C., Johnson M., & Cada P. (2015b). LSS Green Belts projects planned versus actual duration. *The Journal of Technology, Management, and Applied Engineering*, 31(1), 1-18. Retrieved from <https://www.atmae.org/page/JTMAEArticles>
- Laureani, A., & Antony, J. (2012). Critical success factors for the effective implementation of Lean Sigma. *International Journal of Lean Six Sigma*, 3(4), 274-283. doi: 10.1108/20401461211284743
- Lee-Mortimer, A. (2006). Six Sigma: effective handling of deep rooted quality problems. *Assembly Automation*, 26(3), 200-204. doi: 10.1108/01445150610679731
- Leyendecker B., Schindewolf S., Hutwelker R., & Weigel H. (2011). Erfolgsfaktoren für die Etablierung von Six Sigma: Bei guter Führung wertvoll. *QZ Qualität und Zuverlässigkeit*, 7, 29-33.
- Linderman, K., Schroeder, R., Zaheer, S., & Choo, A. (2003). Six Sigma: a goal-theoretic perspective. *Journal of Operations Management*, 21(2), 193-203. doi: 10.1016/S0272-6963(02)00087-6

- Linderman, K., Schroeder, R., & Choo, A. (2006). Six Sigma: the role of goals in improvement teams. *Journal of Operations Management*, 24(6), 779-790. doi: 10.1016/j.jom.2005.08.005
- Marzagao, D. S. L., & Carvalho, M. M. (2016). Critical success factors for Six Sigma Projects. *International Journal of Project Management*, 34(8), 1505-1518. doi: 10.1016/j.ijproman.2016.08.005
- Monteiro de Carvalho M., Lee Ho L., & Helena Boarin Pinto S. (2014). The Six Sigma Program: An empirical study of Brazilian companies. *Journal of Manufacturing Technology Management*, 25(5), 602-630. doi: 10.1108/JMTM-04-2012-0045
- Montgomery D. C., & Woodall H. W. (2008). An overview of Six Sigma. *International Statistical Review*, 76(3), 329-346. doi: 10.1111/j.1751-5823.2008.00061.x
- Motwani, J., Kumar, A., & Antony, J. (2004). A business process change framework for examining the implementation of Six Sigma: a case study of Dow Chemicals. *The TQM Magazine*, 16(4), 273-283. doi: 10.1108/09544780410541927
- Moosa, K., & Sajid, A. (2010). Critical analysis of Six Sigma implementation. *Total Quality Management*, 21(7), 745-759. doi: 10.1080/14783363.2010.483100
- Okoli, C., & Schabram, K. (2010). A guide to conducting a systematic literature review of information systems research. *Sprouts: Working Papers on Information Systems*, 10(26), 1-51. Retrieved from <http://sprouts.aisnet.org/10-26>
- Pandey, A. (2007). Strategically focused training in Six Sigma way: a case study. *Journal of European Industrial Training*, 31(2), 145-162. doi: 10.1108/03090590710734363
- Pulakanam V., & Voges K.E. (2010). Adoption of Six Sigma: Review of empirical research. *International Review of Business Research Papers*, 6(5), 149-163. Retrieved from [https://www.researchgate.net/publication/283813687\\_Adoption\\_of\\_Six\\_Sigma\\_Review\\_of\\_Empirical\\_Research](https://www.researchgate.net/publication/283813687_Adoption_of_Six_Sigma_Review_of_Empirical_Research)
- Pyzdek T. (2003). *The Six Sigma handbook. A complete Guide for Green Belts, Black Belts, and Managers at All Levels.* New York, USA: McGraw-Hill.
- Rasis, D., Gitlow, H., & Popovich, E. (2002a). A fictitious Six Sigma green belt case study. I. *Quality Engineering*, 15(1), 127-145. doi: 10.1081/QEN-120006715
- Rasis, D., Gitlow, H., & Popovich, E. (2002b). A fictitious Six Sigma green belt case study. II. *Quality Engineering*, 15(2), 259-174. doi: 10.1081/QEN-120015858
- Richardson, K. (2007). The Six Sigma factor for home depot. *Wall Street Journal*, C3.
- Savolainen, T., & Haikonen, A. (2007). Dynamics of organizational learning and continuous improvement in Six Sigma implementation. *The TQM Magazine*, 19(1), 6-17. doi: 10.1108/09544780710720808
- Schroeder, R.G., Linderman, K., Liedtke, C., & Choo, A. (2008). Six Sigma: definition and underlying theory. *Journal of Operations Management*, 26(4), 536-554. doi: 10.1016/j.jom.2007.06.007
- Snee R.D. (2010). Lean Six Sigma – getting better all the time. *International Journal of Lean Six Sigma*, 1(1), 9-29. doi: 10.1108/20401461011033130
- Timans, W., Antony, J., Ahaus, K., & van Solingen, R. (2012). Implementation of Lean Six Sigma in small- and medium-sized manufacturing enterprises in the Netherlands. *Journal of the Operational Research Society*, 63(3), 339-353. doi: 10.1057/jors.2011.47

- Wessel G., & Burcher P. (2004). Six Sigma for small and medium-sized enterprises. *The TQM Magazine*, 16(4), 264-272. doi: 10.1108/09544780410541918
- Zu, X., Fredendall, L.D., & Douglas, T.J. (2008). The evolving theory of quality management: the role of Six Sigma. *Journal of Operations Management*, 26(5), 630-650. doi: 10.1016/j.jom.2008.02.001
- Zhang, Q., Irfan, M., Khattak, M.A.O., Abbas, J., Zhu, X., & Shah, M.S. (2012). Critical success factors for successful Lean Six Sigma implementation in Pakistan. *Interdisciplinary Journal of Contemporary Research in Business*, 4(1), 117-124.

### Contact information

#### **Roland Stankalla, M.Sc.**

Tomas Bata University in Zlín, Faculty of Management and Economics  
Mostní 5139, 76001 Zlín, Czech Republic  
E-mail: roland.stankalla@yahoo.com  
ORCID: 0000-0002-7225-8487

#### **prof. Ing. Felicita Chromjaková, PhD.**

Tomas Bata University in Zlín, Faculty of Management and Economics  
Mostní 5139, 76001 Zlín, Czech Republic  
E-mail: chromjakova@utb.cz  
ORCID: 0000-0002-5084-1153

doi: 10.7441/dokbat.2019.095

# POTENTIALS OF KPI SYNCHRONIZATION IN THE SUPPLY CHAIN

*Diána Strommer*

## Abstract

In today's working environment the competition is fierce not only between companies but also between supply chains. Due to the circumstances it is very important to identify where the focus should be placed. In this article the characteristics of the supply chain echelons are presented. The aim of the article is summarizing the focus of measures on different parts of the supply chain. This article presents the different perspectives of the different levels. The study is based on literature review, the theoretical background is summarized by the author in a separate chapter. Based on the literature review risks and opportunities are checked and presented. The analysis is concentrating on the connection and collaboration between the different elements of the chain. To be able to work in a more productive way it is very important to see what the areas are where cooperation or information sharing can result in more successful operation. These areas can be used as opportunities. On the other hand, risks also need to be assessed in advance, this way the negative effects can be eliminated. The aim of the article is not only presenting the measurement focus of the supply chain elements but also analysing the risks and opportunities between the different echelons. As the core element of risks and opportunities, this study points on the importance of information and knowledge sharing.

**Keywords:** *supply chain echelons, KPIs on different levels, risk and opportunities in cooperation*

## 1 INTRODUCTION

The goal of logistics and supply chain management is ensuring the smooth and cooperative operation of the different echelons on the same frame. The aim is securing the best possible results in regards of efficiency in the network. During this the global goals are overwriting or at least adjusting the local targets to reach the best overall results. The chains are complex and complicated networks due to the number of participants and because of the numerous connections. To simplify the network four level can be differentiated which is presented on Figure 1. The group of echelons include multiple members with various connections to the other groups. (Christopher, 2016)

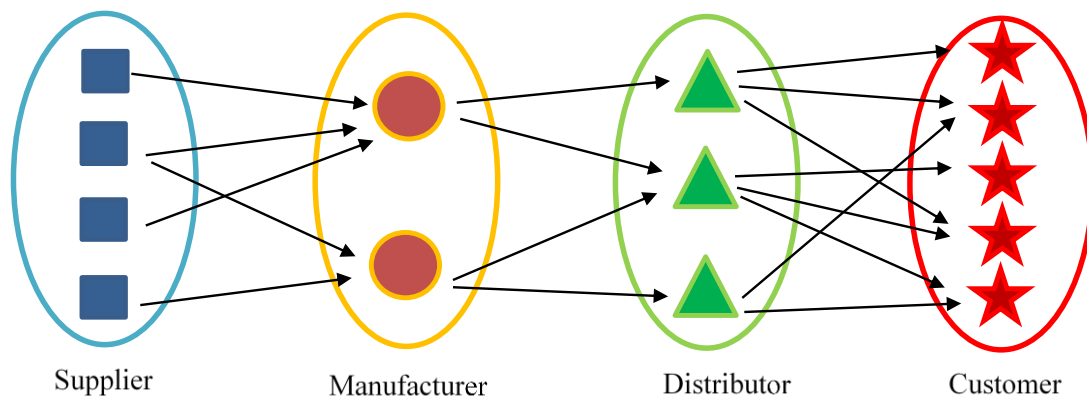

Fig. 1 – Supply chain schema. Source: Christopher (2016)

It is important and challenging to work on optimizing the performance based on the chain level goals. Echelons need to have adjusted goals based on their specification to reach the aimed

global performance. To reach this level increase of efficiency and continues improvement of the processes are needed. Performance measurement support this. As the different groups in the chain varies a lot the same structure cannot be used in each case. Methods and measured key performance indicators (KPIs) need to be identified based on the profile of the given part of the chain. The metrics differs but the main goal is common: identification of the underperforming areas, definition of improvement potentials and initiation of changes for the better result. The goal of this article is presenting the main specifications of the echelons or groups of echelons by showing the metrics and priorities considered crucial in their operation. It is important to see on each level what is crucial, but it is not enough. The collaboration of the different roles drives to risks and opportunities that can have impact on the efficiency. Considering these elements, the measurement frames can also be adjusted to reach the best result. In chapter three the author presents some potential areas that can be realized as risk or opportunity.

## **2 MEASURES ON DIFFERENT LEVELS**

In this chapter literature review is presented. The focus is on different priorities and interest of the elements of the supply chain. The starting point is on one hand the supplier providing raw materials. The main local goal is maximizing capacity utilization without any inventory kept. Manufacturing is the next step where the finished goods are finalized. The aim is reaching the economy of scale, reducing waste and utilize fully the equipment. Distributor is a link between the customer and the production with goal of reaching the balance situation between the other functions. The customer is the other edge of the chain. At the end of the day the needs generated on this level are the most important and affecting the full chain. Goal of this chapter is summarizing measures on different element of the supply chain.

### **2.1 Supplier**

Supplier is the first element of the chain. This element can be source of raw material for the manufacturing locations, but it also can be source for parts or semi-finished products. Even though the common final goal of the chain is satisfying the customer's needs this requirement is less tangible in this part of the chain due to the number of echelons in between. The final goal needed to be taken into consideration but to reach that manufacturing plants, distributors and wholesale or retail partners can distort the information or request. In the level of the supplier the local needs must be harmonized with manufacturing strategies and requirement. Without considering the chain perspective the lead times would be very long and hectic on the supplier side. Adaptation to ad-hoc requirements cost extra effort and money for the supplier. It can cause extra shifts or change of plans with the result of decrease in capacity utilization.

There are several common points with manufacturing regarding the KPIs as several cases supplier has also some assembly or preparatory activity on the product. Manufacturing performance indicators (more detail in the next subchapter) can also be applicable for supplier. (Manotas & Cadavid, 2007)

The goals of the supplier need to be defined considering the requirements and goals of the manufacturing location(s). The difficulty can also come from the high number of production plants served by the same supplier with totally different rules and requirements. As one supplier can be part of several chain a lot of different requirement need to be met. This makes it even more difficult to set up a harmonized KPI system or processes. (Cousins et al., 2008)

From stock keeping perspective supplier tries to minimize the amount stored. To ensure this the offered batches are usually quite big to reach the economy of scale. This result in the proper level of capacity utilization and minimize the money kept on stock. As producing or preparing



this bigger batches needs time, mid- and long-term planning is essential. These plans enable the supplier to have proper capacity utilization not only on short term. (Cousins et al., 2008)

Besides the planning the reaction time also need to be in focus. Big batches reserve high percentage of the capacity and increase the reaction time, it is difficult to make changes in production without decreasing the productivity. To ensure advanced planning on supplier side all elements in the chain should be able to provide high quality forecast mid and long-term and avoid the short-term changes. (Waters, 2010)

Sharing risk is an aim for a supplier as sourcing raw materials and semi-finished goods can mean not only opportunity. Special items may not be sellable for other partners on the market. Changing strategy or portfolio can generate not needed stock which can easily result in loss. Sharing the risk can enable the manufacturer by more flexible conditions (like faster reaction or smaller batch) and on the other hand secure the supplier from the lost sales. (Wisner, Tan & Leong, 2012)

## 2.2 Manufacturer

Manufacturing locations are in the middle part of the supply chain. They are sourcing raw material or parts from different suppliers, producing the finished goods and sending it to the distribution centre for further trading. If the plants would only consider local goals the production would run in quite high batches, lead time would be longer, and no finished goods stock would be in the location. Furthermore, the production plan would be set based on the best overall utilization of the equipment and workforce. Price and availability of raw material would have high effect on the produced item and quantity. This is not likely to happen as distribution centres, wholesalers and retailers has limited storage capacity, the customer may not only need the most profitably produced product, seasonality also need to be considered and the willingness to wait is also limited on the side ode the other echelons.

The main KPIs used in manufacturing are also called MPIs (manufacturing performance indicators). These metrics not only need to take into consideration the goals of the plants but also the fulfilment of the requirements from the distributors. To improve industrial performance benchmarking is also widely used. Numerous case studies can be found which support to identify and improve the poor performing areas. Those studies also show benchmark results and processes that support the implementation. Key performance indicators can be used to investigate full processes but also different areas such as product quality. (Lindberg et al., 2015)

Measures can be categorized in several ways. One way is the lean approach. The core of this idea is the lean thinking meaning elimination of waste and creation of value. For this it needs to be specified what the value is for the customer. Based on that the value stream need to be identified in the full supply chain. In lean supply chains focus should be on pull system, mass production and pushing goods on customers should be avoided. Furthermore, the improvement should continuously happen in the supply chain. The activities in the manufacturing locations should be also analysed through the lean lenses and the waste activities need to be identified and eliminated as a performance improvement approach. (Manotas & Cadavid, 2007)

As mentioned, waste identification is core in the lean approach. Many KPIs can be used for this purpose. Lindberg et al. (2015) identified the below categories of KPIs in manufacturing area. The calculation is quantifying by division of in and output: **(a) Energy KPIs:** energy input and produced output, it can be for example electricity or biomass; **(b) Raw material KPIs:** under raw material we can also understand some chemical elements or water. Raw material input can be also divided by produced output; **(c) Operational KPIs:** comparison on actual and planned process is under here, e.g. time or needed workforce; **(d) Control performance KPIs:** the main point here is the outcome of the production so comparison can be made on quality problematic

items compared to the total; **(e) Maintenance KPIs:** Maintenance is needed for the proper operation, but it cost money so too much can be pull back on reaching goals. Here we can compare for example maintenance cost vs total output cost in each time period; **(f) Planning KPIs:** under this KPI capacity utilization should be determined; **(g) Inventory and buffer utilization KPIs:** Here the task is also finding the balance. Inventory cost money, but buffer is needed. The proper items and quantity need to be identified. For quantify average inventory can be checked; and **(h) Equipment KPIs:** The condition of the used equipment is highly affecting the operation. It needs to be monitored to make sure proper maintenance plan is defined. Here real and predicted performance can be compared. (Lindberg et al., 2015)

Sustainability is another approach. The availability of resources in several cases are more and more limited. This is challenging for the manufacturing locations also. Due to this the cradle-to-grave way of thinking is started to be written over be the cradle-to-cradle method. This change also effects the performance indicators. Green KPIs are introduced to the performance measurement frame such as environmental impact. The green approach is also visible in the focus of the life cycle which takes the post-usage also into consideration. The goal is the more efficient utilization of resources, reduction of emission and improvement of health and safety. For this perspective manufacturing highly needs to be in focus. (Huang & Badurdeen, 2017)

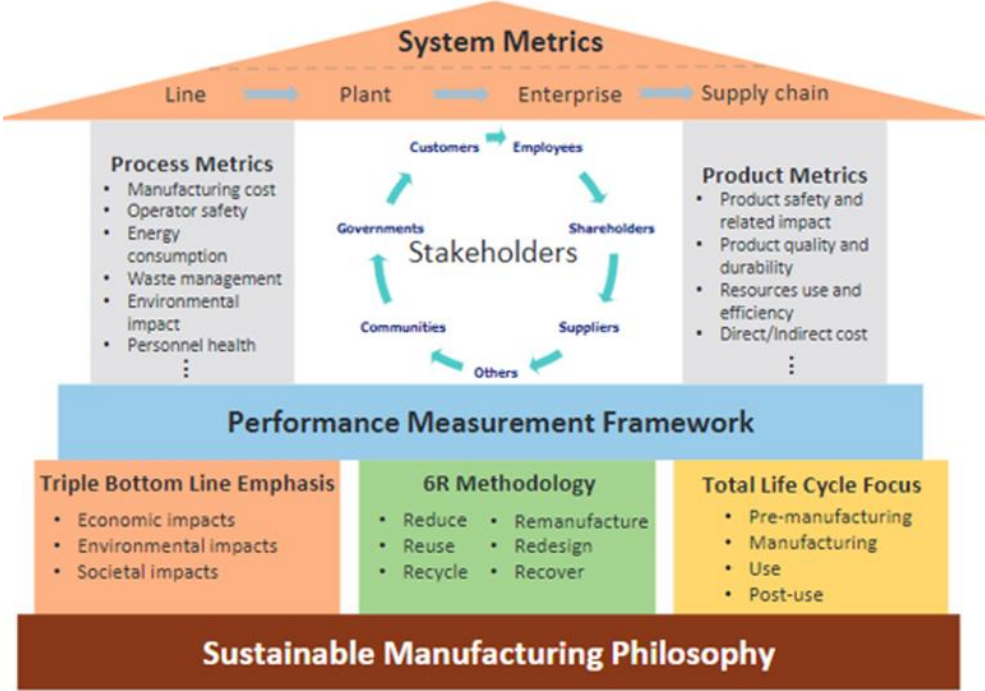

Fig. 2 – Sustainable manufacturing performance measurement house. Source: Huang & Badurdeen (2016)

Overall Equipment Effectiveness (OEE) is designed also to support performance measurement and improvement. OEE itself is a percentage term calculated by multiplication of availability, quality and performance. Each of the three is quantifying a malfunction. Availability stands for down time calculated by operating time divided by planned production time. Quality losses are showing the ratio of correct goods calculated by dividing number of good products and total number of products in a chose period. Under performance metric speed is considered. Theoretical or ideal speed is compared to the actual numbers, it is handled as 100% if the process is running on maximum. The calculation can be simplified. Saleable units produced divided by maximum units produced should give the similar ratio as the above mentioned. (Thomson, 2016)

### **2.3 Distributor**

The distributor echelon differs significantly from the manufacturing. The distributor is not working anymore with semi-finished goods and production. The role is usually division of goods among e.g. regions or countries. Here the customer is closer, so the information distortion is smaller than for the supplier and the manufacturer. For this point of the chain the priorities are different. As no production activity is included in the operational business so the economies of scale have indirect importance. It is also important that neither raw material nor semi-finished goods are used or stored on this level. Due to this only finished goods are in the focus. As the stock means waste of capital, the goal is to keep the level low. Overall goal is maximizing the turnover with the minimum possible inventory kept.

Since customer satisfaction is goal for the full supply chain importance of distributor is high as a face of the company. This is the echelon where the customer service level can be measured, improvement actions can be taken. Service level calculation differs company by company but the essential of it is the same. The placed and the fulfilled orders are compared with each other. There can be some correction used for example to exclude phased out products, new products or items not available for the segment. Here the balance between the cost elements and a level of service is crucial to find. (Sawik, 2014)

Part of the cost mentioned before is coming from stock keeping. Dead stock generated in the supply chain means difficulty. These items are usually difficult to sell due to for example price, lack of customer need or better offer from the competitor. To avoid dead stock, obsolete stock or long coverage forecast quality need to be improved. To measure this quality for example forecast accuracy and forecast bias can be used. These two measures show how good the forecast is. The accuracy is a figure to show the relation of real sales figures and the forecast (usually in the beginning of a frozen period e.g. 1 month), bias shows if the estimations are above or below the real number, so the portfolio or group of products are over or under forecasted. (Rushton, Croucher & Baker, 2010)

From the distributor point of view not only the customer satisfaction and forecast quality needs to be in focus but also the lead time. During the planning process of planning all time related actions need to be considered. Both production time and delivery time need to be taken into consideration. It also needs to have the proper buffer to make sure that administrative tasks can also be included in this frame. (Rushton, Croucher & Baker, 2010)

### **2.4 Customer**

The focus on the customer's need is inevitable. The measures and the weight of the customer can differs based on industry, product or sales strategy. Even considering these differences the importance of the customer stays on the high level. Based on this the metrics should be defined considering the main priorities of the customer.

From the customer perspective the evaluation of the product or service is only happening when it is handed over. Because of this from the customer point of view the level of this hand over is very important and considered as part of the value of the item purchased. This touchpoint between the user and the seller can be used to include additional value (e.g. warranty, delivery conditions, gifts, special packages, etc.). As mentioned, customer focus is a must so this kind of opportunities can and should be used to differentiate from the competitors. In today's market price is not the only element adjudicate the market share and position of a company or supply chain. (Harrison & Hoek, 2008)

Customer focus on the final product delivered as mentioned before. Even if the core of the value is created on the manufacturing side customer will concentrate on the value in hand not the

process of the generation. Customer has much more opportunity to compare competitor products and to analyse the market trends. Easy and widely available sources are making harder to fully satisfy customer needs. (Harrison & Hoek, 2008) The customer measures the product or service and the value it generates. The focus is on the level of fulfilment of the needs.

There is a conflict between logistics aims and customer's expectations. In the fierce competition users want to personalize as much as possible the goods available in the market. It may seem small change but if we check it from supply chain point it means much bigger effort. For example, we have 0.33 l and 0.5 l bottles in the market and group of customers starts to ask for 0.4 dl bottle. From the user perspective it is a slight change in size fits better to his or her lifestyle. For the supply chain it means new product to be developed, new packaging, different production requirement, and product test to be done. It cost energy, time, and money. It may also come out at the end when item is launched in the market that customers do not like the product at all and it will not be a profitable change.

The other conflict is on the time perspective. Most of the cases the different echelons on the chain are located far from each other. It can happen that the supplier, the manufacturing and the sales of the product locates in a different continent. In contrast the customer request and require product to be available nearby and on the needed format, quantity and quality. The customer does not take into consideration how far the product needs to travel to get the aimed shape. Long lead time is not accepted in most cases. This is in contrast with the company's interest as for them stock means cost, money input with questionable return.

## **2.5 Supply Chain Collaboration**

In the previous part focus areas and priorities has been defined on echelon level. It is important to see what the key points are for each element, but it is not enough. Collaboration between the relevant parts of the chain is continuously happening on different levels.

Several different ways of collaboration can occur in the supply chains. In the traditional method communication is only based on replenishment or production orders, no further information is shared between the members. The information exchange supply chain is closer to the final demand, to the customer. Here all level is aware of the customer demand, forecasting systems and inventory planning can be advanced based on this. In the proposed collaboration model the order quantity is based on the replenishment strategy used. In this level sharing of forecasted demand and replenishment strategy is suggested to be shared. (Shaban, 2019)

Different factors or goals also can be defined that driving the collaboration. From financial perspective cutting cost and maximizing level of profit is the main motivation. There is also a business objective that aims to reach the needed service level to retain the customers. The third factor can be the supply chain process which differ based on product, industry or strategy. Here the aim is mainly optimizing the lead time. The degree of collaboration examines how deeply the echelons are connected and what the level of involvement is. Finally, the information sharing need to be defined: what content, how, with whom should be shared. (Ramanathan, 2014)

Supply Chain collaboration is a complex area. Several case studies have been presented on the topic but defining the level and tools to be used. Finalizing of the needed methodology is still difficult as all the potential gains and failures should be define for the given echelon of the given industry. Benchmarks can support in definition of the possibilities and the starting point, but still a lot of analytical work need to be done to reach the best possible result.

### 3 RISKS AND OPPORTUNITIES

In the second chapter based on the theoretical background the focus areas have been presented on the different levels of the supply chain. Collaboration has also been pointed out as an important area. It is important to see the full process in connections and on chain level. In the following chapter the risks and opportunities are presented. These areas are investigated from the cooperation point of view. As the results and profitability is highly depending on the full network of the supply chain the elements are not only important separately but also the interfaces are crucial to check.

#### 3.1 Risk of common work

Considering all the echelons of the chain we can see that the different levels can benefit from each other. In the same time, we also need to assume that they need to define and eliminate the risk which is endangering them through these connections. In table 1 the risks are presented which are threatening the operation on the chosen stakeholder: Table 1 summarize the risk of the common work in the supply chain.

Tab. 1 – Risks of common work. Source: own research

Risks	Supplier	Manufacturer	Distributor	Customer
For the supplier		Look for another source	Change requirement	Discontinuation of product
For the manufacturer	Time/quality		Demand fluctuation	Demand changes
For the distributor	Delay, quality, moq	Flexibility, transparency		Inaccurate forecast

Regarding the supplier the closest contact is with the manufacturer. Due to the competitive environment in the cooperation with the manufacturer level of service and collaboration is very important. Manufacturer can look for other sources or even insourcing of the process can be feasible. For the supplier it is essential to make to product or service unique or the collaboration fruitful for all parties. The distributor and the customer have indirect effect. Mainly changed or discontinued market demand has impact on their processes. It can result in huge overstocks and poor capacity utilization.

The manufacturer is in close contact both with distributor and supplier. From the supplier side the main risk is on the reliability. Manufacturing has several fixed requirements. Due to the setup of the production lines and the regulations toward the products. There are important not only the legal and mechanical requirements, but also the customer’s requirement on product quality. This result in high standard requested from the supplier. If the quality is not proper the final product will also not be perfect, may not even pass the internal tests. The other risk is on time delivery. Delay endanger the on-time availability and have effect on the capacity utilization. Production plan need to be changed if possible or if not, it results in loss.

Adaptation is also requested from the other side. Even the steadiest products can be promoted or positioned differently in the market. If it is not estimated properly on the forecast and information is not shared the manufacturing can be in trouble in serving these requirements. This shows and example why transparency is very important in the supply chain. This demand fluctuation can be determined as a risk between production plants and the distribution. Customer has similar impact on the manufacturer. Without any promotion or price change market’s need can increase or decrease. It can be the result of political or economic changes, new products of competitors or some newly presented risk about the product. It results in the same risk for manufacturer. Here the result can also be overstock or not perfect capacity

utilization. In extreme case it can also cause need to shut down or reconstruction of production lines.

For the distributor the customer is already close contact. Market trends and guided promotions can give inputs on expected sales level, but it will still be just expectations. Here the risk is partly coming from the political and economic situation which is very difficult to be predicted. The other risk is coming from the market behaviour. The competitors can have huge impact on results of the activities. Also new products can change the demand, make customers switch from one product or product group to the other. Overall with all these difficulties the result can be inaccurate and not reliable planning.

The risk is also existing on the other side. Lack of flexibility and lack of transparent operation can make the cooperation with the manufacturing difficult. Without a certain level of flexibility, it is not possible to adapt at all to customer's needs. The transparency is mainly important regarding set and sometimes change of priorities to make sure that the requested products are produced. The flexibility can also be limited by the supplier. Minimum order quantity (MOQ) can be very high, which means high needed demand to be able to consume the full portion. Quality is also highly depending on the supplied materials and time perspective is highly impacted as well.

### 3.2 Opportunities in the collaboration

Besides the risks there are also opportunities in the collaboration of the echelons. If it can be managed on chain level the efficiency of the supply chain can be increased. To ensure cooperation in the full chain first it is good to see it on smaller level. Below figure shows example of opportunities based on extended information flow in the supply chain. This analysis consider that at least basic level of information sharing is set up between the supply chain echelons.

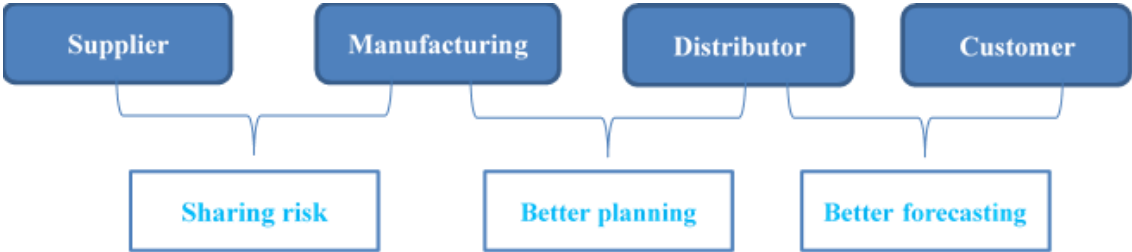

Fig. 3 – Opportunities in the supply chain. Source: own research

Supplier and manufacturer share interest in several elements. Introduction of new products means risk for both parties. To eliminate or reduce this kind of risks sharing information is a great support. Collaboration can result in higher flexibility toward the manufacturer and can support on handling the risk of overstock on the newly introduced product. Change of processes can also result in development. Alignment of processes and strategies can enable operation with lower stock. By this harmonization the parties can also learn from each other and develop themselves.

Manufacturer and distributor are mainly in conflict due to the changing customer need. Regarding planning, strategy and changes both parties should be informed. This transparent communication enables the manufacture to utilize the capacity on a high level that would mean also better level of production cost. With better planning the company driven changes on demand (like price changes, volume deals) can be built in the manufacturer's planning also. This will result in decrease in the level of uncertainty. The harmonization of priorities can also

help. Both sides should be on the same understanding to reach the chain level goal. It can also help on echelon level as the goals and strategy can focus on the appropriate elements.

The distributor has high impact on the customer satisfaction as this member is the face of the company. In most of the cases final demand is highly influenced by strategical decisions (e.g. price) on the distributor side. But demand can also highly differ due to the change of environment and change of customer's needs. To make better service more advanced forecast can support. To get this market estimation surveys or market researches can be done. Based on that the portfolio can be amended to fulfil the customer needs better. The forecast can also be changed so the manufacturer produces also the proper products.

### **3.3 Result – how to use the risks and opportunities to improve**

As a result of the third chapter below checklist can be made that can be a starting point in evaluating the current situation and possible next steps: (a) What KPIs are used currently?, (b) Are the currently used KPIs showing the performance improvement areas on the echelon level?, (c) What is the current way of collaboration used in the supply chain?, (d) What are the potential risks?, and (e) What are the potential opportunities?.

As collaboration needs different methods and levels depending on the circumstances there is no ready to use solution. It is also impossible to generate a tool defining the best solution as too many circumstances needs to be analysed. Going through this checklist is a very basic step which can give a frame for initiating basic changes and to increase cooperation and collaboration to a higher possible level.

## **4 CONCLUSION AND DISCUSSION**

There are several studies checking what measures should be implemented in the different parts of the supply chain. It is very useful to check them and have complete view on possibilities. It is also crucial to use the chain perspective and take advantage of the collaboration in the supply chain. KPIs need to fit to strategy of the echelon but also to the strategy of the connected elements. Collaboration and information need to be used as advantage; it need to be shared on a proper level with the peers to reach competitive advantage. Even in today's competitive environment it is very important to have common understanding of processes. With limiting the information shared and the level of cooperation the reached result is also limited. The value generation perspective is also important to enable all the stakeholder to have full understanding of prioritize and focus areas of the other echelons. This support the harmonization.

This study presented the focus areas of the different supply chain members and some of the connection points and possibilities in the supply chain. The aim was to show that these differences that are obvious based on the echelon level investigation are not only limits and risk factors but also opportunities to grow on a global level. Communication, collaboration and cooperation of different echelons of the chain can result in a fruitful common growth. The difficulty is mainly defining the level of information and knowledge that should be shared. During the collaboration between the members all elements need to be controlled what potential risks and benefits are occurring. It is also important that this check need to be carried out considering the supply chain perspective in the sense that decisions made on a given level can have high impact on a different level.

The presented possibilities highly recommend advanced level of information and knowledge sharing. This process works only in an idealized word. Competition disable the full transparency. The main questions are as follows: (1) What is the level of information that should be shared?, (2) How should the echelons define the elements shared?, and (3) What is the

optimal level where the advantages of the information can be used but the information is not ruining the competitiveness?

These questions can be answered differently industry per industry, product by product and even case by case. The market, competitors and way of working is different. Checking the potential risks and opportunities are always important but implementation will always differ. As an example, different cells and batteries are used in several industry (e.g. TV, e-bike, power tool, phone, etc.). Supplier in this case is likely to supply also the competitor companies/manufacturers. Sharing information here can potentially be a high risk as the supplier may have more transparent communication and collaboration with the rival company. The similar example can be also identified with other products or other members of the supply chain. The crucial point is identifying the level of collaboration that is beneficial for both parties. It worth to question how far the company should go with the cooperation without endangering the position in the market. But the situation can be also checked the other way around. How would a market look like with 100% information and knowledge sharing within the supply chain cooperation?

The decision always needs to be made with awareness for the risks and potentials. In the same time these factors should be identified considering the market and economic circumstances.

## References

- Christopher, M. (2016). *Logistics and Supply Chain Management*. London: Pearson.
- Cousins, P., Lamming, R., Lawson, B., & Squire, B. (2008). *Strategic Supply Management: Principles, Theories and Practice*. Harlow: Prentice-Hall.
- Harrison, A., & Hoek, R. (2008). *Logistics Management and Strategy Competing through the supply chain*. Harlow: Prentice-Hall.
- Huang, A., & Badurdeen, F. (2016). *Framework for Sustainable Manufacturing Performance Assessment at the System Level*. Paper presented at the Industrial and Systems Engineering Research Conference (ISERC 2016), Anaheim, California.
- Huang, A., & Badurdeen, F. (2017). Sustainable Manufacturing Performance Evaluation: Integrating Product and Process Metrics for Systems Level Assessment. *Procedia Manufacturing*, 8, 563-570. doi: 10.1016/j.promfg.2017.02.072
- Lindberg, C. F., Tan, S. T., Yan, J. Y., & Starfelt, F. (2015). Key Performance Indicators Improve Industrial Performance. *Energy Procedia*, 75, 1785-1790. doi: 10.1016/j.egypro.2015.07.474
- Manotas, D. F., & Cadavid, L. R. (2007). Lean manufacturing measurement: the relationship between lean activities and lean metrics. *Estudios Gerenciales*, 23(105), 69-83. doi: 10.1016/S0123-5923(07)70026-8
- Ramanathan, U. (2014). Performance of supply chain collaboration – A simulation study. *Expert Systems with Applications*, 41(1), 210-220. doi: 10.1016/j.eswa.2013.07.022
- Rushton, A., Croucher, P., & Baker, P. (2010). *The Handbook of Logistics and Distribution Management*. London: Kogan.
- Shaban, A., Costantino, F., Di Gravio, G., & Tronci, M. (2019). A new efficient collaboration model for multi-echelon supply chains. *Expert Systems with Applications*, 128, 54-66. doi: 10.1016/j.eswa.2019.03.026



- Sawik, T. (2014). On the fair optimization of cost and customer service level in a supply chain under disruption risks. *Omega*, 53, 58-66. doi: 10.1016/j.omega.2014.12.004
- Thomson, F. (2016). OEE: *The critical KPI to drive manufacturing productivity*. [Video file]. Retrieved from <https://www.youtube.com/watch?v=KB8Zc0UgLWc>
- Waters, D. (2010). *Global Logistics*. London: Kogan.
- Wisner, J. D., Tan, K. C., & Leong, G. K. (2012). *Principles of Supply Chain Management*. Manson: South-Western.

### **Contact information**

#### **Diána Strommer**

Széchenyi István University  
H-9026 Győr, Egyetem tér 1., Hungary  
E-mail: dianastrommer@gmail.com  
ORCID: 0000-0002-4762-0026

doi: 10.7441/dokbat.2019.096

# SHARING CITIES: INFLUENCE OF TIME BANKS ON URBAN DEVELOPMENT

*Dominika Šafrová, Pavlína Hejduková*

## **Abstract**

Nowadays the cities are faced with increasing pressure on economic and ecological systems, infrastructure and other public goods. High population and constantly developing new technology, cities are becoming an important centre point for a new circular economy which is driven by emerging and long-standing sharing activities. One form of sharing in the cities is the time banks. Municipal time banking consists of using time of residents for tasks of public interest and provision of civil resources. This paper looks at the different and common characteristics of sharing economy model in the cities with emphasis on time banks. The main aim of the paper is to determine the influence of time banks on urban development and to find out what time banks bring to the city. There are used several research methods in the paper. Firstly, the description method is used, followed by specific examples and the method of synthesis at the end of the paper. The main results are that time banks can reduce urban costs, support entrepreneurs, develop residents' knowledge and skills and an overall increase in living standards. Data that are used in the empirical part of the paper mostly come from internet resources. Specifically, from the websites of individual time banks.

**Keywords:** *sharing city, sharing economy, time bank, development, community, urban development*

## **1 INTRODUCTION**

Nowadays the cities are the major contributors to environmental problems. For sustainability life in the global economy will need to transition to more sustainable consumption and production systems and it is expected that cities will form part of the solution of this sustainable development. (Cohen & Munoz, 2016)

One important tool for sustainable development is the sharing economy. The sharing economy is the system where individuals can share estate or services. Even though sharing is old as humanity, digital tools expand the possibilities for sharing economy. Just as sharing economy can affect urban development, city authorities can affect the growth of this economic system by support functions. For cities is important to fully exploit the potential of sharing economy and give to residents' possibility to use opportunities and benefits of it. (Eurocities, 2017; Lexico, 2019; WEF, 2017)

According to the research of DuPuis and Rainwater (2017), the main concerns about sharing economy are public safety and protection of ordinary goods or service providers. On the other hand, the most common advantages of sharing economy are better services, economic activity, and business activity. Specifically, the growth of sharing cities could bring benefits like supporting community, simplifying social inclusion, protection of the environment, for example by sharing means of transport. At the city level, goods, spaces, services, and skills of residents, can be shared. (WEF, 2017; DuPuis & Rainwater, 2017)

People nowadays work hard to get everything they need like a car, house, etc. The meet needs of a person are not easy or most efficient through individual ownership. An interesting thing about sharing economy is the ability to exchange unused capacity of resources that already have

owners. It allows people to have things that meet their needs, even if they do not own them. (Allen, 2015; Kassin & Orsi, 2012)

In this world, money is the main exchange unit. The sharing economy brings more options for the exchange. It gives more possibilities to people who do not have enough money. This paper introduces a form of sharing economy – time banks and their influence on urban development. Time banks are based on the ideas of Edgar Cahn from the 1980s. In this system, people exchange time and skill and so they spend and earn time credits. (Cahn & Gray, 2015; Kassin & Orsi, 2012)

This paper includes a theoretical background that is divided into two parts. The first part deals with sharing cities in general and the second part is focused on time banks. A literature review is followed by methodology and results. The content of these parts goes about the development of time banks in selected areas. Examples from the UK, the United States, and the Czech Republic will be presented. The last one is the conclusion summarizing findings of the whole paper and the possibilities of the next research such as the development of time banking in the Czech Republic.

## **2 THEORETICAL BACKGROUND**

The theoretical background consists of two parts. The first is called Sharing cities and includes basic information about the sharing economy at the city level. The second part is focused on a specific form of sharing economy and those are time banks.

### **2.1 Sharing cities**

Urban sustainability can be affected by sharing economy from economic and environmental aspects. From the economic aspect sharing economy reduces costs, affects supply and demand. From the environmental point of view, the efficient use of resources is supported by the sharing economy. This promotes environmental protection. (Wu & Zhi, 2016)

City life is about sharing. Residents share space and exchange commodities and services. The sharing economy can provide cities with access to new opportunities. According to DuPuis and Rainwater (2017) has more than half of cities positive relationship with sharing economy companies like Uber or Airbnb and more than three-quarters would be open to a partnership with a sharing economy company. The development of an urban sharing economy can lead to more efficient use of resources, lower costs, additional earnings and better social relationships. (Greene & McGinty, 2016; Agyeman, McLaren & Schaefer-Borrego, 2013; DuPuis & Rainwater, 2017)

By expanding supply in times of high demand can sharing help to the city. For example, tourist locations can in the main season use sharing economy to get space to accommodate a higher number of tourists. The opposite effect may also occur – supply surplus. One example is bike-sharing in China, where existing assets were not used efficiently. There was an excessive supply of bikes due to the desire to control the market. (WEF, 2017)

The sharing economy helps people who do not have funds by reducing spending. It would be offered the opportunity to use goods or services and save money. Sharing in urban life is not a novelty. As noted, the sharing economy is based on sharing instead of ownership. The development of sharing economy can be influenced by city authorities. The effects that can be applied include, for example, taxation, housing, and land regulation or provision of public information. (Eurocities, 2017; Greene & McGinty, 2016)

As already mentioned sharing economy can help to protect the environment, but it can also have negative consequences. For example, thanks to car-sharing are cars available for more families or individuals. That means an increase of emissions. Sharing can also support race or gender prejudice. In research by Edelman, Luca and Svirsky (2017) was detected that more information facilitates trade but also discrimination. (Schor, 2014; Edelman, Luca & Svirsky, 2017)

According to Cahn (2000), there are two economic systems - market and non-market. Activities related to family or community are not included in the market definition of work. While the non-market system includes raising children, taking care of elders, etc. Non-market activities are associated with community-based organizations. Through time bank people help each other thanks to the use of untapped resources and skills. Help includes activities such as giving lifts to hospital appointments, dog-walking, gardening, etc. Collom (2008) mentions services that are most often exchanged in time banks by the elderly. The list includes health care services, transportation, massage, computer assistance, tickets to events, home repairs, etc. (Collom, 2008; Seyfang, 2006; Cahn, 2000)

## **2.2 Time banks**

There are about a thousand of time banks around the world. Approximately half are located in the United States, which means that the US has probably the largest number of time banks. But we can also find them in the United Kingdom or New Zealand. Neither the Czech Republic remained untouched by time banks. (Brázdová, Mayášová & Rahouz, 2015; Thorpe, 2018)

Time banks are a form of sharing economy based on the community in which services are exchanged for hours. Municipal time banking consists of using time of residents for tasks of public interest and provision of civil resources. Ryan-Collins, Stephens and Coote (2008) mention three models of time banks: (a) person-to-person (P2P); (b) person-to-agency (P2A); and (c) agency-to-agency (A2A).

Person-to-person is an original model of time bank in which members exchange time credits controlled by time broker. In person-to-agency model time credits are earned by helping to fulfil goals of agency or community. It is about services for the public or third sector like planting trees. For example, young people with leisure can do this activity and exchange time credits for a visit to the cinema. Agency-to-agency works alike P2P between individuals. Organizations can share unused assets like empty meeting rooms or down-time of staff. (Schor, 2014; WEF, 2017; Ryan-Collins, Stephens & Coote, 2008)

Even when time banks are all over the world most of them are on a local or regional level. Time bank can exist only temporary or it can exist for years. Also, size is not limited in any way, it can be small and have about 15 members or it can be large and have more than three thousand members. (Cahn & Gray, 2015)

The biggest problem this form of sharing economy faces is that people do not understand the difference between time banking and volunteering. Probably because no physical currency is used and social services are the main focus of time banks. The main difference between time banking and volunteering is that members of the time banks give and receive. (Collom, Lasker & Kyriacou, 2012; Seyfang, 2004a)

Figure 1 below shows the sharing options for cities that were already mentioned. Except sharing of goods and spaces, there is a possibility to share through time banks. It should specifically explain how time banks work. For example, Jack does gardening for John for one hour. Jenny needs a ride to the hospital because after consultation at the doctor she cannot drive so she does

dog-walking for Jack and earn one hour. John rides her to the hospital and uses his hour to home repairs.

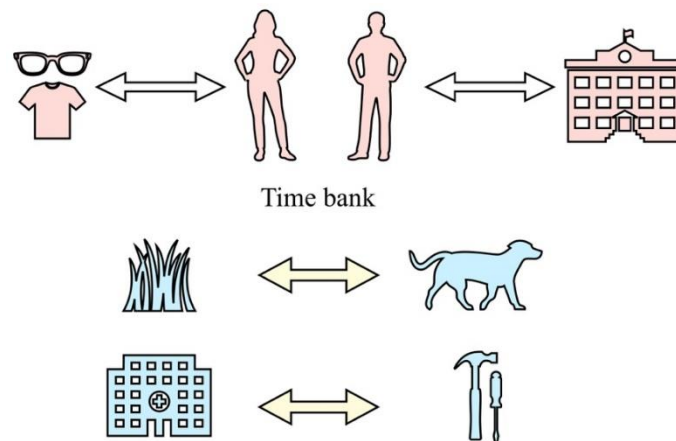

Fig. 1 – Sharing city. Source: Seyfang (2006), Agyeman, McLaren & Schaefer-Borrego (2013)

Time banks can contribute to city development by raising the flexibility of the labour market, supporting social inclusion and connection or reducing dependence on money. The world has more capacity than the market defines. Forms of sharing economy like time banks can raise the flexibility of the labour market by underemployed helping people who need work to be done. Time banks provide assets that people and organizations can offer, specifically, knowledge, skills, time, etc. (Woskowiak, 2014; Ryan-Collins, Stephens & Coote, 2008; Timebanking UK; 2019)

Family and friends can live far away and nowadays everyone does not have a close relationship with their neighbours. As already mentioned through time banks people exchange their skills, so they can help each other without using money. This form of sharing economy can bring people together. Everyone can be part of a time bank from individuals to organizations. Interest in time banking can be fulfilled by joining an existing time bank that already has its members. Another possibility is to establish a new time bank and ask people to become part of it. (Timebanks USA, 2019; Timebanking UK, 2019)

Time banks can be used as a tool for supporting social inclusion and social connection. Marginalized people and passive acceptors of services could through time banks feel that their time is valuable. Raising children or helping a neighbour are needed although the market economy does not value these activities which are important for the non-market economy and community development. (Seyfang, 2004a; Seyfang, 2004b, Schor, 2014)

There are many reasons to be a part of time banks. Members can get services that they could not afford or could not execute by themselves. People can use this form of sharing economy to secure services or goods for which they do not want to pay. It is an opportunity to improve personal value and confidence. The development of time banks can lead to the use of capabilities that would not normally be used. (Collom, Lasker & Kyriacou, 2012)

The advantage of time banks is the use of time as a currency, which can help reduce dependence on money to get things and services. Time credits which members of time bank get means that they can purchase and that their work is not without reward. The value of labour is determined by how long it takes, which means that one hour of someone's work is always equal to another's. For time banks has every person skill to provide. (Gregory, 2009; Collom, Lasker & Kyriacou, 2012; Ryan-Collins, Stephens & Coote, 2008; Cahn & Gray, 2015)

### 3 METHODOLOGY

This paper deals with the development of time banks. The main goal is to find out what banks bring to city development. The theoretical background was created by the method of description. The first part focuses on sharing cities and what can be shared. It also mentions what sharing can bring to cities. Specifically, what can bring the development of time banks? The following section defines time banks, lists their types and describes how they work.

Results contain specific examples of time banks and the projects they run. It also includes the number of time banks in selected countries using a web system that provides hOurworld. Time bank using this system has appeared in the Czech Republic. For this reason, areas in which time banks use this system were selected. Overview of the number of time banks using it includes California, United Kingdom, France, Spain, Italy, Estonia, and New Zealand.

Examples were selected from the field of time banks using the same system as in the Czech Republic, and an overview of the number of time banks in selected countries shows that the system is spread worldwide. After the selection of representatives from California and the UK is revealed the development of time banks in the world including the case from the Czech Republic.

The projects and the purpose of each are described. At the end of the paper is used a method of synthesis and conclusions are drawn from the findings. The main reason for mentioning the case from the Czech Republic is to point out that even here time banking has developed in some way.

### 4 RESULTS

According to the research of Booth (2015), 45% of members did not give their time to others before time banking. This form of sharing economy supports relationships and 60% of people said that their social contact increased. (Booth, 2015)

Tab. 1 – Time banks. Source: Timebank MUNI (2019)

Country	Number of time banks
California	26
United Kingdom	7
France	10
Spain	5
Italy	9
Estonia	2
New Zealand	4

Online time banks need a web system. Founders can use time bank software providers or create their own. One of the organizations providing Timebank software is hOurworld from Portland, USA. The system includes everything needed like news or referrals. Nowadays hOurworld caters more than three hundred of communities. (Brázdová, Mayášová & Rahouz, 2015; Timebank MUNI, 2019)

Table 1 above shows the approximate number of time banks in selected countries included in the community list on the hOurworld website. Most time banks using this software are located in the United States of America, which is represented in the table by California to show the difference in numbers of time banks. The main reason may be that it is an American organization. Several examples have been selected to illustrate how time banks operate in the world, and specific cases have been described. All of the representatives use the software provided by hOurworld. Selected was a time bank that is situated in the UK and one in California. Also, the case from the Czech Republic is mentioned. (Timebank MUNI, 2019)

Rushey Green Time Bank in the UK has a lot of projects. One of them is called Time Banking with Macmillan. In collaboration with Macmillan Cancer Support, it helps people affected by cancer. According to the member's experience, people will get someone to listen and do work like gardening or housework for them. Another time bank project is FoodCycle Lewisham. Working with FoodCycle brings the possibility to reduce food waste. Once a week, local people can come and eat a meal from excess food. This project brings a reduction in food waste and connects local people. Lewisham Local Card ensures that money is spent in the local economy thanks to benefits for cardholders like discounts, free drinks or meals, free entry, etc. The advantages are provided by local shops and businesses.

Time banks can bring many advantages to cities. Rushey Green Time Bank supports local people. Whether it be support for sickness, better relationship or support for local entrepreneurs. In addition to improving relationships, this form of sharing economy provides an opportunity to use Lewisham Local Card. Support of local entrepreneurs can bring many benefits. Participants in time banking are directed to purchase from them thanks to advantages. This tool can help local entrepreneurs make their business prosper. (Rushey Green Time Bank, 2019; Lewisham Local, 2019)

Arroyo S.E.C.O. Network of Time Banks in Los Angeles is the second chosen representative. One of its projects is called Fruit Harvest, which has many benefits such as promoting locally grown food, reducing food waste, sharing harvest surpluses. Members of an organization can gain experience in tree care and then offer new skills to others. Service is helpful especially to people who provide their trees for harvest. Dog Cooperative is another project of California time bank which is related to dog care. Members without pets can use this project to earn time credits. It is not only about dog walking, but also for example training. (ASNTB, 2019)

Arroyo S.E.C.O. Network of Time Banks supports the development of people who have the opportunity to acquire new knowledge and experience through the projects they run. Project Fruit Harvest can benefit the environment through experience, people can maintain trees in their garden or buy them. Benefits can also be seen in the Dog Cooperative project. Nowadays, many people have dogs, but they do not manage time-consuming training, which can prevent the escape of a dog from home. It is logical that dog training significantly reduces the probability of trouble, which is also advantageous for a city that does not have to deal with catching a dog. (ASNTB, 2019)

The Czech Republic was also affected by the development of time banks. For example, Masaryk university students founded Timebank MUNI for their classmates in 2015. They wanted to try for themselves how it could work at the university. After checking people's interest in this project via Facebook, the web system has been activated. For example, students offered interviews in different languages, control of citations in academic papers, help with Excel, etc. After one and a half months, 65 hours were exchanged.

Timebank MUNI still can be found in the web system provided by the organization hOurlworld. The May 2016 news section mentions that offers are no longer up-to-date and organizers no longer care about the web. The project is no longer running, but it is still possible to get involved and see the system.

Project in the Czech Republic could make school years easier for students. Time bank could expand their possibilities. Opportunity to receive tutoring without the need for money. They can gain new knowledge and skills such as language skills or playing an instrument. In general, time bank can help students develop. Time banks can help students prepare for their first job. This can support the qualification of new graduates. (Brázdová, Mayášová & Rahouz, 2015; Strnadová, 2015; Timebank MUNI, 2019)

According to the specific examples above, time banks can influence the development of the city. Projects of three selected time banks (Rushey Green Time Bank, Arroyo S.E.C.O. Network of Time banks, Timebank MUNI) affect the qualifications and relationships of the residents, city costs and local business.

Based on the above examples, time banks can expand the skills and knowledge of city residents. Time banks allow people to acquire, for example, language or computer skills. The possibility of accessing new skills can make life much easier for city inhabitants. Acquired skills and experience can be used for themselves. The side effect is to encourage the further development of time banks as members will be able to offer new services.

Entrepreneurs can also get support through this form of sharing economy. Time bank members can receive certain benefits for their services that can bring more customers to local business owners. In addition to new customers, entrepreneurs have the chance to win loyal customers returning to stores. Prosperous businesses can bring new jobs and better services to the city's inhabitants.

This form of sharing economy can help the city reduce costs. Time banking can be focused on preventing city costs. This can be achieved by offering services that prevent these costs. The city can also use the services of citizens for public activities. In addition to the example of preventing the costs of catching dogs, an example of tree planting is mentioned in the subchapter Time banks.

## **5 CONCLUSION**

Time banks can raise living standards. This form of sharing economy develops the knowledge and skills of the residents, support local entrepreneurs and cities can achieve lower costs. These consequences of time banking can bring development to the city and its inhabitants. Based on the examples above, it has been found that time banking has an impact on the development of the city.

Subchapter Sharing cities states that according to Greene and McGinty (2016) development of sharing economy can lead to more efficient use of resources, lower costs, additional earnings and better social relationships. Seyfang (2004a; 2004b) also mentions the idea of better social relationships. Specifically, as mentioned in the subchapter Time banks, time banks can be used as a tool for supporting social inclusion. Based on results this can be confirmed. A selected form of a sharing economy (time banks) can achieve these benefits through projects such as Time Banking with Macmillan, Food Cycle Lewisham, Lewisham Local Card, Fruit Harvest or Dog Cooperative.

Wu and Zhi (2016) conclude that a sharing economy can affect supply and demand. According to the World economy forum (2017) city can expand supply using sharing economy. The effects on supply and demand can be confirmed. Low-income people gain access to services without using money. They get the opportunity to use the money for other things, which may affect demand. Thanks to the abilities and skills that people acquire through time banks, they can offer additional services through this form of sharing economy. Time banks offer to residents and the city itself extended opportunities in the use of services, which can be considered as an extension of the supply.

Subchapter Time banks mention according to Woskow (2014) that time banks can raise the flexibility of the labour market by underemployed helping people who need work to be done. Time banking is mainly about time. People who have time can use their skills and become part of time banking. Time bank members can acquire new skills and offer more services. People



with low income can earn time credits and use them for services they cannot afford. Those with a lack of time can use others for activities that they do not manage in their free time.

Further research may focus on the reasons why time banking in the Czech Republic has not developed much and how it could develop. Furthermore, what could also be the contribution of time banking and what else could contribute to urban development.

### **Acknowledgment**

This paper was created within the project SGS-2017-004 'Finance and Sustainable Development from the Perspective of Theory and Practice' at the University of West Bohemia, Faculty of Economics.

### **References**

- Agyeman, J., McLaren, D., & Schaefer-Borrego, A. (2013). *Sharing cities*. Retrieved from [https://friendsoftheearth.uk/sites/default/files/downloads/agyeman\\_sharing\\_cities.pdf](https://friendsoftheearth.uk/sites/default/files/downloads/agyeman_sharing_cities.pdf)
- Allen, D. (2015). The sharing economy. *Institute of Public Affairs Review: A Quarterly Review of Politics and Public Affairs*, 67(3), 24-27. Retrieved from [https://ipa.org.au/wp-content/uploads/archive/IPA\\_Review\\_Vol67\\_3\\_September2015\\_hires\\_ALLEN\\_sharing\\_economy.pdf](https://ipa.org.au/wp-content/uploads/archive/IPA_Review_Vol67_3_September2015_hires_ALLEN_sharing_economy.pdf)
- ASNTB (2019). *Arroyo S.E.C.O. Network of Time Banks*. Retrieved from [www.asntb.com](http://www.asntb.com)
- Booth, B. (2015). *Spice Impact Measurement: Talking the Talk and Walking the Walk*. Retrieved from [https://socialcurrency.sciencesconf.org/conference/socialcurrency/pages/Spice\\_Impact\\_Measurement.pdf](https://socialcurrency.sciencesconf.org/conference/socialcurrency/pages/Spice_Impact_Measurement.pdf)
- Brázdová, M., Mayášová, L., & Rahouz, V. (2015). *Časové bankovníctví: Recyklujte svůj čas*. Retrieved from <https://web2.mlp.cz/koweb/00/04/23/36/30/casove-bankovnictvi-recyklujte-svuj-cas.pdf>
- Cahn, E. S. (2000). *No more Throw-away People: The Co-production Imperative*. Washington: Essential Books.
- Cahn, E. S., & Gray, C. (2015). The Time Bank Solution. *Stanford Social Innovation Review*, 13(3), 41-45. Retrieved from [https://ssir.org/articles/entry/the\\_time\\_bank\\_solution](https://ssir.org/articles/entry/the_time_bank_solution)
- Cohen, B., & Munoz, P. (2016). Sharing Cities and Sustainable Consumption and Production: Towards an Integrated Framework. *Journal of Cleaner Production*, 134 (Part A), 87-97. doi: 10.1016/j.jclepro.2015.07.133
- Collom, E. (2008). Engagement of the Elderly in Time Banking: The Potential for Social Capital Generation in Aging Society. *Journal of Aging & Social Policy*, 20(4), 414-436. doi: 10.1080/08959420802186282
- Collom, E., Lasker, J. N., & Kyriacou, C. (2012). *Equal Time, Equal Value: Community Currencies and Time Banking in the US*. Franham: Ashgate.
- DuPuis, N., & Rainwater, B. (2017). *Cities and the Innovation Economy: Perception of Local Leaders*. National League of Cities: Center for City Solutions. Retrieved from <https://nlc.org/sites/default/files/2017-11/NLC%20Cities%20and%20Innovation%20Economy.pdf>

- Edelman, B., Luca, B., & Svirsky, D. (2017). Racial Discrimination in the Sharing Economy: Evidence from a Field Experiment. *American Economic Journal: Applied Economics*, 9(2), 1-22. doi: 10.1257/app.20160213
- Eurocities (2017). *Sharing cities: a sharing economy that delivers benefits for citizens*. Retrieved from <http://nws.eurocities.eu/MediaShell/media/EUROCITIESsharingeconomy policypaper March2017final.pdf>
- Greene, S., & McGinty, J. (2016). *What if Cities Could Create a Truly Inclusive Local Sharing Economy?* Retrieved from [www3.weforum.org/docs/White\\_Paper\\_Collaboration\\_in\\_Cities\\_report\\_2017.pdf](http://www3.weforum.org/docs/White_Paper_Collaboration_in_Cities_report_2017.pdf)
- Gregory, L. (2009). Spending Time Locally: The Benefit of Time Banks for Local Economies. *Local Economy: The Journal of the Local Economy Policy Unit*, 24(4), 323-333. doi: 10.1080/02690940903026852
- Kassan, J., & Orsi, J. (2012). The Legal Landscape of the Sharing Economy. *Journal of Environmental Law & Litigation*, 27(1), 1-20. Retrieved from <https://core.ac.uk/download/pdf/36686879.pdf>
- Lewisham Local (2019). *Lewisham Local*. Retrieved from [www.lewishamlocal.com/card](http://www.lewishamlocal.com/card)
- Lexico (2019). *British & World English: Definition of sharing economy*. Retrieved from [https://www.lexico.com/en/definition/sharing\\_economy](https://www.lexico.com/en/definition/sharing_economy)
- Ryan-Collins, J., Stephens, L., & Coote, A. (2008). *The new wealth of time: How timebanking helps people build better public services*. Retrieved from <https://nwi.pdx.edu/webinars/Webinar13-materials1.pdf>
- Rushey Green Time Bank (2019). *Rushey Green Time Bank*. Retrieved from [www.rgtb.org.uk](http://www.rgtb.org.uk)
- Schor, J. (2014). Debating the Sharing Economy. *Journal of Self-Governance and Management Economics*, 4(3), 7-22. doi: 10.22381/jsme4320161
- Seyfang, G. (2004a). Time banks: Rewarding community self-help in the inner city? *Community Development Journal*, 39(1), 62-71. doi: 10.1093/cdj/39.1.62
- Seyfang, G. (2004b). Working Outside the Box: Community Currencies, Time Banks and Social Institutions. *Journal of Social Policy*, 33(1), 49-71. doi: 10.1017/S0047279403007232
- Seyfang, G. (2006). Harnessing the Potential of the Social Economy? Time Banks and UK Public Policy. *International Journal of Sociology and Social Policy*, 26(9/10), 430-443. doi: 10.1108/01443330610690569
- Strnadová, H. (2015). *Na Masarykově univerzitě je možné obchodovat s časem*. Retrieved from <http://www.munimedia.cz/prispevek/na-masarykove-univerzite-je-mozne-obchodovat-s-casem-8685/>
- Thorpe, D. (2018). *Time Banking Helps Build Individuals, Organizations And Communities*. Retrieved from <https://www.forbes.com/sites/devinthorpe/2018/03/21/time-banking-helps-build-individuals-organizations-and-communities/#40a060e65ba4>
- Timebank MUNI (2019). *Timebank MUNI*. Retrieved from <http://www.hourworld.org/bank/?hw=1482>
- Timebanking UK (2019). *Timebanking UK*. Retrieved from <https://www.timebanking.org>

- Timebanks USA (2019). *Timebanks USA: About timebanking*. Retrieved from <https://timebanks.org/timebankingabout/>
- WEF (2017). *Collaboration in Cities: From Sharing to 'Sharing Economy'*. World Economic Forum. Retrieved from [www3.weforum.org/docs/White\\_Paper\\_Collaboration\\_in\\_Cities\\_report\\_2017.pdf](http://www3.weforum.org/docs/White_Paper_Collaboration_in_Cities_report_2017.pdf)
- Woskow, D. (2014). *Unlocking the sharing economy: An independent review*. Retrieved from <https://apo.org.au/sites/default/files/resource-files/2014/11/apo-nid221891-1334636.pdf>
- Wu, X., & Zhi, Q. (2016). Impact of Shared Economy on Urban Sustainability: from the Perspective of Social, Economic, and Environmental Sustainability. *Energy Procedia*, 104, 191-196. doi: 10.1016/j.egypro.2016.12.033

### Contact information

**Bc. Dominika Šafrová**

University of West Bohemia, Faculty of Economics  
Univerzitní 8, 30100, Pilsen, Czech Republic  
E-mail: [dsafrova@students.zcu.cz](mailto:dsafrova@students.zcu.cz)  
ORCID: 0000-0003-1694-8528

**Ing. Pavlína Hejduková, Ph.D.**

University of West Bohemia, Faculty of Economics  
Univerzitní 8, 30100, Pilsen, Czech Republic  
E-mail: [pahejdu@kfu.zcu](mailto:pahejdu@kfu.zcu)  
ORCID: 0000-0003-3387-1198

doi: 10.7441/dokbat.2019.097

# POSSIBILITIES OF DETECTING FRAUD IN FINANCIAL STATEMENTS WITH FOCUS ON ANALYTICAL METHODS OF EVALUATING FINANCIAL STATEMENTS

*Jaroslava Šepel'ová*

## **Abstract**

The aim of this paper is to point out the seriousness of the consequences of fraud in accounting. We focus on the financial and non-financial motivational factors that are responsible for the decision to commit accounting fraud. However, our attention is mainly focused on the detection of accounting fraud. Based on the studied literature, we classify individual forms of detection of these frauds which are divided into analytical methods, methods using red flags, statistical and data mining methods and behavioural methods. We pay increased attention to the application of analytical methods to the environment of small and medium-sized Slovak companies, as these companies are not subject to audit obligations and controls on their accounts are performed to a very low extent. Therefore, the possibility of detecting fraud in their accounts is considerably limited. We applied Kanapickiene - Grundiene and Persons models. Application of these methods to Slovak companies created a picture of the probability of fraud in the financial statements. Despite the limitations that the models were created under different geo - economic conditions, their use generally shows that the probability of fraud in the financial statements of Slovak companies is more than 50%. The differences between probabilities occur mainly in individual regions and business sectors. The results of this application clearly underline the need to pay increased attention to fraud in the financial statements of small and medium-sized enterprises.

*Keywords: accounting, accounting fraud, analytical methods, Slovak companies*

## **1 INTRODUCTION**

Accounting is the fundamental source of information in the company assessment. It is the most important source of information for the company management itself, for auditors, analysts and for state institutions as well. At the same time, the profit / loss as the final result of the economic activity of the company is a part of the corporate income tax return. All of the company's transactions will inevitably be viewed in the accounts and because of that they will have an impact on profit or loss and on the tax base, too. Fraud, creative accounting and accounting errors unfavourably affect all its users and have a significant impact on the tax liability and on making decisions about further indebtedness of the company. Therefore, it is appropriate to consider the motivation of companies to report false information in their accounts and, on the basis of this understanding, to invest attention to possibilities of detection of fraud in accounting.

We focus our attention mainly on small and medium-sized enterprises which are the driving force (not only) of the Slovak economy. Their functioning has an irreplaceable sense of public finances, the competitiveness of the economy and job creation. Nevertheless, little attention is paid to the correctness of their accounts and financial statements. We also consider the fraud in the financial statements to be very serious in terms of possible controls and audits. The audit of accounts that is currently carried out mainly by audit firms is not focused on small and medium-sized companies, as the condition for auditing the financial statements is predominantly for large companies that meet the statutory defined criteria. The second option of accounting

control is the control that is implemented by the Financial Administration of the Slovak Republic. However, the number of controls focused on entrepreneurial accounting ranges between 0.5-4.6% of all entrepreneurial controls. Therefore, it is clear that there is a high probability of not revealing manipulation and fraud in the accounts of small and medium-sized enterprises.

## **2 LITERATURE REVIEW**

Knowledge of the definitions, indicators and motivational elements of frauds in financial statements significantly condition detection of fraud itself. Therefore, it is appropriate to define fraud and error in general, but also in the context of financial reporting. The error is an unintentional act of an individual (Albrecht, Albrecht & Albrecht, 2003), with no aim being pursued by that act. On the other hand, according to Singleton et al. (2006), fraud has several definitions. It includes all the diverse activities that human resourcefulness can pursue to gain an advantage. According to Kwok and Sharp (2005), incorrectly declared facts in the financial statements may only arise due to error or fraud. He characterizes the error in the financial statement as unintentionally incorrect financial statements. Discrepancy like this may result from an error that happened during the process of data collection or processing, misinterpretation of facts, or an error in the classification, presentation and disclosure of financial statements. In addition to fraud and error, the concept of 'creative accounting' must also be defined. This term is quite common and its characteristic lies in searching for legal ways within the legislation governing accounting procedures. Creative accounting and accounting fraud cannot be confused. Fraud in accounting is a deliberate violation of legislative rules, while creative accounting uses legal options to circumvent the rules.

### **2.1 Motives of fraud in financial statements**

Fraud in the financial statement is one of the types of corporate fraud and relate to situations where the financial statements contain a distortion of essential facts. Financial reporting frauds could also be described as management frauds, because in most cases, it is clear that management has also been involved in fraud of this magnitude (Goel & Gangolly, 2012; Brennan & McGrath, 2007; Wells, 2004). Elliot and Willingham (1980) also consider financial statement frauds to be management frauds, and therefore fraud in the financial statements is a deliberate activity of managers that harm investors and creditors through misleading financial statements. Fraud in accounting is the result of intentional activity that pursues the goal that the manager or the person responsible for accounting wants to achieve. Based on the author's thoughts, these goals or motivational factors can be divided into 2 groups: financial and non-financial goals.

The tax evasion is based on the author's thoughts one of the motivating elements of reporting fraudulent financial statements. Shackelford and Shevlin (2001) reported in their work that much research of fraudulent reporting to reduce tax liability is not adequate. However, there are several authors who studied this motivational factor of fraudulent reporting. Harris (1993) was one of the first authors who studied the issue of manipulating accounting for tax fraud. He stated that management deliberately manipulates sales and expenses to keep the tax liability as low as possible. Similarly, Guenther (1994) studied this issue, particularly fraudulent reporting of company costs in an effort to reduce tax liabilities.

An important financial motive to commit manager frauds in reporting is the financial motivation of managers themselves. Management, as well as other employees, are under a lot of pressure if the company's success is directly linked to their valuation. This may lead managers to choose the way of the fraudulent reporting (Jones, 2011). Albrecht, Albrecht and Albrecht (2003) found

that one of the main motives for the emergence of a large number of frauds are incorrectly placed performance incentives. An important financial factor that motivates fraudulent reporting is the need to raise funds. Dechow, Sloan and Sweeney (1996) found that the effort to attract external financing at low cost and the desire to avoid constraints of debt contract can motivate management to manipulate revenue.

The authors are dealing with the topic of fulfilling analysts' expectations and forecasts that can often lead management to frauds in accounting (Rezaee, 2010). In the authors' opinions on the motivation of subjects to fraudulent reporting, there is often an effort to conceal unfavourable financial results of the company. Rosner (2003) found that failing firms may be motivated to participate in fraudulent financial reporting to hide their financial difficulties. Beasley et al. (2010) identified the confidentiality of the deteriorating financial situation of the company as one of the most common causes of fraud in the financial statements. Despite different opinions on the motivation of managers or other employees of the company, the authors agreed that the goal of tax policy supposed to be effective detection of fraud and ultimately, prevention of this activity, as well.

The process of verifying truthfulness of the information stated in the accounts can be realised by means of an audit, resp. tax control. These institutes can ensure a thorough and detailed investigation of the company's financial situation. A broader view of fraud detection in financial statements can be found in scientific theory. Although many authors incline to the option that accounting fraud is difficult to detect because it is committed by highly motivated and qualified individuals (Wang, Winton and Yu, 2010; Coenen, 2008), there is a wide range of methods and approaches to detect accounting fraud in financial statements. Based on the examined literature, approaches to fraud detection in financial statements can be divided into four groups: analytical methods, methods based on the use of warning signals, methods using statistical and datamining procedures, methods related to behavioural economics.

## **2.2 Methods of detecting fraud in financial statements**

Analytical methods can be defined as “evaluation of financial information using analysis of the credible relationship between financial and non-financial data” (ISA 520). Analytical methods are assessing the subject's risk, the likelihood of fraud and a comprehensive evaluation of information. Models based on analytical methods can be generally divided into two groups, namely models containing only quantitative information and models linking quantitative and qualitative information. An important analytical model was model by Bell and Carcello (2000). The result of their logistic regression model was a higher likelihood of detection of fraud in the financial statements than the auditor or any other independent auditor is able to detect. They created their model on a group of 77 companies where fraud was detected and by 305 companies without fraud detection. Spathis, Doumpos and Zopounidis (2002) developed a model that uses logistic regression to identify the factors associated with accounting fraud. Chen and Sennetti (2005) applied a model of logistics regression to a sample of 52 IT firms that were accused of fraud in accounting and found that the model achieved an overall correct prediction rate of up to 91%. Dechow et al. (2011) studied 2,190 accounting records audited between 1982 and 2005 and identified firms with poor quarterly or annual economic results. They examined their financial performance, non-financial information, off-balance sheet activities and market measures to identify irregularities. They developed a logistic probability known as the F-score.

Red flags are defined as conditions or circumstances indicating potential fraud (Moyes & Hasan, 1996; Alleyne et al., 2010). They can also be defined as "a set of circumstances that are unusual in nature or differ from normal activities" (Hancox, 2007). Weisenborn and Norris (1997) applied 86 selected warning signals to 30 known cases of fraud and found their presence in most cases. The positive side of the warning signals is the possibility to create an accurate

list for data collection and control, by creating a so-called checklist. However, this checklist may be misleading and attenuating their own activity in identifying risk factors for the auditor, respectively another controller (Moyes & Hasan, 1996). Seow (2009) tested the effectiveness of the checklist in assessing the risks of financial statements. He found from the results that general decision-making tools, such as the use of flag checklists, may be useful, but only for less experienced people.

The main idea of statistical and data mining methods is using accounting databases to look for anomalies, unusual and unexpected relationships (Albrecht, Albrecht & Albrecht, 2003). The results of the studies show that decision trees and neural networks can be used to timely identification of potentially incorrect behaviour. Zhou and Kapoor (2011) proposed a new framework for detecting fraud in financial reporting. Their model included two stages. In the first stage, they used relevant external and internal variables that differentiated according to industry, economic conditions, management choice, timing and other factors that have the potential to generate knowledge about potentially risky behaviour. During the second stage, they analysed the financial data of the company that were ascertained during the first stage. After that, they used the Response Area Method (RSM) to estimate relationships between variables and accounting fraud methods. This system provides statistically validated predictive models.

Methods based on behavioural and experimental economics in the fraud detection and therefore in detection of fraud in the financial statements, too, are widely used. They include the Cressey fraud model, which was created by Cressey as a criminalist and became known as the Fraud Triangle Model. The first side of the fraud triangle represents the pressure or motive of committing fraud, the second side represents a perceived opportunity, and the third side represents rationalization (Wells, 2004).

### 3 DATA AND METHODOLOGY

The aim of this paper is to apply analytical forms of fraud detection in financial statements to the environment of small and medium-sized companies in the Slovak Republic. The application of analytical forms of fraud detection in accounting can provide an indicative picture of the probability of fraud in accounting. We used two different models for the application, the Kanapickiene-Grundiene model and the Persons model.

Both models use logistic regression to determine the likelihood of fraud in the financial statements. Kanapickiene and Grundiene (2015) identified in their study The Model by Fraud Detection in Financial Statments by Means by Financial Ratios 6 significant financial indicators, by using their logistic models it is possible to calculate the probability of fraud in the financial statements as:

$$P = \frac{1}{1 + e^{5,768 - 4,263 \times \frac{INV}{TA} - 0,029 \times \frac{SAL}{FA} - 4,766 \times \frac{TL}{TA} - 1,936 \times \frac{CACH}{CL}}} \quad (1)$$

where  $INV / TA$  is the ratio of inventories to total assets,  $SAL / FA$  - the ratio of sales to total assets,  $TL / TA$  - the ratio of total liabilities to total assets,  $CACH / CL$  - the ratio of cash to short-term liabilities. The resulting value shows the probability of the company committing fraud in the accounts. Persons (2011) also used logistic regression in her study. Her model of estimation of the probability of fraud in the financial statements is as follows:

$$P = 1,3935 + 2,7837(TLTA) + 1,8746 (CATA) - 0,6807 (SATA) - 0,2418(LOGTA) \quad (2)$$

where TLTA = total liabilities divided by total assets, CATA = current assets divided by total assets, SATA = sales divided by total assets, and LOGTA = log of total assets.

We applied information for the calculation of probable false data in the financial statements to the financial statements of all small and medium-sized enterprises in the Slovak Republic on years 2014-2018, broken down by regions, types of companies and business sectors. We analyzed a total amount of 130,000 small and medium-sized companies. The selection criteria for small and medium-sized enterprises were selected from the European Commission Recommendation No 2003/361 / EC. And so they are companies with up to 249 employees, turnover up to 50 mil. EUR and balance sheet up to 43 mil. EUR, at least two of the three criteria must be met. The information needed for the calculation were acquired from the database of company FinStat. The data in this database come from the Register of Financial Statements operated by the Financial Administration of the Slovak Republic. The complete database was supplemented by the legal form, which the companies enter in the Commercial Register of the Slovak republic upon their establishment. Individual statistics were based on median values. The companies were compared on the basis of their legal form, region and business sector.

#### 4 RESULTS AND DISCUSSION

Application of the created fraud detection models in the financial statements provides a basic picture of the potential amount of fraud. We applied the Kanapickiene-Grundiene model and the Persons model to the conditions of Slovak companies in the following section. In addition to the general view of companies, we tested the model on companies in terms of their affiliation to sectors, territorial breakdown and legal form. The general evolution of the two studied models is different. For the Kanapickiene-Grundiene model, the likelihood of fraud in accounting is increasing steadily between 2014 and 2018. Evolution of the probability is different for the Persons model. In terms of legal forms, we divided the companies into four traditional forms of trading companies: Limited Liability Company, Joint Stock Company, public commercial company and limited partnership (we do not consider a simple company for shares, since the possibility of incorporation of this particular legal form is only possible in Slovakia since 2017).

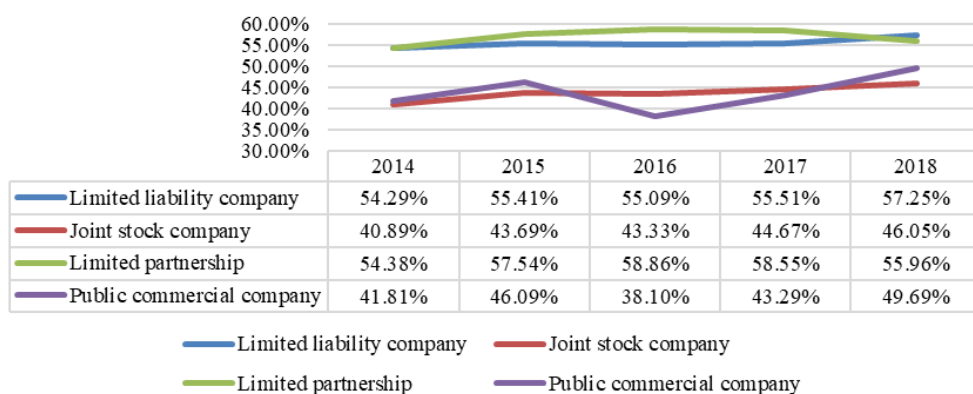

Fig. 1 – Kanapickiene-Grundiene model (divided by legal form). Source: own research

The application of the Kanapickiene-Grundiene model to assess the probability of fraud in the financial statements indicates that limited liability companies and limited partnerships are most likely to commit fraud. The values of probability for public limited companies and public commercial companies evolved similarly throughout the reporting period and are lower than for other types of companies.



In the applications of the Persons model we found slightly different results. It identified the companies most likely to go into bankruptcy to be public commercial companies and limited partnerships, while that the probability in measured models reaches almost the same values. Limited partnerships are, according to both models, the companies most likely to commit accounting fraud. Unlike the Kanapickiene-Grundiene model, the probability measured by the Persons model is higher by up to 10 - 20% in all reporting years and all legal forms.

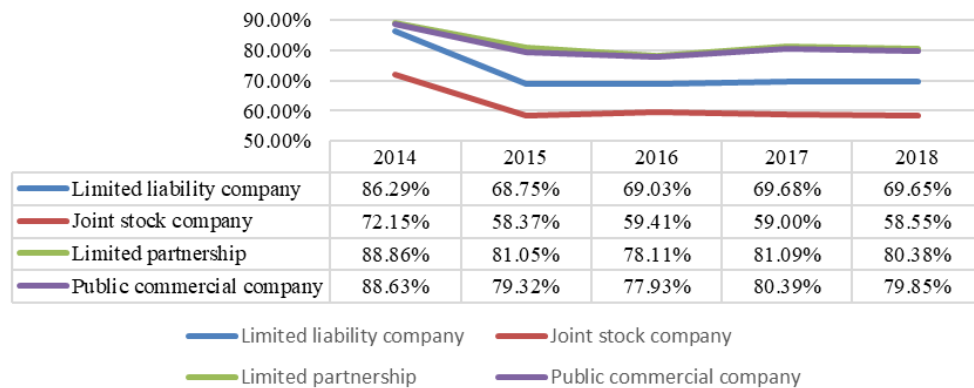

Fig. 2 – Persons model (divided by legal form). Source: own research

The geographical affiliation of individual companies may also be an interesting factor considering frauds in the financial statements. Therefore, it is interesting to look at the results of the application of models to Slovak companies from the perspective of individual regions. Kanapickiene-Grundiene model shows that since 2014 the probability of committing fraud in the accounts has increased in individual regions. Companies in the Košice and Nitra regions have the highest probability of fraud, while companies in the Žilina and Trenčín regions have the lowest probability.

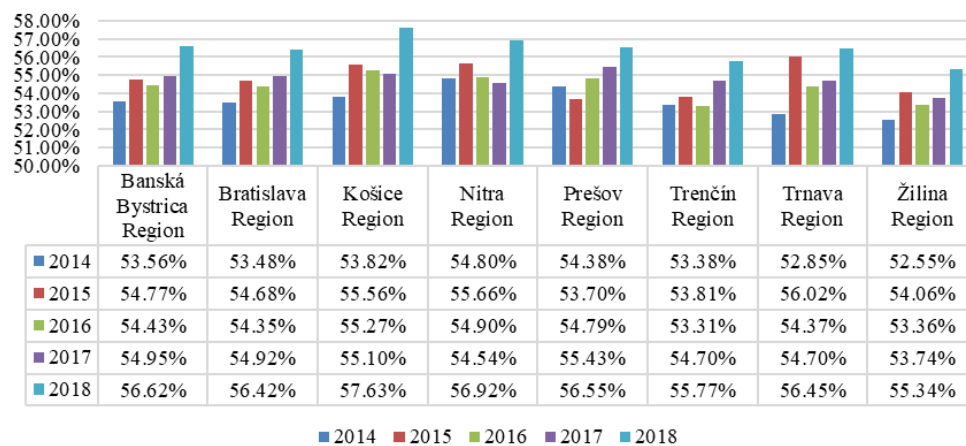

Fig. 3 – Kanapickiene-Grundiene model (divided by region). Source: own research

Persons model shows the opposite trend in the division of companies based on the region, namely a slight decrease in probabilities. The situation in individual regions is very similar, with slightly above-average results being achieved by the Nitra and Trnava regions. The results of the application of the models to Slovak companies showed a different evaluation of companies in individual sectors. Kanapickiene-Grundiene defines the model as the most risky sectors the retail, wholesale and vehicle sales and maintenance sectors in terms of probability of fraud in the financial statements. In contrast, Persons model identified the agriculture, brokerage and retail sectors as the most likely to commit fraud.

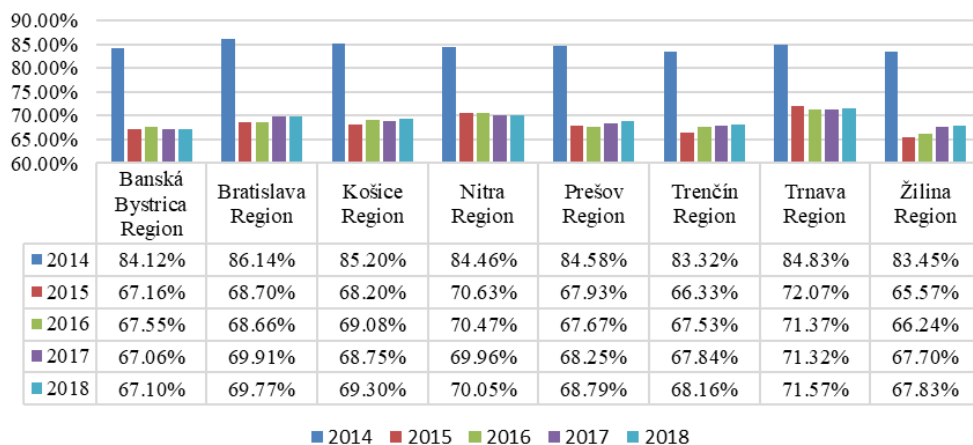

Fig. 4 – Persons model (divided by region). Source: own research

Kanapickiene-Grundiene model considers sectors with the least probability of risky behaviour in the financial statements consider to be the energy and mining sector, real estate and agriculture. Persons model identified transport, health and tourism sectors as the sectors with the least probability of fraud in the financial statements.

## 5 CONCLUSION

Accounting is the basic source of information about the financial situation of the company. It is an irreplaceable source of decision-making knowledge for its users. However, its authenticity is often undermined by the effect of financial and non-financial motives. Based on the studied literature, we identified four basic possibilities of fraud detection in the financial statements, namely analytical methods, red flag methods, behavioural and datamining methods.

Our attention was paid mainly to analytical methods, namely Kanapickiene-Grundiene model and Persons model. By applying them to Slovak companies, we tried to create a basic picture of the probability of fraud in the financial statements. Despite the limitations that the models were created under different geo - economic conditions, their use generally shows that the probability of fraud in the financial statements of Slovak companies is more than 50%. Differences in probability occur mainly in individual regions and business sectors. The general evolution of the two studied models is different. For the Kanapickiene-Grundiene model, the likelihood of fraud in accounting is increasing steadily between 2014 and 2018. Evolution of the probability is different for the Persons model.

We consider the area of fraud in the financial statements in the conditions of the Slovak Republic to be considerably unexplored, despite the huge impact of accounting fraud on individual users of accounting, such as tax authorities, financial institutions, analysts or owners themselves. The results of application analytical models clearly underline the need to pay increased attention to fraud in the financial statements of small and medium-sized enterprises. It is therefore necessary to focus more attention on this problematic area, ideally by creating a model based on information about Slovak companies that would take into account the geographical and economic specifics of Slovakia. We intend to pursue this field in further scientific work.

## References

- Albrecht, W. S., Albrecht, C., & Albrecht, C. C. (2008). Current Trends in Fraud and its Detection. *Information Security Journal: A Global Perspective*, 17(1), 2-12. doi: 10.1080/19393550801934331
- Alleyne, P., Persaud, N., Alleyne, P., Greenidge, D., & Sealy, P. (2010). Perceived effectiveness of fraud detection audit procedures in a stock and warehousing cycle. *Managerial Auditing Journal*, 25(6), 553-568. doi: 10.1108/02686901011054863
- Beasley, M. S., Carcello, J. V., Hermanson, D. R., & Neal, T. L. (2010). *Fraudulent financial reporting 1998-2007: An Analysis of U.S. Public Companies*. New York: NCFRR.
- Bell, T. B., & Carcello, J. V. (2000). A decision aid for assessing the likelihood of fraudulent financial reporting. *Auditing: A Journal of Practice & Theory*, 19(1), 169-184. Retrieved from <https://search.proquest.com/docview/216732319?accountid=15518>
- Brennan, N. M., & Mcgrath, M. (2007). Financial Statement Fraud: Some Lessons from US and European Case Studies. *Australian Accounting Review*, 17(42), 49-61. doi: 10.1111/j.1835-2561.2007.tb00443.x
- Coenen, T. L. (2008). *Essentials of Corporate Fraud*. New Jersey: Wiley.
- Chen, C., & Sennetti, J. T. (2005). Fraudulent financial reporting characteristics of the computer industry under a strategic-systems lens. *Journal of Forensic Accounting*, 6(1), 23-54.
- Dechow, P. M., Sloan, R. G., & Sweeney, A. P. (1996). Causes and Consequences of Earnings Manipulation. *Contemporary Accounting Research*, 13(1), 1-36. doi: 10.1111/j.1911-3846.1996.tb00489.x
- Dechow, P. M., Ge, W., Larson, C. R., & Sloan, R. G. (2011). Predicting Material Accounting Misstatements. *Contemporary Accounting Research*, 28(1), 17-82. doi: 10.1111/j.1911-3846.2010.01041.x
- Elliot, R., & Willingham, J. J. (1980). *Management fraud: Detection and deterrence*. Princeton: Petrocelli Books.
- Hancox, D. R. (2007). Strong Controls, but the Wrong Controls. *Edpacs*, 36(5-6), 1-5. doi: 10.1080/07366980701804995
- Harris, D. G. (1993). The Impact of U.S. Tax Law Revision on Multinational Corporations Capital Location and Income-Shifting Decisions. *Journal of Accounting Research*, 31, 111-140. doi: 10.2307/2491167
- Goel, S., & Gangolly, J. (2012). Beyond The Numbers: Mining The Annual Reports For Hidden Cues Indicative Of Financial Statement Fraud. *Intelligent Systems in Accounting, Finance and Management*, 19(2), 75-89. doi: 10.1002/isaf.1326
- Guenther, D. (1994). Earnings Management in Response to Corporate Tax Rate Changes. *The Accounting Review*, 69(1), 230-243. Retrieved from <http://www.jstor.org/stable/248269>
- Jones, M. J. (2011). *Creative Accounting, Fraud and International Accounting Scandals*. New Jersey: Wiley.
- Kanapickiene, R., & Grundiene, Ž. (2015). The Model of Fraud Detection in Financial Statements by Means of Financial Ratios. *Procedia - Social and Behavioral Sciences*, 213, 321-327. doi: 10.1016/j.sbspro.2015.11.545

- Kwok, W. C., & Sharp, D. (2005). Power and international accounting standard setting. *Accounting, Auditing & Accountability Journal*, 18(1), 74-99. doi: 10.1108/09513570510584665
- Moyes, G., & Hasan, I. (1996). An empirical analysis of fraud detection likelihood. *Managerial Auditing Journal*, 11(3), 41-46. doi: 10.1108/02686909610115231
- Persons, O. S. (2011). Using Financial Statement Data To Identify Factors Associated With Fraudulent Financial Reporting. *Journal of Applied Business Research*, 11(3), 38-46. doi: 10.19030/jabr.v11i3.5858
- Rezaee, Z. (2010). Causes, consequences, and deterrence of financial statement fraud. *Critical Perspectives on Accounting*, 16(3), 277-298. doi: 10.1016/s1045-2354(03)00072-8
- Rosner, R. (2003). Earnings Manipulation in Failing Firms. *Contemporary Accounting Research*, 20(2), 361-408. doi: 10.1506/8evn-9krb-3ae4-ee81
- Seow, J. L. (2009). Cue usage in financial statement fraud risk assessments: Effects of technical knowledge and decision aid use. *Accounting and Finance*, 49, 183-205. doi: 10.1111/j.1467-629X.2008.00268.x
- Shackelford, D., & Shevlin, B. (2001). Empirical tax research in accounting. *Journal of Accounting and Economics*, 31(1-3), 321-387. doi: 10.1016/s0165-4101(01)00022-2
- Singleton, T. W., Bologna, G. J., Lindquist, R. J., & Singleton, A. J. (2006). *Fraud auditing and forensic accounting*. New Jersey: Wiley.
- Spathis, C., Doumpos, M., & Zopounidis, C. (2002). Detecting falsified financial statements: a comparative study using multicriteria analysis and multivariate statistical techniques. *European Accounting Review*, 11(3), 509-535. doi: 10.1080/0963818022000000966
- Wang, T. Y., Winton, A., & Yu, X. (2010). Corporate Fraud and Business Conditions. *The Journal of Finance*, 65(6), 2255-2292. doi: 10.1111/j.1540-6261.2010.01615.x
- Weisenborn, D., & Norris, D. M. (1997). Red flags of management fraud. *National Public Accountant*, 42(2), 29-33. Retrieved from <https://search.proquest.com/docview/232355687?accountid=15518>
- Wells, J. T. (2004). New Approaches to Fraud Deterrence: It's Time to Take a New Look at the Auditing Process. *Journal of Accountancy*, 197(2), 72-76. Retrieved from <https://search.proquest.com/docview/206781990?accountid=15518>
- Zhou, W., & Kapoor, G. (2011). Detecting evolutionary financial statement fraud. *Decision Support Systems*, 50(3), 570-575. doi: 10.1016/j.dss.2010.08.007

## Contact information

**Ing. Jaroslava Šepel'ová**

University of Economics in Bratislava, Faculty of National Economy

Dolnozemska cesta 1, 85235, Bratislava, Slovak Republic

E-mail: [jaroslava.sepelova@euba.sk](mailto:jaroslava.sepelova@euba.sk)

ORCID: 0000-0002-6093-6949

doi: 10.7441/dokbat.2019.098

# AGRICULTURE AND ITS POSITION WITHIN THE COUNTRY'S ECONOMY

*Elena Širá*

## **Abstract**

Agriculture has a significant economic position in each country, either historically or in terms of importance. Without the products of agriculture, there could be no life. That is why we decided to analyse this industry. The main objective of the paper is to identify the position of agriculture within the economy in the Slovak Republic. We analyse the period of more than 20 years to get the representative data. Through selected indicators, we want to describe the position of this industry in the past and today. We analyse the indicators typically for agriculture. They are crop production and livestock production. Also, the GDP of agriculture is very important to set the position of this selected sector in the economy of the state. To measure and compare the GDP, we analyse the growth of GDP for better and comparable results. Through a regression model, we would like to know what is the dependence of crop and livestock productions on the GDP of agriculture. If there are some dependence or not. Finally, we will try to suggest improvements to the current state, for agriculture as a whole and, especially for crop and livestock production, too. The presented article approximates a case study of Slovak agriculture and their performance in time. The obtained results show that the statistical significance is assumed, which of course is confirmed both in crop and livestock production. The share of agriculture in the economy of the Slovak Republic is dependent on the production of agriculture. There is a need to improve and thereby promote production both in crop and livestock productions.

**Keywords:** *agriculture, crop production, livestock production, Slovak Republic, gross domestic product, economy*

## **1 INTRODUCTION**

In today's dynamically developing economies, many countries face a huge challenge such as high competition, also in the sector of agriculture. There are also unpredictable changes in customer trends and requirements. (Porter & Donthu, 2008) Specific for this sector are also unpredictable changes in weather, which affect the future results in this area. Agriculture provides much more than just food for people. Therefore, in this way, it is a very important part of any economy and therefore it is necessary to pay attention to it.

For these reasons, we have chosen this area of economy for analysis. The main aim of this paper is to identify the position of agriculture within the economy in the Slovak Republic. This sector has a long tradition, but in the last years, there are many effects, that change its performance.

Through selected indicators, we want to describe the position of this industry in the past and today. We analyse the indicators typically for agriculture. They are crop production and livestock production. To show the impact of this industry on the country's economy, we chose an indicator GDP for analysis. In the next step, a regression model will be done. Through this model we would like to know what is the dependence of crop and livestock productions on the GDP of agriculture. If there are some dependence or not.

## **2 THEORETICAL FRAMEWORK**

The national economy production is organized in the sectors structure (Freňáková, Gazda & Jasovská, 2010). The national economy is usually divided into three sectors. Agriculture belongs to the primary sector according to this division (Širá, 2013). The benefits of agriculture have been immense. Agriculture was one of the leading sectors of the economy of the country for the years (Hvizdova, Mokrisova & Polacko, 2016). Agriculture as an area of productive activity has a number of general attributes that distinguish it from other sectors of the economy, including high asset specificity, which impedes resource mobility out of agriculture (Valentinov, 2007). This sector has passed through complicated restructuralization in their development (Širá, 2015).

Agricultural practices determine the level of food production and, to a great extent, the state of the global environment (Tilman et al., 2002). Agriculture is diverse and full of contradictions (Adamišin, Kotulič & Vozarova, 2017; Andrić & Horvat, 2015). The sector accounts for a comparatively small share of the global economy, but remains central to the lives of a many people (Dobrovič, Koraus & Dancisinova, 2017; Alston, Pardey, 2014). Agriculture supplies much more than food for direct human consumption: it produces significant amounts of feed (for livestock), fuel (for transportation, energy production, including household kitchen fires), fibre (for clothing), and, increasingly, agricultural biomass used to produce a host of industrial chemical and material products (Alston & Pardey, 2014).

We can find two key characteristics of agriculture. First, agriculture produces goods that directly satisfy basic human needs (Diao et al., 2007). A high dependence on nature means that agricultural producers have relatively low control over the processes and results of production (Valentinov, 2007). The production of 1 kg of meat can require between 3 and 10 kg of grain. During the past 40 years, global per capita meat production has increased more than 60% (Tilman et al., 2002). On the other hand, the crop production depends strongly on the weather conditions.

Second, agricultural production combines human effort with natural resources, such as land and agro-ecological assets (Kotulič et al., 2017). Early development theorists believed that, since natural resources were assumed to be freely available, agriculture could grow independently of other economic activities. However, in reality, the dependence of agriculture on a fixed supply of land meant that its expansion was constrained, implying that agricultural output cannot proportionally increase with increased labour supply under a given technology (that is, agriculture suffers from diminishing returns). Classical theorists observed that most developing countries comprise “dual” economies (Bađo, 2016). In this view, labour productivity is lower in agriculture than in industry, and hence development requires the movement of agricultural labour into non-agricultural sectors (Diao et al., 2007).

## **3 METHODOLOGY**

Agriculture has a dominant, historical and very significant impact on the economy of each country. For this reason, we have analysed this sector of the economy. The aim of the paper is to identify the position of agriculture within the SR economy. The impact of industry on the economy of the country is examined and verified by various indicators. We have selected the following indicators for the analysis:

- a) GDP of agriculture - in absolute terms as well as % of the total GDP of the country;
- b) crop production (CP);
- c) livestock production (LP).

We set the hypothesis:

*H0: There is no statistically significant relationship between GDP from agriculture, crop and livestock productions*

*H1: There is a statistically significant relationship between GDP from agriculture, crop and livestock productions*

For the analyses, we have chosen the period of 1995-2017. We examined whether crop and livestock productions are affecting the GDP of agriculture. We used a multiple regression model to assess dependence, and the calculations were done in the GRETl statistical programme.

## 4 RESULTS

Basic macroeconomic indicators include gross domestic product. The growth rate of the gross domestic product is the main indicator used in evaluating performance of every economy (Simionescu et al., 2017). The share of agriculture in GDP was different in individual years, or it could be said that it had a growing but predominantly rather fluctuating trend. After the EU accession, the agriculture in Slovakia recorded a positive economic result on a yearly basis, as we can see in Chrastinova and Burianova (2012), Kotulič et al. (2018).

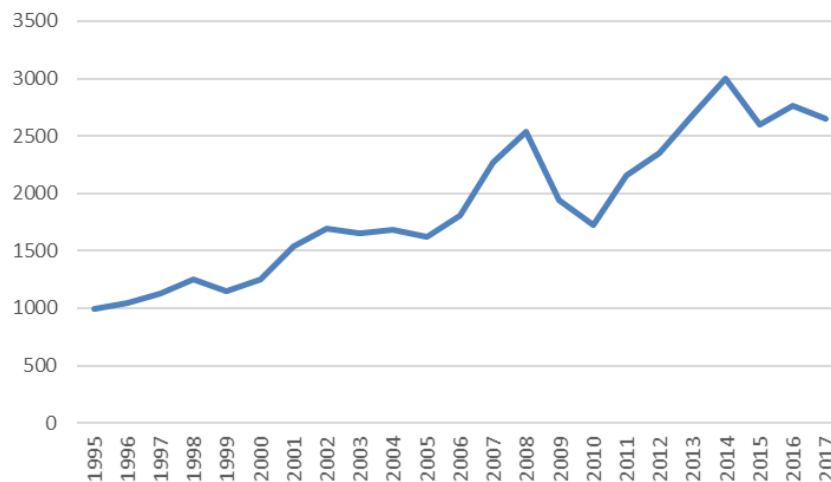

Fig. 1 – Growth of GDP in agriculture, forestry and fisheries. Source: own research

From Figure 1, we can see that the share of agriculture on GDP has grown since 1995. In 1998, the share of agriculture in GDP fell slightly, but increased in 2000 and thus also affected economic growth and the importance of the agricultural sector. Since 2008, the decline in agricultural production started and agriculture experienced a decline in GDP of the Slovak Republic and this trend prevailed until 2010. GDP of the Slovak Republic, despite the decline in the agricultural sector, was steadily increasing. The course of 2011 to 2014 had a slightly growing trend. In 2015, there was a slight decline in agriculture, which was marked by significant falls in commodity prices. The year 2016 had a positive impact on the share of agriculture in GDP production, mainly from crop production, and therefore had a growing trend. However, the price of agricultural commodities still had a significant impact on GDP generation, like in previous years. For a better understanding, or better reporting value, we have shown share of agriculture, forestry and fisheries in percentage terms on GDP, which can be seen in Figure 2.

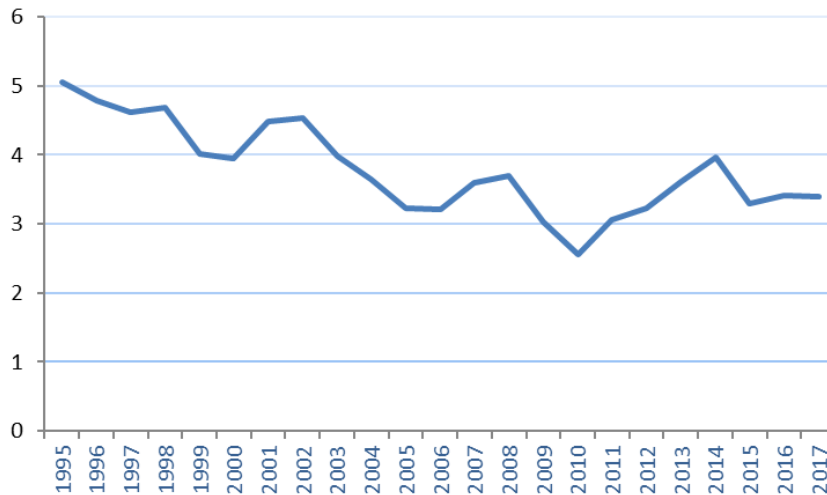

Fig. 2 – GDP growth in agriculture, forestry and fisheries in percentage terms. Source: own research

Crop and livestock productions should also have a significant impact on agricultural GDP. We have therefore examined whether crop and livestock productions are affecting the agricultural GDP. Multiple regression model is used to assess dependence.

To write a multiple regression model:

$$\text{GDP poli} = \alpha + \beta_1\text{CP}_i + \beta_2\text{LP}_i + u_i \quad i = 1, 2, \dots, n \quad (1)$$

Our dependent variable is  $y_i = \text{GDP poli}$  and the independent variable representing the coefficients  $\beta_1$  is  $\beta_1 = \text{CP}$  and  $\beta_2$  is  $\beta_2 = \text{LP}$ . Furthermore, it is the coefficient  $u_i$ , representing the error.

Writing the estimated multiple regression model:

$$\text{GDP poli} = 1190.14 + 2.03\text{CP}_i - \beta_2 1.32\text{LP}_i + u_i \quad i = 1, 2, \dots, n \quad (2)$$

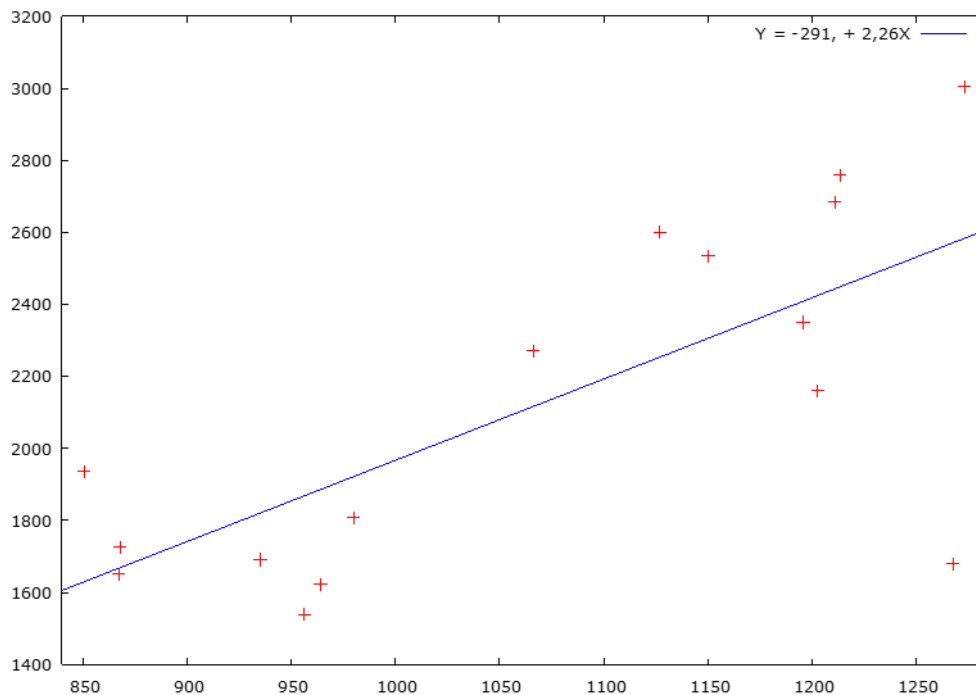

Fig. 3 – Agriculture GDP dependence on CP. Source: own research



On Figure 3, there is seen the relationship between GDP of agriculture and crop production. The sequence of the function in the figure is described in the form of an equation that has the following form  $y = -291 + 2.26x$ .

Verifying hypotheses is as follows:

*H0: There is no statistically significant relationship between GDP from agriculture, crop and livestock productions ( $H0 = 0$ );*

*H1: There is a statistically significant relationship between GDP from agriculture, crop and livestock productions ( $H1 \neq 0$ ).*

Verification of hypotheses is performed through P values. P value of CP is p-value = 0.029. The P-value of the livestock production is 0.05. These results show that we have statistical evidence that CP and LP are important. This value is less than 0.05, so H0 rejects and accepts the hypothesis H1. Figure 4 shows the dependence between the GDP of agriculture and the livestock production.

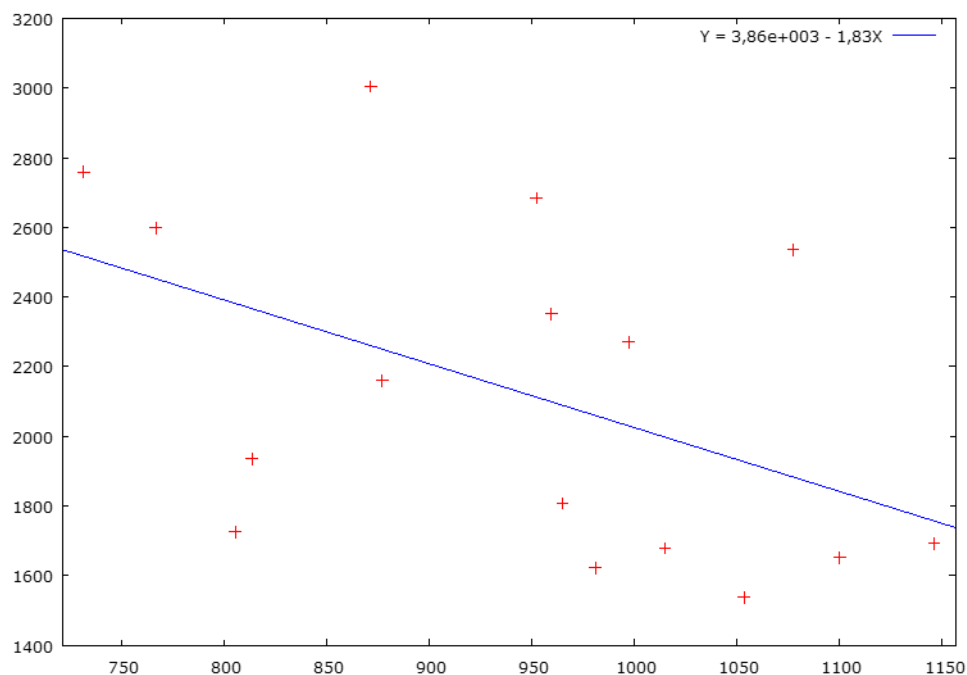

Fig. 4 – Agriculture GDP dependence on the livestock production. Source: own research

The graph shows the course of the function, which is described in the form of an equation that has the following form:  $y = 3.86e + 0.003 - 1.83x$ . This means that the variable livestock production has a negative sign, which explains indirect dependence. Every year, livestock production is declining. An important factor is the coefficient of determination = R<sup>2</sup>, which tells us about the variability of the GDP of agriculture. This figure has the term "R-squared" and its value is 0.6180, representing 61.80% of the variability share in the agricultural GDP.

## 5 CONCLUSION

Agricultural GDP dependency is also verified from the point of view of crop and livestock productions. The statistical significance is assumed, which of course is confirmed both in crop and livestock production. While direct depending was confirmed in crop production, indirect dependency was confirmed in livestock production. This indirect dependence is explained by

the fact that, despite declining livestock production, this production is still the essence and statistically significant part of the GDP of agriculture.

The share of agriculture in the economy of the Slovak Republic is dependent on the production of agriculture, with which the necessity of constant improvement and provision of livestock as well as crop production is related. There is a need to improve and thereby promote production both in crop and livestock productions. However, livestock production has been declining in the monitored periods and stabilization is needed. Stabilization can be done, for example, by means of incentives to ensure better conditions for livestock production, as well as by increasing livestock numbers, which are very low in recent years.

In contrast with the United States, the EU has a trade surplus in the food and drinks processing sector. (Wilkinson, 2012) So the question is, how to get the amount of agriculture production higher? We show, that the agriculture in the Slovak republic has the potential to grow. So this area can be investigated in further research papers.

Small and medium-sized entrepreneurship in advanced countries constitute significant accelerator of employment, innovation and economic growth. In past years in Slovakia we can see, that the SMEs have increasing share on national economy. (Mura & Buleca, 2012) So in the area of agriculture, this SMEs can be provided by family farms. Family farms present a new approach to agriculture. So, this issue can be examined for future study.

## References

- Adamisin, P., Kotulic, R., & Vojarova, I. K. (2017). Legal form of agricultural entities as a factor in ensuring the sustainability of the economic performance of agriculture. *Agricultural Economics*, 63(2), 80-92. doi: 10.17221/208/2015-AGRICECON
- Alston, J. M., & Pardey, P. G. (2014). Agriculture in the global economy. *Journal of Economic Perspectives*, 28(1), 121-46. doi: 10.1257/jep.28.1.121
- Andrić, B., & Horvat, D. (2015). Social media communication in agriculture: Case study of Croatian wine market. *11th Annual International Bata Conference for Ph. D. Students and Young Researchers*. Retrieved from <http://dokbat.utb.cz/2016/wp-content/uploads/2015/04/DOKBAT-2015-Conference-Proceedings.pdf>
- Bad'o, P. (2016) Government debt management, Structure and economic growth: Investigation of the Visegrad Four. *12th Conference Proceedings DOKBAT*, 23-30. Retrieved from doi: 10.7441/dokbat.2016.03
- Diao, X., Hazell, P. B., Resnick, D., & Thurlow, J. (2007). The role of agriculture in development, International Food Policy Research Institute. Retrieved from <https://ebrary.ifpri.org/cdm/ref/collection/p15738coll2/id/125252>
- Dobrovic, J., Koraus, A., & Dancisinova, L. (2016). Sustainable economic development of slovakia: factors determining optimal tax collection. *Journal of Security & Sustainability Issues*, 5(4), 533-544. doi: 10.9770/jssi.2016.5.4(8)
- Freňáková, M., Gazda, V., & Jasovská, J. (2010). Hidden cooperation or competition among industrial production branches: some results for the Slovak republic. *E + M Ekonomie a Management*, 3, 6-15. Retrieved from <https://dspace5.zcu.cz/handle/11025/17350>
- Hvizdova, E., Mokrisova, V., & Polacko, J. (2016). Changes in research and development after crisis in selected countries. *Економічний часопис-XXI*, (160), 31-35. Retrieved from <http://soskin.info/userfiles/file/Economic-Annals-pdf/DOI/ea-V160-06.pdf>

- Chrastinova, Z., & Burianova, V. (2012). Economic efficiency of Slovak agriculture and its commodity sectors. *Agricultural Economics*, 58(2), 92-99. doi: 10.17221/162/2010-agricecon
- Kotulic, R., Adamisin, P., Vozarova, I., & Vavrek, R. (2018). The Impact of Management Skills of Agricultural Entities in Relation to the Economic Result and their Legal Form. *VII. International scientific conference Management 2018*, 222-227. doi: 10.14505/jemt.v8.1(17).09
- Kotulic, R., Adamisin, P., Vozarova, I., & Vavrek, R. (2017). The Impact of Management Skills of Agricultural Entities in Relation to Economic Efficiency and Natural-Climatic Conditions in Slovakia. *Journal of Environmental Management & Tourism*, 8(1), 92-99. doi: 10.14505/jemt.v8.1(17).09
- Mura, L., & Buleca, J. (2012). Evaluation of financing possibilities of small and medium industrial enterprises. *Procedia Economics and Finance*, 3, 217-222. doi: 10.1016/S2212-5671(12)00143-8
- Porter, C. E., & Donthu, N. (2008). Cultivating Trust and Harvesting Value in Virtual Communities. *Management Science*, 54(1), 113-128. doi: 10.1287/mnsc.1070.0765
- Simionescu, M., Lazányi, K., Sopková, G., Dobeš, K., & Balcerzak, A. P. (2017). Determinants of economic growth in V4 countries and Romania. *Journal of Competitiveness*, 9(1), 103-116. doi: 10.7441/joc.2017.01.07
- Širá, E. (2015). Slovak Food Processing Industry in the Context of Globalisation and Integration Tendencies. *Polish Journal of Management Studies*, 11(1), 158-167. Retrieved from <https://pjms.zim.pcz.pl/resources/html/article/details?id=167189>
- Širá, E. (2013). Analysis of Slovak Agricultural Position from the Perspective of Selected Indicators and Slovak Regions. *Polish Journal of Management Studies*, 8, 229-241. Retrieved from <https://pjms.zim.pcz.pl/resources/html/article/details?id=187512>
- Tilman, D., Cassman, K. G., Matson, P. A., Naylor, R., & Polasky, S. (2002). Agricultural sustainability and intensive production practices. *Nature*, 418, 671-677. doi: 10.1038/nature01014
- Valentinov, V. (2007). Why are cooperatives important in agriculture? An organizational economics perspective. *Journal of Institutional Economics*, 3(1), 55-69. doi: 10.1017/S1744137406000555
- Wilkinson, J. (2012). The Food Processing Industry, Globalization and Developing Countries. In E. B. McCullough, P. Pingali & K. Stamoulis (Eds.), *The Transformation of Agri-Food Systems*. London: Routledge. doi: 10.4324/9781849773331-12

## Contact information

### Ing. Elena Širá, Ph.D.

University of Prešov in Prešov, Faculty of Management  
 Konštantínova 16, 08001, Prešov, Slovak Republic  
 E-mail: elena.sira@unipo.sk  
 ORCID: 0000-0002-9907-1372

doi: 10.7441/dokbat.2019.099

# ENVIRONMENTAL & INDUSTRIAL EFFECTS OF PALM OIL

*Izidor Škrbot, Mark Kmetec, Timitej Zorman, Domen Keblič, Matevž Obrecht*

## Abstract

Palm oil trees from which companies produce palm oil are replacing more and more tropical forests around the equator. Indonesia and Malaysia are two largest exporting countries and they are two most prolific countries when it comes to replacing biodiverse forests for palm oil plantations. Tropical countries other than two before mentioned are also promoting palm oil industry as a mean to poverty alleviation. Palm oil consumers and non-governmental environmental organizations are starting to pressure retailers and producers to focus on sustainable production of palm oil, for forest preservation and sustainable development. Considering pressing concerns for cleaner and sustainable palm oil production a certificate called Roundtable on Sustainable Palm Oil (RSPO) was created. Products produced and refined out of oil palm fruits are ever more demanded, to the point that tropical countries spend millions to chop down thousands of square kilometres of forests to meet the worlds demand. Many new oil palm plantations in Indonesia and Malaysia are created over chopped down peatlands. Peatlands have stored vast amounts of CO<sub>2</sub> over time that is being slowly released, when we change peatlands into various plantations, mainly into oil palm plantations. Also waste management practices of exporting countries are still lacking, the side products of palm oil refining are still not utilized enough. The oil palm expansion should be slowed down, and countries need to focus more of their efforts to optimize the usage of by-products that are created in the process of making palm oil, then chopping down more rainforest's.

*Keywords: biodiesel, industry, sustainable palm oil, waste management, cleaner energy, RSPO*

## 1 INTRODUCTION

The palm oil industry is increasing at an astonishing rate over the last 10 years. One of the main reasons for the increase is its usage in fraying, processed foods, cosmetics, detergents and recently booming biodiesel production. Expansion of land used for palm oil production is said to grow in the near future. Increase of production, will happen at a slower pace as before, but its impact will be greater than in the past. Palm oil land use, growth and economic potential is hard to evaluate, its high yields make it an affordable choice over competition (Pirker et al., 2016). The amazing increase of palm oil production over the years also partly explains the why LUC (Land use change) has become a big worry for the sustainability of the industry. The global land area of oil palm plantations increased from 3.5 million hectares in 1975 to 13.1 million hectares in 2005 and is still drastically increasing today (Wicke et al., 2011).

Therefore, the question is what palm oil actually is. Palm oil is a lipid that you can acquire by extracting the fruits of the oil palm tree. The palm tree belongs to the Palmae family and can grow up to 20 meters. The fruits of the palm tree have around 45% to 50% oil content and the lifespan of the tree goes from 25 to 30 years. The palm fruits also give the highest percentage of oil per unit of any crop. It is a perfect cheap alternative with the right characteristics for the incorporation into food products (Edem, 2002). Palm oil has also a unique fatty acid (FA) and triacylglycerol (TAG) profile that makes it suitable for numerous food applications (Mba, Dumont & Ngadi, 2015).

If we look more into the increasing production of palm oil, we see that from year 1995 to 2010 the production tripled and its mainly produced in two major countries, Indonesia with a 47%

global market share and Malaysia with a 38% market share. The oil is used as main cooking oil for the majority of people in Middle East because of its low cost compared to other cooking oils. Malaysia saw the opportunity in palm oil production, and in a span of 40 years, Malaysia reached one of the highest GDP per capita in Asia (Mahat, 2012). In year 2006, Malaysia was the biggest producer and exporter of palm oil in the world accounting for 52% of the total world's oils and fats exports (Sumathi, Chai & Mohamed, 2008).

Palm oil production brings great prosperity in long span of time, because of a great demand of the products created from oil palms. However, at the same time the way oil palm plantations are set up it causes great stress on cultivated land. There are tens of thousands of km<sup>2</sup> of forests being chopped down and burned in preparation to plant oil palms each year, with numbers growing each year also (Carlson et al., 2012). It was also revealed that the primary forests and logged forests to oil palm plantations decreases the volume of species, to be more specific it decreases 77% of forest birds (Koh & Wilcove, 2008). Ninety percent of palm oil throughout the world is now used for edible purposes (margarine, ice cream, chocolate) (Edem, 2002). Since palm oil usage has drastically increased in the last few years, more and more people are aware of palm oil, but a lot less is known about its background production and logistics.

In this paper we would like to find out more about palm oil production, its environmental effects, the lengths companies go to make their production of oil sustainable or not at all. We would like to research the global trend of replacing tropical forests with plantations, and find if there are alternatives. There are many palm oil side products, which are mostly used up but not all of them, we would like to point out the value of those products. In addition, at the end we would like to add our opinion on the palm oil production and management as a whole.

## **2 METHODOLOGY**

Our whole article is made by reviewing multiple articles made by different authors. We searched them through various internet sites like Google Scholar, Springer Link, Web of Science and Science direct. Palm oil is not a newly known problem, which is why we did not set any restrictions on how old the specific articles should be. We searched on the site with the terms palm oil, palm oil biodiesel, palm oil substitutes, palm oil logistics, palm oil in cosmetics, palm oil in food, palm trees, Malaysia palm economy, oil palm, palm fruits, palm oil standardization, palm oil sustainability, palm oil Indonesia, palm oil Malaysia, palm oil bio fertilizer, palm oil sustainable substitute, peatland palm oil, peatland Malaysia, peatland, peatland type, palm oil plantation, Round table on Sustainable Palm oil, RSPO, high conservation value, HCV, high carbon stock, HCS, high conservation value and high carbon stock palm oil, RSPO palm oil. We restricted our search by turning off the options for patents and references. That way Google did not include them in our search. We decided against them, because they would not help us with the article, because they are either too specific or too complex. Because the problem with palm oil is globally known and we speak multiple languages, we allowed that the articles searched could be in English and German language. We managed to find more English articles on our subject. Because we accepted German literature in our search, we also searched by the terms “palm öl”, “palm oil biodiesel”, “palmöl ersatz”, “palmöl logistic”.

All the articles had to be sorted out, so we sorted out the articles that we did not need, so that only the best articles remained. We did that by conducting specific searches. After we analysed all the articles, we divided the problem, so that it would be easier to study it. We divided it on the real problem, the substitutes, and the usage and future options. We compared the selected remaining articles, so that we avoided some misinformation. After going through every article,

we collected all the information we got from the articles and wrote it in this article along with some of our thoughts.

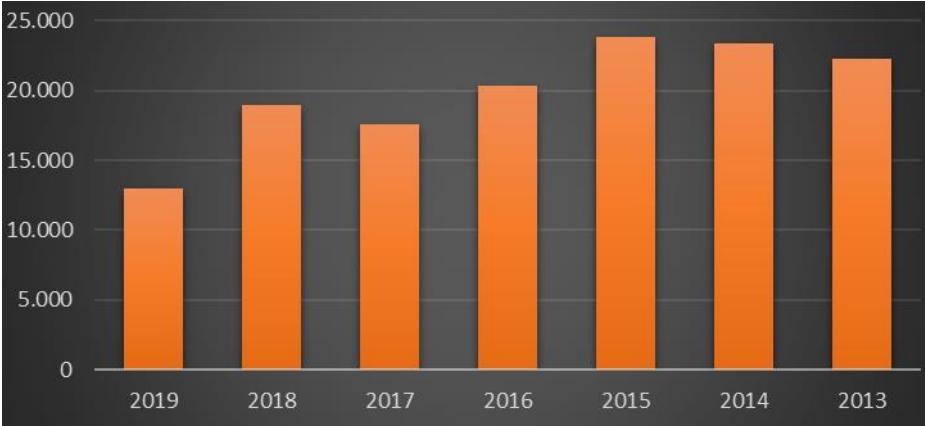

Fig. 1 – Hits on the term “Palm oil” per year. Source: own research

As we searched for the right articles on the site Google Scholar, we wanted to see how the popularity of the term Palm oil changed through the years. We made a chart where we see that there has been a slight decline of articles from the year 2015 to the year 2018. The term reached its pick of article numbers in the year 2015. In that year, there were 23,800 articles. We still do not need to be worried, as in month May, in the time of the writing of this article, already a number of 13,000 articles can be found online. That means in half a year this number could double and exceed the numbers of 2015, but this are only predictions.

### 3 RESULTS

#### 3.1 Environmental issues regarding palm oil

Palm oil demand is increasing with each year and tropical countries see an opportunity in expanding its industry in search of poverty alleviation. However, a large portion of space currently occupied by palm oil production in Malaysia and Indonesia were a result of thinning out a biodiverse-rich tropical forest. (Pirker et al., 2016).

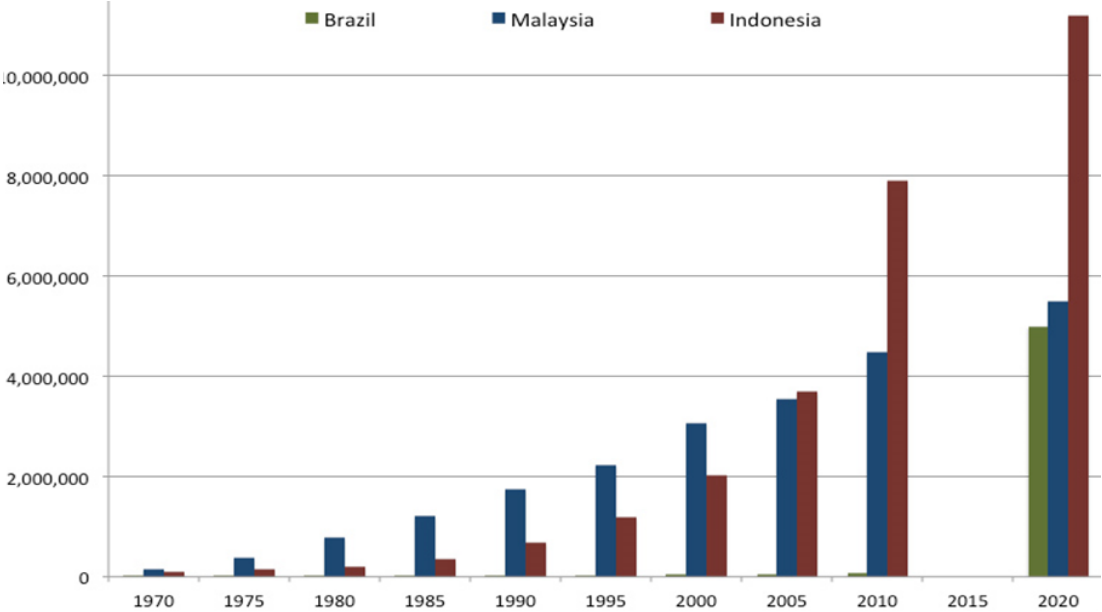

Fig. 2 – Forecast of palm oil acreage. Source: Butler (2011)

In Indonesia, expansion of palm oil and its industry has caused massive deforestation of tropical forests for the sake of planting plantations in its place. The expansion of palm oil plantation in the years 1990 to 2000 was around 746 km<sup>2</sup> comprising of around 8,300 km<sup>2</sup>. Then from 2000 to 2010, the expansion rapidly increased to 2,300 km<sup>2</sup> to 32,600 km<sup>2</sup> in 2010. By the year 2020 the projection is that Indonesia will clear a further 93,000 km<sup>2</sup> of land for palm oil production, the total being around 120,000 km<sup>2</sup>. Most of the plantations build up to the year 2010 was built on forested land. Ninety percent of all plantations were once tropical forest and only around 10% being built on non-forested lands. (Carlson et al., 2012)

A big part of emissions in Indonesia is caused by clearing forests in preparation for palm oil planting. In many situations workers use fire to help them burn chopped down forest in preparation for oil palms. Fifty-six percent of all emissions caused by palm industry in years 1990 to 2000 were caused by clearing fields with fire. Emissions from land change in year 2020 are projected to reach 34% of all Indonesian land change emission generation, 27% of that being caused by palm oil plantations (examples of that are logging and wildfires). Prevention of deforestation of intact and logged forests would cause a 50% reduction of carbon emissions attributed to palm oil plantations. Around 6% of all emissions generated by Indonesia can be attributed to palm oil production. (Carlson et al., 2012)

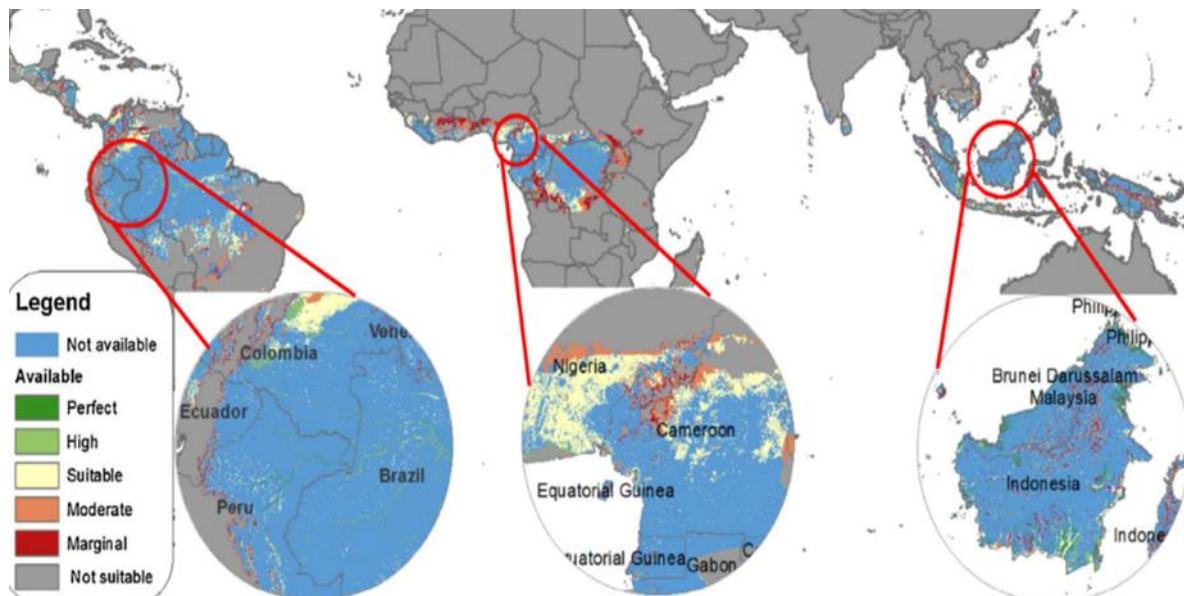

Fig. 3 – Suitable palm oil land. Source: Pirker et al. (2016)

Emissions are not the only bad thing in this aftermath. These rain forests are known to be habitats for different kind of animals. By destroying them, we destroy whole ecosystems. Many animals become endangered or even go extinct because of that. One of the species, who is endangered, because of these actions, are the orang-utans. They are mostly found in parts of Indonesia and Malaysia, who are the biggest contributors to palm oil production, Particularly Borneo, an island in Malaysia, and Sumatra, an island in Indonesia are heavily impacted by it.

These two islands are also known as the natural habitats for orang-utans. Orang-utans are charismatic, arboreal primates that live in rainforests and peat forests. They live solely or in groups up to three orang-utans, because of they are hard to track. It is forecasted that annually between 496 and 901 km<sup>2</sup> of orang-utan habitat could be lost, because of deforestation for palm oil plantations. Palm oil plantations need a lot of sun, they need to be planted in clear areas, but orang-utans need high trees and forest covers, so one excludes the other. The biggest problem is that the countries do not get a lot out of the orang-utans. Even for tourism, they are not so attractive, because of their difficult tracking. On the other hand, it is reported that in 2007

Indonesia and Malaysia made a profit from palm oil of 14 billion US dollars and 5.5 billion US dollars, respectively. (Swarna Nantha & Tisdell, 2009)

Despite palm oil being able to grow on mineral poor land, most new plantations are built on forest, that were chopped down for sole purpose of expanding production. Palm oil plantations can also be built on lands, where more demanding plants can no longer thrive, because there is a lack of fertile soil exhausted by other plants.

### **3.2 Peatland plantations and CO<sub>2</sub> consequences**

Peatlands or mires are its own ecosystems that has high content of decomposing organic materials. Peatland is created, when an amount of photosynthetically produced organic matter exceeds the loss of organic matter through decomposing. Most of peatlands are located on the northern hemisphere, with small percentage being in southern hemisphere. Peatlands are generally separated into fens, (mineral rich peatlands that get minerals from water scraping rocks) or bogs (accumulated minerals through precipitation) (Vitt, 2008). Peatlands are mostly found around fresh water and cold climates in high latitudes, in oceanic environments and moist tropical climates (Craft, 2016).

Peatlands, that are important for their carbon content, are under threat in South East Asia. A big part of new plantations in Malaysia is being planted on peatlands, yet the exact effect on the environment is mostly unexplored (Delabre et al., 2018). Drained water in preparation for oil palm trees exposes peatlands, to oxygen, and increases the rate at which carbon rich peat decomposes significantly increases CO<sub>2</sub> release into environment. It is estimated, that 1.3% to 3.1% of all global emissions is contributed by peatland drainage in Southeast Asia (Hooijer et al., 2010).

### **3.3 Palm oil waste management**

Waste management movement in recent years has created a need to improve sustainable and return logistics in all sectors. While palm oil creates enormous revenue, the by-products of palm have further potential uses, bringing palm oil closer to realizing zero waste management. Major by-products of palm oil are palm fatty acid distillate (PFAD), soap stock, and spent bleaching earth (SBE). With further processed, by other industries these by-products can be turned into animal feed, biodiesel, lubricant and soap. Soap stock acquired in the process of making palm oil from crude palm oil mostly contain free fatty acids (FFA), which have variety of end uses.

Soap stock is most useful as nourishment for microorganisms, a reactant for chemical industry and it is essential as a feedstock in animal industry. On the other hand, (SBE) retains around 20%-40% of the crude oil in the process of refining, when the residual palm oil is extracted, it can be sold as a raw material mainly for biodiesel and lubricant industries. In recent years, the potential uses of SBE have been realized, but it is still under-utilized. Big quantities of SBE is still treated as a waste and disposed of in land fields, where it can turn into environmental hazard, and increases disposal costs. Around 95% of CPO in Malaysia is refined through physical process, which is ecologically friendlier, because it uses less water in the process and the process retains more FFA than chemical refining. The refining products are refined bleached and deodorized palm oil (RBDPO) and neutralized bleached and deodorized palm oil (NBDPO) (Haslenda & Jamaludin, 2011).

The sole chemical energy content of the harvested palm fruit and the biomass is bigger than the energy input through the farming system. Therefore, palm oil can be used as a source of sustainable energy production. The palms in Malaysia are planted with a density of 148 palms per hectare and each palm has around 150 kg of fresh fruit bunches (FFB). The palm oil industry is already fond of the environmental pollution and it is trying to reduce the problem through



sustainable development and a cleaner technology. By extracting the oil from the fruits, the empty fruit bunches are usually incinerated and used for soil fertilizer. However due to the white smoke produced in the industry, the Department of Environment (DoE) discourages incineration of empty fruit bunches (Yusoff, 2006).

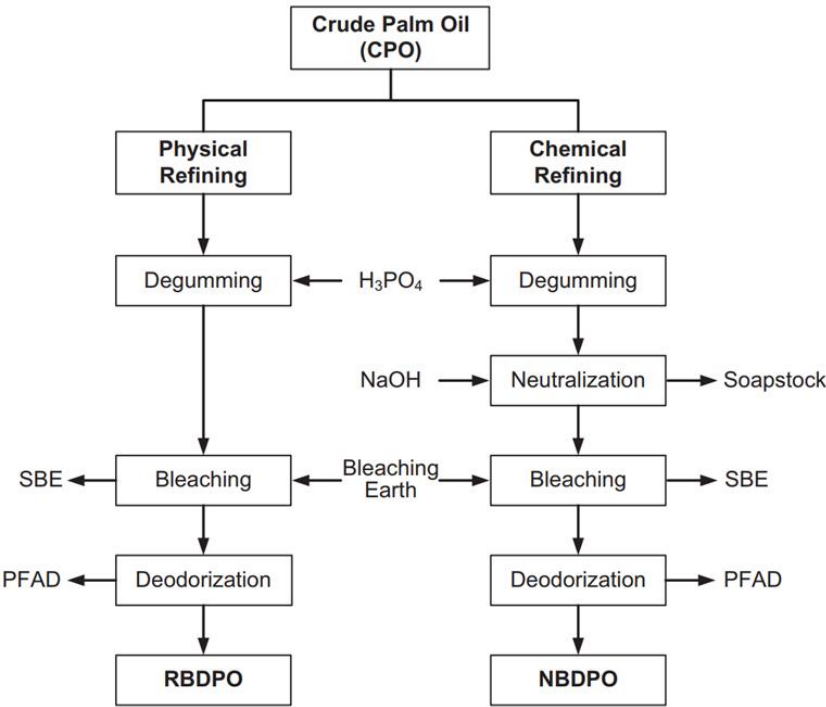

Fig. 4 – Main types of CPO refining. Source: Haslenda & Jamaludin (2011)

**3.4 Measures to improvement of the present situation**

Realizing the importance of energy stability to support economic growth the Malaysian government introduced the so-called four-fuel strategy (petroleum, natural gas, coal and hydro) later after the realization they also added the fifth fuel policy named renewable energy. In that department, biomass plays a big role and consequently the Palm oil waste management. Therefore, the Ministry of Energy, Communications and Multimedia Malaysia launched a renewable energy program, which the main target is the usage of palm oil waste as the main waste for a renewable energy power plant. The main goal of the launch is to reduce the environmental negative impacts of the palm oil industry waste while gaining a new energy source for further usage (Yusoff, 2006).

**3.5 Political measures**

Because of the negative social and environmental impacts following the palm oil production, global voluntary agreement- the Roundtable on Sustainable Palm Oil (RSPO) was formed, the reason for it was the failure of laws at the time when RSPO was formed (Ruyschaert & Salles, 2014). There were also campaigns, which were against the negative effects of palm oil production.

These campaigns were warning about the deforestation and emissions of greenhouse gases. In 2004, the RSPO was founded. Although the association was initiated by the environmental organization WWF, the RSPO still likes to be an industry label. It is dominated by palm oil producers, large corporations and traders. Retailers, banks and investors as well as some non-governmental organizations are also members (Moreno-Peñaranda et al., 2015).

Membership in RSPO is voluntary and RSPO aims towards reaching goals of producing and processing palm oil on the sustainable basis of various socially acceptable and ecological criteria (Johnson, 2019). Palm oil producers who become members undertake to convert the entire palm oil production according to the criteria of the RSPO within a fixed time period. Certain minimum requirements (including no clearing of primary forest, solving of land conflicts and no violations of the law) apply to all plantations of the company from the beginning (Knoke & Inkermann, 2015).

The ecological and social criteria for the further certification of the palm oil are set by the RSPO itself. Altogether, there are currently 43 criteria with 138 more detailed indicators and they present the RSPO Principles and criteria (Pesqueira & Glasbergen, 2013). In addition to environmental and transparency requirements, the criteria include social criteria such as compliance with the International Labour Organization's (ILO) core labour standards, such as: Freedom of association and collective bargaining, prohibition of child labour and forced labour. If a plantation is certified, the certificate is valid for five years, but compliance with the criteria is reviewed annually (Knoke & Inkermann, 2015).

In 2015, the RSPO certified 20% of the world produced palm oil. Of these, 51% come from Indonesia, 42% from Malaysia, 5% from Papua New Guinea, and 1% each from Brazil and Colombia. There are different models for the producers to have their goods certified. These range from a complete separation of the palm oil of a particular plantation to trading of certificates, which theoretically is a completely conventional manufactured product (Knoke & Inkermann, 2015).

### **3.6 Measuring and monitoring**

RSPO is responsible for implementing High Conservation Value (HCV) and High Carbon Stock (HCS) approaches (Astari & Lovett, 2019). High conservation value (HCV) and high carbon stock (HCS) were introduced to identify and protect important environmental and social values that need to be preserved and were alarmingly overlooked in the past (Gatti et al., 2018). The palm oil industry often works in very biodiverse, carbon rich areas that are essential for the survival of local and indigenous peoples. Therefore, HCV and HCS assessments are important for companies approach to conservation, risk reduction and implementation of commitments such as to reduce deforestation, reductions of greenhouse gas emission and protection of local communities (Padfield et al., 2016).

The HCV and HCS use field and desk-based assessments to discover HCV areas and HSC forests. They choose from forests and areas that are included in palm oil production and are potentially suitable for management and monitoring for ensuring the protection for their wellbeing in the future (Hidayat, Offermans & Glasbergen, 2017). There are different opinions on the costs of resisting or mitigating development the newly discovered HCV areas and HSC forests. On the other hand, the loss caused by deforestation in terms of biodiversity, damaged habitats and land acquisition processes that invade local people is enormous. In addition, the plantations that do not use HCV or HCS are those who might get in trouble in the future in terms of costs, reputational damage and payment for settlement of damages that were done due to their ignorance to the environment. (Delabre et al., 2018)

High Conservation Value approach is a process that discovers, identifies, manages and monitors biologically, ecologically, socially or culturally valuable sources that are significantly or critically important at the national, regional or global level (Yapp et al., 2010). The High Conservation Value approach is divided into six categories (Delabre et al., 2018):

HCV 1: Concentrations of biological diversity, including rare, threatened or endangered species.

HCV 2: Landscape-level ecosystems and mosaics, including intact forest landscapes.

HCV 3: Rare, threatened, or endangered ecosystems, habitats or refugia.

HCV 4: Basic ecosystem services in critical situations, including water catchments.

HCV 5: Sites and resources fundamental for satisfying the necessities of local communities or indigenous peoples.

HCV 6: Sites, resources, habitats and landscapes of global or national cultural, archaeological or historical significance.

361,468 ha of palm oil plantations have been in the process of receiving HCV assessment compliant with the rules of RSPO's New Planting Procedure. Of the 361,468 ha just 88,055 ha have been awarded with HCV areas (Delabre et al., 2018).

High Carbon Stock (HCS) is a land-use planning approach that divides forests between those, which are in need of protection from greenhouse gases and must keep its biodiversity values that should be developed further (Austin et al., 2017).

The approach uses data collected from satellites and measurements from ground. The HCS methodology is based on stratifying vegetation in an area into six classes: High Density Forest, Medium Density Forest, Low Density Forest, Young Regenerating Forest (all of which are considered to be potential HCS forests), or Scrub or Cleared- Open Land. Vegetation is then divided into classes with the help of calibration with carbon stock in the above ground tree biomass and field checks. The next step is to divide land according to what it is being used for. Then HCS forest patches are being analysed and defined if they are suitable areas with forest for protection and further development (Delabre et al., 2018).

### **3.7 Substitute options**

It is said that palm oil can be a cheaper substitute for several other types of oil or even biodiesel. A project was started to look if the use of refined palm oil can be implemented in agricultural diesel engines against normal diesel fuel. Results were quite significant; since it came to light that 100% refined palm oil can indeed be used in KUBOTA diesel engines. The test engine was operating 2000 hours on 75% maximum load without a problem. The only downsides were starting the engine. The high viscosity of palm oil also caused a slightly higher equipment wear. However, since the engine was not optimized for such viscosity of the fuel. With small changes, palm oil has a high potential in auto-moto industry as in form of a biodiesel (Prateepchaikul & Apichato, 2003). Nevertheless, because of the current situation regarding the process of acquiring palm oil, we do not recommend using it as a biodiesel.

Palm oil can also be made into biogas, who could present a real threat to diesel. It is also a real alternative for waste management. Malaysia already made a shift towards renewable energy and with its large palm oil plantations, could really present a real possibility of sustainable biogas production (Aziz, Hanafiah & Gheewala, 2019). The advantage of this idea is that this fuel or energy is only the side product, because the real product is the fruit, from which the oil is made. The leftovers from the plant, all the biomass residues are only used in the production of biogas. On top of that, not only gas can be made, but biodiesel, electricity, heat and even biofertilizer (Harahap, Silveira & Khatiwada, 2019). The last could be used to make a sustainable circular economy, in which the leftovers would be used for fertilizer, who then could be given to the earth, so that the palms have bigger and more fruit. It is reported that this fertilizer made out of palm tree residues have a porous structure, which works as housing for microorganisms. The organic nutrients can be absorbed or attached to these microorganisms. This furthers and stimulates the plant growth by increasing the availability and supply of

nutrients. In an experiment described by Nam et al. (2018), the production of mushroom fertilized by biofertilizer of this kind increased, so that 550 g of mushroom grew in a month.

Palm oil is playing a big role in the replacement of hydrogenated oils in food from Western Europe, since hydrogenated oils contain a big amount of fatty acids, which are considered as unhealthy. However, palm oil is also under the discussion that it contains a high level of saturated fatty acids in comparison to liquid oils. Norway and France are already making palm oil an unpopular choice, since the refining process of the oil makes a higher level of glycidol esters than normal liquid oils have. Lately a lot of the population started searching to change the cheap alternative for the use of liquid oils (Hinrichsen, 2016).

The negatives of palm oil production awareness are not only starting to spread around food and cosmetic industries, but also slowly booming to the general population. A counter measure for the production of the palm oil and usage in various foods and cosmetics is simply changing the attention to the organic and sustainable alternative snacks and cosmetics. However, the first step is making the name palm oil recognizable to the bigger audience possible.

## 4 SOLUTIONS

The question remains if the removal of palm oil is actually fully necessary step. Fats like coconut oil or cocoa butter have the similar or even higher level of fatty acids, but have perceived health advantages over palm oil. Maybe with some improved refining techniques, it is possible to produce palm oil a safer way with less glycidol esters (Hinrichsen, 2016).

There is a way we could all use palm oil, without the deforestation. It has been suggested that we could grow palm trees on *Imperata cylindrica* grasslands. In Asia *Imperata* is an invasive species of grass. It grows on fields, which were already deforested or affected by fires. In 2008, there were 86,000 km<sup>2</sup> of this grassland only in Indonesia, with another 2,000 km<sup>2</sup> in Malaysia. The soil fertility there is not the best, but the climate is perfect for growing palms for palm oil production. The soil would only have to be fertilised. *Imperata* is also a highly flammable type of weed, so it would need to be weeded out by herbicide or manual labour. There is also an option of planting a tree called *Acacia Mangium*, which would throw shade on the *Imperata*. That would weed it out, since *Imperata* need a lot of sun. The only problem with this whole method is that it is expensive, maybe a bit too expensive for the farmers in Indonesia (Swarna Nantha & Tisdell, 2009). There are other areas, where it would be possible to plant palms for palm oil, like Mizoram. This is a state in Northeast India, which has the largest bamboo forest. It is already India's first palm oil plantation, but it has even more potential (Bose, 2019).

Another option that might lessen pressures to open up new plantations is the intensifying of oil palm yields. It is claimed that the theoretical yield in Indonesia and Malaysia is 18.6 tons per hectare. Current studies reveal that yields now remain under 4 tons per hectare, although some Malaysian farms produce 5.5 tons per hectare. It is claimed that there is a possibility of planting higher yielding and resource efficient seedlings or simply by optimization of the whole process, like the timing, dosage and the method of fertilising. Another option for optimizing, that only the ripe fruits would be harvested. Some sources claim, that because of carelessness, it often happens that all fruits are picked, even the unripe ones. The last optimization option would be to replant some old trees. Palm trees use some of their productivity, as they get older, so it would be more productive to plant new ones instead. The problem with this solution is that it does not guarantee further avoidance of deforestation. The yields could be optimized to its full potential, but still the demand is so big, that it could lead to further need for plantation land. The optimization could even lead to less labour. That labour force could then be used for further forest clearing to grow oil palm (Swarna Nantha & Tisdell, 2009).

## 5 CONCLUSION

In this paper, we found out, that palm oil on itself is not bad. Actually, it is quite good, when it comes to how much oil the plant gives per unit of a crop. That means that the palm oil is cheap. It is also oil with a high quality. After latest researches, it can also be used in bio fuel, which means it must be of high quality. But the controversial question still remains is it a good idea to deforest areas the size of small country, our opinion is that deforesting, to create secondary pollution with refining and internal combustion, puts too much stress on environment, from less carbon dioxide filtered, because we deforested an area, to then burn palm is a bad idea from sustainable and environmental point of view.

The only problem is that everybody sees only profit in the plant, but nobody sees what it costs them. They harvest a lot of tropical forest, mostly in an unhealthy way by burning the forest. By doing that they kill and destroy large ecosystems, that also includes many animals; some of them are endangered species like orang-utans. By doing that they get large oil palm plantations fields, where they can grow them to harvest palm oil.

There are ways for a much more eco-friendly palm oil production. We found places, where palm trees, that produce palm oil could grow, but the problem is that clearing that area and making it palm friendly costs a lot. It is money that the poor farmers of Indonesia are not prepared to pay. It is also not the plan of rich farmers, because that would cost them more as just burning a part of the forest down pretty much for free.

They do make profit, a lot of profit, but at the same time the long term costs will even bigger, with less and less forests to filter our air and reduce CO<sub>2</sub> content. The greenhouse effect will become even stronger, eventually running out of control. Preservation of world's forests is important now that is why sustainable production is crucial in doing just that. This sustainable production needs to be controlled by the government. (Luttrell et al., 2018)

As we found out throughout our research, we strongly believe that the main reason for the consequences that the production of palm oil causes lies in the demand of the product itself. It is a must that consumers realize what lies behind the nutrient rich and cheap palm oil that the manufacturers use as additives in many foods, and then sell to the consumers in such high amounts. If the consumers market continues to demand more palm oil each year, more valuable lands will be destroyed because of the high demand and the negative consequences will continue to grow. As said, the first step to better environmentally harmful production of palm oil is the consumer awareness, of the entire negative that comes with cheap palm oil. Consumers' awareness and the problem around deforestation over peatland should spread with the ever-increasing use of palm oil. Consumers demand cheap alternatives, but there is nothing cheap when it comes to environmental damage that production of palm oil causes.

### References

- Austin, K. G., Lee, M. E., Clark, C., Forester, B. R., Urban, D. L., White, L., Kasibhatla, P. S., & Poulsen, J. R. (2017). An assessment of high carbon stock and high conservation value approaches to sustainable oil palm cultivation in Gabon. *Environmental Research Letters*, 12(1), 014005. doi: 10.1088/1748-9326/aa5437
- Astari, A. J., & Lovett, J. C. (2019). Does the rise of transnational governance “hollow-out” the state? Discourse analysis of the mandatory Indonesian sustainable palm oil policy. *World Development*, 117, 1-12. doi: 10.1016/j.worlddev.2018.12.012

- Aziz, N. I. H. A., Hanafiah, M. M., & Gheewala, S. H. (2019). A review on life cycle assessment of biogas production: Challenges and future perspectives in Malaysia. *Biomass and Bioenergy*, 122, 361-374. doi: 10.1016/j.biombioe.2019.01.047
- Bose, P. (2019). Oil palm plantations vs. shifting cultivation for indigenous peoples: Analyzing Mizoram's New Land Use Policy. *Land Use Policy*, 81, 115-123. doi: 10.1016/j.landusepol.2018.10.022
- Butler, A. R. (2011). Could palm oil help save the Amazon? *Monograby news & inspiration from nature frontline*. Retrieved from <https://news.mongabay.com/2011/06/could-palm-oil-help-save-the-amazon/>
- Carlson, K. M., Curran, L. M., Asner, G. P., Pittman, A. M., Trigg, S. N., & Marion Adeney, J. (2012). Carbon emissions from forest conversion by Kalimantan oil palm plantations. *Nature Climate Change*, 3(3), 283-287. doi: 10.1038/nclimate1702
- Craft, C. (2016). *Creating and Restoring Wetlands: From Theory to Practice*. Oxford: Elsevier.
- Delabre, I., Dodson, A., Lyons-White, J. and Lam, J. (2018). *The use of the High Conservation Value (HCV) and High Carbon Stock (HCS) approaches by palm oil companies assessed on SPOTT*. Retrieved from <https://www.spott.org/wp-content/uploads/sites/3/2018/05/HCV-HCS-approaches-palm-oil-companies-v1.2.pdf>
- Edem, D. O. (2002). Palm oil: Biochemical, physiological, nutritional, hematological and toxicological aspects: A review. *Plant Foods for Human Nutrition*, 57(3-4), 319-341. doi: 10.1023/A:1021828132707
- Gatti, R. C., Liang, J., Velichevskaya, A., & Zhou, M. (2018). Sustainable palm oil may not be so sustainable. *Science of the Total Environment*, 652, 48-51. doi: 10.1016/j.scitotenv.2018.10.222
- Harahap, F., Silveira, S., & Khatiwada, D. (2019). Cost competitiveness of palm oil biodiesel production in Indonesia. *Energy*, 170, 62-72. doi: 10.1016/j.energy.2018.12.115
- Haslenda, H., & Jamaludin, M. Z. (2011). Industry to Industry By-products Exchange Network towards zero waste in palm oil refining processes. *Resources, Conservation and Recycling*, 55(7), 713-718. doi: 10.1016/j.resconrec.2011.02.004
- Hidayat, N. K., Offermans, A., & Glasbergen, P. (2017). Sustainable palm oil as a public responsibility? On the governance capacity of Indonesian Standard for Sustainable Palm Oil. *Agriculture and Human Values*, 35(1), 223-242. doi: 10.1007/s10460-017-9816-6
- Hinrichsen, N. (2016). Commercially available alternatives to palm oil. *Lipid Technology*, 28(3-4), 65-67. doi: 10.1002/lite.201600018
- Hooijer, A., Page, S., Canadell, J. G., Silvius, M., Kwadijk, J., Wösten, H., & Jauhiainen, J. (2010). Current and future CO2 emissions from drained peatlands in Southeast Asia. *Biogeosciences*, 7(5), 1505-1514. doi: 10.5194/bg-7-1505-2010
- Johnson, A. (2019). The Roundtable on Sustainable Palm Oil's national interpretation process in Ecuador: "Fitting" global standards into local contexts. *Journal of Rural Studies*, 71, 125-133. doi: 10.1016/j.jrurstud.2019.02.013
- Knoke, I. & Inkermann, H. (2015). *Palmöl - der perfekte Rohstoff?* Retrieved from <https://www.suedwind-institut.de/files/Suedwind/Publikationen/2015/2015-22%20Palmoel%20eine%20Industrie%20mit%20verheerenden%20Folgen.pdf>
- Koh, L., & Wilcove, D. (2008). Is oil palm agriculture really destroying tropical biodiversity? *Conservation Letters*, 1(2), 60-64. doi: 10.1111/j.1755-263X.2008.00011.x

- Luttrell, C., Komarudin, H., Zrust, M., Pacheco, P., Limberg, G., Nurfatriani, F., Wibowo, L. R., Hakim, I., & Pirard, R. (2018). Implementing sustainability commitments for palm oil in Indonesia: Governance arrangements of sustainability initiatives involving public and private actors. *CIFOR Working Paper no. 241*. doi: 10.17528/cifor/006884
- Mahat, S. B. A. (2012). *The palm oil industry from the perspective of sustainable development: A case study of Malaysian palm oil industry*. Retrieved from <https://core.ac.uk/download/pdf/60541187.pdf>
- Mba, O. I., Dumont, M. J., & Ngadi, M. (2015). Palm oil: Processing, characterization and utilization in the food industry: A review. *Food Bioscience*, 10, 26-41. doi: 10.1016/j.fbio.2015.01.003
- Moreno-Peñaranda, R., Gasparatos, A., Stromberg, P., Suwa, A., Pandyaswargo, A. H., & Puppim de Oliveira, J. A. (2015). Sustainable production and consumption of palm oil in Indonesia: What can stakeholder perceptions offer to the debate? *Sustainable Production and Consumption*, 4, 16-35. doi: 10.1016/j.spc.2015.10.002
- Nam, W. L., Phang, X. Y., Su, M. H., Liew, R. K., Ma, N. L., Rosli, M. H. N. B., & Lam, S. S. (2018). Production of bio-fertilizer from microwave vacuum pyrolysis of palm kernel shell for cultivation of Oyster mushroom (*Pleurotus ostreatus*). *Science of the Total Environment*, 624, 9-16. doi: 10.1016/j.scitotenv.2017.12.108
- Padfield, R., Drew, S., Syayuti, K., Page, S., Evers, S., Campos-Arceiz, A., Kangayatkarasu, N., Sayok, A., Hansen, S., Schouten, G., Maulidia, M., Papargyropoulou, E., & Tham, M. H. (2016). Landscapes in transition: an analysis of sustainable policy initiatives and emerging corporate commitments in the palm oil industry. *Landscape Research*, 41(7), 744-756. doi: 10.1080/01426397.2016.1173660
- Pesqueira, L., & Glasbergen, P. (2013). Playing the politics of scale: Oxfam's intervention in the Roundtable on Sustainable Palm Oil. *Geoforum*, 45, 296-304. doi: 10.1016/j.geoforum.2012.11.017
- Pirker, J., Mosnier, A., Kraxner, F., Havlík, P., & Obersteiner, M. (2016). What are the limits to oil palm expansion? *Global Environmental Change*, 40, 73-81. doi: 10.1016/j.gloenvcha.2016.06.007
- Prateepchaikul, G., & Apichato, T. (2003) Palm oil as a fuel for agricultural diesel engines: Comparative testing against diesel oil. *Songklanakarinn Journal of Science and Technology*, 25(3), 317-326. Retrieved from <http://www.thaiscience.info/Journals/Article/SONG/10462352.pdf>
- Ruysschaert, D., & Salles, D. (2014). Towards global voluntary standards: Questioning the effectiveness in attaining conservation goals: The case of the Roundtable on Sustainable Palm Oil. *Ecological Economics*, 107, 438-446. doi: 10.1016/j.ecolecon.2014.09.016
- Sumathi, S., Chai, S. P., & Mohamed, A. R. (2008). Utilization of oil palm as a source of renewable energy in Malaysia. *Renewable and Sustainable Energy Reviews*, 12(9), 2404-2421. doi: 10.1016/j.rser.2007.06.006
- Swarna Nantha, H., & Tisdell, C. (2009). The orangutan-oil palm conflict: economic constraints and opportunities for conservation. *Biodiversity and Conservation*, 18(2), 487-502. doi: 10.1007/s10531-008-9512-3
- Yusoff, S. (2006). Renewable energy from palm oil - innovation on effective utilization of waste. *Journal of Cleaner Production*, 14(1), 87-93. doi: 10.1016/j.jclepro.2004.07.005

- Vitt, D. H. (2008). Peatlands. In S. E. Jørgensen & B. D. Fath (Eds.), *Encyclopedia of Ecology*, 2656-2664. Academic Press. doi: 10.1016/B978-008045405-4.00318-9
- Wicke, B., Sikkema, R., Dornburg, V., & Faaij, A. (2011). Exploring land use changes and the role of palm oil production in Indonesia and Malaysia. *Land Use Policy*, 28(1), 193-206. doi: 10.1016/j.landusepol.2010.06.001
- Yapp, B., Struebig, M., Paoli, G., & Koh, L. (2010). Mitigating the biodiversity impacts of oil palm development. *CAB Reviews: Perspectives in Agriculture, Veterinary Science, Nutrition and Natural Resources*, 5(19), 1-11. doi: 10.1079/PAVSNR20105019

## Contact information

### **Matevž Obrecht**

University of Maribor, Faculty of Logistics  
Mariborska cesta 7, 3000 Celje, Slovenia  
E-mail: matevz.obrecht@um.si  
ORCID: 0000-0001-8301-7382

### **Domen Keblič**

University of Maribor, Faculty of Logistics  
Mariborska cesta 7, 3000 Celje, Slovenia  
E-mail: domen.kebljic@student.um.si  
ORCID: 0000-0002-9528-1743

### **Timitej Zorman**

University of Maribor, Faculty of Logistics  
Mariborska cesta 7, 3000 Celje, Slovenia  
E-mail: timitej.zorman@student.um.si  
ORCID: 0000-0002-0916-3717

### **Mark Kmetec**

University of Maribor, Faculty of Logistics  
Mariborska cesta 7, 3000 Celje, Slovenia  
E-mail: mark.kmetec@student.um.si  
ORCID: 0000-0003-3147-2644

### **Izidor Škrbot**

University of Maribor, Faculty of Logistics  
Mariborska cesta 7, 3000 Celje, Slovenia  
E-mail: izidor.skrbot@student.um.si  
ORCID: 0000-0003-3147-2644

doi: 10.7441/dokbat.2019.100



# CHANGES IN THE REPRODUCTION BEHAVIOUR OF THE POPULATION AND THEIR IMPACT ON THE LABOUR MARKET IN THE SLOVAK REPUBLIC

*Katarína Škrovánková, Júlia Kostrová, Patrik Bulko*

## **Abstract**

The paper deals with changes in the reproductive behaviour of the population and its impact on the labour market in the Slovak Republic. The main aim of the paper is to identify changes in the reproductive processes of the population and their impact on the labour force in the labour market in the Slovak Republic through the application of mathematical-statistical methods. The intention is to point out the negative demographic development that can cause labour shortages in the labour market. The contribution consists of several parts. In the theoretical part, we focus mainly on the definition of basic terms and analysis of demographic development in the Slovak Republic. The analytical part of the paper pays attention to the study of dependence between selected demographic indicators and labour market indicators. This article should be point to high causal dependence between population decline and its negative impact in the development of the labour force on the labour market in the Slovak Republic. According to several surveys carried out is likely that the demographic development will not be favourable, which will be reflected on the labour market, because of the increase of a worker shortage. The conclusion of the paper is devoted to the evaluation of the obtained results and to suggestions and recommendations on this issue.

*Keywords: reproductive behaviour of population, labour force, labour market, Slovak Republic*

## **1 INTRODUCTION**

Population aging is becoming an increasingly discussed topic, not only in the social but also in the economic field. At present, the population ageing is growing at a high rate and is thus becoming a threat to several areas of society's life, including the labour market. Considering that the aging process is not a short-term demographic process, its effects can be influenced in a timely manner by measures that will contribute to addressing its negative impact, as aging cannot be seen only as a negative social phenomenon. In the Slovak Republic, the negative consequences of population aging on the labour market are mentioned especially in the future time, in the spite of fact that the shortage of workers in some sectors of national economy is already evident. However, it is necessary to reflect on this issue already today, because it will be necessary to prepare the labour market for the possible shortage of labour force. It is for this reason timely response and the application of effective political tools, which can contribute to the elimination of these negative consequences. The result of these measures can lead to the life quality improvement in our society. The aim of the article is to identify changes in the reproductive behaviour of the population and their impact on the amount of labour force on the labour market in the Slovak Republic, and to propose recommendations to solve the identified problems.

## **2 THEORETICAL BACKGROUND**

Favourable demographic development is one of the most important prerequisites for the successful development of each country's national economy. The issue of demographic changes and the situation on the labour market in society is becoming a subject of interest not only for

professionals but also for the general public. Given the timeliness of the issue, we therefore consider it important to pay attention to research in this area. In this way, we can contribute to addressing the many negative impacts that are already a challenge for our society.

## **2.1 Reproductive behaviour in the Slovak Republic**

Since time immemorial, society has been interested in the size and structural composition of the country's population. Interest in this issue arises mainly because the population and its structural composition is perceived as a source of economic and political power of the state (Grmanová, 2018). The reproductive behaviour of the population is a fundamental demographic process that affects several areas of society. The most important demographic processes of the population's reproductive behaviour without a doubt include fertility, birth rate, but also mortality and abortion (Lundquist, 2015).

Fertility and natality are considered as key demographic processes of population recovery. While fertility is defined as the ability of a woman and a man to conceive a child, natality is the process of childbirth (Klufová & Poláková, 2010). Mortality and abortion, on the other hand, are considered demographic processes that lead to population decline. While abortion is the process of natural or artificial termination of the life of the unborn individual, mortality can be referred to as the process of termination of the individual's life (Klufová & Poláková, 2010). The outcome of the abovementioned processes of population reproduction behaviour is the natural increase of the population, based on the monitoring of fertility and mortality processes. It is a basic demographic indicator expressing changes in the reproductive behaviour of the population, resulting in either a natural increase or a natural decline in population (Toušek, 2008).

In comparison with the EU member states, the Slovak Republic is experiencing a relatively favourable demographic development. However, it has become one of the European countries with an aging population in recent years as regards the age structure of the population. However, in terms of monitoring the processes of population reproductive behaviour, Slovakia is experiencing a natural increase in population (Vaňo, 2015).

Bleha (2013), based on several researches, draws attention to a scenario where he expresses concern about population development, which should occur after 2030. He states that by 2030 there will be a slight increase in the population in Slovakia, but in the following period a more significant decline in population. Káčerová (2015) draws attention to the fact that a change in the reproductive behaviour of the population is influenced by several factors, such as different view of family, social and economic background. With the change of priorities comes a change in preferences, where most young people postpone the founding of a family and prefer career growth and comfort.

Several world demographic surveys point out on the global problem of adverse population development. The most significant problems associated with the negative reproductive behaviour in the population have been identified in the North American states, but also in the vast majority of European countries. On the contrary, economically lagging countries in Africa have been struggling with overpopulation and food shortages for a long time (Lesthaeghe, 2004). The reason for the unfavourable demographic development in economically developed countries is precisely changes in the lifestyle of the population in the form of growth of material demands. On the contrary, the population in economically lagging countries considers reproduction to be a natural part of their being, regardless of social and economic status (Lesthaeghe, 2004; Surkyn, 2004; Mládek, 2014).

Countries such as Romania, Bulgaria, but also Estonia and Croatia have experienced and the most significant problems in the population development in recent years. Regarding of

monitoring of the live births indicator, only in the V4 countries, Spain, Ireland, Austria, Germany or Slovenia increased in the period 2000 - 2016. The analysis of mortality during the period points out, that the number of deaths increased in the vast majority of European countries. Among the countries where the number of deaths decreased, in addition to the Slovak Republic and the Czech Republic is also Hungary and Ireland. Positive increase in natural increase of population in individual European countries can be seen only in the countries such as Spain, France, Belgium, Netherland, Luxemburg or V4 countries during the monitored period 2000 - 2016 (Grmanová, 2018).

## **2.2 Labour market and national economy in the Slovak Republic**

Economic theory defines the labour market as a place where there is a meeting of employers represented by the offer and demand, which is represented by a potential labour force. The labour market situation is very closely linked to demographic trends. The labour shortage resulting from unfavourable demographic development is causing serious economic but also social problems in the national economy (Tuleja, 2006). The national economy can be described as a set of activities that are carried out within the economy of the country by citizens and businesses. The main function of the national economy is to ensure the economic, technological and social progress of the country (Vyšňovská & Mokaňová, 2006).

Part of the national economy of the country are individual sectors of the labour market, which are divided into four groups:

- a) primary sector where we include work activities such as mining, agriculture, forestry and energy;
- b) the secondary sector, which refers to the primary sector, where activities such as manufacturing and construction are classified;
- c) tertiary sector, respectively service sector including trade, transport and other services;
- d) quaternary sector, forming a field of activities such as science, technology, health, education, etc. (Rievajová, 2016).

As indicated in the previous section, demographic prospects of Slovakia are not very favourable. Several authors of scientific publications draw attention to the potential shortage of labour in several sectors of the national economy.

The labour market situation is largely derived from demographic developments. Lubyová, (2015) notes that despite the relatively stable demographic development, the Slovak labour market is less efficient in comparison with other European countries with unfavourable demographic development. There is talk of a positive increase in employment, but there are still problematic regions with high rates of long-term unemployment. The question therefore remains as to how the labour market situation will evolve after the demographic breakthrough in which the Slovak population is expected to find itself in 2030. Vojtovič and Krajňáková (2017) also point out in their researches a change in the priorities of the workforce entering the labour market. It is important to realize that the generations entering the labour market are much smaller in number and have very different characteristics, preferences and demands. There may be a problem especially in the area of interpersonal relations in the workplace.

Already today, many companies are introducing new technological procedures in Slovakia to replace human work, while others are betting on the gradual application of age management in companies, but as stated by Radvanský (2010), there are very few such companies. The introduction of technology into the work process can be afforded only by large companies with sufficient capital and in terms of age management, the majority of employers in Slovakia have

very little knowledge of the use of this alternative. For this reason, too, the employer may find himself in a situation of labour shortage in the near future.

Negative forecasts in the form of labour shortages is possible to solve through the technology implementation into the work processes, but also through the effective application of age management in companies or by active labour market measures through the implementation of the European Union's concept of Active Ageing (Foster, 2014).

### 3 GOAL AND METHODOLOGY

The main aim of the paper is to identify changes in the reproductive processes of the population and their impact on the labour market in the Slovak Republic through the application of mathematical-statistical methods. The intention is to point out the negative demographic development that can cause labour shortages in the labour market. In order to fulfil the main objective of the paper, the following partial objectives have been defined:

- 1) To analyse the current and forecasted reproductive behaviour of the population in the Slovak Republic.
- 2) To analyse and evaluate the current situation and development of the situation on the labour market in terms of demographic development.
- 3) To elaborate data for the assessment of the impact of the reproductive behaviour of the population on the change in the number of labour force in the conditions of Slovakia through regression and correlation analysis, through the software MS Excel and Statistica.
- 4) Evaluate the identified problems and propose measures to address emerging problems.

The following calculations and methods are used in the methodological procedure:

#### Natural increase

$$Ni = N - D \quad (1)$$

(Ni – natural increase, N – number of live births, D – number of death)

#### Net migration

$$Nm = I - E \quad (2)$$

(Nm – net migration, I – number of immigrants, E – number of emigrants)

#### Total Increase

$$Ti = Ni + Nm \quad (3)$$

(Ti – total increase, Ni – natural increase, Nm – net migration)

**Regression and correlation analysis** are a method that we will use to identify the intensity of the impact between the selected demographic indicator and the labour market indicator, using a linear regression model. Linear regression model function:

$$y' = b_0 + b_1x_j \quad (4)$$

( $b_0$  = locating constant,  $b_1$  = regression coefficient,  $y_j$  = value of dependent variable,  $x_j$  = value of independent variable)

## 4 RESULTS

In the following part of the paper, we will pay attention to the analysis of the current situation in the field of research.

### 4.1 Reproductive behaviour of the population in the Slovak Republic

Figure 1 shows the population development in the conditions of the Slovak Republic. We can see that the population development during the monitored period as well as the forecast period shows a slight increase. The exception should be the year 2021, where the total population should drop slightly. By 2022, the population is expected to increase only slightly to around 5.52 million.

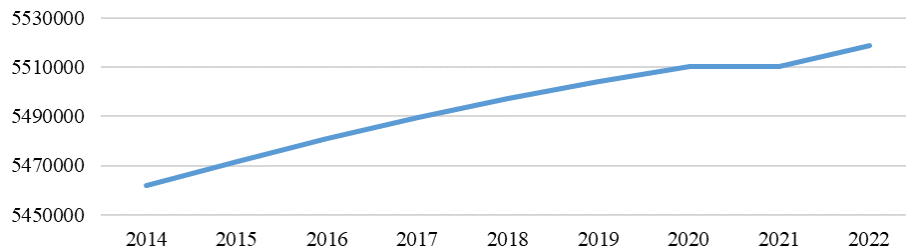

Fig. 1 – Population of the Slovak Republic. Source: PUSAV (2018)

Figure 2 demonstrates data on the reproductive behaviour of the population in the Slovak Republic. As can be seen from the graph, the reproductive behaviour of the population during the monitored and forecasted period changed most significantly, especially in the number of births, where it gradually decreases. On the contrary, it can be stated that during the monitored and forecasted period there is also a decrease in natural increase and total population growth in the Slovak Republic.

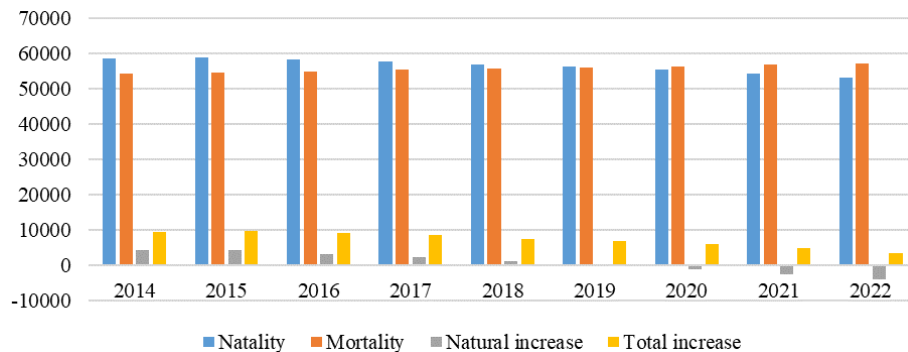

Fig. 2 – Reproductive behaviour of the population in the Slovak Republic. Source PUSAV (2018)

As can be seen from the monitored data, it can be confirmed that demographic trends and forecasts indicate an unfavorable situation.

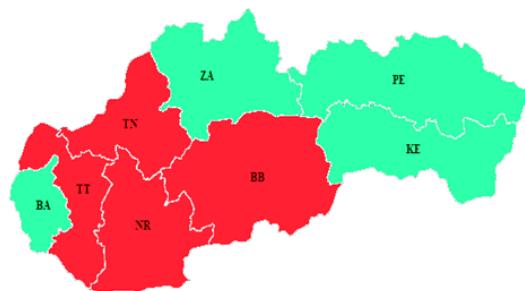

Fig. 3 – Natural increase of the population in NUTS 3 regions of Slovak Republic. Source: Eurostat (2019)

Figure 3 shows the state of natural population growth in individual NUTS 3 regions in the Slovak Republic. The values of natural increase of regions are measured for the last published period, which is the year 2018. Territorial units marked with green are regions, which in 2017 recorded a positive natural increase of population, i.e. the number of children born was higher than the number of deaths. Regions with a positive natural increase include the Bratislava Region with an increase of 2305 inhabitants, the Žilina Region with an increase of 782 inhabitants, the Prešov Region with an increase of 2703 inhabitants and the Košice Region with a natural increase of 1681 inhabitants. On the contrary, negative natural increase was identified in Trnava region with a decrease of 351 inhabitants, Trenčín region with a decrease of 1005 inhabitants, Nitra region with a decrease of 1706 inhabitants and Banská Bystrica region with a decrease of 894 inhabitants. Most children were born in the Prešov region in the reference year, the least in the Trenčín region. The highest mortality was identified in the Nitra region, while the lowest mortality was recorded in the Trnava region.

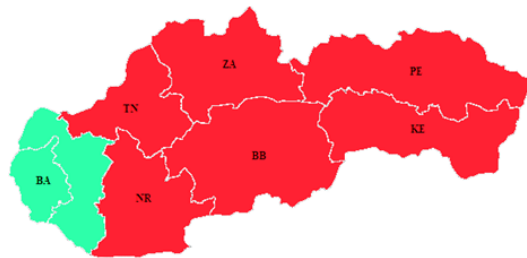

Fig. 4 – Net migration of the population in NUTS 3 regions of Slovak Republic. Source: Eurostat (2019)

Figure 4 demonstrates the population migration balance in individual NUTS 3 regions in the Slovak Republic. Only two territorial units recorded an increase in the migration balance (prevalence of immigrants), namely the Bratislava Region in the form of an increase of 5845 immigrants and the Trnava Region with an increase of 1134 immigrants. On the other hand, all other self-governing regions are regions with a negative migration balance, i.e. regions with a predominance of emigration.

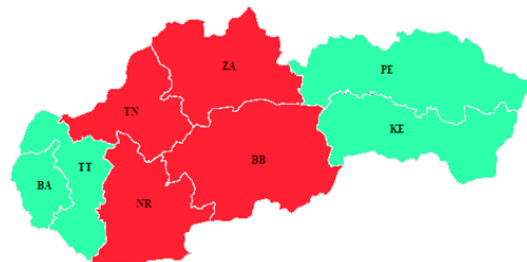

Fig. 5 – Total increase of the population in NUTS 3 regions of Slovak Republic. Source: Eurostat (2019)

Figure 5 demonstrates the value of total population growth in individual NUTS 3 regions in the Slovak Republic. Positive values of total population growth were identified in four territorial units, namely in the Bratislava region, which, thanks to the high value of the migration balance, reaches the highest values of total population growth. Positive values of the total increase were also recorded by the Trnava Region, the Prešov Region and the Košice Region due to the high values of natural increase in the population. On the contrary, territorial units with negative values of total increase of population include Trenčín region, Banská Bystrica region, Žilina region and Nitra region, which belongs to regions with the highest negative value of total increase (decrease) of population. As of 2018, the Banská Bystrica Region recorded the value of total population growth in the form of a decrease of 2557 inhabitants, in comparison with the year 2017.

## 4.2 Labour market in the Slovak Republic

Most authors dealing with the labour market situation point to a favourable situation in the form of increasing employment in Slovakia, but despite its gradual increase, the country is significantly lagging behind in comparison with other developed countries. Figure 6 demonstrates data on both employment and unemployment rates in the Slovak Republic. It can be noted that during the period under review and forecasted, there is a positive increase in the employment rate and, naturally, in the unemployment rate. By 2022, the unemployment rate is projected to fall below 5%.

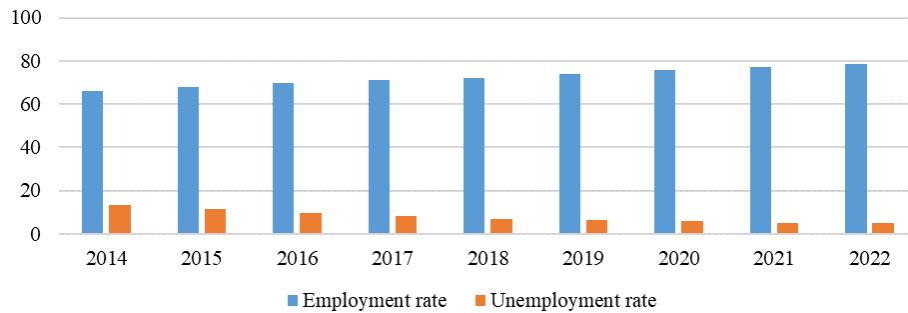

Fig. 6 – Employment rate and unemployment rate in the Slovak Republic. Source: PUSAV (2018)

Figure 7 represents data on the development of the volume of labour and jobs in the Slovak Republic.

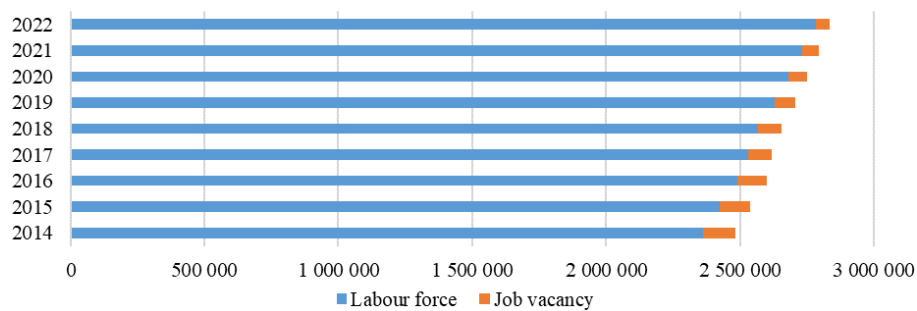

Fig. 7 – Labour force and vacancies in the Slovak Republic. Source: PUSAV (2018)

In terms of monitoring the development of the number of workers on the labour market, an increase was identified during the monitored and forecasted period. On the other hand, there should be a gradual decline in the situation regarding the creation of new jobs. By 2022, the Slovak labour market is expected to have less than 50,000 vacancies.

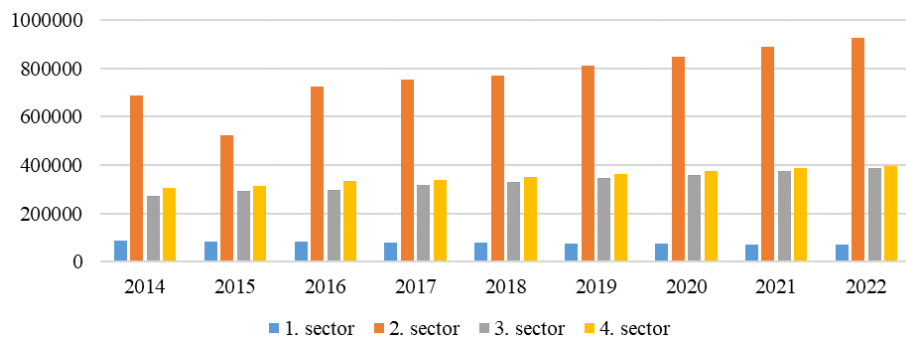

Fig. 8 – Labour force in the sectors of national economy of the Slovak Republic. Source: PUSAV (2018)

Figure 8 shows the situation of jobs on the labour market in the Slovak Republic from the perspective of individual sectors of the country's national economy. It can be noted that the

number of workers in the primary sector should decrease by 2022. In the secondary sector, on the other hand, we can expect the most significant increase in the number of workers. This is mainly due to the prevalence of industry-oriented enterprises. In the tertiary and quaternary sectors, by contrast, no significant change in the volume of labour is expected.

### 4.3 Evaluation of current trend in demography and labour market in the Slovak Republic

Table 1 provides an overview of current trends in the demographic development of the population and trends in the labour market in the Slovak Republic.

Tab. 1 – Current Trends in Demography and Labour Market in the Slovak Republic. Source: own research

IDENTIFIED CHANGES	
DEMOGRAPHIC CHANGES	CHANGES IN THE LABOUR MARKET
Overall population growth	Increasing employment
Decrease in natural population growth	increase in the number of employees
decrease in natality	increase in the number of new jobs
decrease in mortality	Persistent (relatively high) long-term unemployment
Decrease of total increase	

Based on the monitoring of the development and forecasts of statistical data, several changes have been identified, which affect the examined issue. The most significant demographic changes include, in particular, a decline in birth rates and mortality rates, as well as a decline in the overall population increase, which may cause labour shortages in the future. On the other hand, the most significant change in the labour market in the Slovak Republic can be seen primarily in the positive reduction in unemployment, but also in the persisting long-term unemployment rate.

### 4.4 Impact of reproductive behaviour of the population on the labour market in the Slovak Republic

In the following part of the paper we will try to evaluate the level of the impact of the selected demographic indicator on the selected indicator of the labour market. In order to fulfil our topic, we chose to examine the impact of reproductive behaviour of the population on the number of workers on the labour market. We included in the regression analysis as an independent variable x - the total population growth, and as a dependent variable y - the number of workers on the labour market. To calculate the regression and correlation analysis, we used a time horizon between 2014 and 2022.

Tab. 2 – Total population increase and number of workers in the Slovak Republic. Source: PUSAV (2018)

Year	Total increase	Number of workers on the labour market
2014	9 685	2 363 000
2015	9 949	2 424 000
2016	9 265	2 492 100
2017	8 655	2 530 700
2018	7 618	2 566 700
2019	6 935	2 629 530
2020	6 099	2 680 940
2021	4 869	2 732 350
2022	3 601	2 783 760

Table 2 demonstrates data on total population growth as well as data on the number of workers in the Slovak Republic. It can be noted that during the monitored period 2014 - 2019 there was a decrease in the total population growth in the Slovak Republic. On the other hand, as regards the number of workers on the labour market, it gradually increased by almost 266,530 workers



during the period under review. In both cases, we expect a continuing trend of development, i.e. in the case of total population growth, a significant decrease is expected:

Tab. 3 – Regression and correlation analysis. Source: PUSAV (2018)

Regression Statistics	
Multiple R	0,9709570
R Square	0,9427575
Adjusted R Square	0,9345800
Standard Error	36069,671
Observations	9

ANOVA	df	SS	MS	F	Significance F
Regression	1	1,49991E+11	1,4991E+11	115,2868	1,33615E-05
Residual	7	9107148586	1301021227		
Total	8	1,59098E+11			

	Coefficients	Standard Error	t Stat	P-value	Lower 95%	Upper 95%	Lower 95,0%	Upper 95,0%
Intercept	303426,114	44150,95942	68,72466994	3,63E-11	29298,684	31386,543	29298,684	31386,
X Variable 1	-6,1570295	5,734313241	-10,7371699	1,34E-05	-75,12979164	-48,010799	-75,129791	-48,01

In the application of the regression analysis method we tried to identify and explain the dependence, respectively. The impact of natural population growth on the development of the number of workers on the labour market in the Slovak Republic. The regression function has the form  $y = -6,157x + 3034260,114$  that means that in the case of zero natural population growth the total number of jobs would reach approximately 3 million workers. Indicator X Variable  $b_1 = -6,157$  explains that if natural population growth decreases by one unit of measure, there will be a 6.1% decrease in the total number of workers. In both cases, the P-value is less than 0.05, which means that both the locating constant and the regression coefficient are statistically significant. In addition, the regression analysis output points to a 97% confidence interval for  $b_0$  and  $b_1$ . Therefore, if the natural population increase was reduced by 1 percentage point, the total number of workers would also be reduced by approximately 31 386 to 29 298 dues to the retirement of workers who reached retirement age. It can therefore be argued that natural population growth has a significant impact on the workforce. The correlation coefficient (Multiple R) is 0.97. This value is close to 1 and thus represents a very strong relationship between the indicators examined. The value of the determination coefficient (R Square) indicates that the chosen regression line explains the variability between the data to 94%.

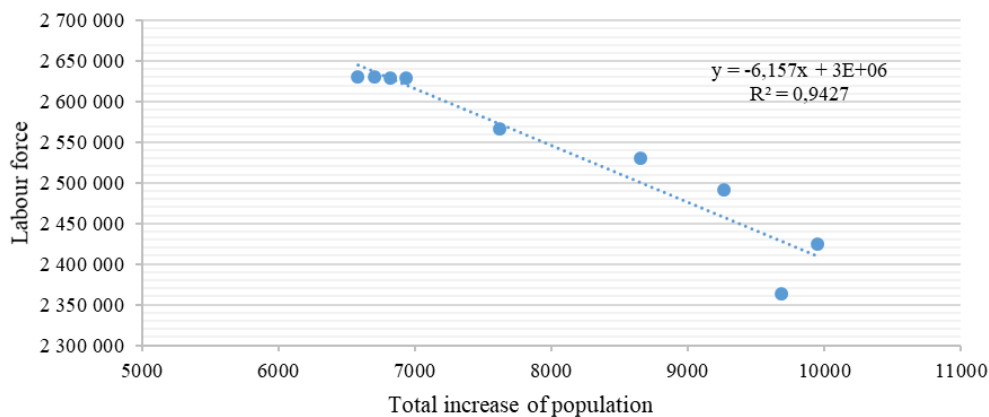

Fig. 9 – Regression analysis. Source: PUSAV (2018)

Figure 9 shows the overall conclusion of the regression analysis. This means that the development of total population growth in the population affects the amount of labour force on the labour market in the Slovak Republic.

#### **4.5 Suggestions and recommendations for solving problems of the examined issue**

Through the application of the method of regression analysis, we tried to verify the dependence between the selected demographic indicator and the selected labour market indicator, in order to point out the impact and connection of demographic development with the development of the situation on the labour market. We tried to prove the impact of the total increase (population decrease) on the workforce in the Slovak Republic. From the results of the regression analysis we identified a relatively high causal dependence between the investigated indicators. population shrinkage significantly affects the labour force on the labour market. According to several forecasts, it is likely that demographic developments will not be favourable, which will ultimately be reflected in the labour market in the form of the onset of a labour deficit.

The emerging workers' deficit is likely to be addressed primarily through the introduction of automation of the work process and replacement of human force with technologies. However, this principle of substitution of labour force by machines in the conditions of the Slovak Republic has so far been applied only in the industry. However, the soft sectors of the national economy, such as trade, services, health and education, are lagging behind. Sooner or later, the adverse demographic situation will require several changes in the demand for services and goods. In particular, demand for specialized medical care and social care is expected to increase.

On the basis of the analyses carried out and the impact of demographic indicators on the development of the labour market situation, we decided to propose several recommendations:

- a) encouraging businesses to introduce new technologies into the workforce;
- b) supporting the application of age management and flexible forms of employment, for effective management of the workforce in enterprises, and preparing for the emergence of a potential shortage of workers;
- c) support in the field of informatization regarding active aging and exploitation of the potential of older people in order to increase the standard of living as well as economic activity of the society.

## **5 DISCUSSION AND CONCLUSION**

As we have already mentioned, given that the population is aging relatively quickly in the future, the labour market should adapt working conditions so that the people leaving the labour market are willing to continue working. It is therefore essential to think about the quality of health and social services. In the context of the retention of older workers in the labour market, it is also necessary to consider the use of age management in enterprises, which could help employers to prepare for the shortage of workers in the labour market. Employers should think about how to prepare a suitable post-productive job so that the necessary number of jobs in the company is also covered. It should be pointed out that age management is not just about older people. Regardless of the employee's age and ability, it can be applied in practice to the flexible employment of women on maternity leave or other disadvantaged job seekers. However, the question remains to what extent is the state able to strengthen the policy of active aging and to what extent it is able to motivate the elderly to remain in the work process. The greatest motivation for seniors should be, above all, economic improvement, active ageing and social inclusion.

## References

- Bleha, B. (2013). *Prognóza vývoja populačného Slovenskej republiky do roku 2060*. Bratislava: Infostat.
- Eurostat. (2019). *Population*. Eurostat Database. Retrieved from <https://ec.europa.eu/eurostat/data/database>
- Grmanová, E. (2018). *Demografické zmeny a ich vplyv na trh práce*. Trenčín: TnUAD.
- Káčerová, M. (2015). Proces starnutia populácie Slovenska v európskom kontexte. *Slovenská štatistika a demografia*, 25, 44-58. Retrieved from [https://www.researchgate.net/publication/280063336\\_Proces\\_starnutia\\_populacie\\_Slovenska\\_v\\_europskom\\_kontexte](https://www.researchgate.net/publication/280063336_Proces_starnutia_populacie_Slovenska_v_europskom_kontexte)
- Klufová, R., & Poláková, Z. (2010). *Demografické metódy a analýzy: demografie české a slovenské populace*. Praha: Wolters Kluwer.
- Lesthaeghe, R. (2004). Value Orientations and the Second Demographic Transition. *Demographic Research*, 3(3), 45-86. doi: 10.4054/DemRes.2004.S3.3
- Lubyová, M., & Štefánik, M. (2015). *Trh práce na Slovensku 2016+*. Bratislava: Ekonomický ústav Slovenskej akadémie vied.
- Lundquist, H. J. (2015). *Demography – The Study of Human Population*. Illinois: Waveland.
- Mládek, J. (2014). Špecifické črty reprodukčného správania. *Geografický časopis*, 66(2), 133-159. Retrieved from [www.sav.sk/journals/uploads/03101209Pukacova,%20Mladek.pdf](http://www.sav.sk/journals/uploads/03101209Pukacova,%20Mladek.pdf)
- PUSAV. (2018). *Foresight, Analysis and Recommendations*. Bratislava: Institute for Forecasting Slovak Academy of Science. Retrieved from <http://www.prog.sav.sk/sites/default/files/2019-04/pp2018web.pdf>
- Radvanský, M. (2010). *Makroekonomická prognóza vývoja slovenskej ekonomie zameranej na vývoj dopytu po práci*. Retrieved from <http://www.ekonom.sav.sk/uploads/journals/ES07.pdf>
- Rievajová, E. (2016) *Trh práce a politika zamestnanosti*. Bratislava: Ekonóm.
- Surkyn, J. (2004). Value Orientations and the Second Demographic Transition (SDT) in Northern Western and Southern Europe: An Update. *Demographic Research*, 3(3), 45-86. doi: 10.4054/DemRes.2004.S3.3
- Toušek, V. (2008). *Ekonomická a sociální geografie*. Praha: Aleš Čeněk.
- Tuleja, P. (2006). *Základy makroekonomie*. Praha: Computer Press.
- Vaňo, B. (2015). Súčasný a očakávaný populačný vývoj na Slovensku a jeho spoločenské a ekonomické dopady. *Prognostické práce*, 7(3), 273-293. Retrieved from [http://www.prog.sav.sk/sites/default/files/2018-03/Vano\\_PP3\\_clanok\\_doplneny\\_c\\_4.pdf](http://www.prog.sav.sk/sites/default/files/2018-03/Vano_PP3_clanok_doplneny_c_4.pdf)
- Vojtovič, S., & Krajňáková, E. (2017). Struggles of older workers at the labour market. *Economics & Sociology*, 10(1), 319-333. doi: 10.14254/2071-789X.2017/10-1/23
- Vyšňovská, J., & Mokáňová, M. (2006). *Hospodárstvo*. Prešov: Vydavateľstvo Michala Vaška.
- Weller, S. A. (2007). Discrimination, Labour Markets and the Labour Market Prospects of Older Workers. *Work, Employment and Society*, 21(3), 417-437. doi: 10.1177/0950017007080006

## **Contact information**

### **Ing. Katarína Škrovánková**

Alexander Dubček University of Trenčín, Faculty of Social and Economic Relations  
Študentská 2, 91150, Trenčín, Slovak Republic

E-mail: katarina.skrovankova@tnuni.sk

ORCID: 0000-0002-8295-9666

### **Ing. Júlia Kostrová**

Alexander Dubček University of Trenčín, Faculty of Social and Economic Relations  
Študentská 2, 91150, Trenčín, Slovak Republic

E-mail: julia.kostrova@tnuni.sk

ORCID: 0000-0002-0536-0318

### **Ing. Patrik Bulko**

Alexander Dubček University of Trenčín, Faculty of Social and Economic Relations  
Študentská 2, 91150, Trenčín, Slovak Republic

E-mail: patrik.bulko@tnuni.sk

ORCID: 0000-0002-6910-7434

doi: 10.7441/dokbat.2019.101

# THE IMPACT OF SUBSIDIES ON THE REGIONAL PASSENGER RAIL TRANSPORT

*Ondřej Špetík*

## **Abstract**

The passenger rail transport is undergoing changes not only in the Czech Republic but also all over the European Union. Fear of the climate change, significant investments into the railway infrastructure and rolling stock and traffic jams have caused that the railway transport is becoming increasingly more popular. This phenomenon is seen in the long-distance and suburban transport. Nevertheless, the regional railway transport stands apart: the number of passengers decreases. Regions which are responsible for regional railway public services and which have to finance them seek to support them by purchasing new vehicles, establishing integrated regional transport systems or by setting lower fares. Is this effort reflected in the number of passengers? The aim of this paper is to identify whether the subsidy to the rolling stock purchase leads to the passenger growth in the regional railway transport. The methodology used is based on the fixed-effects model of the panel data and the analysis of descriptive statistics of variables. The results indicate that investments into the new rolling stock do not have a significant positive impact on the number of regional railway passengers. The regional railway transport is inferior goods whose demand decreases when consumer income rises. The regional railway transport and the long-distance transport are complementary goods. Investments in railway corridors can make regional transport more attractive.

*Keywords:* transport policy, regional railway transport, subsidy, EU funds, common transport policy

## **1 INTRODUCTION**

The passenger rail transport is undergoing changes not only in the Czech Republic but also all over the European Union. Fear of the climate change, significant investments into the railway infrastructure and rolling stock and traffic jams have caused that the railway transport is becoming increasingly more popular. This phenomenon is seen in the long-distance and suburban transport not only in the Czech Republic but also in most countries of the European Union. Nevertheless, the regional railway transport stands apart: the number of passengers decreases. Regions which are responsible for regional railway public services and which have to finance them seeks to support them by purchasing new vehicles with Wi-Fi connection and air conditioning, estimating integrated regional transport systems or by setting lower fares. This effort is encouraged by the Common Transport Policy of the European Union and by the Czech Transport Policy. Both seek to increase the market share of the railway transport (European Commission, 2011; Ministry of Transport, 2013). One of the ways is gaining subsidies from the European Structural and Cohesion Funds. Is this effort reflected in the number of passengers? Are these investments efficient? The aim of this paper is to identify whether the subsidy to the rolling stock leads to the passenger growth in the regional railway transport. The methodology used is based on the fixed-effects model of the panel data and the analysis of descriptive statistics of variables.

## 2 MOTIVATION

As we have already mentioned before, the growth of the number of passengers in the railway transport is one of the goals of the transport policy. In the next chart, we can see how successful this policy in the Czech Republic is. Since 2011, the number of passengers has increased by 22 million per year (13%).

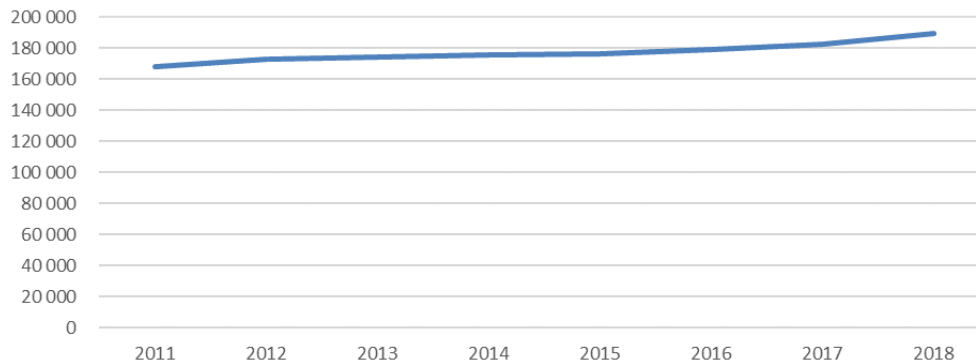

Fig. 1 – The number of train passengers in the Czech Republic. Source: SYDOS (n.d.)

On the other hand, the situation in the regional passenger railway market is entirely different. Stagnation or even decline is present on this market (see the chart below).

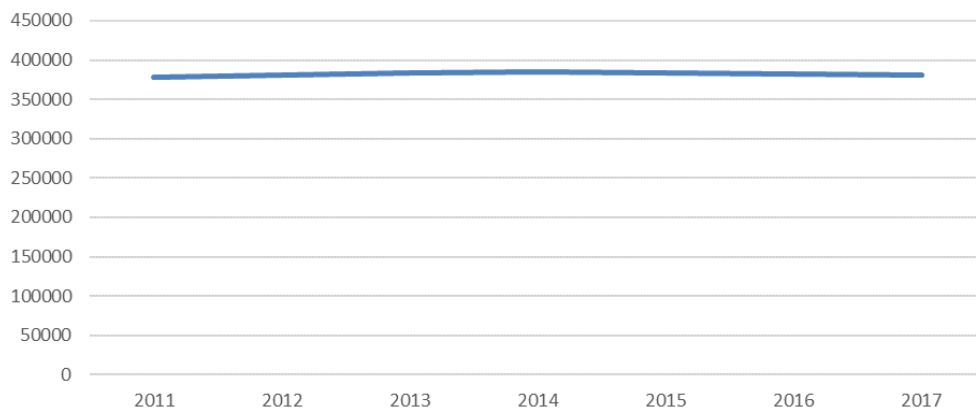

Fig. 2 – The number of passengers travelling within regions (per day). Source: Pohl (2018)

Regions which are responsible for the regional transport seek to reverse the trend. In all evaluated regions, there is an integrated regional transport system which allows the use of one ticket for all transport modes. Passengers can also purchase seasonal tickets which are more cost-effective than previous fares based on kilometres travelled. Moreover, regions aspire to improve the quality of travelling. One way to improve the quality of services is the modernisation of the rolling stock. Subsidies for new rolling stock are one way of promoting the railway transport. In the table below, there is an overview of subsidies.

Tab. 1 – Subsidy to the railway vehicles from EU funds and the total value of investments. Source: own research

<b>Operational Programme</b>	<b>Subsidy</b>	<b>Total value of the investments</b>
Jihovýchod	274 704 560	686 761 400
Severovýchod	612 286 780	1 530 716 950
Severozápad	607 630 807	1 528 696 954
Jihozápad	310 987 487	777 468 717
Střední Čechy	947 507 320	2 368 768 300
Moravskoslezsko	604 318 000	1 174 894 000
OPD	856 510 150	1 219 810 680
<b>Total</b>	<b>4 540 662 933</b>	<b>10 103 911 573</b>

We can see massive investments in the rolling stock. On the chart below we can see results of the investments made.

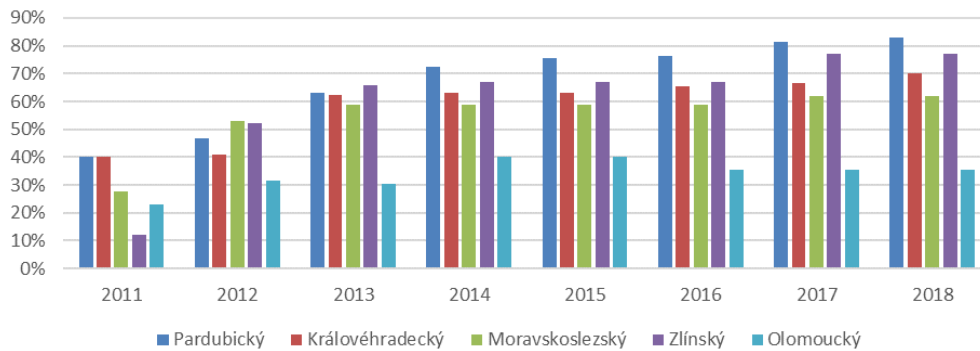

Fig. 3 – The share of the new rolling stock in depicted regions. Source: Czech Railways (2010-2017)

We can see the huge progress of the new vehicles share. Apart from Olomoucký Region, the new rolling stock share is above 60%. As we can see in the chart below, these modernisations do not have changed the trend of the regional railway passenger decline.

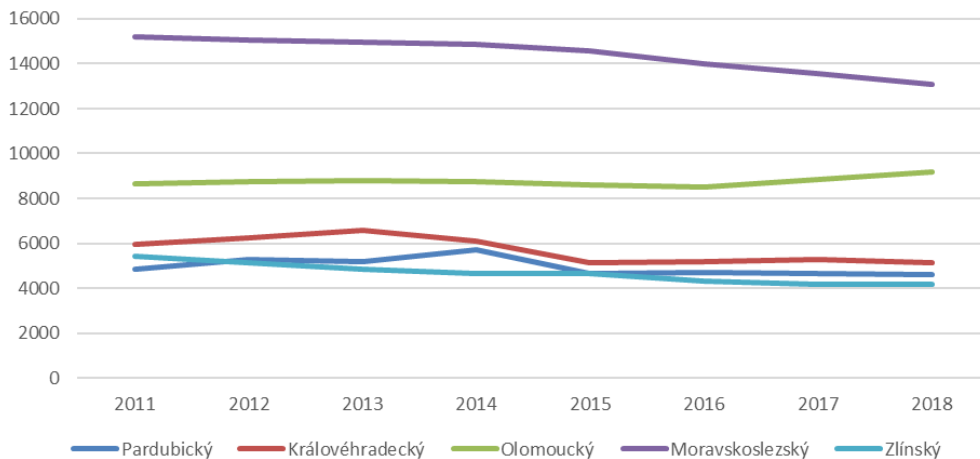

Fig. 4 – The number of passengers travelling within the region (mil. passengers per year). Source: SYDOS (n.d.)

This chart does not indicate the results that subsidies would be inefficient – for this reason it has to be analysed more in detail. Therefore, we developed a model which could bring the answer to the question raised in the introduction.

### 3 LITERATURE REVIEW

The economic literature has discussed the demand for the public transport very carefully. The demand for public transport, Paulley et al. (2006), has analysed the impact of the quality of the service. They do not see enough evidence in the demand that impacts service quality. According to Buehler et al. (2010), increase in quality of railway services, full regional coordination of timetables, fares and services has led to raising number of passengers in Germany. However, they do not analyse each effect separately. Furthermore, Paulley et al. (2006) have also studied income and car ownership effects. Influence of the car ownership is more evident in the demand for the bus travel than for the rail travel, but it is still significant. The estimated income elasticities are between -0.5 to -1.0 in the long run. It has been also mentioned that the average trip length has increased with the growth in the income. The elasticity of the trip length to the income is in the range of 0.1-0.2. According to Rahman and Balijepalli (2016), the demand for the transport is inelastic.

Interesting findings come from open access market regime: despite lower service quality, some train operators can score highly on public satisfaction. This can be done by lower fares (Stead et al., 2019). Problems of financing new rolling stock is addressed by Alexandersson et al. (2008) or by Nash et al. (2019). Authors suggest to have contracts with rolling stock provided by the franchising authority. To sum up, influence of the rolling stock modernisation is not clear. Some authors see positive effect, but on the other hand there are also studies which did not prove significant effect of quality of the service.

#### 4 THEORETICAL BACKGROUND

The number of passengers is set by the demand for transport and the price. The Ministry of Transport and each region have set the price of the passenger transportation. Fares are published in so-called price journals (Price Act 526/1990). The demand for goods is the “number of units per unit of time that consumers purchase at any given price” (Cowie, 2010). Demand for goods  $a$  is influenced by their price  $P_a$ , the price of other goods ( $P_1, P_2, \dots, P_n$ ), tastes  $T$  and the level of income  $Y$ . The neoclassical demand curve entails focusing on the price changes implication on demand, holding the other factor constant that is (Button, 2010):

$$D_a = f(P_a, P_1, P_2, \dots, P_n, T, Y) \quad (1)$$

The demand is a result of consumers expressing their preferences between goods at the relative prices that they face taking into account all money they have available to them (Cowie, 2010). After housing and food, transport represents at about 10 to 15 per cent for households (Button, 2010). The influence of income divided goods into “normal” and “inferior” goods. Normal goods are those where demand increases with the increase in income; inferior goods are those that fall with an increase in the income (Cowie, 2010). The influence of other goods divided them into two categories: substitute and complementary goods. If the price of substitute goods increases, the demand will increase. If the price of complementary goods increases, the demand will decrease (Mankiw, 2009).

#### 5 MODEL SPECIFICATION AND PANEL DATA ANALYSIS

In our model, we look for factors, which can influence the number of passengers in the regional railway transport. This study sample is focused on five regions (i.e. Pardubický, Královéhrdecký, Zlínský, Olomoucký and Moravskoslezský) and the period of time from 2011 to 2018. This sample was selected according to the data availability (for other regions and more extended period data was incomplete). The demand can also be influenced by travel time (Button, 2010) but there are no data for this variable. The study used regression model of panel data to test factors affecting the number of passengers. The data in the paper comes from the Transport Yearbook (SYDOS, n.d.) which is issued by the Ministry of Transport and from press releases of the Czech Railways. Data used in the model is in the table below.

Tab. 2 – Data. Source: own research

Variable	Value
PASSENGER	the number of passengers travelling within the region (in thousands)
NEW	share of new or upgraded vehicles (in %)
LONG_DISTANCE	number of passengers departing from a given region by train to another region; it is a dummy for quality of railway corridors (in thousands)
PRICE	fare price index (there are differences between regions)
POPUL	population living in the region (in thousands)
WAGE	the average monthly gross salary in the region (in CZK)
SUPPLY	a number of train-kilometres in the regional transport in each region (in a million train-kilometres).



The fixed-effects model was chosen as an estimation method. The model is simply a linear regression model in which the intercept terms vary over the individual units  $i$ . This model was chosen due to differences in each region which can be eliminated by fixed effects. We can write this model in the usual regression framework by adding a dummy variable for each unit  $i$  in the model:

$$y_{it} = \sum_{j=1}^N \alpha_j d_{ij} + x'_{it} \beta + \varepsilon_{it} \quad (2)$$

Where  $d_{ij} = 1$  if  $i = j$  and 0 elsewhere. We have a set of  $N$  dummy variables in the model (it represents each region). The parameters  $\alpha_i$  and  $\beta$  can be estimated by ordinary least squares (Verbeek, 2017). If the model fulfils all assumption of error terms, it will be the best linear unbiased estimator (Cipra, 2008). We used this model because an intercept  $\alpha_i$  is used to distinguish between cross-sectional units; therefore, the model does not include the special effects  $\alpha_i$  (regions differ among themselves). Nevertheless, we assume that differences are not random. In the table below, there are results of our model.

Tab. 3 – Results of the model. Source: own research

<b>Depended variable: PASSENGER</b>				
<b>Variable</b>	<b>Value</b>	<b>Standard deviation</b>	<b>P-value</b>	
<b>const</b>	-41042.5	10164.3	0.0004	***
<b>NEW</b>	-54.3201	529.192	0.9189	
<b>LONG_DISTANCE</b>	1.18281	0.400773	0.0062	***
<b>PRICE</b>	-6.07385	24.1410	0.8031	
<b>POPUL</b>	0.0551606	0.0127953	0.0002	***
<b>WAGE</b>	-0.169149	0.0392850	0.0002	***
<b>SUPPLY</b>	2224.67	853.188	0.0143	**
observations		40		
Within R-squared		0.732223		
P-value (F)		4.92e-31		
Joint test on named regressors		3.6245e-007		
F-test		p-value 1-1738e-006		

We provided the Wald test for heteroscedasticity. The null hypothesis means homoscedasticity, which we did not reject; therefore, the model is appropriate.

## 6 DISCUSSION

The number of passengers has been influenced by the supply of transport, wage, number of population and by long-distance transport. The supply has a positive impact on the number of passengers (the higher supplied train connection, the higher number of the passenger) which corresponds to our expectations and to the standard economic literature (e.g. Button, 2010). Increase in wage negatively affects the number of passengers – regional railway transport seems to be inferior goods (this is also following the literature – see, e.g. Button, 2010). The number of populations positively influences the number of passengers. This result is also in line with our expectations – a larger market leads to a higher number of passengers and it is also in accordance with standard economic literature (Button, 2010). The number of passengers in long-distance routes has positive impact on the number of passengers in the regional transport. Therefore, these goods are complements: passengers transfer between regional trains and long-distance trains.

Based on the results of the model, we consider the price does not have a statistically significant impact on the demand for transport. At first sight, it is surprising. But on the other hand, as we

mentioned before, the price is set by the Ministry of Finance and each region. Therefore, it does not fulfil its functions. In the literature, we can find papers where the price of the transport is inelastic (e.g. Rahman & Balijepalli, 2016) which can be the reason why it is statistically insignificant in our mode. The share of new vehicles as well as the price are not statistically significant. New vehicles cannot reverse the trend of diminishing number of passengers in the regional railway transport.

To sum it up, the number of passengers in the regional railway transport is mostly influenced by external factors which regions cannot change: wages depends on the economic growth, the number of population depends on the demography and migration and the long-distance transport is ordered by the Ministry of Transport as well as the government through the infrastructure manager who is responsible for maintenance of corridors and investments into it. Regions can only influence the supply of the regional transport. Regions seek to optimize timetables to suit passengers' preferences. For these reasons, the rise in supply is very costly.

## 7 CONCLUSION

The regional railway transport has inevitably faced changes. Regions, which are responsible for the regional railway transport, aim to make it more attractive for passengers. Nevertheless, regional railway transport is inferior goods, and higher wages lead to lower demand for transportation. This seems to be unavoidable consequence of the economic growth. The railway was established in 19th century. Many railway lines cannot fulfil ideas of travelling in the 21st century by its geographical situation or speed.

One of the solutions how to promote regional railway transport can be long-distance transport development. The data indicate that high-quality railway corridors can support demand for the regional transport. It should be supported by reasonable timetables, which allow secure transfers. By this is possible only in the part of the railway network, which is close to railway corridors. However, there are lot of regional lines, which are not connected with the railway corridor. These lines cannot gain from growth in the long-distance market. Some of these lines should be removed but this is for another research. Therefore, subsidies from the Structural and Cohesion Funds of the European Union should rather improve railway corridors and easy transfers between the long-distance transport and the regional transport. This can support at least some regional railway lines.

This study is limited by data availability – it contains data from five of fourteen regions. Future study can concentrate on other ways to promote regional railway transport.

### Acknowledgement

This article was supported by the Masaryk University internal grant no. 56/2139 “Nabídková řízení”.

### References

- Act No. 525/1990 Coll. (Zákon Slovenskej národnej rady, ktorým sa mení a doplňa zákon Slovenskej národnej rady č. 126/1985 Zb. o požiarnej ochrane)
- Alexandersson, G., Nash, Ch., & Preston, J. (2008). Risk and reward in rail contracting. *Research in Transportation Economics*, 22(1), 31-35. doi: 10.1016/j.retrec.2008.05.008

- Buehler, R., & Pucher, J. (2011). Making public transport financially sustainable. *Transport Policy*, 18, 126-138. doi: 10.1016/j.tranpol.2010.07.002
- Button, K. J. (2010). *Transport Economics Cheltenham*. UK: Edward Elgar.
- Cipra, T. (2008). *Finanční ekonometrie*. Praha: Ekopress.
- Cowie, J. (2010). *The Economics of Transport: a theoretical and applied perspective*. London: Routledge.
- European Commission. (2011). *Roadmap to a single European transport area: Towards a competitive and resource efficient transport system*. Retrieved from [https://ec.europa.eu/transport/themes/strategies/2011\\_white\\_paper\\_en](https://ec.europa.eu/transport/themes/strategies/2011_white_paper_en)
- Mankiw, N. G. (2009). *Zásady ekonomie*. Praha: Grada.
- Ministry of Transport. (2013). *Dopravní politika ČR pro období 2014 – 2020 s výhledem do roku 2050*. Retrieved from <http://bit.ly/2GksXIO>
- Nash, Ch., Smith, A., Crozet, Y., Link, H., & Nilsson, J. E. (2019). How to liberalise rail passenger services? Lessons from European experience. *Transport Policy*, 79, 11-20. doi: 10.1016/j.tranpol.2019.03.011
- Paulley, N., Balcombe, R., Mackett, R., Titheridge, H., Preston, J., Wardman, M., Shires, J., & White, P. (2006). The Demand for Public Transport: The Effects of Fares, Quality of Service, Income and Car Ownership. *Transport Policy*, 13(4), 295-306. doi: 10.1016/j.tranpol.2005.12.004
- Pohl, J. (2018). *Budoucí požadavky na úlohu železnice a jejich odezva v trendu technologických inovací*. Broumov
- Rahman, S., & Balijepalli, C. (2016). Understanding the determinants of demand for public transport: Evidence from suburban rail operations in five divisions of Indian Railways. *Transport Policy*, 48, 13-22. doi: 10.1016/j.tranpol.2016.02.006.
- Stead, A. D., Wheat, P., Smith, A. S. J., & Cabral, M. O. (2019). Competition for and in the passenger rail market: Comparing open access versus franchised train operators' costs and reliability in Britain. *Journal of Rail Transport Planning & Management*, 12, article 100142. doi: 10.1016/j.jrtpm.2019.100142
- SYDOS. (n.d.). Ročenky dopravy. Retrieved from <https://www.sydos.cz/cs/rocenky.htm>
- Verbeek, M. (2017). *A guide to modern econometrics*. Chichester: Wiley.

## Contact information

### Ondřej Špetík

Masaryk University, Faculty of Economics and Administration  
Lipová 41a, 60200, Brno, Czech Republic  
E-mail: [spetiko@seznam.cz](mailto:spetiko@seznam.cz)  
ORCID: 0000-0002-3953-2261

doi: 10.7441/dokbat.2019.102

# EMPLOYER BRANDING AS THE COMPETITIVE TOOL OF MANAGERS

*Dana Šrámková*

## **Abstract**

The companies of today realise that a strong and competent workforce is an invaluable resource and a great competitive advantage. With the growth of knowledge economy and multinationals it is important that organisations must be prepared and capable to attract a strong and effective workforce. Employer branding represents the company's effort to promote itself both internally and externally to be a different and attractive employer. Recently, employer branding has gained a popularity among executives and top managers. This article presents employer branding from a theoretical perspective, and forms the basic theoretical platform for qualitative research, which has not been implemented on certain issues related to employer branding in the corporate area of the Czech environment.

**Keywords:** *Employer branding, management, talent management, manager, personal marketing*

## **1 INTRODUCTION**

Today's economic situation has completely changed the labour market. Across sectors, the companies must face these changes and use the tools that were not needed. The business environment is changing very quickly and it is needed to react through appropriate tools. The companies around the world face the same business challenges, so it is crucial for them to retain talented employees and maintain long-term sustainability and competitiveness. In addition, the companies are constantly forced to compete for high-quality human resources and making efforts to become a desirable employer for potential employees. The need to attract and retain quality employees remains the key to a successful business. The company differs from the competition by promoting its strengths and corporate values. This ensures the position of the employer that potential employees will choose during the recession and boom. Therefore, many companies focus considerable attention and resources on developing a strong employer brand.

Employer branding is a concept for increasing the value of companies and helps companies to attract new employees, support their engagement and reduce their fluctuation. The employer brand captures the basic philosophy of each company, including answers to questions about why a company exists, what value it produces, what it wants to achieve, how it is managed, what corporate culture it has, and what conditions and bonuses it offers to its employees (Barrow, 2005).

Today's human resources do not consider about one employer for whole life. The new type of workforce redefined employment security to career security. Today's employees (especially the younger generations) require the continuous development of skills and the possibility of permanent education, which the employer is supposed to enable or directly provide. The vast majority of them are already considering whether they will have the opportunity for further develop when they are looking for a new employer. That is why talent management is crucial not only to develop and retain existing employees, but also to attract new workforce.

## **2 THEORETICAL FRAMING**

The practice of employer branding is based on the assumption that human capital brings value to the company and the company can improve its performance through appropriate investments in human capital. The owing of scarce, valuable, irreplaceable and difficult to imitate resources brings to the company a better position than their competitors (Barney, 1991). While the majority still think that production facilities, equipment and capital are considered sources of competitive advantage, human capital has been shown as a leading source that creates a competitive advantage (Priem and Butler, 2001).

Employer branding is also referred to as "a targeted, long-term strategy for managing the awareness and perception of employees, potential employees and stakeholders" (Sullivan, 2004). Employer branding presents the organization as a great place to work (Sullivan, 2004). The use of employer branding as a certain belief and philosophy in a knowledge-based economy has always been seen as a motivating factor due to a lack of skilled workers (Berthon, Ewing and Lian, 2005). Cable and Turban (2001) mention that the company's brand image enhances the quality and quantity of potential job seekers, and also retains existing employees. According to Sullivan (2004), employer branding is a long-term strategy that puts considerable effort into all processes related to the perception of potential employees, and also takes into consideration the expectations of the organization's stakeholders. The employer seeks to involve all employees from top to bottom. So that the organization presents its comprehensive employer brand and reflects reality and business efforts. The term "employer brand" was first used in the second half of the 1990s to highlight the company's reputation and character as an employer in the labour market. Tim Ambler, London Business School senior manager and People in Business chairman Simon Barrow defined the term "employer branding" in the *Journal of Brand Management*. They defined it as "a set of functional, economic and psychological benefits provided by an employer and identifying with the company" (Ambler and Barrow, 1996).

### **2.1 Theoretical basis of employer branding**

The literature from human resources area describes employer branding as a three-step process. First, the company is developing a "value proposition" to be part of the brand. The next step is to use information about corporate culture, management, quality of existing employees and current image of the employer. And the last step is the value of the company in terms of the quality of products and services offered to employees (Barrow, 2005).

The brand value concept provides a complementary theoretical perspective for understanding employer branding. From a marketing point of view, brand value is a set of brand-related assets and commitments that can attribute or reduce the value of a business product or service, or value to a business customer (Aaker, 1991).

Berthon, Ewing and Hah (2005) argue that an attractive employer brand can be considered a certain benefit that a potential employee associates with working for a particular company. The employees with extraordinary skills and knowledge represent a significant competitive advantage in the area of human resources and together with the employer brand create the basic concept of the company. Education, knowledge and skills are becoming crucial. The business success is increasingly determined in Europe by two factors: (1) the right people with (2) appropriate knowledge and skills (Bendaraviciene, Krikstolaitis and Turauskas, 2013; Nagel, 2011). The literature shows that a well-functioning brand leads to a competitive advantage (Backaus and Tikoo, 2004). The companies are increasingly aware of the importance of developing a good employer brand and they are significantly investing in employer-branding campaigns. Through a well-implemented employer branding strategy, the employees typically identify with communicated corporate values. On the other hand, the corporate values are

communicated in an external environment and help to attract potential job seekers (Backhaus and Tikoo, 2004).

The Ipsos research agency (2015), dealing with the issue of employer branding, mentions that when the companies build an employer's brand, it is very important to focus not only on potential employees but also on employees within the company. The employer must understand what motivates them, how they perceive their employer, corporate values and culture. This is the only way to build a trustworthy employer brand that will help not only recruit new employees, but also stimulate their motivation. According to Armstrong and Taylor (2015), the importance of the employer's brand lies in the so-called value offer that the company try to create for its potential and current employees. According to Háša (2016), the work changes over time, so it is not enough just a well-known brand of employer when they create a relationship between employees and the company. Today's employees want meaningful work that is done well by them.

External and internal marketing also play an important role in employer brand building. External marketing helps the company to build an employer position for recruiting of the best possible employees. The brand's distinctiveness enables the company to acquire distinctive human capital. When newcomers are attracted to the brand, a set of preconditions for employment in the company is created, thereby fostering company values and increasing their loyalty to the employer. Internal marketing then helps to meet the needs of employees and thus create a workforce that does not need to go to another employer.

## 2.2 The dimension of employer branding

Barrow (2015) defines twelve dimensions of employer branding, known as the employer brand mix. These dimensions are further divided into two key areas. The first area focuses on the internal context of the company's internal environment. The second concerns the external context and organizational policy.

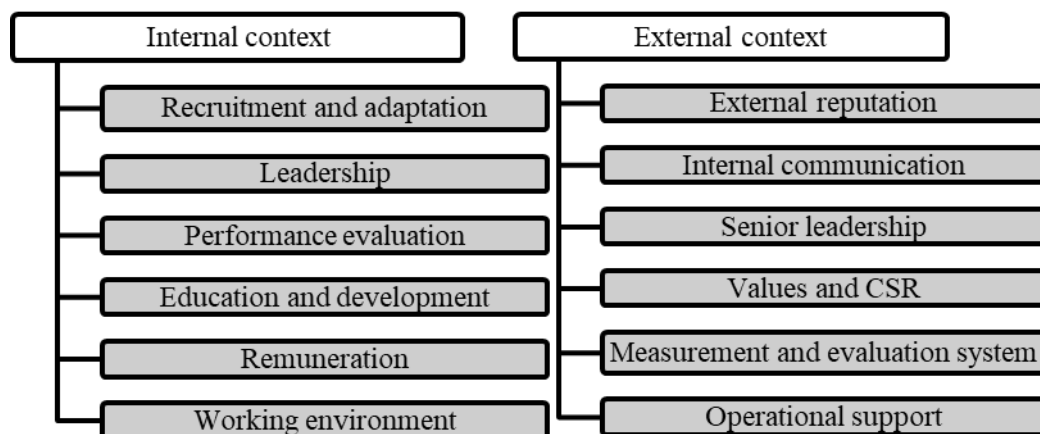

Fig. 1 – Employer brand mix. Source: Barrow (2005)

The internal context of employer branding focuses on the environment and processes in the company. Barrow (2005) defines that the internal context of employer brand building refers to recruitment, adaptation, education, development, remuneration, leadership and appraisal of employees, as well as the work environment related to personnel management. Foster (2010) mentions that within an internal context, a corporate culture and corporate identity should be ensured, reflecting the values and goals that are shared with company employees. The form of the employer's brand must therefore be clearly and unambiguously defined, as it reflects the activities, behaviour and way of communication that differentiate the company from the

competition and create a positive impression on the target groups, so potential and current employees.

The employer's brand policy, which means the external context, is influenced by the quality of the company's products and services, but also by the attitudes and opinions of its current employees. It must be taken account of the company's external reputation when the companies develop a communication strategy (Barrow, 2005) and involve the company's employees in their work, keeping them well informed about important marketing activities, ensuring that they understand the vision, motto and advertising slogans that are disseminated to stakeholders. According to Barrow (2005), "senior leadership" is also an important factor, by which management influences the perception of the brand of employees. The managers should be aware of the impact of their behaviour, because it defines employee engagement with the business. Corporate social responsibility (CSR) is also an important area affecting the employer's brand. A study conducted by the Work Foundation and the Future Foundation shows that 20% of employees consider employers with a positive CSR image more attractive and favour it over others.

### **2.3 Employer brand management**

It is important to mention the difference between employer brand management and employer branding that they are often confused. If we start with the employer branding first, its use is similar to consumer marketing. It is the way of the company how it creates its image through creative expression, communication, social networking, etc. Employer branding is an important part of corporate governance and therefore an important part of employer brand management (Growing people, online, 2018).

One way how to look at brand management is in the same sense as on the corporate brand. It must be ensured that the brand is properly identified and branding is consistent with the key message that the company wants to pass on to the market - to the customer (Growing people, online, 2018).

Employer brand management is described as the coordination of all parts that make up a positive brand. So it is communication, but also the elements of human management. These processes and practices make the brand stronger.

Employer brand management is based on the classic principles of brand management, so the brand building of any products and services. In this case, the company itself becomes of a product that job seekers seek on the labour market. The company should offer the best conditions that it has available against its competitors. The company must be able to sell itself well on the market and be attractive for the potential buyers - "customers". The company tries to benefit maximum from what people think about it, how they feel about it and how they express it. The stories and emotions are an important part of the employer branding process.

Employer brand management includes several components and activities that are currently considered to be the main points in the development of an employer's brand management plan. One of the most important components of EBM is the so-called HR marketing, which is a set of resources and activities that represent the company as an employer to employees and candidates. It includes tools, methodologies and processes that make it possible to build the employer's brand both externally and internally. Another important part is the corporate culture, so everything that creates a quality working environment and supports the performance of employees. The third important part is internal communication. The employees and primary interest groups need to be informed about everything that happens in the company and why they understand their role and job in society. Likewise, the active leadership plays an important role in EBM. True leaders achieve much better results than managers who "only" enforce the

principles of people management. Last but not least, it is also the development of talent that the talented employees and their commitment bring performance to the company and positively influence and inspire others (Growing people, online, 2018).

## **2.4 Employer brand measurement**

It is important for managers to understand how their brand is perceived. This is one of the cornerstones of successful employer branding. So the managers try to understand what people associate with their brand. In addition to these associations, it is necessary to find out if they would prefer their company when they choose an employer. But this is only one side - how the external brand of the employer is perceived. However, there is often no internal perspective. If the employer brand is based on the key priorities defined by the EVP (a set of attributes that the labour market and employees perceive as the value they gain through employment in the company) of the company, the employer brand should also be measured internally to ensure the managers that the promises and the attributes were fulfilled in the eyes of current employees. Inwardly, it is measured how strong the connection with these associations is perceived internally (for example, whether a company is a place to innovate or if it is a place where significant development takes place). Finally, it is necessary to measure the extent as these associations are transformed into engaging employees in the company's operations and employee advocacy.

If something really characterized the strength of the employer's brand, it is employee engagement and advocacy. This is formulated in different ways, but basically it is the defence of the brand by the company's employees. Employee advocacy is a term used to describe the publicity that the employees create for their brand by using their own online resources. Social media is mostly the main tool for employee advocacy. So often the means of employee advocacy are online means such as email, chat, forums, discussion platforms, etc. (Link Humans, online, 2017).

The managers must focus on relevant metrics that can be tracked. These metrics can affect several aspects, from the employer branding's tool to achieving ROI and more. What metrics to track: (a) Return on investment; (b) Employee conversion rate (how many employees participated in advocacy); (c) Employee activity (who are the most active individuals and how often they deal with advocacy); (d) The impact of employee advocacy (how employees' advocacy affects corporate online channels, such as getting new followers); (e) Reach (advocacy for employees enhancing corporate organic reach).

## **2.5 Employer branding and its influence on managers**

Nowadays, the question is why CEOs need to pay more attention to employer brand management. In the study "2020 Outlook: The Future of Employer Branding" (Universum, online, 2018) on current and future trends in employer branding, one of the interesting findings was that the vast majority (73% of respondents) have problem in attracting a suitable talent. The employers consider employers' good reputations as an important aspect of getting the right talent.

In addition to the reputation of the employer, the second area of best management of the employer's brand is the creation of a strong employer brand with transparency and the use of social media with a direct dependence on corporate culture and company values. The executive director himself/herself is the one who should pay attention to the corporate culture and values and take the initiative to take the lead in this area (PwC Study, online, 2018).

Through the systematic confrontation of employees towards to the value issues of employer branding, the culture of the working environment is shaped in line with corporate goals and



enables the company to achieve a unique cultural focus on the way of doing business (Backhouse and Tikoo, 2004).

Employer branding management helps to “sell” the business to job seekers and talented people who could move forward the company's potential. It is also important to retain existing employees, which means minimizing employee fluctuation. This way helps to save the costs for recruitment and adaptation. Employer brand management also helps to systematically build an employer's brand of employer. This employer is then search by talented employees for good reputation. EBM also brings more orders and more profit to the companies. Lastly, employer brand management enables to the managers to create and stabilize processes for the sustainable development and growth.

## **2.6 Employer branding - Talent management tool**

The interest in employer branding is noticeable by the number of articles on the topic of “employer branding”. The world's most widely used Internet search engines Google and Yahoo! recorded over 3,000 records when entering the term “employer branding”. Amber and Barrow (1996) conducted a case study on the usefulness of employer branding, which is based on semi-structured in-depth interviews with respondents from 27 companies about the importance of the brand for human resource management. They concluded that branding has the great importance in the context of employment. A little later, Ewing et al. (2002) point out the increasingly usefulness of employer branding in a knowledge-based economy where there is a shortage of qualified staff with the necessary skills and knowledge.

The practice of employer branding is based on the assumption that human capital brings value to the company. The company can improve its performance through appropriate investments in human capital. The owing to resources that are scarce, valuable, irreplaceable and difficult to imitate, bring the company a better position than to competitors (Barney, 1991).

The attracting and retaining talented employees plays a very important role in personnel policy. The managers are increasingly interested in human resources development, mainly because of incoming generations of Y and Z generation employees. These categories of people have a completely different approach to work than previous generations (comparison in X, Y and Z generation behaviour is shown in the table below).

Today's human resources already don't think about one employer for life. Today's employees (especially the younger generations) require the continuous development of skills and the possibility of permanent education, which the employer is supposed to enable or directly provide.

Talent Identification, Management & Evaluation, or TIME in short, is an approach that can be applied to the development of talented employees. Human resources development is one of the priority areas of human resources policy of companies, which enables their sustainable growth.

The first step towards a successful implementation of the talent development strategy is to identify the talented people. The selection criteria can be varied, but the motivation and commitment of nominated candidates is essential. In the next step, it is needed to attract the talented people with by a development plan.

The talented individuals can be defined as someone who has the potential for high work performance, contributing to increasing the competitiveness of the company and promoting the corporate culture in the right direction.

Tab. 1 – Generational differences in the Czech Republic. Source: LMC (2017)

<b>GENERATION X</b> <b>1965 – 1980</b> <i>"Don't trust anyone over 30 years. After thirty, you have to change the world for the better."</i>	<b>GENERATION Y</b> <b>1981 – 1995</b> <i>"Why am I here? What is the meaning of my life? Where's my phone? "</i>	<b>GENERATION Z</b> <b>1996 – now</b> <i>"Clicking or tapping the screen, I am."</i>
Baby boomers, post-war generation	The most common question is WHY?	Simple individualists, impatient, self-centred
They respect the traditional values but have their own attitudes	They require a work-life balance	Their priority is education and developing their skills
They value the work, they can give the company a lot	They want their work to make sense	They are obsessed with experience, they want to touch everything and try everything
They are willing to work 10-12 hours a day and work at the weekends	They want freedom, travel, getting to know other states and people	They mature quite quickly, with resistance to traditional society
Important for them are success, career, family, reputation	They want to work from home, refuse a time consuming job	Important for them are freedom, certain elusiveness, travel
It is important to have a value system for them	They want responsibility, they want to participate	They want to be financially independent
	They want to change	

The main benefits for management and employers are primarily the minimization of losses, which is associated with the vacancy of key positions (especially senior positions). It is also a reduction in fluctuation costs associated with recruiting (Growing People, Online, 2018).

Due to low differentiation, employers try to identify themselves against their competitors using a unique corporate culture and corporate identity. If employees feel belonging to the organization and its values, they become loyal to both the employer and its brand. This increases their productivity and quality of work. The image of the employer is formed on the basis of associations. In case of a positive image, the employer becomes attractive and desirable for potential employees (Backhaus and Tikoo, 2004).

## **2.7 The current research in the field of employer branding**

Recently, the company Universum (online, 2018) surveyed over 2,000 HR professionals and CEOs around the world to find out about their talent recruitment and employer branding experience.

The survey concludes that executive directors consider themselves to be the main employer branding actors, with 60% (32% HR). If we look at the same thing from the HR perspective, then these professionals consider themselves responsible for employer branding in 58% (CEOs 26%). 61% of the organizations say that they have defined Employer Value Proposition (EVP), but EVP is not covered in all areas and the instruments are not properly identified. This means that existing EVP is not properly circulated in the internal environment of company.

Another important indicator are social media. Social media is generally regarded by managers as the most important digital channel for employer branding, at 35%. A very important communication channel is also the employer's website (29%). Here it is important to link the site to the HR area (either by a separate section or by linking to a separate career site - specific recruitment site). The job servers are also important (12%), paid advertising by employers on

social networks (9%) and targeted messages via e-mail notifications (7%). The experts are expected that the using of social media will increase from 35% to 70% over the next five years.

The last important aspect is the relationship - the unification of the consumer brand with the employer's brand. Only 36% of respondents said that brands are unifying at present. More than half (52%) of companies say that within five years their company will unify the consumer and employer brands (Universum, 2018).

### **3 SUGGESTED RESEARCH DESIGN AND METHOD**

Based on the theoretical background, the qualitative research should be carried out. The qualitative research is a method that can answer questions about employer branding in the Czech environment. Currently, no research has been carried out that would correspond to individual areas of employer branding in the Czech environment.

Although the importance of qualitative research is increasing, its definition is difficult. It is a broad indication of very different approaches (Kozel et al, 2011). Creswell (2009) calls qualitative research a process of seeking understanding, which is based on various methodological traditions of exploring the problem. Hendl (2005) characterizes qualitative research as a tool for obtaining an integrated view of the subject matter, its context logic, explicit and implicit rules of its operation.

The reason for qualitative research is the lack of information about employer branding in practice and about the perception of employer branding by business practice in the Czech environment. The aim of the qualitative research will be to create a comprehensive picture of the real use of employer branding in business practice (Molnár et al, 2012) and to reveal the associations with this topic in the target group (human resources experts in business practice), especially in connection with recruitment and with the stabilization of existing employees (Tahal et al, 2017).

The representatives of selected companies will participate in the research. In order to maximize the success of the expert interviews and to ensure the heterogeneity of responses, the respondents will be the representatives of companies from the different companies according to the applied corporate culture.

The aim of the qualitative research should be to determine the perception of employer branding by business practice, to identify variables related to employer branding and its practical use. Important is also to determine the means used in practice for stabilizing of existing employees and the means used to recruit new employees.

The expert interviews will be conducted with managers, specialists in the field of human resources in selected companies. The answers will be analysed and synthesized. The result of qualitative research will be a comprehensive picture of the real use of employer branding in business practice. This research will fill the information gap.

### **4 DISCUSSION AND CONCLUSIONS**

Employer branding is a relatively new approach to recruiting and gains the best possible human talent in an increasingly competitive human capital environment. Employer branding has the potential to be a valuable concept for managers and scientists. The managers can use employer branding as an overarching concept by which they can recruit high-quality employees for their company and thus fulfil the established human resources strategy.

Today, there is no doubt that employer branding is a necessary competitive advantage that attracts and maintains a competitive workforce. This advantage then helps the company to expand and grow. Last but not least, it also ensures that the best employees remain loyal to the company and make greater efforts to meet the goals of the organization.

At present, here is a lack of comprehensive information on the use of employer branding in the business sector in the Czech Republic. For this purpose, it is necessary to conduct qualitative research focused on HR specialists and managers who are in the corporate environment. The answers of experts can provide important outputs useful for businesses in the Czech Republic.

## References

- Aaker, A. D. (1991). *Managing Brand Equity: Capitalizing on the Value of a Brand Name*. New York: Free Press.
- Ambler T. & Barrow, S. (1996). The employer brand. *The Journal of Brand Management*, 4(3), 185-206. doi: 10.1057/bm.1996.42
- Armstrong, M. & Taylor, S. (2015). *Řízení lidských zdrojů: Moderní pojetí a postupy*. Praha: Grada.
- Asociace studentů a absolventů. (2018). *Top zaměstnavatel*. Výzkumná zpráva, Praha.
- Backhaus K. & Tikoo, S. (2004). Conceptualizing and researching employer branding. *Career Development International*, 9(5), 501-517. doi: 10.1108/13620430410550754
- Barney, J. B. (1991). Firm resources and sustained competitive advantage. *Journal of Management*, 17(1), 99-120. doi: 10.1177/014920639101700108
- Barrow, S. & Mosley, R. (2005). *The Employer Brand: Bringing the Best of Brand Management to People at Work*. Chichester: John Wiley & Sons.
- Bednař, V. (2013). *Sociální vztahy v organizaci a jejich management*. Praha: Grada.
- Berthon, P., Ewing, M. & Lian, H. L. (2005). Captivating company: dimensions of attractiveness in employer branding. *International Journal of Advertising*, 24(2), 151-172. doi: 10.1080/02650487.2005.11072912
- Cable, D. M. & Turban, D. B. (2001). Establishing the dimensions, sources and value of job. *Research in Personnel and Human Resource Management*, 20(1), 115-163. doi: 10.1016/S0742-7301(01)20002-4
- Ewing, M. T., Pitt, L. F., de Bussy, N. M., & Berthon, P. (2002). Employment branding in the knowledge economy. *International Journal of Advertising*, 21(1), 3-22. doi: 10.1080/02650487.2002.11104914
- Foster, C., Punjaisri, K. & Cheng, R. (2010). Exploring the relationship between corporate, internal and employer branding. *Journal of Product & Brand Management*, 19(6), 401-409. doi: 10.1108/10610421011085712
- Growing people. (2018) *EBM Employer Brand Management*. Retrieved from <http://www.growingpeople.cz/nase-produkty/employer-brand-management/>
- Háša, S. (2016). *Co je nového v managementu*. Praha: Nová beseda.
- Ipsos. (2015). *Employer Brand přitahuje pozornost stále více firem*. Praha: Ipsos. Retrieved from <http://www.ipsos.cz/employer-brand-pritahuje-pozornost-stale-vice-firem/>
- Johnson, G. & Scholes, K. (2000). *Cesty k úspěšnému podniku*. Praha: Computer Press.

- Link humans. (2018). *A Kickstart Guide to Employee Advocacy on Social Media*. Retrieved from <https://linkhumans.com/employee-advocacy-guide/>
- LMC. (2018). *6 triků, jak psát inzeráty, na které uchazeči odpovídají*. Retrieved from <https://www.lmc.eu/cs/6-triku-psat-inzeraty-ktere-uchazeci-odpovidaji/>
- Molnár, Z. (2006). *Úvod do základů vědecké práce*. Retrieved from [http://kit.vse.cz/kit/WCMS\\_KIT.nsf/pages/ZakladyVedeckePrace.html](http://kit.vse.cz/kit/WCMS_KIT.nsf/pages/ZakladyVedeckePrace.html)
- Nagel, K. (2011). *Employer Branding. Starke Arbeitgebermarken jenseits von Marketingphrasen un Werbetechniken. Wirtschafts Woche*. Retrieved from [http://195.20.235.5/files/dr.\\_katja\\_nagel\\_employer\\_branding\\_case\\_compeople\\_2.pdf](http://195.20.235.5/files/dr._katja_nagel_employer_branding_case_compeople_2.pdf)
- Priem, R. L. & Butler, J. E. (2001). Is the resource based view a useful perspective for strategic management research? *The Academy of Management Review*, 26(1), 22-40. doi: 10.5465/amr.2001.4011928
- Pstružina, K. (2002). *Atlas filosofie vědy*. Praha: Vysoká škola ekonomická. Retrieved from <http://nb.vse.cz/kfil/Win/atlas1/atlas3.htm>
- PWC. (2018). *The Anxious Optimist in the Corner Office*. Retrieved from <https://www.pwc.com/gx/en/ceo-agenda/ceosurvey/2018/cz>
- Sullivan, J. (2004). *Eight elements of a successful employment brand*. Retrieved from [www.ereexchange.com/articles/db/52CB45FDADFAA4CD2BBC366659](http://www.ereexchange.com/articles/db/52CB45FDADFAA4CD2BBC366659)
- Sullivan, J. (2016). *The 2nd Biggest Mistake in Employer Branding - Failing to Measure Employer Brand Strength*. Retrieved from <http://www.ere-media.com/ere/the-2nd-biggest-mistake-in-employer-branding-failing-to-measure-employer-brand-strength>
- Sundberg, J. A. (2018). *Guide to Employer Brand Management*. Retrieved from <https://linkhumans.com/employer-brand-management-richard-mosley/>
- Universum. (2018). *The Future of Employer Branding*. Retrieved from <https://theundercoverrecruiter.com/future-employer-branding>

## Contact information

**Ing. Dana Šrámková**

Czech University of Life Sciences Prague, Faculty of Economics and Management

Kamýcká 129, 16521 Prague 6, Czech Republic

E-mail: [danasramkova@yahoo.com](mailto:danasramkova@yahoo.com)

ORCID: 0000-0003-1498-8884

doi: 10.7441/dokbat.2019.103

# DETERMINATION OF REAL ESTATE MARKET PRICES USING ARTIFICIAL NEURAL NETWORKS

*Michaela Štubňová, Marta Urbaníková*

## **Abstract**

The actual market price of real estate is needed by individuals, legal entities and, in particular, institutions in the sale and transfer of real estate. Determining the right market price of real estate is also equally important for property settlement, inheritance proceedings, bailiff proceedings, investment projects, and loans secured by real estate. Various methods are used to determine this, such as the comparative method, the profits method, the contractor's/cost method, and the regression models. Currently, researchers are paying close attention to automated methods of real estate appraisal using soft computing methods – fuzzy logic, artificial neural networks, and genetic algorithms. This study aims to analyse the application of artificial neural networks for determining the real estate market price. We have analysed artificial neural networks trained with the Levenberg-Marquart learning algorithm, the Bayesian Regularization learning algorithm, and the Scaled Conjugate Gradient learning algorithm. By comparing the results of all developed and validated networks, we found that networks trained by the Bayesian Regularization learning algorithm achieved the best performance. Based on the results of the study, we recommend the use of artificial neural networks with the Bayesian Regularization learning algorithm for automated property appraisal. The application of these methods is possible for banks, real estate agencies, notary offices, bailiff offices, and for legal entities and institutions providing an expert appraisal of real estate.

**Keywords:** *real estate market price, property appraisal, artificial neural network, learning algorithm*

## **1 INTRODUCTION**

In determining market prices of real estate, legal persons and institutions may use traditional methods or advanced appraisal methods. Pagourtzi et al. (2003) rank the comparative method, the profits method, the contractor's/cost method, and the regression models among the traditional methods. By the comparative method, the price is determined by comparison with selling prices of recently sold similar properties in the same market location. However, this is only possible in areas with a developed real estate market. The profit method for determining the market price of a property can be applied to a property that generates revenue and the market value of the property is determined by the potential cash flow from the property ownership. The contractor's/cost method is based on the principle of determining how much it would cost at the time of sale to construct a property similar to that valued, taking into account its obsolescence and depreciation. The method is based on the assumption that the buyer will not pay more for the property than he would pay for the construction of a new building relative to the existing one. The Regression models are referred to as hedonic pricing models by Des Rosiers (2012), Thanasi (2016), and Yeh & Hsu (2018). It represents a quantitative method of the comparable approach. “The methodology of hedonic prices allows us to estimate the value contributed by each of the attributes (physical or otherwise) to a property, and to make predictions about the behaviour of the rest of the properties when any of these elements vary” (Moreno-Izquierdo et al., 2018).

In recent decades, soft computing methods have been developed with applications in a wide range of sectors such as computer engineering, industry, economics, financial markets, medicine and more. They have also found their application in real estate appraisal. Thanks to them, real estate agencies, banks and mortgage institutions are able to perform property pricing automatically and with high accuracy. This maximizes profit when selling real estate, and reduces the risk of losses from loan defaults on loans secured by real estate. Park & Bae (2015) conducted an analysis of 4 machine learning algorithms for housing price prediction - C4.5, RIPPER (Repeated Incremental Pruning to Produce Error Reduction), Naïve Bayesian, and AdaBoost (Adaptive Boosting). The machine learning algorithms were applied to a data set including real estate data, public school ratings, and mortgage rate data. Comparison of another 4 machine learning algorithms - Support vector regression, k-nearest neighbours, Ensembles of regression trees, and Multi-layer perceptron was conducted by Baldominos et al. (2018). Performance of artificial neural network (ANN) and hedonic regression model for the price optimization procedure was compared by Moreno-Izquierdo et al. (2018). They determined the rental price of Airbnb real estate. They reported that ANN achieved considerable improvement in price accuracy. Georgiadis (2018) analysed performance of spatial auto-regressive (SAR) model, geographically weighted regression (GWR), multiple linear regression (MLR) and ANN in real estate price determination. Slightly higher accuracy was reported for the GWR model compared to ANN. Tabales, Carmona & Ocerin (2013), Kutasi & Badics (2016), and Abidoye & Chan (2018) conducted a comparison of accuracy of real estate appraisal using ANN and multiple regression analysis (MRA) representing hedonic pricing model. Reported results show ANN's ability to achieve higher accuracy in determining prices. Chiarazzo et al. (2014) reported that the environmental quality of property location was an important attribute in real estate appraisal using ANN. Research has shown that ANN is a suitable method for determining market prices of real estate. In this study, we deal with a selection of suitable learning algorithm of ANN. We analysed ANN trained using the Levenberg-Marquart (LM) learning algorithm, the Bayesian Regularization (BR) learning algorithm, and the Scaled Conjugate Gradient (SCG) learning algorithm.

## **2 ARTIFICIAL NEURAL NETWORKS**

Soft Computing methods, including ANN, are able to process data with imprecisions, uncertainties, and approximations. Using complex algorithms, they can solve complex problems that are difficult to accurately describe by mathematical models (Ibrahim, 2016). Inspiration for ANN comes from the human brain. An important similarity is in the ability of ANN to learn and thereby improve its performance. The basic building unit of the network is a simplified model of a biological neuron. Neurons process the information with an activation function. To transmit the information, the individual neurons are connected by oriented weighted connections and are organized into layers. Figure 1 shows a multilayer neural network architecture. There are three types of layers – input layer, hidden layer, and output layer. They differ in the sources of their inputs and in the use of their outputs. The input layer processes the data of the independent variables that are inputs to the ANN and transmits it to the next network layer. Hidden layers process outputs from previous layers and transmit them to the next layer. The output layer processes the outputs of the previous hidden layer and gives the value of the dependent variable as an output (Parot, Michell & Kristjanpoller, 2019, Yildirim, 2019). The ANN shown in Figure 1 is the feedforward neural network, the signal proceeds through directed connections in one direction – forward.

ANN learns and stores acquired knowledge by adjusting the connection's weight values and neuron threshold values ( $\theta$ ). When training neural networks, several learning rules can be used.

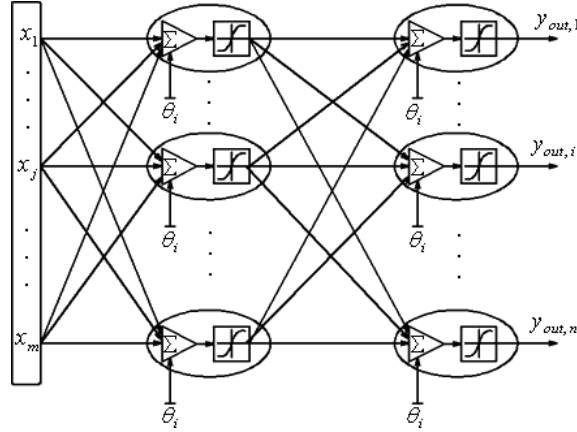

Fig. 1 – Architecture of the multilayer neural network. Source: own research

In this study, we compared performance of the LM learning algorithm, the BR learning algorithm, and the SCG learning algorithm. These are variations on the Backpropagation algorithm. Li, Cheng, Shi & Huang (2012) described the Backpropagation algorithm in two steps. In the first step is the operating signal propagated forward through the network layers. The difference between the real and the expected output is the error signal. In the second step, the error signal is backpropagated through the network, during this backpropagation the weight values and threshold values are adjusted. The gradient descent method is used to minimize the error signal and therefore optimize the network performance.

## 2.1 Levenberg-Marquart learning algorithm

The LM learning algorithm is a combination of the gradient descent method and the Gauss-Newton method. It minimizes a non-linear function with a numerical solution (Gavin, 2019). According to Yu & Wilamowski (2011), the learning rule of LM algorithm is given by:

$$w_{k+1} = w_k - (\mathbf{J}_k^T \mathbf{J}_k + \mu \mathbf{I})^{-1} \mathbf{J}_k \mathbf{e}_k \quad (1)$$

where  $w_{k+1}$  and  $w_k$  are components of weight vector  $\mathbf{w}$ ;  $\mu$  is a combination coefficient with positive value;  $\mathbf{I}$  is the identity matrix;  $\mathbf{e}_k$  is a vector of training errors defined as  $\mathbf{e}_k = y_k - \widehat{y}_k$ , where  $y_k$  are target values and  $\widehat{y}_k$  are output values;  $\mathbf{J}$  is the Jacobian matrix defined as:

$$\mathbf{J} = \begin{bmatrix} \frac{\partial e_{1,1}}{\partial w_1} & \frac{\partial e_{1,1}}{\partial w_2} & \dots & \frac{\partial e_{1,1}}{\partial w_N} \\ \frac{\partial e_{1,2}}{\partial w_1} & \frac{\partial e_{1,2}}{\partial w_2} & \dots & \frac{\partial e_{1,2}}{\partial w_N} \\ \vdots & \vdots & \vdots & \vdots \\ \frac{\partial e_{1,M}}{\partial w_1} & \frac{\partial e_{1,M}}{\partial w_2} & \dots & \frac{\partial e_{1,M}}{\partial w_N} \\ \vdots & \vdots & \vdots & \vdots \\ \frac{\partial e_{P,1}}{\partial w_1} & \frac{\partial e_{P,1}}{\partial w_2} & \dots & \frac{\partial e_{P,1}}{\partial w_N} \\ \frac{\partial e_{P,2}}{\partial w_1} & \frac{\partial e_{P,2}}{\partial w_2} & \dots & \frac{\partial e_{P,2}}{\partial w_N} \\ \vdots & \vdots & \vdots & \vdots \\ \frac{\partial e_{P,M}}{\partial w_1} & \frac{\partial e_{P,M}}{\partial w_2} & \dots & \frac{\partial e_{P,M}}{\partial w_N} \end{bmatrix} \quad (2)$$

where  $N$  is a number of weights,  $M$  is a number of outputs and  $P$  is a number of patterns.



## 2.2 Bayesian Regularization learning algorithm

The RB adds an additional term to a commonly used performance function (3). By adding this additional term, performance function (4) is able to penalize weights to improve network generalization ability. Parameters of performance functions are optimized according to LM algorithm.

$$F = E_d = \frac{1}{n} \sum_{i=1}^n (e_i)^2 \quad (3)$$

$$F = \beta E_d + \alpha E_w \quad (4)$$

where  $\alpha$  and  $\beta$  are parameters to optimize,  $E_w$  is the sum of squares of network weights,  $n$  is the number of data points,  $e_i = y_i - \hat{y}_i$ , where  $y_i$  are target values,  $\hat{y}_i$  are output values (Doan & Liong, 2004, Kayri, 2016, Yucesan, Gul & Celik, 2017).

## 2.3 Scaled Conjugate Gradient learning algorithm

The SCG learning algorithm is based on conjugate gradient method, which is suitable for large-scale problems. The step size scaling method is used in order to avoid line-search at each iteration, which makes the training process time-consuming. The calculations used in the algorithm are described in detail by Møller (1993).

## 3 METHODOLOGY AND DATA

The data were obtained from the internet real estate portal TopReality in the period from 9.9.2019 to 13.9.2019 (TopReality, 2019). The search criteria for published properties were: property type = apartment, locations = city of Nitra, bid category = sale. Based on these criteria, 711 properties were selected from which we excluded mislabelled properties that did not meet some of the criteria, duplicate properties, and properties that did not include all monitored parameters. After selection, we obtained 256 properties. The monitored property parameters are listed in Table 1.

Tab. 1 – Property parameters. Source: own research

Parameter	Type	Values
Price	quantitative	real number
Location	qualitative	Old Town, Chrenová, Klokočina, Diely, Čermáň, Zobor
Number of rooms	quantitative	integer
Living area [m <sup>2</sup> ]	quantitative	real number
Floor	qualitative	ground floor, middle floor, upper floor
Number of storeys	qualitative	1 to 4 storeys building, 5 or more storeys building
Elevator	qualitative	yes, no
Balcony	qualitative	yes, no
Cellar	qualitative	yes, no
Apartment condition	qualitative	new building, complete reconstruction, partial reconstruction, original condition
Storage room	qualitative	yes, no
Insulated building	qualitative	yes, no
Parking place	qualitative	yes, no, can be purchased

Descriptive statistics for quantitative variables are shown in Table 2.

Tab. 2 – Descriptive statistics for quantitative variables. Source: own research

Variable	Min	Max	Average	Median	Transformation
Price	47000	219000	101471.5	97800	log
Number of rooms	0	4	2.519531	3	square root
Living area [m <sup>2</sup> ]	19	134	67.95703	67	log

Categorical parameters were converted to dummy variables and their descriptive statistics are shown in Table 3.

Tab. 3 – Descriptive statistics for qualitative variables. Source: own research

Variable		N	%	Variable	N	%	
Location	Old Town	73	28.52%	Balcony	180	70.31%	
	Chrenová	58	22.66%	Cellar	183	71.48%	
	Klokočina	80	31.25%	Apartment condition	new building	21	8.20%
	Diely	25	9.77%		complete reconstruction	106	41.41%
	Čermán	15	5.86%		partial reconstruction	92	35.94%
	Zobor	5	1.95%		original condition	37	14.45%
Floor	ground floor	26	10.16%	Storage room	64	25.00%	
	middle floor	182	71.09%	Insulated building	yes	22	8.59%
	upper floor	48	18.75%		no	227	88.67%
Number of storeys	1 to 4 storeys building	73	28.52%	Parking place	can be purchased	7	2.73%
	5 or more storeys building	183	71.48%				
Elevator		190	74.22%				

The study compared performance of ANNs train with the LM learning algorithm, the BR learning algorithm, and the SCG learning algorithm. For networks trained by the LM and the SCG learning algorithms, the data was divided into a training, validation, and test set in a ratio of 70:15:15. For networks trained by the BR learning algorithm, the data was divided into a training and test set at a ratio of 85:15.

The determination coefficient ( $R^2$ ), root mean square error ( $RMSE$ ), mean absolute error ( $MAE$ ) and the mean absolute percentage error ( $MAPE$ ) were used to evaluate network performance.

$$R^2 = 1 - \frac{\sum_{i=1}^n (y_i - \hat{y}_i)^2}{\sum_{i=1}^n (y_i - \bar{y})^2} \quad (5)$$

$$RMSE = \sqrt{\frac{\sum_{i=1}^n (y_i - \hat{y}_i)^2}{n}} \quad (6)$$

$$MAE = \frac{1}{n} \sum_{i=1}^n |y_i - \hat{y}_i| \quad (7)$$

$$MAPE = \frac{100}{n} \sum_{i=1}^n \left| \frac{y_i - \hat{y}_i}{y_i} \right| \quad (8)$$

where  $\bar{y}$  is the mean of target values.

## 4 RESULTS AND DISCUSSIONS

For each of the training algorithms were developed and validated twenty neural networks, four networks with one hidden layer and sixteen networks with two hidden layers. As the number of neuron in hidden layers were used values 5, 10, 15 and 20. Table 4 shows the performance index values for developed networks.

Tab. 4 – ANN results. Source: own research

LA	Neurons in hidden layers	$R^2$	<i>RMSE</i>	<i>MAE</i>	<i>MAPE</i>	LA	Neurons in hidden layers	$R^2$	<i>RMSE</i>	<i>MAE</i>	<i>MAPE</i>
LM	5	0.8523	13745.36	9229.91	9.12%	BR	10-15	0.9565	7665.47	4258.816	4.12%
LM	10	0.9088	11265.86	8267.742	7.97%	<b>BR</b>	<b>10-20</b>	<b>0.9749</b>	<b>6241.133</b>	<b>3561.288</b>	<b>3.39%</b>
LM	15	0.8569	13656.69	10042.9	10.14%	BR	15-5	0.9659	7288.694	4438.745	4.23%
LM	20	0.9280	9986.784	7072.367	6.79%	BR	15-10	0.9717	6787.509	3828.695	3.61%
LM	5-5	0.9350	9947.733	6521.659	6.14%	<b>BR</b>	<b>15-15</b>	<b>0.9704</b>	<b>6220.818</b>	<b>3665.597</b>	<b>3.58%</b>
LM	5-10	0.9007	13077.79	6004.726	5.96%	BR	15-20	0.9611	6820.316	3874.413	3.82%
LM	5-15	0.9061	11852.41	8552.182	8.32%	BR	20-5	0.9625	7338.346	4187.562	4.06%
LM	5-20	0.9091	12079.9	7296.345	6.89%	BR	20-10	0.9662	6772.23	3880.749	3.77%
LM	10-5	0.9405	9602.311	5771.379	5.36%	BR	20-15	0.9682	6679.491	3883.853	3.70%
LM	10-10	0.8766	13220.69	9996.175	9.74%	BR	20-20	0.9698	6430.204	3907.173	3.77%
LM	10-15	0.8601	13794.88	10222.35	9.75%	SCG	5	0.9271	10184.15	7561.64	7.21%
LM	10-20	0.8495	14062.58	10581.11	10.76%	SCG	10	0.9006	11715.4	8334.081	8.04%
LM	15-5	0.9240	10514.22	6368.246	6.04%	SCG	15	0.9261	10376.74	7524.461	7.16%
LM	15-10	0.9313	9760.708	6231.735	5.98%	SCG	20	0.9315	10079.08	7135.164	6.78%
LM	15-15	0.8921	13368.44	8797.231	8.09%	SCG	5-5	0.9128	11441.32	8021.374	7.57%
LM	15-20	0.9436	8141.192	4861.49	4.86%	SCG	5-10	0.8789	13109.92	9387.637	8.98%
LM	20-5	0.7929	15697.29	10792.77	10.85%	SCG	5-15	0.8271	13980.86	10269.23	10.52%
LM	20-10	0.9100	11288.59	8101.088	7.70%	SCG	5-20	0.8353	15271.5	10867.49	10.41%
LM	20-15	0.9058	11505.33	7786.672	7.34%	SCG	10-5	0.8815	13278.19	9130.59	8.73%
LM	20-20	0.9004	11826.02	6537.475	6.25%	SCG	10-10	0.8100	15490.71	10879.82	10.96%
BR	5	0.9645	7144.242	4967.471	4.71%	SCG	10-15	0.9122	11162.33	7943.861	7.62%
BR	10	0.9611	7310.772	4738.433	4.51%	SCG	10-20	0.8718	13577.7	9912.593	9.56%
BR	15	0.9714	6348.136	4237.133	4.06%	SCG	15-5	0.8617	13581.81	9932.115	9.67%
BR	20	0.9726	6470.599	4119.071	3.87%	SCG	15-10	0.8329	15524.72	10890.15	10.48%
BR	5-5	0.9611	7131.095	4534.865	4.44%	SCG	15-15	0.9145	11523.76	6992.553	6.64%
BR	5-10	0.9565	8507.632	5139.526	4.86%	SCG	15-20	0.9214	10620.23	7447.036	7.03%
BR	5-15	0.9666	6916.356	4713.782	4.54%	SCG	20-5	0.8298	14104.13	10489.44	10.62%
BR	5-20	0.9583	7749.986	4910.104	4.73%	SCG	20-10	0.9418	8887.844	6364.894	6.20%
BR	10-5	0.9736	6270.685	3751.341	3.51%	SCG	20-15	0.9056	11414.08	7951.508	7.68%
BR	10-10	0.9658	6865.62	3775.612	3.71%	SCG	20-20	0.9003	11293.47	8182.298	8.02%

The best values of  $R^2$ , *MAE* and *MAPE* was achieved by network trained with BR learning algorithm and had two hidden layers, first with 10 neurons and second with 20 neurons. The lowest value of *RMSE* was achieved by network trained with the BR algorithm and with 15 neurons in both hidden layers. The difference is due to the higher sensitivity of *RMSE* to larger

deviations. From Table 4 is clear that networks trained with the BR algorithm achieved significantly better results.

BR algorithm was able to approximate the price function well, despite a smaller data set containing 256 observations. The ability to merge training and validation data sets into a training set is an advantage of the BR algorithm for small data sets. Based on previous research and the results of our work, we recommend using ANN with the BR learning algorithm and two hidden layers to determine the real estate market price.

## 5 CONCLUSIONS

Determining the real estate market price is an important part of the activities of real estate agencies, notary and bailiff offices, banks and financial institutions providing loans secured by real estate. Accuracy is important when choosing a suitable property appraisal model. Previous studies have shown that ANN achieves a higher degree of accuracy compared to hedonic regression models. Based on the results of a comparison of networks trained using the LM learning algorithm, BR learning algorithm, and SCG learning algorithm, we can conclude that BR based networks achieve the best performance. Networks trained with this algorithm have determined the price of real estate with accuracy from 3.39% to 4.86%, depending on the number of hidden layers and the number of neurons. We recommend banks, real estate agencies and other property appreciation institutions to use ANN trained with the BR learning algorithm to determine real estate prices in practice.

### Acknowledgment

This paper was supported by the University Grant Agency of Constantine the Philosopher University in Nitra UGA no. VII/16/2019.

### References

- Abido, R. B., & Chan, A. P. C. (2018). Improving property valuation accuracy: a comparison of hedonic pricing model and artificial neural network. *Pacific Rim Property Research Journal*, 24(1), 71-83, doi: 10.1080/14445921.2018.1436306
- Baldominos, A., Blanco, I., Moreno, I. J., Iturrarte, R., Bernárdez, O., & Afonso, C. (2018). Identifying Real Estate Opportunities Using Machine Learning. *Applied Sciences*, 8(11), 1-23. doi: 10.3390/app8112321
- Chiarazzo, V., Caggiani, L., Marinelli, M., & Ottomanelli, M. (2014). A Neural Network based model for real estate price estimation considering environmental quality of property location. *Transportation Research Procedia*, 3, 810-817. doi: 10.1016/j.trpro.2014.10.067
- Des Rosiers, F. (2012). Market Efficiency, Uncertainty And Risk Management in Real Estate Valuation - How Hedonics May Help. *Aestimum*, 511-533. doi: 10.13128/Aestimum-13159
- Doan, C., & Liang, S. (2004). *Generalization for multilayer neural network Bayesian regularization or early stopping*. Retrieved from [https://www.researchgate.net/publication/240713951\\_Generalization\\_for\\_multilayer\\_neural\\_network\\_bayesian\\_regularization\\_or\\_early\\_stopping](https://www.researchgate.net/publication/240713951_Generalization_for_multilayer_neural_network_bayesian_regularization_or_early_stopping)

- Gavin, H. P. (2019). *The Levenberg-Marquardt algorithm for nonlinear least squares curve-fitting problems*. Durham: Duke University. Retrieved from <http://people.duke.edu/~hpgavin/ce281/lm.pdf>
- Georgiadis, A. (2018). Real estate valuation using regression models and artificial neural networks: An applied study in Thessaloniki. *RELAND: International Journal of Real Estate & Land Planning*, 1, 292-303. Retrieved from <http://ejournals.lib.auth.gr/reland/article/view/6485/6228>
- Ibrahim, D. (2016). An overview of soft computing. *Procedia Computer Science*, 102, 34-38. doi: 10.1016/j.procs.2016.09.366
- Kayri, M. (2016). Predictive Abilities of Bayesian Regularization and Levenberg–Marquardt Algorithms in Artificial Neural Networks: A Comparative Empirical Study on Social Data. *Mathematical and Computational Applications*, 21(20), 1-11. doi: 10.3390/mca21020020.
- Kutasi, D., & Badics, M. C. (2016). Valuation methods for the housing market: Evidence from Budapest. *Acta Oeconomica*, 66(3), 527-546. doi: 10.1556/032.2016.66.3.8
- Li, J., Cheng, J., Shi, J. & Huang, F. (2012). Brief Introduction of Back Propagation (BP) Neural Network Algorithm and Its Improvement. In D. Jin & S. Lin (Eds), *Advances in Computer Science and Information Engineering: Advances in Intelligent and Soft Computing*. Berlin: Springer. doi: 10.1007/978-3-642-30223-7\_87
- Møller, M. F. (1993). A scaled conjugate gradient algorithm for fast supervised learning. *Neural Networks*, 6(4), 525-533. doi: 10.1016/S0893-6080(05)80056-5
- Moreno-Izquierdo, L., Egorova, G., Pereto-Rovira, A., & Mas-Ferrando, A. (2018). Exploring the use of artificial intelligence in price maximisation in the tourism sector: its application in the case of Airbnb in the Valencian Community. *Investigaciones regionales: Journal of Regional Research*, 42, 113-128. Retrieved from <http://hdl.handle.net/10017/37170>
- Pagourtzi, E., Assimakopoulos, V., Hatzichristos, T., & French, N. (2003). Real estate appraisal: A review of valuation methods. *Journal of Property Investment & Finance*, 21(4), 383-401. doi: 10.1108/14635780310483656
- Park, B., & Bae, J. K. (2015). Using machine learning algorithms for housing price prediction: The case of Fairfax County, Virginia housing data. *Expert Systems with Applications*, 42(6), 2928-2934. doi: 10.1016/j.eswa.2014.11.040
- Parot, A., Michell, K., & Kristjanpoller, W. D. (2019). Using Artificial Neural Networks to forecast Exchange Rate, including VAR-VECM residual analysis and prediction linear combination. *Intelligent System in Accounting, Finance and Management*, 26(1), 3-15. doi: 10.1002/isaf.1440
- Tabales, J. N., Carmona, F. R., & Ocerin, J. M. C. Y. (2013). Implicit Prices in Urban Real Estate Valuation. *Revista de la Construcción*, 12(2), 118-128. doi: 10.4067/S0718-915X2013000200009
- Thanasi, M. (2016), Hedonic appraisal of apartments in Tirana. *International Journal of Housing Markets and Analysis*, 9(2), 239-255. doi: 10.1108/IJHMA-03-2015-0016
- TopReality (2019). *Vyhľadavanie: Reality predaj*. Retrieved from <https://www.topreality.sk/vyhľadavanie-nehnutelnosti.html?searchType=string&cat=&form=1&type%5B%5D=101&type%5B%5D=108&type%5B%5D=102&type%5B%5D=103&type%5B%5D=104&type%5B>

%5D=105&type%5B%5D=106&type%5B%5D=109&type%5B%5D=110&type%5B%5D=107&obec=1247&distance=&q=&cena\_od=&cena\_do=&vymera\_od=&vymera\_do=&n\_search=search&page=estate&gpsPolygon=

- Yeh, I. C., & Hsu, T. K. (2018). Building real estate valuation models with comparative approach through case-based reasoning. *Applied Soft Computing*, 65, 260-271. doi: 10.1016/j.asoc.2018.01.029
- Yildirim, H. (2019). Property Value Assessment Using Artificial Neural Networks, Hedonic Regression and Nearest Neighbors Regression Methods. *Selcuk University Journal of Engineering, Science and Technology*, 7(2), 387-404. doi: 10.15317/Scitech.2019.207
- Yu, H., & Wilamowski, B. (2011). Levenberg-Marquardt training. In B. M. Wilamowski & J. D. Irwin (Eds.), *Intelligent Systems*. New York: CRC Press.
- Yucesan, M., Gul, M., & Celik, E. (2017). Application of Artificial Neural Networks Using Bayesian Training Rule in Sales Forecasting for Furniture Industry. *Drvna industrija: Scientific Journal of Wood Technology*, 68(3), 219-228. doi: 10.5552/drind.2017.1706

### Contact information

#### **Mgr. Michaela Štubňová**

Constantine the Philosopher University in Nitra, Faculty of Natural Sciences  
Tr. A. Hlinku 1, 94974, Nitra, Slovak Republic  
E-mail: mstubnova@ukf.sk  
ORCID: 0000-0001-9215-299X

#### **doc. RNDr. Marta Urbaníková, CSc.**

Constantine the Philosopher University in Nitra, Faculty of Natural Sciences  
Tr. A. Hlinku 1, 94974, Nitra, Slovak Republic  
E-mail: murbanikova@ukf.sk  
ORCID: 0000-0001-7884-2257

doi: 10.7441/dokbat.2019.104

# THE NEW INSIGHT INTO COMPLEX CUSTOMER LOYALTY MEASUREMENT

*Eva Tylečková, Jaroslav Nenadál*

## **Abstract**

This paper focuses on complex approach to customer loyalty measurement. The complex approach includes emotional aspects of customer loyalty as well as rational aspects. The results of analysis of the approach of Czech organizations to measuring customer loyalty are also part of this paper. The realized analysis shown that only a few of Czech organizations systematically measure and regularly evaluate complex customer loyalty. One of the reasons of such poor findings might be the fact there do not exist any comprehensive methodology to implement customer loyalty measurement to an organization. For this reason, the aim of this paper is to present new methodology for the measurement of complex customer loyalty. The proposed methodology is mainly based on an approach to measuring loyalty through customer's future intentions, that represents the best option to predict customer's behaviour in the future. Furthermore, the proposed methodology is also based on a distinction of three loyalty types, namely advocacy loyalty, purchasing loyalty and retention loyalty. Knowing the current level of each of these three loyalty types offers an opportunity for predicting customer's future purchasing behaviour, better targeting of marketing and adjusting strategies to current needs.

**Keywords:** *complex customer loyalty, loyalty measurement, advanced quality management systems*

## **1 INTRODUCTION**

Nowadays the established quality management system is commonplace for many organizations. With the increasing use of quality tools and methodologies, the conception and purpose of the quality management systems has also changed. Existing management systems should no longer serve only to meet customers' requirements, but should guarantee continuous improvement in all business areas, meeting the expectations of all stakeholders and of course achieving better results. In an effort to maximize their performance, many organizations are looking for inspiration in advanced quality management systems as well as in excellence models – in the European environment especially in EFQM Excellence Model.

Within advanced quality management systems, including EFQM Excellence Model, feedback evaluation is emphasized. Organizations should receive signals about the perception of their products or services from all stakeholders, however getting feedback from external customers is truly crucial. Customer loyalty measurement represents one of the important procedures in evaluating feedback in advanced quality management systems. Unfortunately, the widespread ISO 9000 series of standards do not include customer loyalty at all. Even the latest edition of ISO 9001 standard from 2015 includes the requirement to obtain feedback only through customer satisfaction measurement (International Organization for Standardization [ISO], 2015). By measuring customer satisfaction only information about customers past experience is collected. Satisfaction measurement does not provide any information about customer's future intentions and cannot be used for effective planning of organization's future strategies.

Moreover, organizations whose customers claimed high satisfaction, may experience high churn rate and loss of market share, as several studies shown (Garfield & Levy, 2013; Hill & Alexander, 2017).

On the contrary, customer loyalty measurement results allow organization to identify customer's future intentions and predict their behaviour, compare the level of loyalty of each customer segments, identify opportunities for improvement and effectively target marketing strategies. If customer loyalty measurement is performed on a regular basis and measurement outcomes are used to manage and plan the strategy of the organization, the final consequences of loyalty ought to be stabilization of the customer base, acquire new customers, cost reduction, increasing market share, growth and ultimately business growth. Despite this list of possible benefits, the established and regularly applied customer loyalty measurement is rather a rarity in the Czech Republic, as will be further confirmed by the survey results. One of the reasons for this finding is the absence of a comprehensive methodology that would provide organizations with clear guidance on the effective implementation of customer loyalty measurement. The introduction of such methodology is the main aim of this paper.

## **2 THEORETICAL BACKGROUND**

The core term "customer loyalty" was defined by many authors, of all existing definitions, let us mention at least a few. Kotler and Keller defined loyalty as "the will to buy again a preferred product or service" (Kotler & Keller, 2013). This will can be driven both by subjective influences that originate in human emotions and attitudes and by objective influences that are based on rational considerations. These subjective influences create emotional loyalty, while objective influences make rational loyalty. Emotional loyalty is based on emotions and positive feeling about supplier's organization, brand or product. Except for emotions and feelings, emotional loyalty also reflects attitudes, which is why it can be found in literature also as attitudinal loyalty (Zhang, 2018). Emotional (or attitudinal) loyalty is defined as "a buyer's overall attachment or deep commitment to a product, service, brand, or organization" (Briggs, Landry, & Daugherty, 2007). It was also confirmed that emotional (attitudinal) loyalty is a mediator of overall loyalty in business to business area (Bardauskaite, 2014). Rational loyalty is based mainly on previous own positive experiences with the organization or product. It can be named also as behavioural loyalty, due to the main impacts of this type of loyalty is customer's behaviour. Behavioural loyalty can be defined as "the willingness of average business customers to repurchase the service and the product of the service provider and to maintain a relationship with the service provider/supplier" (Rauyruen & Miller, 2007).

According to other definition, loyalty is "a collection of attitudes aligned with a series of purchase behaviours that systematically favour one entity over competing entities" (Watson et al., 2015). Like this definition states, loyalty is a collection of both, the attitudes and series of behaviour, which means it would be right to understand emotional and rational loyalty as two dimensions of overall or complex loyalty. Just as customers are complex beings, their loyalty measurement needs to be complex. From this reason, the paper is based on approaches to measurement of complex customer loyalty, that includes both, emotional and rational incentives. As some studies shown, the emotional motivation of customers is more important and stronger to overall loyalty than rational motivations (Čater & Čater, 2009). Other study confirmed there is a positive and significant relationship between emotional and rational loyalty (Russell-Bennett, McColl-Kennedy & Coote, 2014). However, customer loyalty measurement ought to always include both, emotional and rational aspects of loyalty.

According to Hayes (2008), customer loyalty is "twofold customer behaviour resulting in an effective continuation and development of a business relationship in the one hand and in the recommendation of the supplier, its brand, products or services to any potential customers on the other hand". A definition of loyalty can be found also in the EFQM Excellence Model, that defines loyalty as: "a way of future customer behaviour, exhibited by repetitive purchases and



positive references” (European Foundation for Quality Management [EFQM], 2003). From these definitions it can be concluded that effective measurement and monitoring of customer loyalty leads to repeated purchases, improving the image of the organization, attracting new customers and hence business growth.

Over the past two decades several approaches to customer loyalty measurement have been developed. For instance, a measurement through loyalty effects, loyalty index or customer loss, these approaches were specified by Nenadál (2015). Another approach was introduced by Hayes (2009). The measurement through customer’s future intentions seems to be the best option to predict future customer’s behaviour and is applicable to both, business to business and business to customer area. Hayes identified three loyalty types with regard to the future customer’s behaviour (Hayes, 2009). These three types are: advocacy loyalty, purchasing loyalty and retention loyalty.

Advocacy loyalty can be characterized as a degree to which customers will be advocated supplier’s organization, its products or brand. Customers with high level of advocacy loyalty recommend products and organization, by which could be attracted new customers. The consequence of advocacy loyalty is the spread of positive references, thanks to which the image of an organization grows and thus the new customers are acquired, hence resulting in increasing the size of the customers base. Purchasing loyalty can be defined as a degree to which customers will increase their purchasing behaviour and make repeated purchases. This loyalty type is based on customer’s previous positive experience and can lead to increase the amount of purchases made by customers. Retention loyalty reflects the degree to which customers will remain with current supplier’s organization. The consequence of this loyalty type is an increase of the customer lifetime value and an increase of the average length of customer relationships. Each of three loyalty types might be measured by one or a set of proper indicators. For each indicator must be defined a suitable formula. The appropriate indicators of advocacy loyalty are: likelihood to choose again, likelihood to recommend, level of trust, overall satisfaction or customer acquisition rate. For example, the formula for calculating likelihood to recommend  $L_R$  would be:

$$L_R = \frac{N_R}{n} \quad (1)$$

When:

$N_R$  – number of customers who declared that they will recommend organization or its product,  
 $n$  – sample size (total number of customers participated in survey).

As indicators of purchasing loyalty type can be used: likelihood to continue purchasing same products, likelihood to purchase more expensive products or different products, likelihood to increase frequency or amount of purchases, up-selling ratio and repeat purchase rate. An example of formula for calculation of likelihood to increase frequency of purchase  $L_{IF}$  is:

$$L_{IF} = \frac{N_{IF}}{n} \quad (2)$$

When:

$N_{IF}$  – number of customers who declared that they will increase the frequency of purchases,  
 $n$  – sample size.

Suitable indicators for retention loyalty type are: likelihood to switch to another provider, likelihood to stop purchasing from current organization, customer lifetime value, retention rate,

defection rate, customer churn rate, revenue retention, customer attrition rate. For instance, the retention rate RR for the investigated period (for example a month, a quartal or a year) should be calculated due to formula:

$$RR = \frac{C_E - C_A}{CS} \times 100[\%] \quad (1)$$

When:

$C_E$  – number of customers at the end of the period,

$C_A$  – number of customers acquired during this period,

$CS$  – number of customers at the start of period.

It was also confirmed that identification of each loyalty type can lead to business grown. Each of three loyalty types leads to some positive effects for organization. Advocacy loyalty leads to increasing number of recommendations by which can be also increasing size of the customer base. Purchasing loyalty is linked to increasing purchasing behaviour, by which can be increasing also number of purchases. Retention loyalty might be expressed as decreasing churn rate, that will lead to increasing length of customer lifetime. More about the positive effects of each type of loyalty was described by Hayes (2009).

Besides all possible effects mentioned above, the connection between customer loyalty and efficient quality management was confirmed by Rauyruen and Miller (2007). The relationship between loyalty and profit was investigated by Kumar and Shah (2004). Moreover, clear linkage between customer loyalty and overall supplier organization's performance was approved by several studies (Hayes, 2009; Reinartz & Kumar, 2011).

Most of the customer loyalty studies were conducted within business to customer (B2C) context. The gap between published articles dealing with customer loyalty in business to business (B2B) context and articles about loyalty in general was described by Bardauskaite (2014). A minimum number of customer loyalty studies from B2B is also refers to the fact that mostly the organizations are not very concerned with this topic. To find out how Czech organizations approach to measuring the complex loyalty of their customers, an analysis was conducted.

### **3 ANALYSIS OF THE APPROACH TO COMPLEX CUSTOMER LOYALTY MEASUREMENT AT CZECH ORGANIZATIONS**

The approach of Czech organizations to complex customer loyalty measurement was analysed through a questionnaire survey that was conducted during November 2018.

#### **3.1 Methodology**

On the purpose of find out how organizations in the Czech Republic approach to complex customer loyalty measurement, a hypothesis was determined:

*H1: The complex customer loyalty measurement is rarely established at Czech organizations.*

This hypothesis was tested by a research, which was comprised of data gathering based on structured questionnaire. The questionnaire consisted of 4 open and ten closed questions, that counts 14 questions in total. The first four segmentation questions were focused on the general characteristics of the interviewed organization – specifically its size (by number of employees), business area, key customers and system certificates owned by the organization. The rest of question was focused on the organization's own approach to customer loyalty measurement. In

the case that some organization's processes do not include customer loyalty measurement, this organization was asked to explain the reasons. The organizations reporting that they measure customer loyalty were also asked about the reasons that led them to implement this type of measurement. In the following questions, these organizations were asked about more detailed information about their approach to measuring loyalty. The questionnaire itself was preceded by a cover letter explaining the meaning and purpose of the survey, including a definition of loyalty according to EFQM and also some proven facts related to customer loyalty were mentioned. The questionnaires were distributed mainly electronically to the randomly selected organizations which do business in Czech Republic. The representatives of some organizations were approached directly, during professional conferences or educational seminars. The whole methodology and results of this analysis was published in master's thesis by Tylečková (2019).

### 3.2 Results

Over the course of the survey, that means during November 2018, a total of 230 organizations were approached. In total, 65 completed questionnaires were received during the survey, that means a response rate was 28%. The business area of involved organizations was diverse, as can be seen from Figure 1.

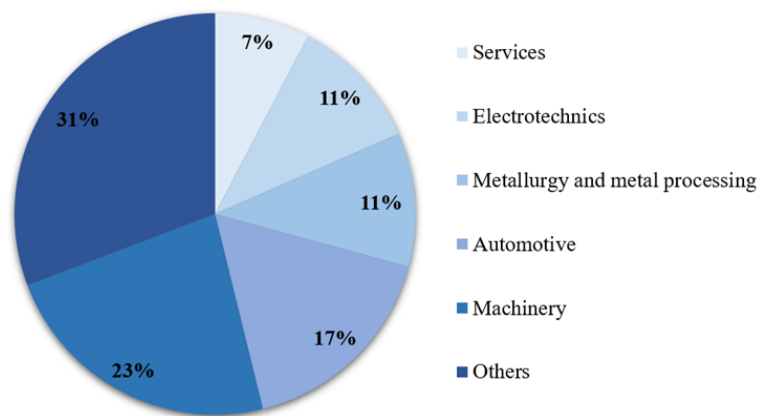

Fig. 1 – Distribution of organizations by business area. Source: own research

The main finding of the survey is the fact that only 10 of the 65 (that means 15%) organizations systematically measure complex customer loyalty in the Czech Republic. The main reasons that led these organizations to establish this measurement are shown in Table 1.

Tab. 1 – The reasons why organizations measure complex customer loyalty. Source: own research

Reason	Frequency
Customer focus	3
Improving customer communication	2
Management decision	2
Customer relationship management development	1
Requirement of excellence model	1
Sales department request	1
Not specified	2

As is clear from the Table 1, Czech organizations primarily implement complex customer loyalty measurement as a contribution to customer focus that is also one of the quality management principles. The reasons why most of interviewed organizations does not approach to complex customer measurement are shown in Table 2. Unfortunately, hypothesis H1 was confirmed by the survey.

Tab. 2 – The reasons why organizations does not measure complex customer loyalty. Source: own research

Reason	Frequency
Unknown / Not answered	14
It is not required	7
Owners or managers do not require it	5
Our customers do not require it	4
Top management is not interested in such measurement	4
There is no need to investigate this feedback	4
Such measurement is provided by distributors	3
Contracts are obtained on basis of competitive tendering	3
Monopoly status	2
It is not required by international standards	2
Our company is not supplier for end customers	2
Complex loyalty measurement is not key for our business	2

### 3.3 Discussion

The analysis also examined the development of the approach of Czech organizations to the complex customer loyalty measurement. From this reason, nest hypothesis H2 was formulated:

*H2: The approach of Czech organizations to the complex customer loyalty measurement is not improving over time.*

The results of the survey were confronted with the results of a similar research of loyalty perception that was carried out in 2012 and was published by Vykydal, Halfarová and Nenadál (2013). Comparison of conducted surveys offers a comprehensive view on the development of the attitude of Czech organizations to monitoring and evaluating customer loyalty. Main characteristics of both researches are summed up to Table 3.

Tab. 3 – Comparison of research findings from 2012 and 2018. Source: own research

Item	2012	2018
Total number of organizations selected for the research	183	230
Total number of organizations with relevant response	34	65
Response rate	18%	28%
Total number of organizations which perform customer loyalty measurement	10	10
Ratio of organizations which perform customer loyalty measurement from total number of organizations with relevant response	29%	15%

The comparison of research findings from 2012 and 2018 discovered that the approach of Czech organizations to the complex customer loyalty measurement is truly not improving over time. While 29% of organizations involved in survey in 2012 measured customer loyalty, six years later, just 15% involved organization measured customer loyalty. To sum up, H2 was confirmed and the approach of Czech organization to the complex customer loyalty is even getting worse over time.

One of the possible reasons why so few Czech organizations are concerned in customer loyalty might be fact, that there is no comprehensive methodology to establishing this kind of measurement. Due to this, next part of this paper is dedicated to introduction of a new methodology for complex customer loyalty measurement – from its implementation to evaluating and using results.

## 4 PROPOSED METHODOLOGY OF COMPLEX CUSTOMER LOYALTY MEASUREMENT

The proposed methodology of complex customer loyalty measurement consists of 12 steps:

- 1) Top management decision making.
- 2) Selection of products for complex customer loyalty measurement.
- 3) Customer segmentation.
- 4) Determination of measurement frequency.
- 5) Choosing an approach to complex customer loyalty measurement.
- 6) Design of customer loyalty indicators.
- 7) Questionnaire development and testing.
- 8) Data gathering.
- 9) Data evaluation and customer's assessment.
- 10) Communication of measurement results.
- 11) Planning and implementation of appropriate actions.
- 12) Analysis of loyalty changes to organizational performance.

Each step of the proposed methodology is briefly described below.

The decision to implement complex customer loyalty measurement should come from the organization's top management. The involvement of top management plays a key role in effective building, measuring and evaluation of loyalty measurement. The top managers role is also needed to assign responsibilities and authorities regarding the activities focused to customer loyalty measurement and release required resources like people, data and money.

Due to fact that most of today's organizations offer a broad product portfolio, it is appropriate, especially when initially implementing a loyalty measurement methodology, to focus only on selected products. During selection of products for loyalty measurement should be considered volume of product sales, total product revenue and its profitability, and the impact of the product's sales to overall business performance.

It is not necessary to involve all existing customers in the loyalty measurement; however key customers should definitely be involved. Customer segmentation can be done due to CLV (customer lifetime value), that seems to be the best criterion as stated by Bejou, Keiningham and Aksoy (2006).

When determining the measurement frequency, the business area should be considered. In areas characterized by the fast development of new products, such as electrical engineering or information technology, it is preferable to measure customer loyalty at shorter intervals – one a year or more often. On the contrary in areas where product lifetime is in the order of years, for example in the field of arms production, it may be enough to measure loyalty with a frequency of less than once a year. In addition to the business area, the frequency of deliveries and their size should also be taken into consideration.

The topic of loyalty and its measurement have been developing for many years, therefore today organizations can choose from various approaches to complex customer loyalty measurement. In the initial phase of measuring loyalty, it may be appropriate to use the loyalty measurement approach through the loyalty index. The benefit of this approach is the possibility of comparing the values of customer satisfaction and loyalty, which often differ. Other possibility is to measure loyalty through customer's future intentions. So far, this approach describes best both, emotional and rational aspects of customer loyalty. In addition, this approach uses objective loyalty indicators, that are associated with a minimum measurement error, a clear interpretation and the ability to calculate indices of each loyalty type, as well as the overall loyalty rate. Some

other approaches to loyalty measurement also can be useful, for instance measurement through loyalty effects, customer loss or loyalty index – more information about these approaches was written by Nenadál (2015). Each organization ought to choose one approach or suitable combination of several approaches, according to its specific needs. It is also possible to include measurement through net promoter score or customer effort score, which are on the one hand simpler than other mentioned approaches, but on the other hand they are also less reliable while using separately – more information about these methods can be found in literature (Reichheld & Markey, 2011).

When designing of customer loyalty indicators, indicators based on data that organization usually monitors can be used, without the need to address the customers. Such indicators include a change of market share of own products, number of new customers, the number of newly acquired customer, and many others. The advantage of these indicators is the possibility of calculation without the need to collect data from customers. However, these indicators are only quantitative and reflect past customer behaviour. Monitoring the evolution of these indicators over longer term may provide some information about the performance of the organizations, but without finding the reasons for changes to these indicators, the organization does not have the ability to respond appropriately. The proposed methodology is therefore based on the approach to measuring customer loyalty through customer's future intentions, which can be used for prediction of future customer's behaviour. This approach is based on a distinction between three loyalty types, so each of indicators is related to one of these types.

After proper indicators are designed, a questionnaire can be developed. Questionnaire must comprise such set of questions that cover all loyalty indicators selected in a previous step. Besides developing questions, it is necessary to choose the appropriate response format. For complex customer loyalty measurement, the most appropriate seems to be a Likert-Type format due to its simplicity, utility and objectivity. As for recommends using response scale with 4 or 5 levels (Hayes, 2008). A developed questionnaire should comprise accompanying part that specifies the purpose of the survey, instructions how to complete it, deadline and the ways to submit. Before releasing, the questionnaire must be tested for its complexity, correctness and comprehensibility.

Before data gathering it is necessary to choose proper method of questionnaire distribution. Owing to technology innovations in recent years, customer loyalty may be assessed through web-based surveys which, unlike paper-based, are characterized by greater availability and faster processing. If it is not possible to involve all customers in the survey, a customer sampling must be carried out. In such case, organizations may use judgmental or statistical sampling. For the highest objectivity of measurement some of statistical sampling (for example simple random, stratified or cluster) should be preferred. More detailed information and a practical guidance for these activities were described by Hayes (2008).

After data gathering, all data received from the survey must be evaluated by appropriate way. Relevant statistical methods might be usable in this step. Based on the evaluated data it is possible to assess customers according to their future intentions and expected behaviour. The output of data evaluation should be a set of data comprised of complex loyalty indicators regarding to each of the key customer, progress and trends of customer loyalty over time, root cause analysis of loyalty changes.

The measurement results and customer feedback data need to be communicated through organization. The proper way how to communicate results internally is by management review process, that is also a requirement by ISO 9001 standard (ISO, 2015).

Following communication of measurement results, the top management team ought to identify opportunities for improvement and proposed corrective actions, if necessary. The specific actions to increase level of loyalty in the future should be also planned.

The last step of proposed methodology is an analysis of loyalty changes to organizational performance. Some researches already claimed that organizations whose customers are loyal, experience faster business growth (Hayes, 2009). There is a clear linkage between customer loyalty, showed through recommendations, attracting new customers, repeating purchases, increasing number of purchased products, and economic results. Therefore, the outputs from complex customer measurement and changes in loyalty indicators should be analysed regard to organizational performance. Unfortunately, the survey of Czech organizations, described above, did not show that any of interviewed organization does such analysis. The reasons can be seen in fact that an analysis of loyalty changes to organizational performance requires huge quantity of input data from the long term, suitable software support for data processing and necessary knowledge of statistical methods for data evaluation.

## **5 RESULTS AND CONCLUSION**

The proposed methodology provides a common universal framework that is applicable to all types of organizations. The methodology provides guidance on: implementing complex customer loyalty measurement for B2B as well as B2C organizations, the process of data gathering and evaluating the level of customers loyalty with respect to all aspects of their future behaviour. Furthermore, the proposed methodology offers a possibility to categorize customers not only within three types of loyalty but also according to the level of emotional and rational loyalty, which differs this methodology from the current methods for measuring loyalty.

The outputs from complex customer loyalty measurement might be used to making objective strategic decisions and analysing of changes in organization's performance. Understanding the customer's core role for business growth is crucial if any organization wants to survive in today's competitive environment. Knowing the current level of customer loyalty is also a way for supplier's organization to predict customer's future purchasing behaviour and adjust their plans and marketing strategies to current needs.

To sum up customer loyalty brings numerous positive effects to the supplier organization that lead to business growth. At present only few Czech organizations measure the level of their customer loyalty. However, it cannot be excluded that Czech organizations' interest in customer loyalty measurement will gradually increase in the future, as the requirements for quality management systems continue to increase. The methodology introduces in this paper can contribute to the future use of customer loyalty measurement. Verifying proposed methodology in practice remains the task for future and due to confirmed low interest of Czech organizations in loyalty measurement, this task will be challenging. The further research may be focused on the use of the proposed methodology in practice – especially in the business to business context.

### **Acknowledgement**

This paper is an output of project SP 2018/97 “Development of selected areas of modern quality management systems”, that was solved at Faculty of Material Science and Technology of VŠB – Technical University of Ostrava.

## References

- Bardauskaite, I. (2014). Loyalty in the business-to-business service context: A literature review and proposed framework. *Journal of Relationship Marketing*, 13(1), 28-69. doi: 10.1080/15332667.2014.882628
- Bejou, D., Keiningham, T. L., & Aksoy, L. (2006). *Customer lifetime value: reshaping the way we manage to maximize profits*. Binghamton: Best Business Books.
- Briggs, E., Landry T. D., & Daugherty P. J. (2007). Patronage in continually delivered business service contexts. *Journal of Business Research*, 60(11), 1144-1151. doi: 10.1016/j.jbusres.2007.04.005
- Čater, B., & Čater T. (2009). Emotional and rational motivations for customer loyalty in business-to-business professional services. *Service Industries Journal*, 29(8), 1151-1169. doi: 10.1080/02642060902764780
- European Foundation for Quality Management (2003). *EFQM Excellence Model*. Retrieved from <https://www.efqm.org/>
- Garfield, B., & Levy, D. (2013). *Can't buy me like: How authentic customer connections drive superior results*. London: Penguin Group.
- Hayes, B. E. (2009). *Beyond the ultimate question: a systematic approach to improve customer loyalty*. Milwaukee: ASQ Quality Press.
- Hayes, B. E. (2008). *Measuring customer satisfaction and loyalty: survey design, use, and statistical analysis methods*. Milwaukee: ASQ Quality Press.
- Hill, N., & Alexander, J. (2017). *The Handbook of Customer Satisfaction and Loyalty Measurement*. London: Routledge.
- International Organization for Standardization (2015). *ISO 9001:2015 Quality management systems – Requirements*. Retrieved from <https://www.iso.org/home.html>
- Kotler, P., & Keller, K. L. (2013). *Marketing management*. Praha: Grada.
- Kumar, V., & Shah D. (2004). Building and sustaining profitable customer loyalty for the 21st century. *Journal of Retailing*, 80(4), 317-329. doi: 10.1016/j.jretai.2004.10.007
- Nenadál, J. (2015). Development of customer loyalty measurement at Czech companies. *Modern Machinery (MM) Science Journal*, 2015(03), 659-664. doi: 10.17973/MMSJ.2015\_10\_201531
- Rauyrueen, P., & Miller, K. E. (2007). Relationship quality as a predictor of B2B customer loyalty. *Journal of Business Research*, 60(1), 21-31. doi: 10.1016/j.jbusres.2005.11.006
- Reichheld, F. F., & Markey, R. (2011). *The ultimate question 2.0: How net promoter companies thrive in a customer-driven world*. Boston: Harvard Business Review Press.
- Reinartz, W., & Kumar, V. (2011). *The mismanagement of customer loyalty*. Boston: Harvard Business Review Press.
- Russell-Bennett, R., McColl-Kennedy, J. R., & Coote, L. V. (2007). Involvement, satisfaction, and brand loyalty in a small business services setting. *Journal of Business Research*, 60(12), 1253-1260. doi: 10.1016/j.jbusres.2007.05.001
- Tylečková, E. (2019). *Rozvoj přístupů k měření komplexní loajality zákazníků v průmyslových organizacích*. Ostrava: VSB – Technical University of Ostrava.



- Vykydal, D., Halfarová, P., & Nenadál, J. (2013). Customer loyalty measurement at Czech organizations. *Quality Innovation Prosperity*, 17(1), 28-38. doi: 10.12776/qip.v17i1.66
- Watson, G. F., Beck, J. T., Henderson, C. M., & Palmatier, R. W. (2015). Building, measuring, and profiting from customer loyalty. *Journal of the Academy of Marketing Science*, 43(6), 790-825. doi: 10.1007/s11747-015-0439-4
- Zhang, Z. (2018). *Global information diffusion and management in contemporary society*. Plattsburgh: IGI Global.

### **Contact information**

#### **Ing. Eva Tylečková**

VSB – Technical University of Ostrava, Faculty of Material Science and Technology  
17. listopadu 15, 70833, Ostrava  
E-mail: eva.tyleckova@vsb.cz  
ORCID: 0000-0003-3583-2678

#### **prof. Ing. Jaroslav Nenadál, CSc.**

VSB – Technical University of Ostrava, Faculty of Material Science and Technology  
17. listopadu 15, 70833, Ostrava  
E-mail: jaroslav.nenadal@vsb.cz  
ORCID: 0000-0003-1526-8694

doi: 10.7441/dokbat.2019.105

# TRAFFIC MICROSCOPIC SIMULATION IN THE TOWN KYJOV

*Gabriela Tylová, Kateřina Víchová*

## **Abstract**

The paper deals with the microscopic simulation in the selected town - Kyjov. Firstly, there is discussed a short literature review about traffic simulation. Secondly, there is an introduced methodology. For this paper was used the simulation software PTV Vissim. This software is mainly for the microscopic simulation. The next part is presented results from the selected intersection in the town Kyjov. Finally, there is simulated construction of the new logistics centre and the impact of the traffic on the chosen intersection in the city.

*Keywords: PTV Vissim, simulation, model, intersection, traffic*

## **1 INTRODUCTION**

Transport infrastructure is influenced by historical, political, cultural, structural, and economic aspects of urban development. In modern conditions, traffic intensity and transport composition undergo significant changes. Traffic intensity is noted as the first and primary determinant of traffic safety. (Volkova & Stepanenko, 2019)

This paper deals with simulation in software PTV Vissim. The aim of the paper is to simulate the intersection and traffic situation, which will be created by the construction of a logistics centre, but mainly to illustrate the traffic situation at the intersection in the town of Kyjov and approach simulation creation in PTV Vissim. I chose this intersection because it is one of the busiest intersections in Kyjov. The simulation is based on the map of the intersection in Kyjov. The intersection is located in the centre of Kyjov in the Hodonín district in the South Moravian Region. Road I / 54 on which intersection on lead from Slavkov u Brna to Strani and further to Slovakia to Nove Mesto nad Vahom. Here cross Nerudova Street with Kollárova Street and Jiráskova Street. PTV Vissim is software for microscopic simulation of public transport, including, for example, cars and trucks, buses, cyclists, or pedestrians. It is mainly used in the assessment of transport infrastructure designs and traffic management on roads. The aim of the paper will be present the current state of the selected intersection and the impact for the traffic flow in the city.

## **2 METHODOLOGY**

In this paper was used several methods. Firstly, there was used method of analysis, where we must analyse the current state of the traffic in the city. Secondly, there was used methods of modelling and simulation of traffic flow. Finally, for the simulation, where was used the simulation software PTV Vissim.

### **2.1 Modelling and simulation of traffic flow**

Firstly, there was used modelling and simulation of traffic flow. Simulation is a method based on experimenting with a model of the real system under investigation to obtain information about the behaviour of such a policy (the “what happens if...” method). (Lipka, 2015; VSB, 2009a)

Simulation is an imitation of the behaviour of real system development over time. Simulation is used when designing new systems (if it is cheaper than prototyping); to determine system

requirements (sizing for different types of loads, both computers and transport networks); for training in the use of existing systems (it can be expensive to be played with); to modifications of existing systems (the introduction of new rules, adding new capacities); when an analytical model cannot be found. (Lipka, 2015; VSB, 2009a)

Traffic modelling and simulation is primarily used in traffic engineering and traffic planning. The aim is to create a model of transport in a given territory that could be used to simulate prospective transport relations or to verify alternative designs and adjustments. Transport models can be used in the design of transport infrastructure (geometric and width layout of the communication network), public transport design (introduction of new lines, location of stops, etc.), or environmental impact assessment. (Volkova & Stepanenko, 2019; Koglin, 2015; VSB, 2009a; Cools, Moons & Wets, 2010)

The basis of the traffic models is for the given purposes to model faithfully the movements of vehicles and their interaction. However, it is not possible to create a single universal model that can be used to model all situations. The main criteria are the extent of the modelled network, the degree of approximation to the real state, and the display of detail. (Volkova & Stepanenko, 2019; Koglin, 2015; VSB, 2009a; Cools, Moons & Wets, 2010)

Nano and microsimulation tools dominate the representation of the real state. For significant network analysis, modelling with these tools is disproportionately demanding and unnecessarily detailed, so it is preferable to use a higher degree of generalization using macro-simulation tools. For large-scale networks, it is desirable to generalize some of the details, and so the so-called abstraction is regularly applied. Typical examples of such generalizations in macroscopic models are, for example, intersections. These are perceived only as nodes within these networks, without a more detailed influence of their arrangement. Conversely, in nano or micro-simulation models, intersections can be modelled to the smallest detail. Microsimulation using validated data allows a better approximation to reality than macrosimulation, which in turn provides more reliable and realistic data in bulk and summarizing results such as intensity, density, or speed of traffic flows. (Volkova & Stepanenko, 2019; Koglin, 2015; VSB, 2009a; Cools, Moons & Wets, 2010)

Simulations are divided into static (time is not necessary, the model always behaves the same way), dynamic (the system evolves, some features may change), macroscopic (monitor only aggregate values, e.g. network flows), mesoscopic (monitor the behaviour of homogeneous groups of objects, e.g. motorway columns), microscopic (track individual entities, e.g. individual vehicles), nanoscopic (detailed monitor behaviour of entities, e.g. driver decision-making modelling). (Lipka, 2015; VSB, 2009a)

The principles of microscopic simulation consist of calculating the movement of individual vehicles based on interactions with other cars. These simulations are based on mathematical models that take into account all available parameters of the transport network, vehicles, or driver behaviour. Each vehicle entering the modelled system during the simulation is unique and assigned specific characteristics such as destination, vehicle type, and behaviour, speed, etc. Microscopic simulations are very hardware intensive in this respect. The main representatives of microscopic simulation tools include VISSIM, PARAMICS, or AIMSUN. (Lipka, 2015; VSB, 2009a; VSB, 2009b)

## **2.2 PTV Vissim**

PTV VISSIM is a microscopic simulation tool developed by the German company PTV AG in cooperation with the Technical University of Karlsruhe. It is software for microscopic simulation of individual and public transport. Thanks to its high level of detail processing, it

could accurately simulate both city traffic, including cyclists and pedestrians, as well as highway sections, including large grade-separated junctions. (AF CityPlan, 2017; VSB, 2009b)

The software is primarily designed for modelling multimodal traffic flows, including cars and trucks, buses, rail vehicles (trams, trains, high-speed), cyclists, and pedestrians (the essence of VISSIM is Wiedemann's "car-following" model). In Vissim, you could simulate not only car traffic but also interaction with pedestrians and cyclists. It combines traffic-engineering experience with the possibility of presentation in 3D animations. (AF CityPlan, 2017; VSB, 2009b)

Vissim is used to analyse networks of all sizes, from individual intersections to large metropolitan areas. In these transport networks, it could model all functional categories of roads from highways to purpose-built drives. Vissim's scope of application also includes public transport and routes for cyclists and pedestrians. The ability to define an unlimited number of vehicle types allows the user a full range of multimodal operations. Vehicle types include cars, trucks, buses, cyclists, wheelchairs, pedestrians, airplanes, etc. (AF CityPlan, 2017; VSB, 2009b)

VISSIM is frequently used to assess transport infrastructure designs, traffic management design, its analysis, and simulation of telematics benefits in traffic management, public transport simulation, etc. Highly detailed input of traffic network elements allows displaying very accurate and corresponding simulation when the user directly sees the modelled state on the screen. (AF CityPlan, 2017; VSB, 2009b)

### 3 CASE STUDY

The microscopic simulation will take place at a selected intersection in the city Kyjov, Czech Republic. Kyjov currently has more than 11 thousand inhabitants and is a natural administrative and social centre for the other 41 surrounding villages. It is located 40 kilometres southeast of Brno and 18 kilometres north of Hodonín. The small river Kyjovka, also called Stupava, flows through the town. (Město Kyjov, n.d.; Wikipedia, n.d.)



Fig. 1 – Town Kyjov in map. Source: Google Maps (n.d.)

The nearest surroundings of Kyjov have the character of deforested hills with fields, orchards, and vineyards. Only a few kilometres west and north of the city, however, are rising significantly higher, wooded peaks of the Věteřovská Highlands, Ždánický Forest, and the Chřiby Mountains. Kyjov is divided into four parts: the city and three formerly independent villages - Nětčice, Boršov, and Bohuslavice. (Město Kyjov, n.d.; Wikipedia, n.d.)



Fig. 2 – Main Square in Kyjov. Source: Město Kyjov (n.d.)

### 3.1 Transport in the city

The railway line No. 340, also called the Vlárská dráha (Railway), runs through the town from Brno to Uherské Hradiště. A railway line bypasses the city along its western and southern borders. The railway station building from 1887 was reconstructed in 2011. The local part of Bohuslavice has its own railway station called Bohuslavice u Kyjova, and in the southern part of the town near the screw works, there is a railway stop. (Město Kyjov, n.d.; Wikipedia, n.d.)

The bus connection of Kyjov with the surrounding villages was gradually established during the First Republic. Since 1959 there has been a city bus service. Since 19 July 1976, a bus station on Nerudova Street has been in operation. Since 5 January 1998, the terminal has a terminal hall with a waiting room and bathroom. Due to the distance between the bus and train stations (about 1.2 km), a transfer terminal was built at the train station in 2010. (Město Kyjov, n.d.; Wikipedia, n.d.)

Kyjov lies at the crossroads of roads I/54, II/432, and II/422. In 1965, an overpass over the railway line was built on the I/54 road in Kyjov, thus significantly simplifying the city transit. Since 1987, cars have been running along the bypass between the I/54 and II/432 roads in the western part of the city, thereby facilitating traffic in the centre. (Město Kyjov, n.d.; Wikipedia, n.d.)

On the road between Kyjov and Milotice, 3 km south of the city, was built in 1951 public domestic airport Kyjov with a grassy runway. It is operated by the civic association Aeroklub Kyjov. (Město Kyjov, n.d.; Wikipedia, n.d.)

## 4 RESULTS

The results contain several points, how was used the simulation software PTV Vissim. In the next part, there was final simulation of the current state of the selected intersection. Finally, there was added the building of the logistic centre and the impact for the traffic flow in the city.

### 4.1 Current state

For this paper was selected a specific intersection in Kyjov. The intersection is located in the centre of Kyjov in the Hodonín district in the South Moravian Region. Crossing the road (Nerudova Street) I/ 54, leading from Slavkov u Brna to Strani and further to Slovakia to Nove Mesto nad Vahom. Here it crosses with a road passing through Kollárova Street connecting the city centre and Jiráskova Street ending at a screw shop.



Fig. 3 – Aerial map of the intersection. Source: Google Maps (n.d.)

## 4.2 Background images

I made a map clipping and put it in the PTV Vissim. Next, I set a scale on 50 meters.



Fig. 4 – Aerial map of the intersection. Source: Google Maps (n.d.)

## 4.3 Links, pavement markings

A new road has been prepared in Jurovského Street, which will lead to a logistics centre. Subsequently, pedestrian crossings and road markings were added.



Fig. 5 – Links, pavement markings. Source: own research



#### 4.4 Conflict areas, priority rules, signal heads

Besides, conflict areas have been identified, which are where columns and priority rules are formed to indicate which car has priority over the road. Signal heads were then added. They are related to signal controllers, where you set the signal group and signal program, which determines how long each light shines on the traffic light.

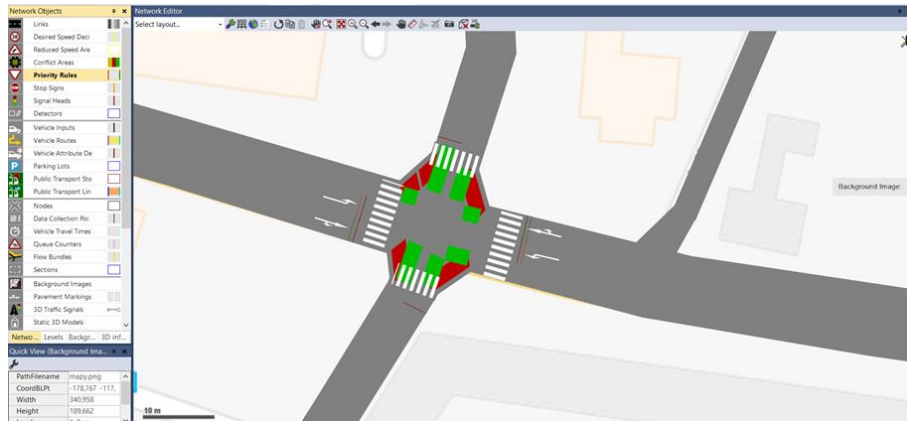

Fig. 6 – Conflict areas, priority rules, signal heads. Source: own research

#### 4.5 Vehicle inputs

In the next step, I added vehicles and set up its volume.

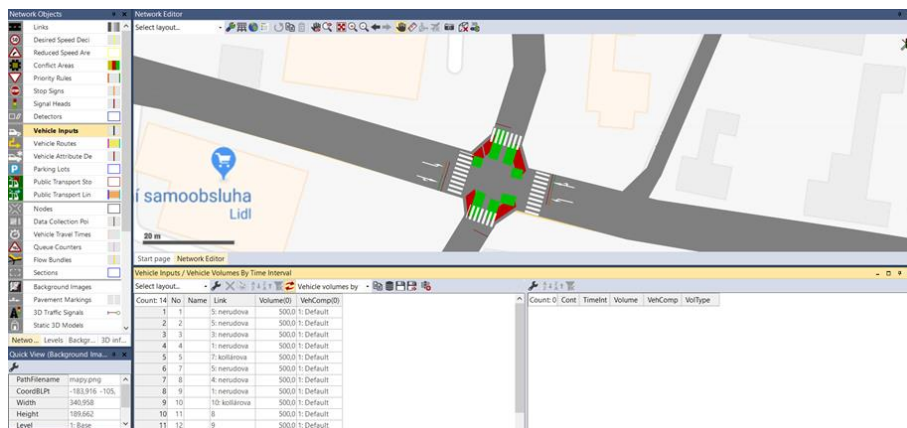

Fig. 7 – Setting up vehicles. Source: own research

#### 4.6 3D simulation



Fig. 8 – Intersection before construction of logistics centre. Source: own research

Figure 8 shows the traffic situation looked like before the construction of the logistics centre, and figure 10, we could see how the traffic at the intersection changed after adding the road to the logistics centre.



Fig. 9 – Intersection after construction of logistics centre. Source: own research

#### 4.7 Static 3D models, 3D traffic signals, signal controllers

In the next step, static 3D objects, including buildings, benches, trees, and flowers, were added, and I created a car park. Then traffic lights for cars and pedestrians were added, and the signalling program was set up.

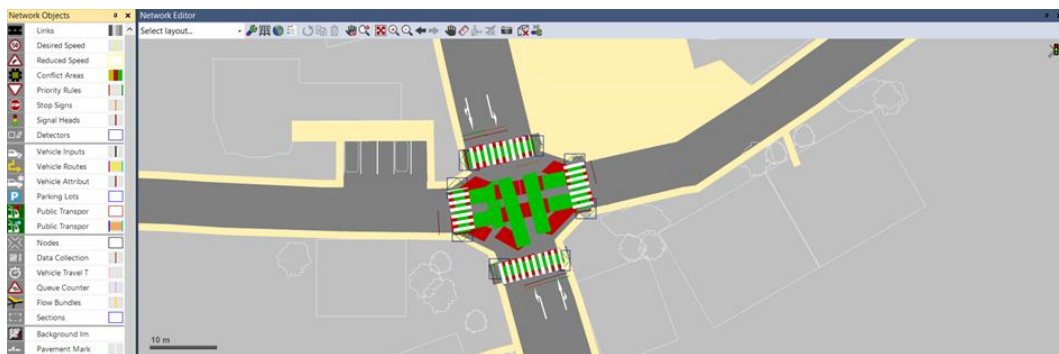

Fig. 10 – Static 3D models, 3D traffic signals, signal controllers. Source: own research



Fig. 11 – Pedestrian routes. Source: own research

#### 4.8 Final 3D simulation

Figure 12 and 13 shows the results from the simulation software PTV Vissim.





Fig. 12 – View of the intersection with pedestrians. Source: own research

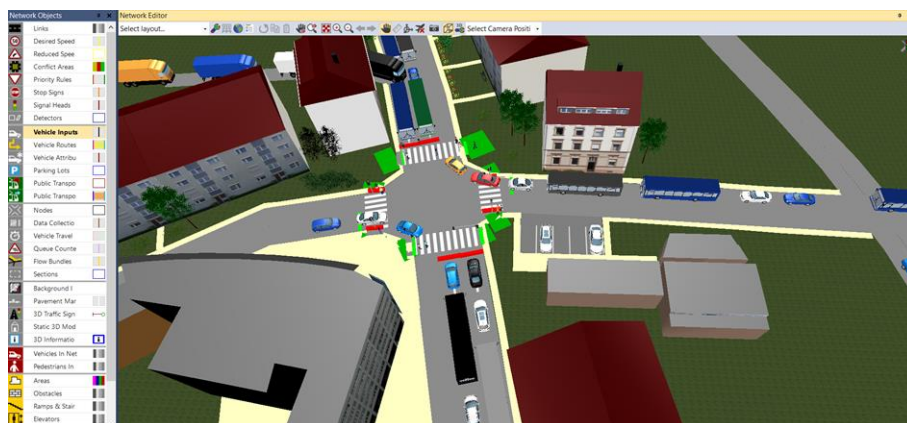

Fig. 13 – View of the intersection. Source: own research

## 5 CONCLUSION

The aim of the paper was to simulate the selected intersection in the city Kyjov and the traffic situation that would arise after the construction of the logistics centre. The simulation was presented based on the simulation software PTV Vissim. The first part involved the creation of a junction and a road leading to a logistics centre. Besides, the intersection was completed with other objects, including signalling equipment, 3D objects, and pedestrians. The thesis describes the simulation procedure and a demonstration of the new situation after the construction of the logistics centre. The simulation shows that trucks will significantly affect the case at the crossroads.

### References

- AF CityPlan (2017). *PTV Vissim*. Retrieved from <http://www.af-cityplan.cz/vissim-1404042539.html>
- Cools, M., Moons, E., & Wets, G. (2010). Assessing the Impact of Weather on Traffic Intensity. *Weather, Climate, and Society*, 2(1), 60-68. doi: 10.1175/2009WCAS1014.1
- Google Maps. (n.d.). Retrieved from <https://www.google.com/maps>
- Koglin, T. (2015). Velomobility and the Politics of Transport Planning. *GeoJournal*, 80, 569-586. doi: 10.1007/s10708-014-9565-7

- Lipka, R. (2015). *Simulace systémů hromadné obsluhy*. Retrieved from <https://courseware.zcu.cz/CoursewarePortlets2/DownloadDokumentu?id=102129>
- Město Kyjov. (n.d.). *Kyjov dnes*. Retrieved from <http://mestokyjov.cz/mesto-pro-zivot-a-navraty/ds-1294/p1=2952>
- Volkova, E., & Stepanenko, A. (2019). Traffic intensity on highway R-255 Siberia in Irkutsk region. *IOP Conference Series Materials Science and Engineering*, 667(1), 012107. doi: 10.1088/1757-899X/667/1/012107
- VSB. (2009a). *Kapitola IV. Modelování dopravy na pozemních komunikacích (ČÁST 1)*. Retrieved from <http://projekt150.ha-vel.cz/node/94>
- VSB. (2009b). *Kapitola IV. Modelování dopravy na pozemních komunikacích (ČÁST 3)*. Retrieved from <http://projekt150.ha-vel.cz/node/96>
- Wikipedia. (n.d.). *Kyjov*. Retrieved from <https://cs.wikipedia.org/wiki/Kyjov>

### Contact information

#### **Gabriela Tylová**

Tomas Bata University in Zlín, Faculty of Logistics and Crisis Management  
Studentské náměstí 1532, 68601, Uherské Hradiště, Czech Republic  
E-mail: [g\\_tylova@utb.cz](mailto:g_tylova@utb.cz)  
ORCID: 0000-0001-8651-6590

#### **Kateřina Víchová**

Tomas Bata University in Zlín, Faculty of Logistics and Crisis Management  
Studentské náměstí 1532, 68601, Uherské Hradiště, Czech Republic  
E-mail: [kvichova@utb.cz](mailto:kvichova@utb.cz)  
ORCID: 0000-0003-3420-9411

doi: 10.7441/dokbat.2019.106

# HOW DOES BOARD DIVERSITY IMPACT PROFITABILITY THROUGH FINANCING DECISIONS? EVIDENCE FROM OIL AND GAS INDUSTRY

*Sorana Vatavu*

## **Abstract**

This paper examines the relationship between board diversity and profitability, related to financing decisions in companies operating in the extraction of crude petroleum and natural gas industry. Specifically, the study is based on 31 companies with subsidiaries in the United Kingdom, over the period 2006-2014. The analysis is realised based on statistics and regressions, employing the gender and age of every board member, as board diversity proxies, return on assets as a performance indicator, and gearing and solvency ratios as proxies for financing decisions. Results indicate an indirect relationship between every gender and profitability. Moreover, regarding the age of the board members, results highlight that only the members from age groups 36-45 and 56-65 have a positive influence on corporate performance, while the members of different ages diminish profitability. By also referring to financing decisions, results indicate that more impact on performance comes from young board members (of 36-45 age group), who tend to avoid debt. This research yields significant insights into the association between board diversity and profitability. First, there is no evidence for better performance in case more females or more males are in the Board of Directors. On the contrary, fewer board members would improve the returns of the companies. Secondly, the most effective board members are either the middle-aged ones or those who are close to retirement. Both categories may be associated with individuals who understand the current conditions and undertake adequate decisions or those with most professional experience. The findings of this study suggest that, in order to achieve sustainable performance, the board dimension should be minimised while its members should be flexible and experienced.

*Keywords: board diversity, corporate governance, profitability, sustainability*

## **1 INTRODUCTION**

From this year, financial reporting considers the new principles and provisions mentioned in the corporate governance 2018 Code developed in the United Kingdom (Financial Reporting Council, 2018). This Code was considered to promote business transparency and integrity, undertaking measures that attract investments for sustainable growth in both the economy and society. Besides the fact that governance emphasises the importance of a strong relationship between shareholders and stakeholders, governance strategies now focus more on the corporate culture, board diversity and composition, and remuneration based on success.

The presence of women on boards and their impact on board effectiveness have raised the interest of many researchers. Although there is an increasing number of women on boards, there are still issues of gender discrimination in terms of promotion or remuneration. However, companies that avoid appointing women in their boards are subject to lower performance as they fail to make use of the social capital offered by females, who have greater capacity in joining collective actions and resolve common problems (Lowndes, 2000). Public policies also became means of improving gender diversity in terms of gender quota. For example, European countries such as Norway, the Netherlands, France or Belgium, etc. introduced a compulsory quota between 30 to 40% of women membership. Other countries such as Denmark, Austria,

Germany, etc. introduced a voluntary quota, trying to raise awareness on the importance of including more women on boards. In terms of legislation, the European Commission (2012) proposed an objective of 40% “of the under-represented sex in non-executive board-member positions in publicly listed companies, with the exception of small and medium enterprises”. This Directive considered 40% as a minimum objective by 2020.

Unfortunately, the objective related to gender equality within board members leads to downturns in corporate performance, as companies gathered young and less experienced board members in order to increase the quota, especially in countries promoting the compulsory quota. For example, Norway requested at the beginning of this century (when women represented approximately 10% of the board) a quota of 40% women in company directors by 2008. In order to comply with the legislation, companies in Norway replaced about one-third of their male director with women. However, turning to inexperienced and sometimes young board members affected the company’s performance (Ahern & Dittmar, 2012).

With a focus on gender equality, corporate governance strategies and public policies often ignore the necessity of age dispersion within the board. Therefore, our paper examines the board diversity impact on performance in terms of gender equality and age diversity, considering age groups defined by decades. Board diversity tends to vary across sectors and therefore we chose to focus on one industry only, specifically the extraction of crude petroleum and natural gas industry and considering different legislation related to corporate governance, we refer to companies within one country, the United Kingdom. As most studies in the board diversity literature focus on gender equality issues, our analysis is filling a gap in terms of the age of board members, emphasising the impact of young directors versus more experienced ones (experience based on their age) on the corporate performance and efficient asset management in generating earnings.

## **2 LITERATURE REVIEW**

The literature developed over time several theories after analysing the impact of gender on board effectiveness and corporate performance. From this point of view, the agency theory, which is concerned by the conflict of interests between managers and shareholders, evidences the fact that women directors have a more active role than men, as they tend to debate more, gather more information by questioning the other board members, exhibiting a more collaborative and ethical behaviour, attending more board meetings than the male members (Bilimoria & Wheeler, 2000; Adams & Ferreira, 2007; Pan & Sparks, 2012; Virtanen, 2012). From this perspective, better board monitoring and firm performance are expected from gender diversity. In addition, female directors tend to have better social networks in terms of diversity, and a better understanding of the market being more creative, analytical and innovative in solving problems (Hillman, Cannella & Harris, 2002; Singh, Terjesen & Vinnicombe, 2008).

The gender role theory considers the differences between men and women and their behavioural influence in terms of communication and influence spread towards others. As long as directors should promote effective communication and influencing tactics on other board members, women tend to be more flexible and better in managing crucial or unclear situations, having more empathy, while men exhibit more assertiveness and self-esteem, which is sometimes detrimental to effectiveness (Eagly, Karau & Makhijani, 1995; Forbes & Milliken, 1999; Rosener, 2011). Similarly, but more developed on the cognitive framework, the Upper echelons theory describes that women directors are able to increase the value of the board through their different experiences and knowledge, as they tend to have more degrees and a varied education than male directors, and have a more diverse background, with no relation to CEO or business experience (Hillman, Cannella & Paetzold, 2000; Singh, Terjesen & Vinnicombe, 2008; Carter

et al., 2010). Based on a more complex experience outside the work environment, women also tend to have a better understanding of the consumers and greater interest in philanthropic or social activities for better community service, promoting corporate social responsibility strategies. Overall, the behavioural and cognitive characteristics of female directors add value to companies and increase their performance.

Despite the previous theories mentioned, and the proven positive impact of women on board and corporate effectiveness, gender quota is still reduced in most companies. In addition, although gender discrimination is against the law, women still encounter barriers towards promotion, as companies do not realise the added value from a broader or more innovative perspective brought by more females on the board (Campbell & Bohdanowicz, 2016).

As theories generally assume that social and human capital can be maximised through a careful selection of board members, age becomes an important factor in determining board diversity. More specifically, selection tends to be based on the experience of the board members, which is usually reflected by higher age. However, sometimes younger board members could promote a more flexible behaviour and a better knowledge of the business environment and potential customers. Therefore, social psychological theories suggest that board diversity, especially in terms of age, could increase the corporate performance but also affect its value by encountering conflicts between directors of different ages and divergent thinking (Murphy & McIntyre, 2007; Carter et al., 2010). Increased diversity in terms of board members' age is more likely to be an advantage for firms in their early stage of economic life cycle, as young members are more aware of the societal needs and more experienced in terms of online businesses. Therefore, it is suggested that board composition should be adjusted to the specific needs, as the companies resources differ in time.

A recent study realised by the Investor Responsibility Research Center Institute (Barrett & Lukomnik, 2017) focused on the companies in the S&P 500 and examined the age diversity of board members by industry, market capitalization, and company age (based on its initial public offering). A low dispersion was found on the average age, which was approximately 62 years old, and more than half of the board members are between their fifties and seventies, but a vast majority of them became directors in their forties or fifties. There was no evidence for significant differences across industries or company size (based on market capitalisation). The most diverse boards (with a deviation of 8 years from the average age of the board members, 62 years) were observed in the Information Technology industry and the least diverse one (with a deviation of 6 years from the average age) in Utilities companies. The tenure might also be an important factor in determining the positive influence of age diversity on corporate performance. For example, an older board member newly appointed might bring a diverse perspective compared to a younger member who has longer tenure.

Based on the Swedish Code of Corporate Governance, Dagsson and Larsson (2011) analysed the relationship between age diversity and corporate performance on a group level (based on age brackets of one decade), and concluded that age diversity positively influences the performance of small companies, as the diversity provided by young board members bring out a valuable perspective to the overall corporate governance, increasing the return on assets and Tobin's Q (performance indicators employed in the analysis). Although it is too early to decide on a certain influence that young board members have on performance, it is obvious that younger directors would offer new and innovative perspectives in a competing business environment, and therefore companies should consider appointing young members in their board in order to increase the value of the company.

The best practices in terms of board diversity and corporate governance are getting more attention from public institutions and companies worldwide. Although their relevance and

influence on the economy and society may differ across countries, board diversity in terms of gender and age should be reflected in the corporate performance, providing economic growth, ethical behaviour, and better social development. As long as diversity is so valuable, and performance may be increased based on board members with a variety of skills, knowledge, and experience, through this study we aim to identify how relevant gender and age diversity among board members is for the UK companies operating in the oil and gas industry, considering that the Financial Reporting Council developed over time new principles and provisions related to corporate governance in the Corporate Governance Code.

### 3 DATA AND METHODOLOGY

The model proposed for observing the impact of board diversity on the performance of companies operating in the extraction of crude petroleum and natural gas industry, with subsidiaries in the United Kingdom, is based on Pearson correlations. The model aims at presenting the relationship between the board members' gender and age and economic profitability over a period of nine years. The data was collected from the Amadeus database and it refers to financial ratios and board members individual characteristics over the period 2006-2014.

The profitability indicator employed in this analysis is the return on assets (ROA), and it was considered along several performance indicators (such as profit margin, return on equity). However, we chose to present the analysis of ROA as this was the most influenced by board characteristics. For these, the analysis considers gender (noMen, noWomen) and six age brackets (26-35, 36-45, 46-55, 56-65, 66-75, above 75). In order to retest the results reliability in terms of the influence of board characteristics on ROA, we also employ a couple of control variables related to financing decisions (gearing ratio, noted gear) and the ability of companies to pay the obligations (solvency ratio, noted solv) in order to observe any relevant changes in the influence on ROA.

The analysis will include two stages: the first one describes the correlations between performance, board diversity proxies and control variables, identifying the highest ones, while the second stage of the analysis will refer to regression results obtained through OLS and stepwise regression models. Comparing the results obtained, we will be able to emphasise the board indicators with the highest impact on the economic performance of the companies. The regression models considered will have the profitability indicator as the dependent variable, and the variable related to board diversity as independent variables. The control variables will be added as a final step of the analysis. Therefore, the general regression model is the following:

$$ROA_{it} = \alpha_i + \beta_1 noMen_{it} + \beta_2 age2635_{it} + \beta_3 age3645_{it} + \beta_4 age4655_{it} + \beta_5 age5665_{it} + \beta_6 age6675_{it} + \beta_7 above75_{it} + \beta_8 gear_{it} + \beta_9 solv_{it} + \varepsilon_{it} \quad (1)$$

$$ROA_{it} = \alpha_i + \beta_1 noWomen_{it} + \beta_2 age2635_{it} + \beta_3 age3645_{it} + \beta_4 age4655_{it} + \beta_5 age5665_{it} + \beta_6 age6675_{it} + \beta_7 above75_{it} + \beta_8 gear_{it} + \beta_9 solv_{it} + \varepsilon_{it} \quad (2)$$

where:  $\alpha_i$  (company involved in the extraction of crude petroleum and natural gas industry,  $i = 1...31$ ) represents the unknown intercept of every firm,  $t$  ( $t = 2006..2014$ ) is the year analysed,  $\beta_s$  are the coefficients for every independent and control variable, and  $\varepsilon_{it}$  is the error term. Two models are considered as there is a significant correlation between the number of men and the number of women in Board and, in order to avoid autocorrelation issues, we employ only one of these variables in the regression model.

## 4 RESULTS

### 4.1 Correlations

The Pearson correlations presented in Table 1 indicate that profitability would be negatively influenced by both, the number of male and female board members. Based on the age of board members, the only positive influence on return on assets would come from members of 36-45 years old, or those above 75. In terms of financing, in oil and gas industry more debt would affect the company performance. In terms of board members and their preference for financial resources, it seems again that only those between 36 and 45 and above 75 years old have different preferences compared to the rest, avoiding rising the liabilities of a company, and preferring more equity. In terms of gender, it seems that more female board members are associated with companies with higher gearing ratios, indicating higher debt in their capital structure. Despite the general consideration of the fact that females tend to be more cautious and risk-averse, this database indicates that oil and gas companies with more women on their board have more liabilities. In the next step of the analysis, regression results will confirm the relevance of these correlations, indicating better the statistical significance of the age groups in board members.

Tab. 1 – Correlations between variables employed in the analysis. Source: own research

	ROA	noMen	noWomen	age2635	age3645	age4655	age5665	age6675	age75	gear	solv
ROA	1										
noMen	-0.2344	1									
noWomen	-0.2504	0.9708	1								
age2635	-0.0531	-0.1069	-0.119	1							
age3645	0.0381	0.3141	0.3276	-0.0031	1						
age4655	-0.2052	0.5763	0.5138	-0.1269	0.1896	1					
age5665	-0.1712	0.4551	0.3759	-0.1039	-0.0573	0.7398	1				
age6675	-0.1689	0.4019	0.3185	-0.1127	0.0134	0.6299	0.9091	1			
age75	0.0123	-0.0824	-0.1026	-0.0479	0.0636	-0.1297	-0.0968	-0.0783	1		
gear	-0.1884	-0.0114	0.053	0.2532	-0.711	-0.0945	-0.1038	-0.1046	-0.1292	1	
solv	0.1562	-0.1687	-0.226	-0.2651	0.0619	-0.0419	-0.0872	-0.0469	0.0175	-0.7855	1

### 4.2 Regression results

We start by considering the board diversity variables and their influence on return on assets (results are presented in Table 2). After considering only the impacts of age and gender on performance, we will add to the model several variables related to financing in order to observe whether the board proxies change their influences on profitability.

Results indicate that both, the number of men and women affect profitability in companies operating in the oil and gas industry. However, more negative impact comes from women, as this regression coefficient is four times larger than the one related to the number of men on board. In terms of the age brackets, the only members who would have the potential to increase performance in these companies are those who are between 36 and 45 and those between 56 and 65. The rest of them carry a negative influence on ROA, as regression results prove. We consider the stepwise regression results the most reliable in our analysis, as it keeps in the model only variables with a statistical significance lower than 20%. Based on the stepwise models we observe from the statistically significant results that members between 36 and 45 years old have a positive influence on corporate performance, while the younger ones or those between 46 and 55 would restrict the profitability of oil and gas companies. The goodness of fit for these models is limited as only up to 10% of the variance in ROA may be explained through the diversity variables considered for this database.

Tab. 2 – Regression results on the impact of board diversity on profitability. Source: own research

	(1) OLS	(2) OLS	(3) Stepwise reg.	(4) Stepwise reg.
<b>noMen</b>	-0.058***		-0.058***	
	(0.019)		(0.019)	
<b>noWomen</b>		-0.221***		-0.217***
		(0.059)		(0.059)
<b>age2635</b>	-4.643*	-5.031*	-4.523	-4.870*
	(2.770)	(2.754)	(2.760)	(2.744)
<b>age3645</b>	1.336**	1.467***	1.300**	1.416**
	(0.556)	(0.554)	(0.552)	(0.550)
<b>age4655</b>	-0.448*	-0.438*	-0.432*	-0.419
	(0.261)	(0.256)	(0.259)	(0.255)
<b>age5665</b>	0.248	0.263	0.244	0.258
	(0.181)	(0.180)	(0.181)	(0.180)
<b>age6675</b>	-0.373	-0.418	-0.370	-0.414
	(0.266)	(0.264)	(0.265)	(0.264)
<b>age75</b>	-2.377	-3.013		
	(3.860)	(3.838)		
<b>Constant</b>	12.22***	12.35***	12.13***	12.23***
	(1.169)	(1.153)	(1.157)	(1.141)
<b>R-squared</b>	0.092	0.107	0.091	0.105

When taking into consideration a couple of control variables related to financing decisions and the level of debt owed by oil and gas companies, results prove that gender and some of the age brackets are relevant in terms of board diversity. The results are included in Table 3. The number of board members who are above 55 years old would not have a statistically significant impact on profitability, and therefore in stepwise regression models the variables age5665, age6675, and age75 were excluded from the model based on their low statistical relevance. We can observe again that the presence of more women in board would affect return on assets to a greater extent than the presence of men. However, it is a common fact that more board members induce a decrease in companies' profitability. While young board members and those between 46 and 55 years old have a negative influence on ROA, results prove once again that the members who would have the potential to increase performance in oil and gas companies from the UK are those who are between 36 and 45. In terms of the financing decisions, it seems that higher debt would affect the economic performance (a negative influence from the gearing ratio towards ROA), while performant companies have sufficient cash flows to meet their short-and long-term liabilities (the solvency ratio has a positive influence on ROA). Even with the control variables considered, the goodness of fit for these models is still reduced: up to 12% of the variance in ROA may be explained through the board diversity, gearing and solvency ratios.

Tab. 3 – Regression with stepwise model on the impact of board diversity on profitability. Source: own research

<b>noMen</b>	-0.050***		-0.064***	
	(0.019)		(0.016)	
<b>noWomen</b>		-0.176***		-0.209***
		(0.058)		(0.059)
<b>age2635</b>				-4.582*
				(2.740)
<b>age3645</b>	0.924*	1.001**	0.921*	1.180**
	(0.502)	(0.503)	(0.513)	(0.508)
<b>age4655</b>	-0.348*	-0.362**		-0.308*
	(0.184)	(0.176)		(0.177)
<b>gear</b>	-0.014***	-0.013***		
	(0.004)	(0.004)		
<b>solv</b>			0.057*	
			(0.032)	
<b>Constant</b>	14.285***	14.234***	8.549***	12.455***
	(1.298)	(1.293)	(1.775)	(1.134)
<b>R-squared</b>	0.114	0.119	0.080	0.097



## 5 CONCLUSIONS

This research yields significant insights into the association between board diversity and profitability, providing an empirical analysis on how gender and age differences across board members influence business profitability in the extraction of crude petroleum and natural gas industry.

The main results indicate that both, the number of men and women affect profitability, and therefore, for oil and gas companies to be more profitable, they are expected to reduce the number of board members. Despite the gender diversity theories which expect increased profitability for companies with more women directors, our research indicates that the negative influence on ROA from the number of women on boards is about four times larger than the negative influence from the number of men on board. Differences were identified in terms of financing as well, as oil and gas companies with more women on their boards have more liabilities, despite the fact that we expected a risk-averse behaviour from women directors. However, in this relationship the tenure of board members should be further analysed as the decision of contracting more debt might have been undertaken when the board composition was different from the one considered in this analysis.

The results also emphasised a positive influence from middle-aged directors (aged between 36 and 45) and, with a low statistical significance level, from more experienced ones (experience based on board member age, of 56-65 years old) on the corporate performance and efficient asset management in generating earnings. In addition, the analysis proved that young board members induce a negative influence on ROA. More specifically, companies that have more board members aged between 26 and 35 are expected to have lower profitability. The same negative influence on ROA was underlined from board members who are between 46 and 55. The rest of the age brackets were not statistically significant for the database considered.

These conclusions could be relevant for the oil and gas sector, which needs diversity of thought and experience in order to mitigate the disruption in the industry caused by the price volatility and environmental legislation. In addition, companies from this industry should work harder in demonstrating the possibilities and career opportunities for women, in order to match their skills. From the theories and the studies presented in the literature review, it was highlighted that board diversity varies across sectors. Therefore, we focused on companies operating in one industry and one country (the United Kingdom) as different legislation related to corporate governance also influences the relationships between corporate governance indicators and performance. As most studies related to board diversity focus on gender equality, our analysis is filling a gap, by also considering the age of board members. Further research should consider how age diversity affects firm performance in other markets or cultures, offering insight into the phases of a business cycle in the companies analysed, and into the tenure of board members.

### Acknowledgement

This work was cofinanced from the European Social Fund through Operational Programme Human Capital 2014-2020, project number POCU/380/6/13/125015 “Development of entrepreneurial skills for doctoral students and postdoctoral researchers in the field of economic sciences”.

## References

- Adams, R. B., & Ferreira, D. (2007). A theory of friendly boards. *Journal of Finance*, 62(1), 217-250. doi: 10.1111/j.1540-6261.2007.01206.x
- Ahern, K. R., & Dittmar, A. (2012). The changing of the Boards: The impact on firm valuation of mandated female board representation. *Quarterly Journal of Economics*, 127(1), 137-197. doi: 10.1093/qje/qjr049
- Barrett, A., & Lukomnik, J. (2017). *Age Diversity within Boards of Directors of the S&P 500 Companies*. Retrieved from <https://corpgov.law.harvard.edu/2017/04/06/age-diversity-within-boards-of-directors-of-the-sp-500-companies/>
- Bilimoria, D., & Wheeler, J. V. (2000). Women Corporate Directors: Current Research and Future Directions. In M. Davidson & R. Burke (Eds.), *Women in Management: Current Research Issues Volume II*. London: Sage. doi: 10.4135/9781446219775.n10
- Campbell, K., & Bohdanowicz, L. (2016). Corporate Governance and the Growing Role of Women in the Boardroom. In M. Aluchna & G. Aras (Eds.), *Transforming Governance: New Values, New Systems in the New Business Environment*. London: Routledge. doi: 10.4324/9781315550107-12
- Carter, D. A., D'Souza, F., Simkins, B. J., & Simpson, W. G. (2010). The gender and ethnic diversity of US boards and board committees and firm financial performance. *Corporate Governance: An International Review*, 18, 396-414. doi: 10.1111/j.1467-8683.2010.00809.x
- Dagsson, S., & Larsson, E. (2011). *How age diversity on the Board of Directors affects Firm Performance*. Karlskrona: Blekinge Institute of Technology, School of Management. Retrieved from <http://www.diva-portal.org/smash/get/diva2:831952/FULLTEXT01.pdf>
- Eagly, A. H., Karau, S. J., & Makhijani, M. G. (1995). Gender and the effectiveness of leaders: A meta-analysis. *Psychological Bulletin*, 117, 125-145. doi: 10.1037/0033-2909.117.1.125
- European Commission. (2012). *Women on Boards: Commission proposes 40% objective*. Retrieved from [https://europa.eu/rapid/press-release\\_IP-12-1205\\_en.htm](https://europa.eu/rapid/press-release_IP-12-1205_en.htm)
- Financial Reporting Council. (2018). *The UK Corporate Governance Code*. Retrieved from <https://www.frc.org.uk/getattachment/88bd8c45-50ea-4841-95b0-d2f4f48069a2/2018-UK-Corporate-Governance-Code-FINAL.PDF>
- Forbes, D. P., & Milliken, F. J. (1999). Cognition and corporate governance: Understanding boards of directors as strategic decision-making groups. *Academy of Management Review*, 24, 489-505. doi: 10.2307/259138
- Hillman, A., Cannella, A., & Paetzold, R. (2000). The resource dependence role of corporate directors: Strategic adaptation of board composition in response to environmental change. *Journal of Management Studies*, 37, 235-255. doi: 10.1111/1467-6486.00179
- Hillman, A., Cannella, A., & Harris, I. (2002). Women and racial minorities in the boardroom: How do directors differ? *Journal of Management*, 28(6), 747-763. doi: 10.1080/09585190701695275
- Lowndes, V. (2000). Women and Social Capital: A Comment on Hall's 'Social Capital in Britain'. *British Journal of Political Science*, 30(3), 533-537. doi: 10.1017/S0007123400210223

- Murphy, M., & McIntyre, M. L. (2007). Board of director performance: a group dynamics perspective. *Corporate Governance: The International Journal of Effective Board Performance*, 7(2), 209-224. doi: 10.1108/14720700710739831
- Pan, Y., & Sparks, J. R. (2012). Predictors, consequence, and measurement of ethical Judgments: review and meta-analysis. *Journal of Business Research*, 65, 84-91. doi: 10.1016/j.jbusres.2011.02.002
- Rosener, J. B. (2011). Ways Women Lead. In P. Werhane & M. Painter-Morland (Eds.), *Leadership, Gender, and Organization*. Dordrecht: Springer. doi: 10.1007/978-90-481-9014-0\_3
- Singh, V., Terjesen, S., & Vinnicombe, S. (2008). Newly appointed directors in the boardroom: How do women and men differ? *European Management Journal*, 26, 48-58. doi: 10.1016/j.emj.2007.10.002
- Virtanen, A. (2012). Women on the boards of listed companies: Evidence from Finland. *Journal of Management and Governance*, 16, 571-579. doi: 10.1007/s10997-014-9307-8

### **Contact information**

#### **Sorana Vatavu, Ph.D.**

Vest University of Timisoara, Faculty of Economics and Business Administration  
Pestalozzi Street 16, Timisoara 300115, Timis, Romania  
E-mail: sorana.vatavu@e-uvt.ro  
ORCID: 0000-0002-7966-3696

doi: 10.7441/dokbat.2019.107

# THE INFLUENCE OF INTERNET MARKETING ON CONSUMER BUYING BEHAVIOUR (GEORGIA'S EXAMPLE)

*Giorgi Zarnadze*

## **Abstract**

The paper shows that the increase of internet users is characterized in high rates in the world and in Georgia as well and it leads the changes in consumer buying behaviour. I have made a research to study how buying behaviour is connected to internet marketing. In the research, it is identified the main tendencies of getting involved in the internet space. It is studied how internet advertising can impacts the buying behaviour. What factors make consumers change their attitude and move from shops to online tools? Also, the research focuses on the connection between buying frequencies and consumer behaviour. In the paper, it is evaluated the level of internet marketing development in Georgia. There are some recommendations for companies on how to improve the internet marketing level and there are some advantages shown after following these recommendations. Finally, the results show the correlation between internet marketing and consumer behaviour.

*Keywords: Internet Marketing, Marketing Research, Online consumer Behaviour, Georgia's Market*

## **1 INTRODUCTION**

The invention of the Internet is considered as the beginning of the information age and the greatest achievement in the history of mankind. It has changed both: communication and business. In business, the Internet has become an interactive channel of interconnection that drives sales online. One of the advantages of internet is that it enables businesses to reach a worldwide customer population so that customers can survey, select, and purchase products and services from businesses around the world (Al Kailani & Kumar, 2011). Social media, as a part of internet marketing, especially social networking sites, provide a virtual space for people to communicate through the Internet, which also might be an important agent of consumer socialization. On the other side customers are central part of all marketing activities. Success and in turn profit is not unthinkable without customers (Dilham, Sofiyah & Muda, 2018). Companies invest millions of dollars to attract consumers and make them loyal to their products or services and creating loyal customers is at the heart of every business (Kotler & Keller, 2016). Nowadays people changed their attitude to shopping and previous markets are partly changed by online platforms. People have different desires and companies should follow them. That's why they are trying to create some online platforms for internet shopping. I tried to connect these two topics to each other: Internet marketing and consumer behaviour. In Georgia there are no researches in this field so I decided to make small research to study the correlation between them.

## **2 THEORETICAL FRAMING**

Electronic and Internet technology have become an integral part of our lives. The digital age offers marketers new exciting ways to get to know consumers and create products and services relevant to their needs. It helps marketers in communicating with a broad range of users as well as establishing individual communication. The rapid development of this new field has given

rise to a new marketing direction - Internet marketing, which involves buying and selling information, services and goods using the Internet.

Internet marketing is recognized as an integral business function and a key that drives a business towards. Internet Marketing is the process of building and maintaining customer relationships through online activities (Heinze, et al., 2017).

It is mentioned that Digital marketing is often referred to as internet marketing, online marketing, or web marketing. The term digital marketing and its impact on people's life increase on the same day by day. Digital marketing is one of the most convenient and effective way of marketing these days and with the development of technology, its technique and scope are also developing (Atshaya & Rungta, 2016).

Some authors informed that another type of marketing orientation that has emerged since the advancement in technology is internet marketing orientation. Regardless of any situations, people often carry their technology devices with them. When they are alone or during their leisure time, people often use laptop or mobile phone in order for them to stay away from boredom (Wen Shien & Yazdanifard, 2014).

The internet has transformed marketing today and that means new possibilities, advantages and peculiarities. Nowadays the concept of internet marketing has expanded and includes more opportunities to stay close to the consumer. In fact, internet marketing solves the same tasks as marketing; it simply uses the advantages and tools that the internet provides. No matter the size of the business, using the Internet in all cases is promising and advantageous (Bhatia, 2017).

Consumer buying behaviour is defined as the mental, emotional and physical activities that people engage when selecting, purchasing using and disposing of products and services in order to satisfy need and desires (Schiffman & Wisenblit, 2019). According to these authors, consumer behaviour is affected by many factors, such as income level, price, elasticity, substitute goods. But in modern theories they also focus on advertising as a part of internet marketing activity.

In January 2019, global media agent "We Are Social" has published reports that more than four billion people (4.388) use the Internet worldwide. Comparing to the last year it means 367 million users more, 9.1 percent growth. Despite the fact, there are few internet users in central Africa and middle Asia the tendency of growth can be seen. Clearly, people are exposing themselves to more and more digital and social media. This is for many purposes, including in their roles as consumers and also to communicate with others (Global Digital Report 2019, 2019).

According to the Georgian National Communications Commission, more than half a million people (645 104) could use the internet, comparing to the last year it means 81 738 more users. There are five main companies that share all those clients. Since 2010 the increase is half a million and regarding mobile internet, the increase is almost two million. All those numbers have changed the value of costumers for the businesses and it means more enrolment in internet marketing. Because of these factors, companies try to collect more information about their customers, so that's why the study of customer behaviour is so important (Sivasankaran, 2017). Market and consumer behaviour separately research is also being conducted in Georgia. Characteristics of user behaviour are studied. These studies are mainly focused on costumers' attitude on different brands. Studies on the behaviour of Georgian consumers towards internet marketing are quite scarce, which requires proper processing. I conducted marketing research aimed at the consumers of Georgian internet market identifying behavioural features and identifying key factors affecting them (Georgian National Communications Commission, 2018).

### **3 THE METHODOLOGY OF THE RESEARCH**

For collecting primary data online survey was used. Five-level Likert scale was used as an approach to scaling responses in the survey and regarding sampling techniques the non-probability technique was applied. I choose quota sampling as the sample could be controlled for certain characteristics. The sample size was chosen according to the table of (Gill & Johnson, 2010). The confidence level was 95%, margin of error 5, variance of the population 50%, population size 500 000, so according to the table (Gill & Johnson, 2010) the sample size was conducted – 384. The respondents were mostly from 18-45 years old, employed with average income level as they are able to use online shopping service, located in the capital, as their accessibility to internet and online shopping was high. Those were the main criteria for how these respondents were selected.

### **4 THE RESULTS OF THE RESEARCH**

The research has shown that there is an equal interest in internet shopping between men and women. There were participants from all age groups in this survey but the leading group was 18-25 (54.96%), then 26-35 with 31.25% and the last one was 35-45 group with 13.79%. the percentages show how are they involved in online shopping.

In order for the respondents to gradually become aware of the issues, the first phase of the survey mainly focused on engaging the user on the Internet. The survey found that the majority (83.33%) of respondents are active users of the internet, and most of them spend more than 3 hours a day on the internet. More specifically: 28.38% of respondents spend 3-4 hours a day, 26.56% spend 5-7 hours and 23.95% more than 7 hours. There are just 21.11% of respondents who spend less than 3 hours on the internet a day. These results allow us to analyse how important is the internet in Georgians life. For the majority of the population, information seeking is the priority (44.27%), the second place is occupied by social networks by 41.92% and professional needs 13.81%.

On the next stage respondent's attitudes toward internet marketing were revealed, in fact, their experiences and memories that are connected to online shopping. It was found that 21.11% of respondents use online shopping even though the same good or service is available at the company's offices, 31.77% prefers to buy the product or service at a place where these are offered to people, but sometimes they still use the internet shopping, there is just 22.13% of respondents who never use online shopping and they don't trust these kinds of sales and 25% feel discomfort while using online shopping but sometimes they still use it.

Regarding the change in the consumer behaviour of the respondents, 33% of the respondents think that the using of the internet has allowed them to save a lot of time and energy, which in turn has saved them money. The buying process has been streamlined. 39% of respondents think that when comparing competing products, they could find more information about it so they feel more informed, obviously, this does not mean that they will make a purchase online. For 21% internet didn't impact their behaviour, and there was just 7% who had a negative experience with online shopping. This research proofs that customers are ready to make online purchases again if the previous experience was positive, they are totally ready to apply for the same companies.

In the research process, it was really interesting what factors influenced consumers while making their decisions, most of the respondents (37%) mentioned that information is the most important thing for them, that means when making a decision it is important for them to have the accurate and relevant information. Most of the respondents complained that Georgian companies do not provide proper information about their product. That was an explanation why

there is such a low level of trust to them. The respondents also reported availability (32%) and simplicity (31%).

This marketing research shows that 51.5% of respondents have a positive attitude towards internet advertising. According to the research, the main reason for their positive attitude is that they receive information through internet advertising about news and products. 27.34% of respondents have a neutral attitude towards internet advertising and 21.35% have a negative attitude. The main reason for the negative attitude as the majority of the respondents stresses that advertising prevents them from watching or listening to movies, news, programs and others. 62.5% of respondents said that online advertising influenced their decision to buy. However, it is interesting to note that the level of exposure to Internet advertising is higher among employed people. Respondents who are not influenced by internet advertising (37.5%) say that they do not trust the information posted on the internet at all.

Consumer attitude towards Georgian and foreign internet companies is very important. It was found that the majority of users (55%) use both Georgian and foreign websites. Only 35% of respondents trust foreign websites, and only 10% trust Georgian websites, which is a low indicator of trust in local companies. 27% of respondents think that internet marketing is well-developed in Georgia, 18% don't have the information about that and 13% think that internet marketing is not developed at all in Georgia. 42% of respondents think that internet marketing in Georgia is still in the developing process. According to this question, we can also understand the attitude of consumers to activities that companies do, that all means the companies employed on Georgian market still have pretty much development potential.

It seems that marketing campaigns carried out by Georgian companies are distrusting consumers. Therefore, it is interesting to determine the extent to which their actions need to be improved when it comes to online marketing activities. 21% of respondents believe that companies should offer more intense offers to consumers, which means expanding online shopping and advertising channels and therefore offering more comfort to the target audience. 38% of respondents think that companies should make higher-quality offers, while 35% think that when using a particular product, the Internet should be more convenient for consumers. Only 6% of the respondents do not think that Georgian companies need any improvement in this direction.

The survey also dealt with identifying sources of information on internet marketing. I was interested in what tools consumers use to get information about their desired goods or services. Majority of respondents (57%) mainly are informed by the Internet, as well as by the television (21%) and radio (11%). The share of magazines (5%), banners (4%) and other media (2%) is quite low. When choosing the right company, most of the respondents (34%) are influenced by relatives and friends as well as past experience (29%) and advertising (17%). 20% of respondents are not aware of the influence of information sources.

It was quite interesting to see how online purchasing of goods and services cause associations with consumers. 28% of respondents think that they are informed in the shortest time, which makes it easier for them to make a decision. 25% think the Internet is undoubtedly useful, but it can only help with certain goods and services purchases. According to 24% of consumers, the information received on the Internet is more tempting and exaggerated than the actual one, which points to wrong marketing calculations by companies. Clearly, selling your own products is a prerogative of any organization, however, this should not be at the expense of misleading and deceiving customers. Advertisements on the website must match their actual characteristics. It should be noted that 23% of respondents do not pay any attention to this kind of information.

In assessing the quality of internet marketing activities conducted by Georgian companies, 41% of respondents said it was average and 33% indicated it was low. Only 9% of respondents consider the level of internet marketing in Georgia to be high quality, and 17% find it difficult to answer. However, consumers are ready to give up on online shopping if the goods or services do not meet their expectations.

Research shows that consumers prefer foreign sites when purchasing products, while services are mainly provided by Georgian sites. All of this points to the relatively high development of internet marketing in Georgian companies employed in the field of services, but it is also noteworthy that Georgian companies' quality of internet marketing is lower than average according to the respondents.

## 5 CONCLUSION

This marketing research shows that Georgian consumers consume electronics tools in their daily lives. It is also obvious that the level of internet marketing is still very low in the country and although majority of population have access to internet there are still some people without it. The results show that the most important factor that can change consumer behaviour is information. This is the reason for low level of trust to Georgian companies as the respondents mention the information provided by Georgian companies is wrong in most cases. So here comes the number one task for them. According to the results, if Georgian companies provide correct information about their product they can increase internet sales. These are the results that should become a factor for more active internet marketing activities for companies employed in the Georgian market. According to the research, the user is dependent on the internet when trying to find any information. However, consumers are not completely positive about online shopping, so they express mistrust towards companies, but the majority mentions that online advertising made them buy product. This is also one of the problems in Georgia. Georgian companies should provide proper online advertising that will also help them to increase their income level. Namely, some respondents prefer to buy the desired goods or services at a store, while others see some risks in the process of online shopping, but they still apply it. Providing more information about the products they want will increase their trust in companies.

### References

- Al Kailani, M., & Kumar, R. (2011). Investigating Uncertainty Avoidance and Perceived Risk for Impacting Internet Buying: A Study in Three National Cultures. *International Journal of Business and Management*, 6(5), 76-92. doi: 10.5539/ijbm.v6n5p76
- Atshaya, S., & Rungta, S. (2016). Digital Marketing VS Internet Marketing: A Detailed Study. *International Journal of Novel Research in Marketing Management and Economics*, 3(1), 29-33. Retrieved from <http://www.noveltyjournals.com/journal/IJNRMME/Issue-1-January-2016-April-2016/0>
- Bhatia, P. (2017). *Fundamentals of Digital Marketing*. New Delhi: Pearson.
- Dilham, A, Sofiyah, F. R., & Muda, I. (2018). The internet marketing effect on the customer loyalty level with brand awareness as intervening variables. *International Journal of Civil Engineering and Technology*, 9(9), 681-695. Retrieved from [http://www.iaeme.com/MasterAdmin/UploadFolder/IJCIET\\_09\\_09\\_065/IJCIET\\_09\\_09\\_065.pdf](http://www.iaeme.com/MasterAdmin/UploadFolder/IJCIET_09_09_065/IJCIET_09_09_065.pdf)
- Georgian National Communications Commission. (2018). Retrieved from [www.gncc.ge](http://www.gncc.ge)



- Gill, J., & Johnson, P. (2010). *Research Methods for Managers*. London: Sage.
- Global Digital Report 2019. (2019). *We Are Social*. Retrieved from <https://wearesocial.com/global-digital-report-2019>
- Heinze, A., Rashid, T., Fletcher, G., & Cruz, A. (2017). *Digital and Social Media Marketing: A Results-driven Approach*. Routledge: Taylor & Francis.
- Kotler, P., & Keller, K. L. (2016). *Marketing management*. London: Pearson.
- Schiffman, L. G., & Wisenblit, J. (2019). *Consumer Behaviour*. London: Pearson.
- Wen Shien, L., & Yazdanifard, R. (2014). Relationship Marketing Vs. Internet Marketing: Which one Contribute to Gain Higher Level of Consumer Loyalty. *Global Journal of Management And Business Research*, 14(7), 41-47. Retrieved from <https://journalofbusiness.org/index.php/GJMBR/article/view/1567>

### **Contact information**

#### **Giorgi Zarnadze**

Tomas Bata University in Zlín, Faculty of Management and Economics  
Mostní 5139, 760 01 Zlín, Czech Republic  
E-mail: [zarnadze@utb.cz](mailto:zarnadze@utb.cz)  
ORCID: 0000-0003-1664-1278

doi: 10.7441/dokbat.2019.108

# DETERMINATION OF OPTIMAL CROP PRODUCTION IN MAIZE REGION OF SLOVAK REPUBLIC, UNDER CONDITIONS OF UNCERTAINTY

*Martina Zaujecová, Jozef Repiský*

## Abstract

In this document are solved issues of decision-making, process in case of solving difficult problems and to determine the most suitable alternatives for personal benefits. This document is focused on conflict situations with several participants. These situations we can call by the term from the theory of games as a game with nature. Our intention was to use model, which is typical for games in conditions of uncertainty, where the only opponent of every single subject is the nature with its random effects. This document is oriented to achieve the highest level of profit with combination of growing more types of plants and doesn't matter how the nature was behaving. Slovak territory is diversified and therefore split into several agricultural subcategories. To assure that results of the analysis are reliable as much as possible, we choose one area with more narrow characteristics. We paid attention to corn area of Slovak Republic. The main goal is to identify optimal structure of crop production in the selected area. maximization of the benefits by using the apparatus of game theories and take a statement on the impact of subventions to determine the optimal plan of plant production and obtained benefits. It means Wald model, Savage model and Agrawal - Heady principle, which are based especially for linear programming. Using these models, we can interpret also the impact of a possible deviation from the recommended strategy through shadow price and reduces cost. Based on our research, we can conclude that wheat should occupy only little more than  $\frac{1}{4}$  of the soil. Corn grain around 16.6%, barley 12% and sunflower 10%. Rest of crop should occupy less than 10%. Growing of oats, peas, grape and other cereals is considered as ineffective. Subsidies do not have big impact on the definition of optimal sowing plan.

*Keywords: decision-making, seeding plan, subvention, profit*

## 1 INTRODUCTION

Producers, which are on competitive market, are looking for possibilities to maximize profit by growing of yield from range (Bezat-Jarzębowska and Rembisz, 2013). Increasing of production contributes to economic growth and thereby to growth of overall economic prosperity. However, in most markets with high GDP per inhabitant, the rate of growth of production in the sector is determined by an increase of low demand. According to Fiegiel and Remimbisz (2013), research confirms that the increase of demand for agri-products that occurs in a certain period also determines the growth of production in agri-food sector. A low rate of growth in demand for agricultural products can limit growth in the agri-food sector. Therefore, must be determined a change in efficiency-based relationships, which is considered as the main growth factor in this sector. The authors suppose that the growth of inputs is not main factor of competitiveness, but the efficiency of using these inputs is the major factor of competitiveness, which is expressed by ability of long-term efficient growth and by performance.

The key to efficiency of the production is the ability of management to respond to new market conditions, objective analysis and evaluation of own possibilities and own results. Also making the right decisions is very important. Identification of an optimal production structure is one of the key issues. Successful solution of these issues is conditional on the economic performance

of agricultural business entities. For objectification of solution in case of complex problems solving, various support systems and related information systems are available nowadays. McCown (2002) describes in his publication the development of these systems. Different researches and managers from different areas have changed their way of thinking due to the development of information technologies. He recommends more studying of own history and own roots, which will provide fewer problems and greater success. The knowledge obtained this way, can be still useful for understanding past problems and for reassessing which agricultural models of information systems could be more useful for managing the agricultural plants. Dantzig (1951) mentions in his study a theoretical game model, which can be used to solve problems in the field of agriculture as well. The model with one criterion is often unsatisfactory and cannot capture the reality of decision making in the theoretical game model. Therefore, is appropriate to use a mix of multiple criteria, like maximizing of the minimum value, minimizing of the greatest loss and maximizing of the minimum batch as Romero and Rehman (2006) are mentioning. For agricultural decision-making models, the most used criterion is maxi-min Wald, mini-max Savage and Agrawal-Heady, which represents a compromise between the previous two.

The article is focused on decision-making in indefinite conditions and on finding an optimal strategy. The optimal strategy in agriculture represents commodity ratio that can ensure efficiency of using the sources and maximal benefit. Opponent of these model games is nature, which creates conditions of indeterminacy. These conditions consist from the fact, that we do not know the probability of behaviour of nature.

## **2 THEORETICAL BACKGROUND**

Decision-making represents three main basic concepts. Decision-making problem, decision-making process and process of selection. Decision-making problem is deviation of the actual status from the expected status. Natural, there must be an undesirable difference where the actual status is worse than expected status. Problems can be divided into a potential and real. Decision-making process is process of solving decision-making problems, it means problems with several possible (at least two) options. The decision-making process is consisting of several follow-up sub processes, running in certain time sequence, using resources and aiming to achieve the set target. Basically all steps to reach expected status (Grasseová, 2013).

Rational decision-making is the basis for the success of game theories. All its reasons are based on reasonable (computational or deductive) operations (Démuth, 2013). Hrablík-Chovanová (2014) is highlighting heuristic approach. It combine several methods, from the decision tables to analyses. According Repiský (2008), elements of the decision-making process are: (a) objective – expected future status of system, reached by implementation of appropriate solution. It could be determined quantitatively or qualitatively. This element is the most important part of decision-making, because it's basic stimulus. It should be set clearly, comprehensibly and achievement must be done in defined time frame; (b) decision-making criteria – these criteria are used for determination of the most appropriate and less appropriate ways of solution. The criteria are based on the defined objective; (c) decision-making problem – this problem occurs when current status may be better than it is; (d) decision-making subject – person (individual subject) or group of people (collective subject) who make decision and selection of appropriate option depends on them; (e) decision-making object – part of objective reality in which the problem is formulated and target set; (f) decision-making options – represent possible ways of solving the decision-making problem, which should lead to the expected future status or reach previously defined target; (g) consequence of option – represents the status of the object after implementation of chosen variant; (h) world status – one-dimensional or multidimensional

discrete random variables, that affect the decision-making subject and the consequences of variants; (i) risk factors – accidental influences, the change of which affects positively or negatively the consequence of variants; and (j) decision-making principles – rules, according to which we can determine the most appropriate solution, taking into account in whole or partially, the impacts of individual solutions.

Optimal decision is particular variant, selected from the set of all variants. In case of unchanged conditions is most profitable for player. Mathematician John Nash has been focused in game theory for long years. Thanks to that, he get the Nobel Price. Hungarian mathematician John von Neumann was trying to scientifically justify cheating in poker game. Thanks to that, he combined previous inductions of several mathematicians a built a base for new applied science – game theory. Game theory is mentioned as a scientific discipline. It should include operational analysis and one of the fields of applied mathematics. Using the game theory, we can crate model and solve conflict situations, which are representing a conflict of human interests, interests of groups or some organizations (Goga, 2013).

Basic terms in game theory (Goga, 2013): (a) game – it should represent set of restrictions and rules, it is a conflict, which can be presented using mathematical model; (b) actor – is agent or decision-making subject, actively involved in game. It means natural or legal person or nature; (c) strategy – represents a way how player can act during the game. Player has more choices how to behave – more strategies; and (d) payment – numerically presented result in the end of the game. The win is shown in plus and loss in minus. There may be situation when profit is not worth to any player, because result is 0. In games also nature can act in the role of teammate. These are the games played with nature, mostly in agricultural units.

Nature, like every player, has its own behaviour. It is expressed by the weather that can occur, by the action of pests, insects, animal diseases, natural disasters and other conditions that we may not even know. Because of this fact, nature creates a risk or uncertain conditions in the game.

Uncertainty-based decision making based on statement of Démuth (2013), represents the lack of knowledge of the exact distribution of probabilities of obtain wins or losses. Also, the possibility of irrelevance of the layout. In this situation, we are trying to maximize our chance of win, or at least reduce the riskiness that the situation gives. In many cases, we are facing problems and decision-making with not the low level of uncertainty, where some of our selections can have irreversible consequences. Unfortunately, especially in medicine, law or science.

In the presented document, decision-making represents searching of an optimal solution. The optimal solution is an optimal crop plan in the corn region of the Slovak republic. We are identifying it by using the game theory apparat, under conditions of uncertainty. Uncertainty is created by nature as an opponent of the decision-maker. The target is maximal profit under the set restrictive conditions. Restrictions are based on animal production and the market. The decision-making subject has the possibility to choose from several decision criteria and choose a suitable strategy based on his / her beliefs.

The area of Slovak republic is located in a moderate climate zone, but it can be divided into several other parts for various physical-geographical factors and also according to the individual crops for cultivation. The Slovak republic area can be divided into five basic areas. Now the corn area is the most extensive. There are the Danube Lowland and the Eastern Lowland, where the crops are grown to an altitude of 200 meters above sea level. Average temperature during year is from 9.5 to 10.5 °C. Every year about 550-600 mm of rain falls on the soil. Typical for this area is black earth, which is the most fertile. Because of these properties, it is the most suitable agricultural area.

### 3 METHODOLOGY

The aim of the article is to identify an optimal strategy in determining of the appropriate production structure in the corn region of the Slovak Republic under condition of uncertainty and comparison of the obtained results without subsidies and with taking into account the subsidies. Corn region is the best area for cultivation of crops because of its conditions. The solution is applied in the theory of games, namely matrix games with nature, using the criteria of the Wald and the Agrawal-Heady.

The Wald criterion ensures the greatest minimum of benefit, regardless of the state of nature. The optimal decision of an intelligent participant in a game is given by a combination of its individual strategies, for which the median of winning or benefits, expressed by formula:

$$\min (x_1a_{1j} + x_2a_{2j} + \dots + x_ma_{mj}) \quad (\text{for } j = 1, 2, \dots, n) \quad (1)$$

Obtains the maximum value and no matter what strategy nature chooses. Here:  $a_{ij}$  ( $i = 1, 2, \dots, m$ ;  $j = 1, 2, \dots, n$ ) represents benefits (profit per hectare) for the intelligent participant of the game in case of the selection of the  $i$ -th strategy and the occurrence of  $j$ -th status of nature elements  $x_1, x_2, \dots, x_m$ , for which is valid:

$$0 \leq x_i \leq 1 \quad \sum_{i=1}^m x_i = 1 \quad (2)$$

Indicates frequency with which an intelligent participant can choose individual strategies  $A_1, A_2, \dots, A_m$ .

Base of the Savage criterion is the principle of mini maximal loss. The optimal decision of intelligent participant will be decision, which protect him from big losses, compared to the decision, which he will made if he knew pure nature strategies. The basis is modified payment matrix, a matrix of losses, which represents loss over the best option in the actual nature status (in the actual year)

$$S = (s_{ij})_m^n \quad (3)$$

with elements:

$$s_{ij} = \max_k a_{kj} - a_{ij} \quad (k \in \{1, 2, \dots, m\}; j = 1, 2, \dots, n) \quad (4)$$

Elements of matrix  $S$  are indicating the amount of loss, which intelligent participant will suffer, if he choose  $i$ -th strategy compared to his best choice, in supposition that he know the nature behaviour in advance. An optimal strategy is the strategy where the median of the win expressed by formula:

$$\max_j (x_1s_{1j} + x_2s_{2j} + \dots + x_ms_{mj}) \quad (\text{for } j = 1, 2, \dots, n) \quad (5)$$

obtains the minimal value.

The Agrawal-Heady criterion is based on the principle of maximization of minimal profit. Beneficial decision is decision which ensure for intelligent participant maximal profit against worst decision, which he will made if he knew the nature behaviour in advance, so the pure strategies. The basis is the calculation of the profit matrix. Elements of this matrix we obtain by the following: In each column of matrix, we deduct the minimum element from all elements of this column. Therefore, we define a new matrix:

$$Z = (z_{ij})_m^n \quad (6)$$

with elements:

$$z_{ij} = a_{ij} - \min_k a_{kj} \quad (k \in \{1, 2, \dots, m\}; j = 1, 2, \dots, n) \quad (7)$$

Elements of matrix Z are indicating the amount of a profit, which intelligent participant will get, if he choose i-th strategy compared to his worst choice, in supposition that he know the nature behaviour in advance. An optimal strategy is the strategy where the median of the win expressed by formula:

$$\min_j (x_1Z_{1j} + x_2Z_{2j} + \dots + x_mZ_{mj}) \quad (\text{for } j = 1, 2, \dots, n) \quad (8)$$

obtains the maximal value.

Optimal strategies are identified by using the linear programming model. For model solution, MS Excel is used. Part of MS Excel is program “Solver”, which identifies optimal strategies. Data for research are obtained from publications of own costs and performance results of agricultural plants in Slovak Republic in years 2006-2014 for corn region, published by Slovak Research institute of agricultural and agri-food economics (VÚEPP) and Ministry of agriculture and rural development of the Slovak Republic (MPRVSR). As there appears problem with uniform availability of input data for each crop, it was only possible to made analysis until 2014.

## 4 RESULTS

Results consist from interpretation of obtained results, which are focused on appropriate crop sowing structure of each crop and on information resulting from potential changes in the restrictive conditions of individual crops in the corn production region. Because of space constraint, highlighted will be interpretations of commodities, which would bring the greatest changes by departing from optimal percentage representation.

Input data correspond to years 2006 and 2014, which are reflecting the gross profits of commodities for 1 hectare.

Tab. 1 – Gross profits of selected crops in years 2006 - 2014 in EUR. Source: VÚEPP (2019), MPRVSR (2014)

REVENUE-VARIABLE COSTS	2006	2007	2008	2009	2010	2011	2012	2013	2014
wheat	109,54	329,91	201,92	-119,81	123,90	213,52	236,90	138,30	189,68
barley	165,34	313,62	224,09	16,26	4,58	310,86	182,01	124,04	138,50
oat	187,01	129,82	-25,49	-96,18	-205,37	46,18	64,93	257,94	8,21
corn for grain	183,83	177,02	181,07	51,46	119,26	491,86	493,86	129,62	171,32
other crops	360,32	667,70	702,38	-58,19	-45,78	-38,47	280,65	350,54	320,87
edible peas	-0,66	61,74	9,00	-228,92	-141,80	146,41	-365,22	-157,49	-84,62
corn for green	32,00	-30,74	-12,75	-126,81	-82,80	-240,48	-137,10	-203,20	-10,45
other one-year feed	97,46	-11,95	-41,46	-32,24	-190,14	-123,72	-9,97	304,56	20,52
multi-annual feed	70,27	61,11	12,85	24,74	4,93	-133,32	-3,60	14,21	59,30
permanent grassland	24,43	-16,03	-54,64	-0,13	-0,06	-33,03	-24,59	-25,75	-16,23
pasture lands	-14,89	-9,25	-6,97	-15,24	-11,24	-3,90	-7,81	-14,22	-15,26
oil-seed rape	256,92	81,79	524,83	-97,97	71,71	406,80	-20,45	431,52	266,67
sugar rape	992,70	722,47	761,00	1165,66	716,80	1558,11	-760,33	-497,76	992,86
grape	-773,09	-860,52	-1131,05	-1487,94	-1589,62	2046,81	87,72	1825,06	330,72
sunflower	27,52	288,12	136,79	-159,98	220,81	378,91	376,00	244,77	35,00

The structural variables of the model represent selected crops of chosen agricultural region. From table 1 is visible which commodities are involved. In the model are expressed only as variables x1 (wheat) - x15(sunflower). Profit respectively loss; reflect the difference of

revenues for 1 hectare and variable costs for 1 hectare of chosen crops without taking into account the subsidies. To comparison, model was also quantified with data including subsidies.

When the Wald criterion is applied on data, linear programming model consist of a function which is representing maximizing of the price of game  $v$  ( $\max v$ ), taking into account the limiting conditions, which ensure that the expected hectare profit is (respecting the nature status in monitored years) bigger or minimally the same as the price of the game. For illustration, here you can see how the model for non-subsidized data looks like. We are taking into account Tab.1.

$$\mathbf{2006:} 109,54x_1 + 165,34x_2 + 187,01x_3 + 183,83x_4 + 360,32x_5 - 0,66x_6 + 32x_7 + 97,46x_8 + 70,27x_9 + 24,43x_{10} - 14,89x_{11} + 256,92x_{12} + 992,7x_{13} - 773,09x_{14} + 27,52x_{15} \geq v$$

$$\mathbf{2014:} 189,68x_1 + 138,5x_2 + 8,21x_3 + 171,32x_4 + 320,87x_5 + 84,62x_6 - 10,45x_7 + 20,52x_8 + 59,3x_9 - 16,23x_{10} - 15,26x_{11} + 266,67x_{12} + 992,86x_{13} + 330,72x_{14} + 35x_{15} \geq v$$

Similar for years 2007-2013.

$$\sum_{i=1}^{15} x_i = 1 \qquad x_i \geq 0 \qquad v - \text{free variable}$$

For the more realistic results, which correspond to requirements of animal production, principles of crop plans and to the sales possibilities, the additional restrictive conditions were added to basic restrictive conditions.

Wheat must be planted at least on 28.6% of field, barley should occupy 13% of field or more, oat cannot exceed 0.1% of the total area, corn (for grain) should be sown on maximum 16.6% of field, other grain should occupy a maximum 0.9%, corn (for green) is necessary to have at least on 6.3% of field, other one-year feed can be sown at least on 0.6%, multi-annual feed can't exceed 8.5%, permanent grassland at least 2.1%, lower limit for pasture lands is 1.5%, oil-seed rape should have a minimum percentage of 8.9%, sugar rape may be maximum 5.5% and sunflower should occupy at least 10% of the area.

Tab. 2 – Gross profits of selected crops in years 2006 - 2014 in EUR. Source: VÚEPP (2019), MPRVSR (2014)

REVENUE-VARIABLE COSTS	2006	2007	2008	2009	2010	2011	2012	2013	2014
wheat	163,08	404,90	264,22	-38,40	237,90	350,11	383,49	296,04	379,98
barley	211,48	377,18	291,74	86,88	94,03	426,80	304,96	260,15	309,32
oat	190,70	144,29	7,07	-64,25	297,39	228,72	160,93	364,51	119,02
corn for grain	247,73	230,50	233,88	203,03	245,31	649,42	685,24	293,29	338,75
other crops	456,05	744,34	784,64	15,09	66,22	63,53	384,65	470,54	430,87
edible peas	19,19	94,04	43,25	-202,28	-27,80	283,00	-218,63	0,25	-1,12
corn for green	33,46	-26,85	-10,29	-126,81	-18,62	-152,01	-90,43	-115,47	80,55
other one-year feed	99,28	-11,95	-41,46	-30,49	-137,27	-84,46	61,07	357,65	92,28
multi-annual feed	72,13	63,27	15,04	69,10	53,02	-63,46	15,63	75,34	84,00
permanent grassland	25,99	-12,75	-51,88	6,00	4,07	4,79	10,43	13,89	0,07
pasture lands	-12,31	-7,64	-6,97	-15,16	15,53	40,40	6,88	-9,96	1,35
oil-seed rape	330,84	154,68	666,27	20,61	208,00	572,02	167,90	614,70	514,80
sugar rape	1152,06	828,29	1374,81	1353,18	1812,35	2064,72	1244,47	2003,28	1737,69
grape	-655,08	-752,24	-935,54	-1253,30	-1277,67	2352,03	392,01	2090,87	582,00
sunflower	78,90	403,01	214,43	-57,38	370,53	545,37	556,36	437,46	226,07

The model for determination of both optimal crop production strategies with and without subsidies looks similar. Only the coefficients taken from Tab.2 are changed. The constraints in the model remain unchanged.

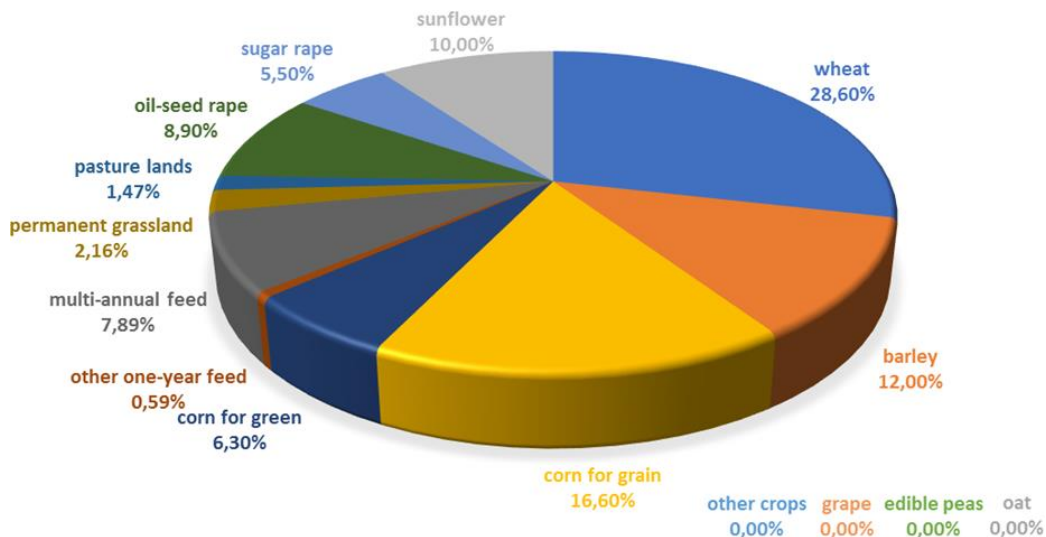

Fig. 1 – The optimal strategy for crop production without subsidies, Wald’s criterion. Source: own research

By using Wald criterion, in corn area, if we don’t consider subsidies, it is not advisable to occupy the area by oats, other crops, edible peas or grape. If in the model is included rye, it can be assumed that rye will not get to sowing plan, because of its weak economic stability. Taking into account possible limitations and requirements, on the largest field should be wheat (28.6%), corn for grain (16.6%), barley (12%) and sunflower (10%). Oil-seed rape should be sown on the 8.9% of area, multi-annual feed on 7.89%. Corn for green is recommended to sown on 6.3% of area, sugar rape on 5.5 %, permanent grass on 2.16%, pasture lands on 1.47% and around on 0.6% would be appropriate to sown other one-year feed. If we are not taking into account state support, with the Wald criterion and by the optimal production structure in the Slovak Republic will be achieved profit 9.17 EUR per 1 hectare. With the Wald criterion based on dual prices was found, that the bigger increase of expected profit by 1% of overall area will be because of sugar rape, namely by 11.41 EUR. EUR. ha<sup>-1</sup> in addition, the biggest decrease because of sunflowers for seed, namely by 1.85 EUR. EUR. ha<sup>-1</sup>. From the reduced costs it can be assumed that if grape (which not reached this model in corn region) will be grown on 1% of field, the expected profit would decrease by 15.13 EUR. ha<sup>-1</sup>. Other crops would also bring a negative change to the expected profit, as it could decrease 0.83 EUR. ha<sup>-1</sup>. Due to the limitation of the scope, we are presenting crop values that cause biggest and smallest change in the expected maximal profit.

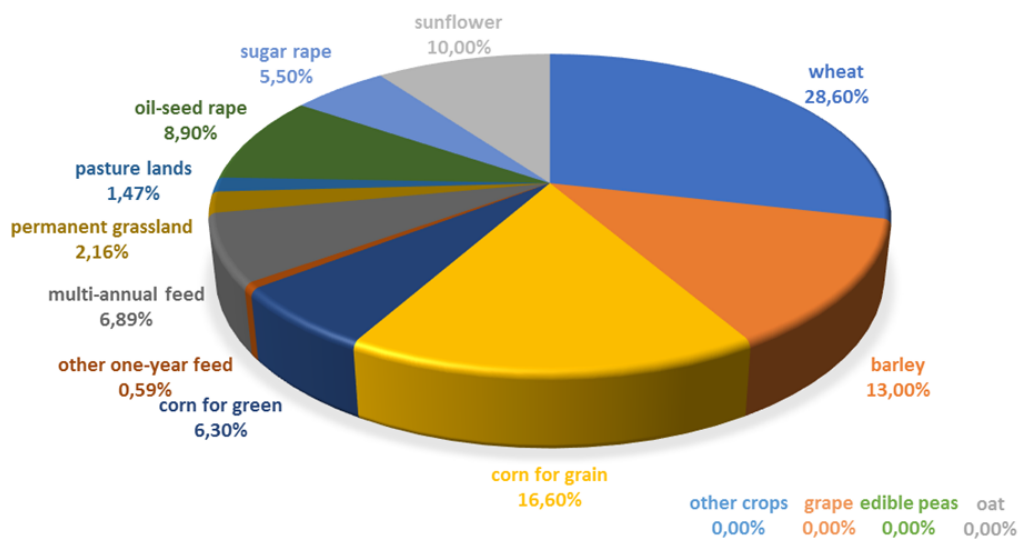

Fig. 2 – The optimal strategy for crop production with subsidies, Wald’s criterion. Source: own research



Taking into account the subsidies, using the Wald criterion, on Fig. 2 we can see, that the optimal sowing plan is same as in the previous model, when we did not take into account subsidies. Change appears only in case of two crops - barley and multiannual feed. The difference is 1%. With subsidies is worth to increase the area for barley, but in case multiannual feed, area should be decreased by mentioned %.

In Slovak corn region, the optimal sowing plan would achieve expected maximum profit 101.03 EUR. ha<sup>-1</sup> by using the first criterion, taking into account subsidies. On the basis of dual pricing, the biggest impact on the expected profit would have an increase of 1% in the area of sugar rape, which would bring an increase of expected profit by 12.84 EUR. ha<sup>-1</sup>, but an additional 1% of the area of corn for green causes a decrease by 1.96 EUR. ha<sup>-1</sup>. From the reduced costs it can be assumed that if grape (which not reached this model in corn region) will be grown on 1% of field, the expected profit would decrease by 13.22 EUR. ha<sup>-1</sup>. Other crops would also bring a negative change to the expected profit, as it could decrease 0.54 EUR. ha<sup>-1</sup>.

Also, with the following results, based on all criteria, is true that if crops which are not in optimal solution, will be in sowing plan, there would be a worsening of the purpose function, that represents in the Wald criterion expected maximal profit, in the Savage criterion minimal loss over the best variant and in the Agrawal-Headey criterion maximal profit over the worst variant, which should happen in conditions of uncertainty.

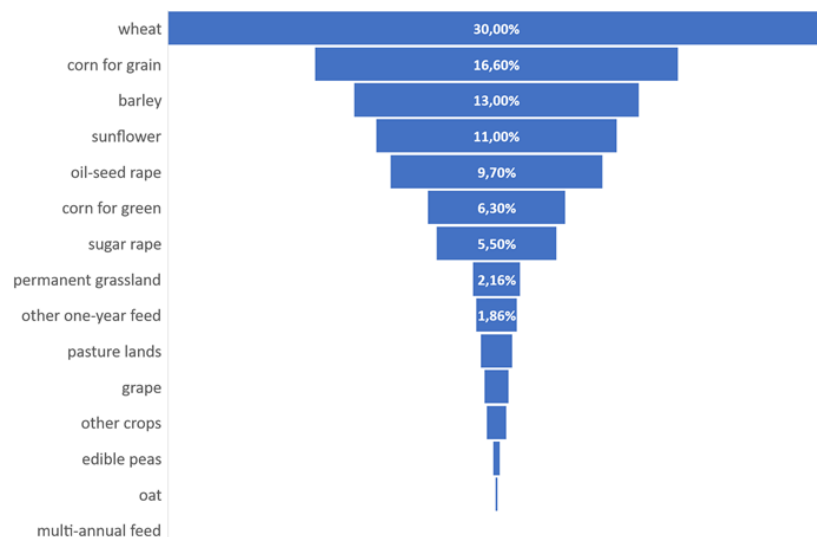

Fig. 3 – The optimal solution for sowing plan without subsidies, Savage criterion. Source: own research

By using the Savage process, if we are not taking into account subsidies, is worth to grow wheat on 30% of whole area, on 16% corn for grain, on 13% barley and non 11% sunflower. Oil-seed rape should occupy 9.7% of area corn for green 6.3 %, sugar rape 5.5% and permanent grassland 2.16%. Other one-year feed is recommended to grow on 1.86% of cultivated area. Pasturelands should occupy 1.47% of area, grape 1.1%. Other crops, edible peas and oat should occupy less than on 1% of area. Growing of multi-annual feed is considered as not effective. By application of the Savage criterion in corn region of Slovak Republic can be expected without subsidies minimal loss 1689.41 EUR. ha<sup>-1</sup>. By using mentioned principle by additional 1% of area for grain corn could bring decrease of expected loss by 0.71 EUR. ha<sup>-1</sup> in addition, corn for green could bring increase by 2.61 EUR. ha<sup>-1</sup>, as dual prices are indicating. Into the solution, get also crops with very low values, which in other criteria were not success. However, for multi-annual feed there is not space for percentage representation. Sowing them on 1% of area, loss would be increased by 1.13 EUR. ha<sup>-1</sup>, what reduced cost also are showing.

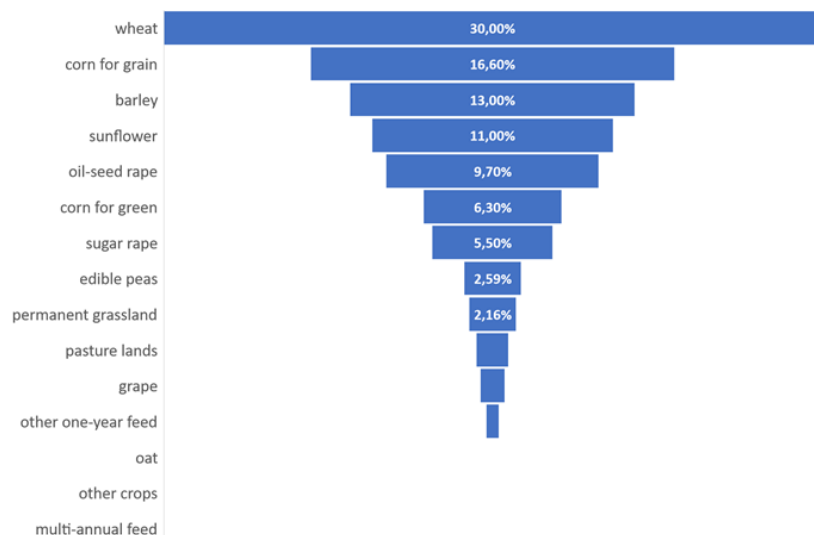

Fig. 4 – The optimal solution for sowing plan with subsidies, Savage criterion. Source: own research

Using Savage criterion, taking into account subsidies, there is difference in optimal crop production for oat and other crops, which are not in optimal solution. Edible peas should be on bigger area (2.59%) from total cultivated corn area. Conversely, on the smaller area is recommended to sow other one-year feed (0.59%). Rest of the crops remain without perceptual change of the area. The decision maker can expect, that by using of the Savage criterion in corn region of Slovak Republic with considering subsidies minimal loss by should not exceed 1830.86 EUR. ha<sup>-1</sup>. Based on the shadow price, we can say that the most negative impact by 1% of increasing area would have corn for green. It would increase the loss by 4.35 EUR. ha<sup>-1</sup>. Positive impact on hectare loss would have increasing of area of sugar rape by 1%. Hectare loss will be reduced by 17.82 EUR. ha<sup>-1</sup>. Sowing of multiannual feeds on 1% of area would cause the biggest increase of loss, by 3.47 EUR. ha<sup>-1</sup> and oats the lowest, 0.54 EUR. ha<sup>-1</sup>, because it did not get into the optimal solution.

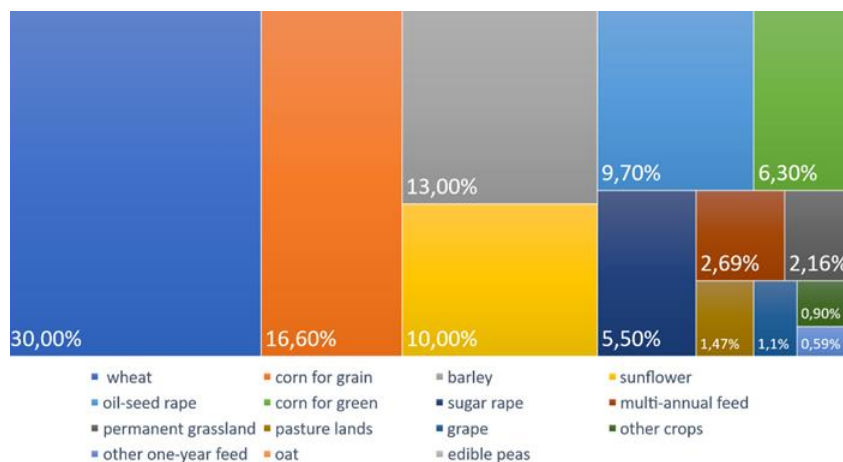

Fig. 5 – Expected optimal sowing structure without subsidies, Agrawal-Heady criterion. Source: own research

The Agrawal-Heady expression, without subsidies, is not accepting grow of oats and peas. The leading position maintains wheat (30%), followed by corn for grain (16.6%), barley (13%) or sunflower (10%). Based on the optimal solution, oil-seed rape should occupy 9.7%, corn for green 6.3% and sugar rape 5.5% of area. Multi-annual feed (2.69%) should be sown on a smaller area. Permanent grassland should have an area of 2.16%, pasture lands 1.47%. Grapes should be grown on 1.1% of the total area. Less than 1% of arable land should occupy other one-year feeds and other crops.

The optimal structure based on Agrawal-Heady principle will provide the highest profit against the most inappropriate option 278.95 EUR. ha<sup>-1</sup> without subsidies in maize area of the Slovak Republic. Based on the principle, an increase of sugar rape area by 1%, would be expected increase of profit by 9.34 EUR. ha<sup>-1</sup> and in case of permanent grassland decrease by 0.76 EUR. ha<sup>-1</sup>. By planting edible peas on 1% of the soil, we will reduce expected profit by 1.44 EUR. ha<sup>-1</sup>. By including oats in the sowing plan, we will cause reduction of expected profit by 0.51 EUR. ha<sup>-1</sup>.

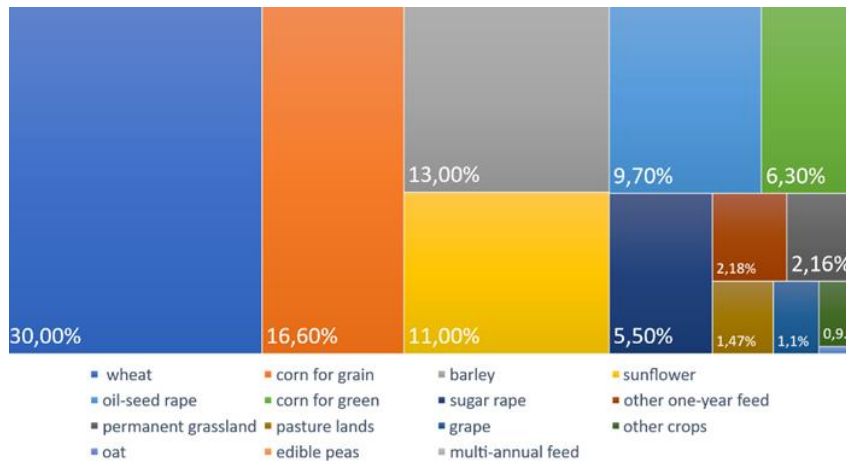

Fig. 6 – Expected optimal sowing structure with subsidies, Agrawal-Heady criterion. Source: own research

If we are taking into account subsidies, the Agrawal-Heady criterion will not get the edible peas into the optimal crop plan as in a model where we are not taking into account subsidies. In contrast with previous model, multi-annual feed is not in the solution. Wheat, corn for grain, barley, sunflower, oil seed rape, corn for green, sugar rape, permanent grassland, pasturelands, grape and other crops have same percentage in total area as well as in the Agrawal-Heady criterion without subsidies. However oat with 0.10% of area got into the solution and other one-year feed by should occupy 2.18% instead of 0.59% of the total area.

Taking into account the subsidies, applying of this criterion, we can expect the biggest profit against the worst inexplicable variant 399.44 EUR. ha<sup>-1</sup> in Slovak Republic. Increasing of the area by another 1% for sugar rape can increase expected profit by 16.45 EUR. ha<sup>-1</sup> and in case of extension of grass field, can be expected decrease by 0.92 EUR. ha<sup>-1</sup> as resulting from dual prices. Out of the question is to grow only two crops – peas and multi-annual feed. If we had to put these crops in to the crop strategy, this would have a negative impact on the expected yield per hectare. In case of edible peas, expected profit would fall by 0.93 EUR. ha<sup>-1</sup> and multi-annual feed by 0.08 EUR. ha<sup>-1</sup>.

## 5 CONCLUSION

In the presented article, three decision-making criteria were used. Based on that was identified optimal sowing plans. By using of all principles, it is considered to grow wheat on the largest area as best solution. It should represent more than quarter of the disposition area. On the second biggest sowing area is corn for feed and shows the best economical results of crops. It is probable due to the fact, that it is not so sensitive for dry periods of year, climate warming helps him. Third in the row, barley should be sown in a large amount compared to other crops. A sufficient percentage should also cover area for sunflower or oil-seed rape. Although the sunflower has a lower long-term economic return than rape, which achieves high stability and is better in terms of production economics. Feeds on arable land have a lower economic advantage that thick sown crop. Also because of this factor, the results recommend to sow corn

for green on a smaller area than previous commodities. However, when sowing is being determined, should be taken into account also animal production requirements. If the possibilities of sugar rape growing are not limited, its area would be very large compared to the finally determined area. The reason is its high economic value and special additional titles. In the smallest percentage distribution, permanent grassland, pastures, vineyard, other one-year feeds and multi-annual feeds. Growing of remaining crops was identified as ineffective. Oats belong to marginal crops in terms of growing areas and they appear as more profitable than rye, which also is not in the optimal sowing program. Also, edible peas in not in this program because is highly unstable and is in long-term negative numbers from economic point of view. Neither grape is not so significant to be in the classification. Their need for inclusion would lead to a decrease of expected profit. Regarding the impact of changes in the structure, the biggest effects would be the change of area by additional % from overall land used in corn region. The greatest positive effect in terms of all criteria on the value of expected benefits would be mainly caused by sugar rape, particularly also corn for feed and oil-seed rape with higher values. Negative impact would have the sowing of corn for green, sunflower for seed or wheat. In addition, grasslands and pastures would have negative impact on the game result. By the analysis, we found that in order to identify optimal sowing on the land, subsidies would not have significant affect. The effect would only be reflected in the expected profits over the worst variant in appropriate nature status or in case of loss over the best option in appropriate nature state.

## References

- Bezat-Jarzębowska, A., & Rembisz, W. (2013). Efficiency-Focused Economic Modeling of Competitiveness in The Agri-Food Sector. *Procedia - Social and Behavioral Sciences*, 81, 359-365. doi: 10.1016/j.sbspro.2013.06.443
- Dantzig, G. B. (1951). A proof of the equivalence of the programming problem and the game problem. In T. C. Koopmans (Ed.), *Activity Analysis of Production and Allocation*, London: Yale University Press.
- Démuth, A. (2013). *Teória hier a problém rozhodovania*. Trnava: Filozofická fakulta Trnavskej univerzity v Trnave.
- Goga, M. (2013). *Teória hier*. Bratislava: Iura edition.
- Grasseová, M. (2013). *Efektivní rozhodování*. Brno: Edika.
- Hrablík Chovanová, H. (2014). The manager and making of decision. *Časopis výzkumu a aplikací v profesionální bezpečnosti*, 7(1). Retrieved from <http://www.bozpinfo.cz/josra/josra-01-2014/manazer-a-rozhodovanie.html>
- Figiel, S., & Rembisz, W. (2009). *Przesłanki wzrostu produkcji w sektorze rolno-spożywczym - ujęcie analityczne i empiryczne*. Warsaw: IERiGŻ-PIB.
- McCown, R. L. (2002). Locating agricultural decision support systems in the troubled past and socio-technical complexity of 'models for management'. *Agricultural Systems*, 74(1), 11-25. doi: 10.1016/S0308-521X(02)00020-3
- MPRVSR (2014). *Ministerstvo pôdohospodárstva a rozvoja vidieka SR: Zelená správa 2014*. Retrieved from <http://www.mpsr.sk/index.php?navID=122&id=8835>
- Rehman, T., & Romero, C. (2006). Formulating generalised 'goal games' against nature: An illustration from decision-making under uncertainty in agriculture. *Applied Mathematics and Computation*, 175(1), 486-496. doi: 10.1016/j.amc.2005.07.026

- Remešová, M. (2016). *Nákladovost zemědělských výrobků*. Retrieved from <http://www.uzei.cz/nakladovost-zemedelskych-vyrobku/>.
- Repiský, J. (2008). *Teória hier*. Nitra: SPU Nitra.
- Repiský, J. (2009). Optimalizácia výrobnéj štruktúry za podmienok neurčitosti. In *Rozvoj vidieka a spoločná poľnohospodárska politika*, Račkova dolina, 274-281. Nitra: SPU.
- VÚEPP (2019). *Náklady a výnosy poľnohospodárskych výrobkov v SR*. Retrieved from [http://www.vuepp.sk/04\\_naklady.htm](http://www.vuepp.sk/04_naklady.htm)

### Contact information

#### **Ing. Martina Zaujecová**

Slovak University of Agriculture in Nitra, Faculty of Economics and Management  
Tr. A. Hlinku 2, 94976, Nitra, Slovak Republic  
E-mail: [martina.soporova@gmail.com](mailto:martina.soporova@gmail.com)  
ORCID: 0000-0001-8726-5009

#### **doc. Ing. Jozef Repiský, CSc.**

Slovak University of Agriculture in Nitra, Faculty of Economics and Management  
Tr. A. Hlinku 2, 94976, Nitra, Slovak Republic  
E-mail: [jozef.repisky@uniag.sk](mailto:jozef.repisky@uniag.sk)  
ORCID: 0000-0003-3479-0023

doi: 10.7441/dokbat.2019.109

# SMART CITY AND REGION IN THE CZECH REPUBLIC WITH A FOCUS ON THE ZLÍN REGION

*Lukáš Zlámal*

## **Abstract**

Concept of “Smart city and region” uses modern technology to pursue the streamlining of governance, innovation of approaches to the local sustainable development and many more. This paper deals with the area of Smart City and the Region and its current implementation in the Czech Republic with a focus on the Zlín Region. The paper is based findings of previous studies carried out in the Czech environment focusing on all levels of public administration. Consequently, the paper follows with empirical research in selected region of the Czech Republic. The main objective of the research is to analyse the potential of the application of the development concept of Smart city and Smart region in the Czech Republic and selected region in the Czech Republic with regard to the existing Smart development experience and existing professional literature dealing with the issue to highlight the opportunities for further development.

*Keywords:* smart city, smart region, sustainable development, regional development innovation, Czech Republic, Zlín region

## **1 INTRODUCTION**

Nowadays, all territories strive to be modern, interesting, environmentally friendly, sustainable and competitive. How these goals can be achieved is a question that every interested agent in territorial development is trying to figure out. In recent years, there has been an increasing growth of focus upon quality of life connected with the concept of “Smart city”, which is becoming the object of debates worldwide. Smart city as a modern concept is currently perceived by experts as a potential tool to achieve the above-mentioned objectives. Smart City is not only a question of the main management of cities and municipalities - all stakeholders from private, public and academic backgrounds can participate.

The first purpose of this paper is to characterize the basic elements of Smart city and region concept based on existing foreign literature and characterize the current state of implementation of the Smart city and region philosophy in the Czech Republic. The second purpose of this paper is to characterize and to highlight the possibilities for further development.

## **2 SMART CITY AND REGION PHILOSOPHY**

Increasing activities related to the implementation of the concept have made it possible to identify cities that are actively committed to building an intelligent environment at different levels. Riva Sanseverino, Riva Sanseverino and Vaccaro (2017) mention in particular the areas of Amsterdam, Stockholm, Milan and Singapore, which are in society most commonly referred to as Smart cities .What Smart City is and since when can we call it Smart? Nowadays these questions cannot be simply answered. Smart city is a complex that is formulated and transformed every day. The idea of Intelligent city did not arise out of nothing but has been forming by social and economic factors, governance mechanism and many others - the Smart city concept is not a state but a long-term process.

In the context of increasing attention to the new Smart philosophy according to Caragliu, Del Bo and Nijkamp (2011), there is no general interpretation of concept. The formulation of basic characteristics is based mainly on historical development. The concept of smart cities finds Anthopoulos (2017) a relatively young idea and assigns its beginning (like many authors) towards the end of the 20th century. Beginning of the 1990s, the experts consider as an important period in terms of forming the basic attributes of Smart city - especially ICT technologies. Rafiq et al. (2013) point out the trend great of the ICT technologies and the role of innovation in the ICT sectors and Caragliu, Del Bo and Nijkamp (2011) its boom among wide audience in European countries early 1990s. Author mention as one of the main reasons of today's focus mainly on ICT technologies.

It is rather challenging to mention all areas related to Smart city. According to Bolívar and Meijer (2016) governance, technology, communication, transport, infrastructure, people, economy, environment, natural resources, healthcare, innovation and quality of life are just a fraction of the factors involved in the birth of smart cities. Neirotti et al. (2014) further define areas according to the necessity of developing ICT technologies for a specific area, such as energy grids, transport, mobility and logistics, waste management and public security. Neirotti et al. (2014) mention, for example, education, which they consider as an area that does not require a significant representation of ICT technologies.

Barrionuevo, Berrone and Ricart (2012) characterize Smart city as use all available technology and resources in coordinated manner to develop urban centres that are at once integrated, habitable, and sustainable. Komninos (2011) perceives Smart city as territories with capacity for learning and innovation, which is built-in the creativity of their population, their institutions of knowledge creation, and their digital infrastructure for communication and knowledge management. Benevolo, Dameri and D'Auria (2016) mention the basic aspects of Smart City into three main topics: Digital city, Knowledge City, Green city. Benevolo, Dameri and D'Auria (2016) and Riva Sanseverino, Riva Sanseverino and Vaccaro (2017) complement the literature with the following aspects of Smart: Sustainable city, Talented and creative city, Ecological city and Connected city.

Zanella et al. (2014) specify the main barriers of Smart City development into three main dimensions. The smart city area is rich and extends to many developing areas. This fragmentation consequently requires the involvement of many stakeholders. According to the Zanella et al. (2014), the political dimension plays an important role in the decision-making power of all participating stakeholders, which can be eliminated by institutionalizing the idea of Smart City. In the technical dimension, Zanella et al. (2014) emphasize the diversity of technologies and the inability of systems to provide services and collaborate effectively. The last financial dimension related to current global trends affecting the economy and investment in public services. As the main problem, Zanella et al. (2014) find lacking a clear business model and believe that this absence hampers the development of the Smart City concept and is therefore needed to develop those services that support social services with a very clear return on investment. Vesco and Ferrero (2015) state that the aim of implementing the Smart City concept in general is to achieve a level where the city is digital, open, cooperative, prosperous, clean, safe and of general interest to citizens.

### **3 METHODOLOGY**

The main objective of the research is to analyse the potential of the application of the development concept of Smart city and Smart region in the Czech Republic and selected region in the Czech Republic with regard to the existing Smart development experience and existing professional literature dealing with the issue.

In the introductory phase of the research represented in this paper, the author focuses on the approaches of Zlín region of the Czech Republic to the topic of Smart city and region concept. The aim of this phase is to obtain qualitative data, which subsequently served as a basis for quantitative research. A specific group of 20 respondents was selected for the initial survey: organizational units and organizations of the statutory city of Zlín and Zlín region, private sector representatives that are given its core competence for the implementation of the Smart City concept. Respondents were selected by the researcher to represent the most common development areas: transport, environment, ICT, energy, waste management, etc. The interviews were realizing for the research at the turn of February and October 2019. Within the framework of the project “Information Bridge III: Smart City as a Source of Development of the Czech-Slovak Border Region” a questionnaire survey among 36 municipalities in the Zlín region was carried out among representatives of towns and municipalities. The purpose of this phase is to verify the findings from qualitative research. The survey interviews were realizing for the research at the turn of August and October 2019. The questions were chosen based on the results of interviews and empirical experience of the author. The choice of questions also took into account possible size groups of municipalities - the questions were adapted primarily to the conditions of smaller municipalities. Thus, specific research questions were identified regarding the main objective of the research.

*Q1: How does the Zlín region perceive the Smart City development concept and what are the main attributes of this idea?*

For Smart city, there is no uniform interpretation of the concept and gives extensive freedom for individual interpretation. The implementation of the concept depends largely on the leadership of regions and municipalities. The question seeks to approach the region's view of Smart City - the question also monitors whether the region follows the current trend where the main attention is paid to ICT technologies.

*Q2: Is there a demand in Zlín region for anchoring and implementation of the SC philosophy?*

Smart city is a current worldwide trend, which is the subject of professional debates. The question aims to find out whether there is a demand for the implementation of the Smart city concept in the Zlín Region.

*Q3: What are the main potential benefits that can be expected?*

*Q4: What are the main constraints and unfavourable aspects that can be expected?*

Questions Q3 and Q4 regarding anticipated benefits and limits are linked to question Q1. Due to the individual implementation of the concept, it is also possible to anticipate different benefits and limits for individual territories. The question tries to identify the basic possible future direction.

The additional aim of the paper is to elaborate a theoretical and practical basis for opportunities deepening on the existing knowledge of the concept in Czech Republic. Primary and secondary data were used for the research. Secondary data were based on available methodologies and currently prepared methodologies. The research also follows the author's research focused on the characteristics of the Smart environment in the Zlín and Trenčín regions. This work aims to better acquaint readers with the issue of Smart city in the Czech environment and characterize in more detail the current attitude of cities and municipalities in the Zlín region.

## **4 SMART CITY CONCEPT IN CZECH REPUBLIC**

The concept of Smart Cities is addressed and also occupied by the Ministry of Regional Development as the main coordinator of the concept development for the Czech Republic,



which developed a general methodology called “Methodology of the Concept of Smart Cities”. The methodology is intended for both city management and local government employees who are involved in the preparation of SC concepts in the areas of transport, energy and information and communication technologies (ICT). Due to low use and public interest in the methodology of the Ministry for Regional Development, analyses and projects mapping the implementation and development of the Smart City idea are currently underway in the Czech Republic.

The following part deals with the characteristics of the current concept of Smart City in the Czech Republic. The project of the Ministry of Regional Development, which was elaborated by a team from Mendel University in Brno, was chosen as the information source. The title of the project is “Analysis of the current level of participation in the Czech Republic in the concept of smart city and smart region related to new trends, including draft measures” and its processing took place between 6 March 2018 and 25 September 2018.

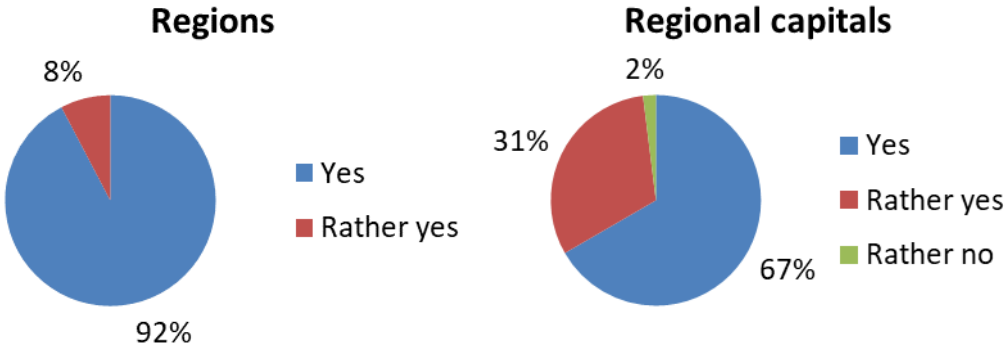

Fig. 1 – Interest in building a smart environment. Source: own research

Thirteen representatives of the Regional authorities, representatives of the City of Prague, 13 representatives of regional capitals and 51 municipalities were addressed. At present the implementation of the Smart city and region concept prevails at the level of individual municipalities in the Czech Republic – increases in numbers of strategic Smart documents, projects and conferences and many other activities related to building smart cities can be seen. Based on these graphs, it can be concluded that there is a demand for grasping the Smart city concept in the Czech Republic. The research thus focused mainly on higher territorial units and more dominant cities - thus the question of attitudes of smaller municipalities arises.

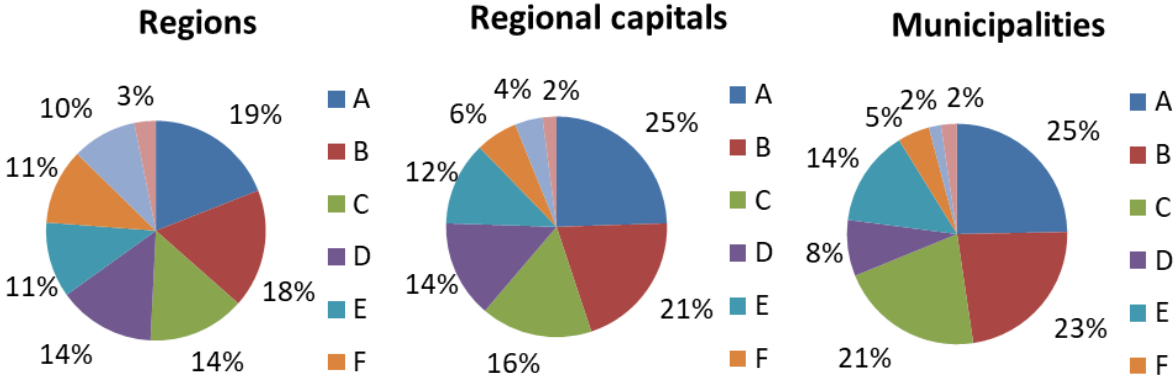

Fig. 2 – The main areas of Smart City and Smart region in relation to strategic planning. Source: own research

Legend:

- A. Sustainable mobility
- B. ICT and efficient management

- C. Sustainable energy
- D. Health, safety
- E. Environment
- F. Culture and tourism
- G. Innovation and business development
- H. Education and sport

Based on the research carried out and respondents' answers, it can be said that in the Czech Republic there is an even fragmentation of the main Smart Development areas. However, a slight preference for Smart Mobility can be seen.

The following table shows the basic Smart City areas of the Czech Republic regions mapped by the Ministry for Regional Development. The table shows the basic direction of selected regions without the capital city of Prague. We can see that there is some difference in the direction and support of Smart areas. However, strong support can be seen in the areas of transport, energy and ICT.

Tab. 1 – Smart city areas in regions of the Czech Republic. Source: own research

Královéhradecký	Partner network building, Knowledge support, Support deployment of smart technologies
Moravskoslezský	Health protection, life protection, finance, energy saving, ICT; smart transport card, public Wi-Fi
Vysočina	Energy, transport, environment, IT, education, tourism
Liberecký	Transport, economic development and tourism, health service, environment, education public administration, social area
Zlínský	Partnership, networking and environment creation, Human resources, education and employment, support of SMART solutions and their integration into a functioning whole
Olomoucký	Smart municipalities, ICT, transport, energy, environment, smart office
Jihočeský	Mobility, ICT, Energy, Environment, Health and Social Services, Effective Territorial Management, Innovation
Jihomoravský	-
Středočeský	Smart accelerators
Ústecký	Health protection, life protection, finance, energy saving
Karlovarský	-
Plzeňský	Smart accelerators
Pardubický	Energy, transport

The following part deals with the characteristics of the current concept of Smart City in the Czech Republic. The project of the Technology Agency of the Czech Republic, which was elaborated by a team from Tomas Bata University in Zlín, was chosen as the main information source. The title of the project is “Methodology of application of smart governance approaches governance into organizational and management structures of municipalities in the Czech Republic” and is still in progress. 325 municipalities were chosen as a research sample.

Under the conditions of the Czech Republic, we can discuss the support for building an intelligent environment. Based on the research carried out between regions and cities, a positive approach for the implementation of the concept of Smart city and region prevails. In general, it can be stated that in the Czech Republic there are three dominant Smart City areas: Sustainable Transport, ICT and Energy. In terms of strategic planning, the priority is given to the area of sustainable transport, in terms of investment priorities it is ICT technologies. From the point of view of the implementation of the concept of Smart City and Smart Region, it is an important finding that almost no territory uses the Smart City methodology issued by the Ministry for Regional Development. It can be assumed that the individual approach will prevail.

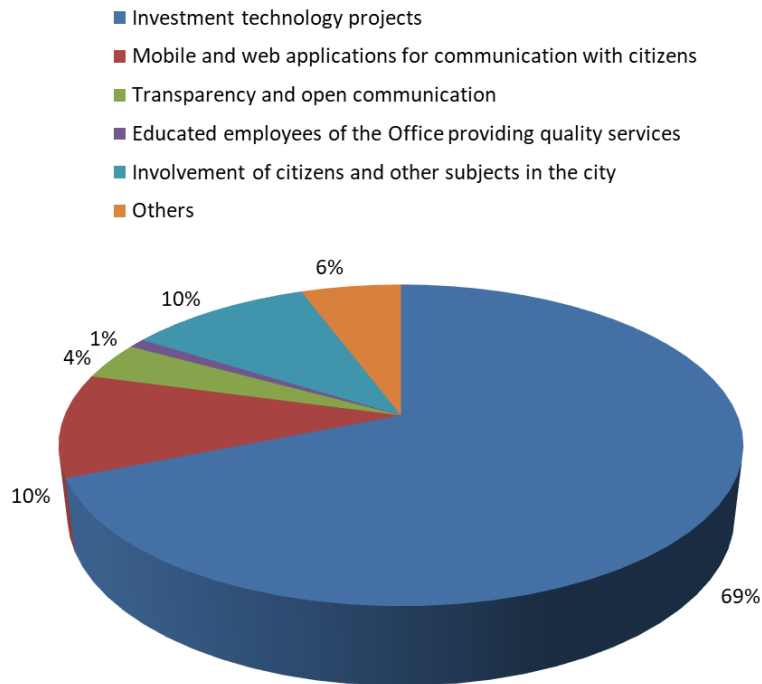

Fig. 3 – Investment priorities. Source: own research

## 5 SMART CITY CONCEPT IN ZLÍN REGION

By its development priorities, Zlín Region has been striving for a balanced development of its territory, increasing its territory competitiveness, attractiveness, and quality of life. The Zlín region is currently working on a conceptual document that is interconnected with the will comprehensively address the issue of Smart City and its partial thematic defines the role of the Zlín region and sets the framework and principles cooperation of the territory in this issue. So far, these are topics dealt with at an ad-hoc regional level.

### 5.1 Findings regarding city concept awareness status (knowledge of the concept and its characteristics)

The majority of respondents understood the term Smart city a certain development concept that deals with data integration, smart technology implementation and new trends in city management - the role of ICT technologies was particularly emphasized. The central collection was considered as the basis for the development of the Smart city concept. The Invipo system, which is currently being developed in the city of Zlín, has been mentioned as an example.

The role of foreign experience was emphasized. According to respondents, the Zlín Region should draw on experience from abroad. The Respondents stressed that this is a relatively young global concept, which began to build in the Czech Republic with a significant delay compared to neighbouring countries. Respondents often mentioned (in the Czech Republic) the city of Brno as a more advanced city approaching the idea of Smart city - especially in the area of ICT technologies. Among the foreign cities mentioned were: Vienna, London, Amsterdam Barcelona

At the same time, they pointed out the negative trend of the concept implementation in the Czech Republic, where, according to the interviewees, a strong marketing approach of the concept for mere visibility of the territory prevails instead of real construction that would capture the full essence of Smart city philosophy. The respondents cited sub-areas, which in their opinion are part of the Smart city concept. The most commonly mentioned areas were:

transport, security, ICT technology, energy, city management, strategic development, waste management and environment. It should be stressed out that all respondents mentioned two areas: ICT technology and intelligent transport. More than half of respondents perceive investment technology projects such as sensors in transport or waste management, energy savings, etc. under the idea of intelligent cities. Thirty percent of respondents find the main investment priorities in reducing energy intensity. We can also mention ICT and mobile applications, which were marked by 22% of respondents.

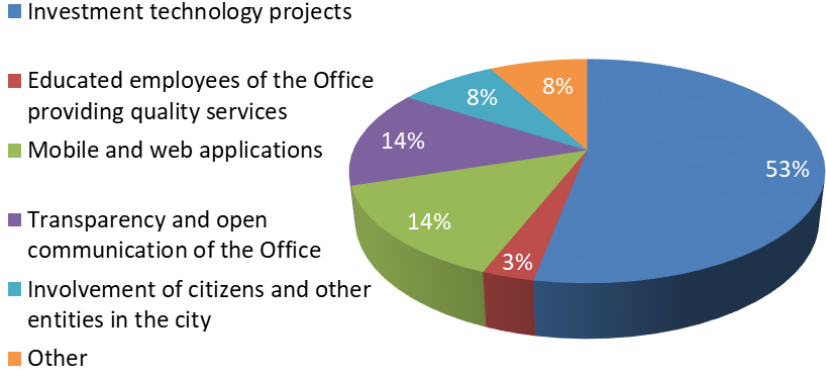

Fig. 4 – Knowledge of the Smart concept and its demand. Source: own research

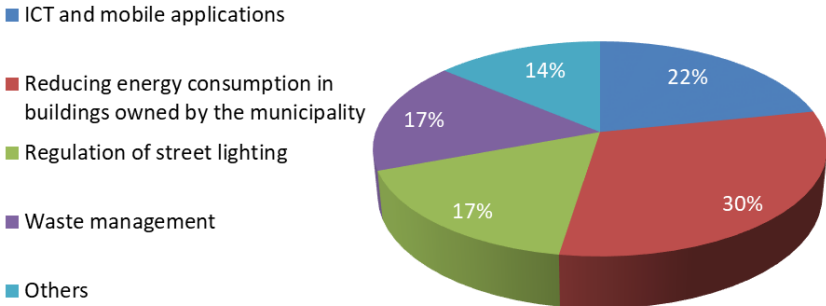

Fig. 5 – Main investment projects in Smart city implementation. Source: own research

**5.2 Findings regarding demand for conceptual anchoring and coordination of Smart City implementation**

The vast majority of respondents agreed on the need to introduce a combined approach (conceptual and coordinated approach) to the implementation of the concept in terms of statutory city of Zlín and Zlín region. Two respondents were neutral. On the contrary, none of the respondents would have preferred purely project approach. Respondents were positive for the introduction of the Smart City concept, but stressed out that they did not perceive the concept as the primary tool for fulfilment of basic strategic goals and visions of the city, but as a means of the level development of the city. The concept of smart cities should not replace the basic (existing) development documents – according to respondents the smart city document must develop current development topics. The need for the establishment of a competent coordinating body; drawing inspiration from other cities and abroad, the need to reduce administrative burden, emphasis on trust and openness.

Forty-seven percent of the municipalities involved in the project put medium importance on the modernization of municipalities and cities. Eight percent of the municipalities involved do not seek to modernize their municipality. An important finding here is that 42% of municipalities regard the idea of Smart City as a low priority.

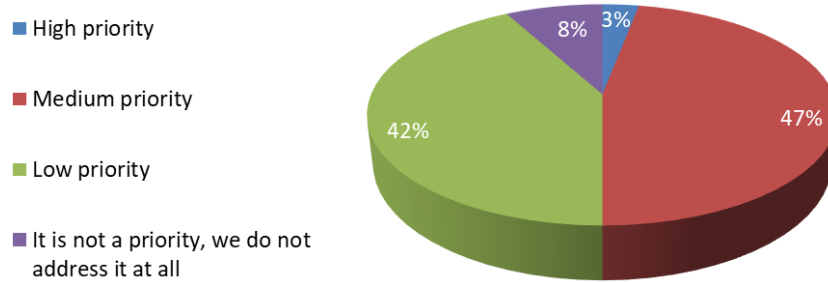

Fig. 6 – Attitude to Smart city projects. Source: own research

### 5.3 Findings regarding expected limits and benefits

The risk of uneven development of the territory, the unintentional purchase of new technologies and the "random" identification of areas and stakeholder to which the concept will be directed increases. The preference of the conceptual approach was found by the respondent to be wasteful investment in the creation of documents whose stated intentions will not be realized in the future. Respondents also pointed to the low readiness of the city and region for the implementation of the SC. Respondents assigned the concept to the preparatory phase and point to insufficient staffing and lack of partnership for successful implementation of the concept. In relation to the implementation of the Smart region, weaker competences in relation to territorial development are considered as the main pitfalls of the region.

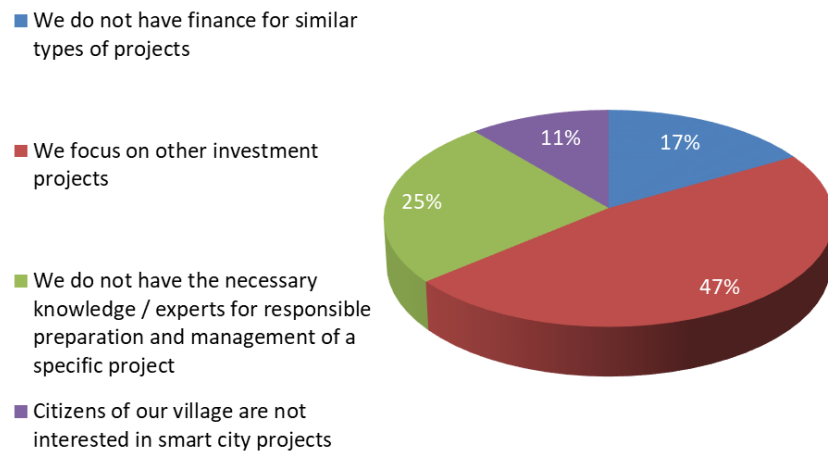

Fig. 7 – The main expected limits. Source: own research

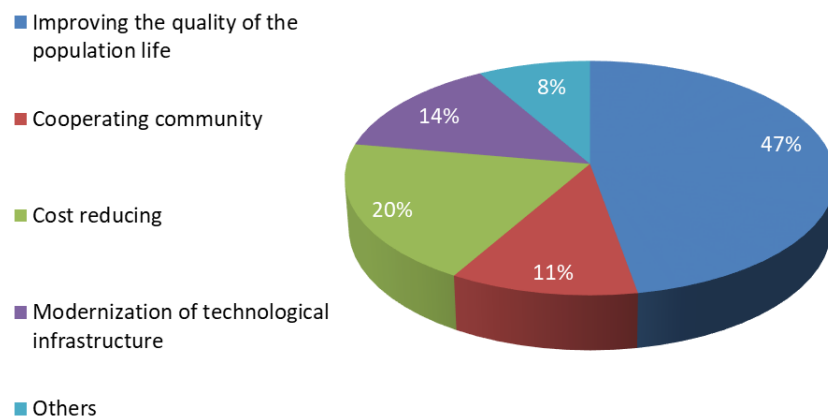

Fig. 8 – The main expected benefits. Source: own research

Respondents see the improvement of quality of life as the main benefit of Smart City implementation. Cost reduction also plays an important role.

## **6 CONCLUSIONS AND DISCUSSION**

Based on the research we can say that Smart city resonates in Zlín Region. Support can be found at all levels examined: regional and municipalities. Overall, respondents' awareness of the Smart City concept can be viewed positively, but it should be emphasized that only a minority of respondents understood the full substance of the concept; the technological aspect prevails over the broader concept of smart cities.

The majority of respondents understood the term Smart city a certain development concept that deals with data integration, smart technology implementation and new trends in city management. In relation to nationwide trends we can say that Zlín Region has a similar focus on sustainable transport and ICT technologies with regard to strategic planning. According to interviews respondents were positive for the introduction of the Smart City concept, but stressed out that they do not perceive the concept as the primary tool for fulfilment of basic strategic goals and visions of the city, but as a means of the level development of the city. According to questionnaires 47% of respondents stated that they focus on other investment projects - it can be assumed that this is mainly due to the concept phase - in the Czech Republic the concept is in the preparatory and initiation phase and the public is only getting acquainted with the idea of the SC. This information shows the current demand for the concept and at the same time it expresses the position of the main barrier of SC development (limit). Respondents see especially the improvement of quality of life as the main benefit of Smart City implementation - cost reduction also plays an important role.

The analysis is a part of a long-term research. Many experts claim that modern transport problems can no longer be solved solely by the physical construction of new roads, nor by the reconstructions of existing roads. In this respect, significant scientific and research efforts have been made for a long time, to address the problem of transport using new information and communication technology resources and novel knowledge on how to run such complex systems and processes. Current state of mobility of most territories seems to be often unsustainable. To remodel them into sustainable form, it would require a long-term transition with needed technical and non-technical changes. How to approach and formulate individual solutions is a crucial issue. The existence of factors such as technical requirements of the transport system, organizational models, regulatory framework and user habits strongly influence decision-making processes.

New efficient transport systems, research, innovation and development in the transport sector have a significant impact on the formation of the economic state of the territory, job opportunities, integration of society and the formation of basic conditions for the life of the population.

Smart mobility is one of the most difficult topic to face in large metropolitan areas. It involves both environmental and economic aspects, and needs both advanced technologies and virtuous behavior oddwellers. Smart Mobility is largely permeated by ICT, used in both backward and forward applications to support the optimization of traffic fluxes, and also to collect citizens' opinions about live ability in cities or quality of local public transport services.

The main objectives of the long-term research include identification of the applicability of the Smart region concept in the field of transport for Czech regions on the basis of a model based on key dimensions identified in existing literature and the creation of a theoretical core for the practical opportunities of the Czech regions, which will lead to economical, efficient and

effective building of Smart transport. The prerequisite for the contribution of the work is mainly in reduction of the limits, structural disproportions and transport imbalances in the Czech Republic / regions. Formulation of positive facts, favourable factors and assumptions for possible future development of the regional transport sector. Addition of the missing information knowledge Smart region and Smart transport for regions of the Czech Republic.

Formulation of new knowledge of intelligent approaches and solution methods for the development of selected transport areas for individual regions of the Czech Republic, which can be expected to contribute to the development of an intelligent transport environment, which will lead in particular to:

1. Reduction of pollution
2. Reducing congestion
3. Increasing the safety of traffic participants
4. Reducing noise pollution
5. Improve bit rate
6. Increasing the comfort and awareness of the traffic participants

Basic scientific questions of long-term research:

Q1: What is the financial return from the implementation of the SC concept?

Q2: What role do the public sector, private sector and academic environment play in the SC environment?

Q3: How can be the Smart city concept measured?

## References

- Anthopoulos, L. G. (2017). *Understanding smart cities: a tool for smart government or an industrial trick?* Cham: Springer.
- Barrionuevo, J. M., Berrone, P., & Ricart, J. E. (2012). Smart Cities, Sustainable Progress: Opportunities for Urban Development. *IESE Insight*, 14, 50-57. doi: 10.15581/002.ART-2152
- Benevolo, C., Dameri, R. P., & D'Auria, B. (2016). Smart Mobility in Smart City: Action Taxonomy, ICT Intensity and Public Benefits. In T. Torre, A. M. Braccini & R. Spinelli (Eds.), *Empowering Organizations: Enabling Platforms and Artefacts*. Cham: Springer. doi: 10.1007/978-3-319-23784-8\_2
- Bolívar, M. P. R., & Meijer, A. J. (2016). Smart Governance: Using a Literature Review and Empirical Analysis to Build a Research Model. *Social Science Computer Review*, 34(6), 673-692. doi: 10.1177/0894439315611088
- Caragliu, A., Del Bo, C., & Nijkamp, P. (2011). Smart cities in Europe. *Journal of Urban Technology*, 18(2), 65-82. doi: 10.1080/10630732.2011.601117
- Komninos, N. (2011). Intelligent cities: Variable geometries of spatial intelligence. *Intelligent Buildings International*, 3(3), 172-188. doi: 10.1080/17508975.2011.579339

- Neirotti, P., De Marco, A., Cagliano, A. C., Mangano, G., & Scorrano, F. (2014). Current trends in smart city initiatives: Some stylised facts. *Cities*, 38, 25-36. doi: 10.1016/j.cities.2013.12.010
- Rafiq, G., Talha, B., Patzold, M., Luis, J. G., Ripa, G., Carreras, I., Coviello, C., Marzorati, S., Rodriguez, G. P., Herrero, G. & Desaegeer, M. (2013). What's New in Intelligent Transportation Systems?: An Overview of European Projects and Initiatives. *IEEE Vehicular Technology Magazine*, 8(4), 45-69. doi: 10.1109/MVT.2013.2281660
- Riva Sanseverino, E., Riva Sanseverino, R., & Vaccaro, V. (2017). *Smart cities atlas: Western and Eastern intelligent communities*. Cham: Springer.
- Vesco, A., & Ferrero, F. (2015). *Handbook of Research on Social, Economic, and Environmental Sustainability in the Development of Smart Cities*. Hershey: IGI Global.
- Zanella, A., Bui, N, Castellani, A., Vangelista, L., & Zorzi, M. (2014). Internet of Things for Smart Cities. *IEEE Internet of Things Journal*, 1(1), 22-32. doi: 10.1109/JIOT.2014.2306328

### Contact information

#### **Ing. Lukáš Zlámal**

Tomas Bata University in Zlín, Faculty of Management and Economics  
Mostní 5139, 76001, Zlín, Czech Republic  
E-mail: zlamal@utb.cz  
ORCID: 0000-0002-9456-5103

doi: 10.7441/dokbat.2019.110



# LOGISTICS MODEL FOR E-COMMERCE IN AN ONLINE COMPANY

*Artur Zygiert*

## **Abstract**

The article fulfils its assumptions and tries to give a background, introduced the importance of logistics in business activities in virtual space, using theoretical knowledge, creating the basics on which the content of the work was put. The paper is descriptive based on empirical experience. The main e-business concepts, business models and logistic models used in running a business are explained. The main idea and premises for writing the article was the willingness to share knowledge and experience resulting from own business practices. The aim of this work is to present an online logistics model for an online company under the brand name Virtual Kingdom of Culture, developed for an online company. The aim of the article is to show what benefits introducing of these changes in the distribution of the product will bring and how such a change may affect the value of the organization. The article presents the current logistic situation of the organization, analyses the form in which orders are fulfilled and products distributed. It was presented how the choice was made and what influenced the choice of the implied model. It was shown how the organization solves problems by looking for the most beneficial solutions. It also describes the ways, tools and techniques, thanks to which appropriate actions and decisions implementing the assumed objectives of the organization were taken. Article presented the possible benefits of introducing certain changes in the logistics system and how they will affect the functioning of the company. The importance of logistics in the company's activity was outlined. The results of the research were elaborated on the basis of the application of the case study. Research has shown that the use of more ergonomic storage methods and the appropriate use of modern storage spaces and more efficient modes of transport improves the logistics system in the company. Creating and implementing logistic models tailored to the customer's needs is the key to the success of logistic activities.

*Keywords: logistics, e-business, logistics in e-commerce, logistics model*

## **1 INTRODUCTION**

A couple of years ago, nobody would have thought that a computer could be used to buy or sell goods and services. Today we live in a great hurry, where every minute is worth its very crucial. Going to the shopping mall is time-consuming, there are variety of goods offered to us, thousands of choices, long queues and ultimately lost valuable time. After all, these hours can be used in a different, creative way. Nowadays the Internet came with the help to those tired customers, where you can make purchases in a quick and easy way. E-commerce is nothing more than a complex process of concluding commercial transactions by electronic means conducted over the Internet (Wrycza, 2010). Sales via the Internet is a very dynamically developing sector in trade, which forces to send goods using the services of postal operators or courier companies. Professional online shops have their own logistic infrastructure, their own warehouses, transport, creating logistic networks. Thanks to this, they can store and send parcels, transport shipments to their customers freely and safely. Such solutions require appropriate planning, preparation and investment. The adjustment of the entire logistics infrastructure in e-commerce is strictly determined by the type of business, the requirements of the specific field of trade. In order to implement logistic projects well, operators should undergo logistic training, and managers must gradually invest in such training, which results in the development of the company and affects relations with customers. The need for staff

development is influenced by the growing and changing requirements of customers, which are the result of constantly growing competition in the logistics services market. The dynamic growth of the Internet commerce has led to the need for an appropriate nomenclature for this type of activity.

E-commerce is a bravery that consists in selling products and services via the Internet. The e-commerce activity is also selling on Internet auctions via websites that are not shops as well as direct sales via e-mail (Majewski, 2007). In everyday life, the role of e-commerce is still growing which shows dynamically growing value of sales via the Internet. All logistical activities related to e-commerce create a logistic process, which should be understood as an ordered chain of all operations related to the flow of materials, means or information.

## **2 SELECTED LOGISTIC MODELS IN E-COMMERCE**

There is no doubt that logistics plays a major and fundamental role in e-commerce. A logistics system is nothing more than the movement and storage of certain goods, as well as the related transfer of information and disposal on the consumer goods market, which is the result of the concepts and actions of suppliers (Wojciechowski, 2003). Logistics is a concept of management with the flow of goods, as well as information, starting from the moment of obtaining raw materials to the recipient, i.e. the customer. Logistics focuses its activities on three types of movements, namely movement of raw materials (the supply stage), movement during production (the stage of production) and movement of finished products (the marketing stage) (Waters, 2001).

The logistics system should ensure that the necessary input materials (raw materials, auxiliary and consumables), as well as products or semi-finished and finished products, are available at the right time and place, in the right quantity and of satisfactory quality for the customer (Vollmuth, 1995). Logistics is currently a branch of knowledge which, using IT systems, aims at achieving integration across organizational divisions of enterprises. This ensures optimal shaping of supply chains, from the moment of obtaining materials or products, through their processing, distribution in various branches of the trade, to the final buyer (Kuc & Gliński, 1996). It should be noted that logistics performs a number of important functions. It is transport, purchasing by purchasing, receiving, storing and storing, controlling the quantity of products in the warehouse, taking up materials, packing of sent products, as well as location and communication.

The newly developed model of the logistics system should consist of three main parts: (1) logistics procurement, specifying the need to construct a system model, the scope and length of the logistics chain needed, the quantitative scale, the frequency of flow, the degree of dependence on the functioning of other chains, conditions and restrictions, etc. 'logistics procurement', specifying the need to construct a system model, the scope and length of the logistics chain needed, the quantity scale, the frequency of flow, the degree of dependence on the functioning of other chains, conditions and restrictions, etc.; (2) the initial concept, and then the empirically verified concept, of information flows allowing for the initiation, conduct and ongoing correction of the real flow chain; (3) the organizational and technical concept of the functioning of the real flow chain from the point considered in the "order" as its beginning to the point where it is assumed that the material supply batches (undergoing gradual transformation) have finished their course, i.e. have been disassembled, processed or consumed". (Korzeń, 1998)

## 2.1 Logistics models operating on the e-commerce market

The most common logistic form used in e-commerce is the adoption of external, already existing logistic networks adjusting their infrastructure to the nature of the company's activity. Costs incurred by the organization because of logistic activities are a significant factor in the choice of logistics service. A huge potential for the development of logistics in e-commerce was noticed, which resulted in a large development of companies providing goods delivery services to customers purchasing networks. The on-line payments caused the optimization of the purchasing process and the growing competition of logistics companies allowed reducing the costs of services provided significantly.

One of the logistic models in e-commerce is having its own warehouse for storing and distributing goods. Such a solution implies that the trader may own an exclusive product as its owner. In this model, it is also necessary to "store" a certain amount of goods, especially in companies that offer a wide range of assortment, range of product variants. This problem is particularly acute for companies that are just beginning their adventure on the market and do not have trade credits or payment terms. This is why, for financial reasons, many shops restrict access to a particular range of products. In this model, it is undoubtedly important to have adequate warehouse space, where it is good to invest in the insurance of the room, goods, and their monitoring or even protection. Unfortunately, this generates additional costs for the entrepreneur. A big advantage of this model is the ability to make the transactions, which quicker reflects into greater satisfaction customers who return to shopping in the store willingly, as well as recommend it to their friends. However, there is a dependence on suppliers, which causes some problems with temporary shortages or on-time delivery. The disadvantage of such a solution are investment costs and warehouse maintenance costs. One of the most frequently chosen logistic models in e-commerce is Dropshipping. It involves transferring the process associated with the shipment of goods to the supplier, and the role of the online store is only to collect orders and send them to the supplier who is fully engaged in the delivery of goods to the target customer (Chodak, 2008). The profit from such logistic solutions results from the intermediation between the wholesaler and the customer. In such a model, an important element is an old trade maxim that proclaims the slogan "buy cheaper and sell more expensive". The disadvantage of this model is the possibility of mistakes during financial transactions. Outsourcing is a form of Drop-Shopping processes related to e-commerce logistics. Such a solution allows e-shop managers to focus on their core business, i.e. sales development by acquiring new customers, promoting their products and improving their offer. This model allows you to do business from anywhere in the world without personal involvement in packaging and shipping. Trocki (2001) defines outsourcing as an undertaking, which consists in separating from the organizational structure of the parent company the sales objectives, pursued by it and transferring them to other economic entities. According to Kopczyński (2010), it is a transfer of the company's resources to an external entity for use, but it is connected with long-term cooperation with an external entity carrying out the commissioned tasks.

Typical outsourcing activities include Fulfilment, where specific activities are redirected to an external logistics operator. This is nothing more than a warehouse run by an external company. All deliveries flow to the company that also handles the shipping of orders. A huge advantage here is the model of settlements, where you often pay for a given operation, i.e. receiving goods, packing them and storing them. This is particularly beneficial for small businesses.

Among online shops, a popular model is pseudo-just-in-time. This model is connected with displaying the full range of suppliers on the shop's websites. These offers are often referred to as availability dates. It should be emphasized that the goods are ordered at the moment when the customer places the order, it allows to maintain a virtually empty warehouse. A huge

advantage is that the entrepreneur does not need to have a large warehouse space and large funds secured in the goods. There is also no need to invest in insurance or protection. In this model, we also eliminate the risk of customer dissatisfaction with the goods. In this model, it is important to integrate the shop system with the supplier system. Thanks to this integration, we have control over the assortment; we can check which products are available for sale and which have already been sold. However, there is a risk, because the system is not ideal and suppliers may display products for sale as available, where it turns out that the product is unavailable at a given moment of time. In such a case, the order is cancelled or the customer is persuaded to change the order. This model is also characterized by delivery delays.

An interesting model is Extended Shopping, which consists of full service by suppliers. The shop is serviced by the supplier in terms of storage, settlements or possible returns. The entrepreneur directs the functioning of the shop and the rest of the activity falls on the supplier. The downside is the acquisition and going of customers because the entrepreneur has no influence on the service of individual customers. This model is also associated with a lower salary, because only a percentage of profits from the transaction is determined. However, it is beneficial for Internet platforms with large number of users where the entrepreneur does not deal with sales, but as part of the activities of the website wants to run also a shop, from which he or she will benefit. Commodity brokerage is a model that is not very popular on the Polish market. It is comparable to courier services, where a supplier does not have all the goods, only after placing an order, it from his supplier or manufacturer. There are discounts on such orders, from which both contributors can take benefit from. This model minimizes the number of suppliers and shows a wider range of products.

## **2.2 Models operating on the e-commerce market in the service sector**

If you do not want to omit the services sector, it is worth realizing how the logistics network in e-commerce services is formed and built. Logistics in e-commerce also applies to the services market. The operator's services are sold online via websites and platforms. As regards the logistical aspect, it comes down to the gaining and provision of a service, a contract concluded between a direct supplier and intermediary company selling a particular service and a customer, a recipient of the service. Services operating in e-commerce consist in providing users with access to space or software, depending on the needs of the client in the „cloud computing” virtual world. The entire commercial service is provided via the Internet. In this sector of activity, the logistic network consists in providing the hosting service to the customer with the options chosen by him/her. The hosting service consists of a specific server location, web address, software, applications, and support services depending on the selection of the package. When a service option is selected, an individual, specific logistics network is created through which the service is delivered. The form and models of service delivery by means of a medium such as the Internet requires appropriate planning, organization, implementation and control as well as effective flow, collection, storage and access to data, it is a logistic activity in the „cloud computing”. Models used by e-commerce in the service sector to create a „cloud computing” has a significant impact on the logistics system operating for the enterprise. As Kapeliński (2014) notes, in a classic environment data processing takes place on three levels: applications, infrastructure and platform. It is based on some levels that „cloud computing services were created”. Three main models of service delivery have been developed.

Business activities, thanks to which services are provided on the Internet is a hosting package or a set of elements of this offer, which is given by the service provider related to meeting the expectations and needs of the customer. Cloud computing systems build and develop logistics systems. One of the models of such activities is IaaS (Infrastructure as a Service), which is characterized by the fact that the provider provides the entire IT infrastructure, such as the

revitalized hardware, which is scaled according to user requirements. The infrastructure delivered to the user is hardware (servers), software and service creating a logistic network of the delivered service. Another example is PaaS (Platform as a Service), where the provider makes a virtual work environment. Available the service provider, through IT logistics, provides a set of applications necessary for the work, programs located on the servers of the provider. SaaS (Software as a Service) is another model of providing services consisting in providing a program or application. The supplier is obliged to install and manage the application, service and take interest of the provided program. This gives the possibility to access the necessary Internet access program.

Depending on the needs of the conducted e-business activity, the most effective is mixing the models with each other and developing a model that will satisfy the needs of the client and at the same time realize the intended objectives in an effective and efficient way. Making space available on the server, applications, programs, distribution all these factors require creating Internet logistic infrastructure.

### **3 A LOGISTIC MODEL DEVELOPED FOR THE VIRTUAL KINGDOM OF CULTURE**

#### **3.1 Characteristics of the company and evaluation of the current logistic situation**

The Virtual Kingdom of Culture is an online platform operating as a Start-Up non-profit organisation. In the light of the previous reflections on the activities of non-profit organisations, their basic characteristics can be distinguished: carrying out activities mainly of a service nature; the overarching nature of public and social tasks and the focus on higher-order values such as human well-being; implementation of those public and social tasks which result from the state policy and its tasks, or which, despite the existing demand, have not found willing to fulfil them among public and private profit-oriented entities; non-dependence of the conduct of business on economic benefits; recognising the possible profit earned only as a tool for the implementation of the mission and directional objectives; a high degree of dependence on external financing. (Limański, 2017)

In order to characterise an Internet company operating under the brand name Virtual Kingdom of Culture, it is necessary to take a closer look at the values represented by the organisation, which are expressed in its mission, vision and objectives. The main element of company development and strategy planning is the mission, which is the beginning of a number of activities. The mission of the Virtual Kingdom of Culture enterprise focuses strongly on artists and creators of art in all its areas. It defines the creation of such a place in the network where artists and users will be able to share their achievements freely and safely. The platform does not only focus on the presentation but also on the sale of works placed within the framework of the website. The vision that illuminates the path to determine the state of the company in the future is to promote and disseminate a legal culture. The second factor in the vision is the safe promotion of creativity and artistic activities. The objectives to be achieved by the company are to maximise the market value. They focus mainly on reaching as many artists and users as possible, cultural activists as well as people who want to experience art at the highest world level, to support them what the Virtual Kingdom of Culture wants to achieve.

A literature review and a case study were used to investigate the logistics activities at the Virtual Kingdom of Culture company. The case study is an empirical study that explores a contemporary phenomenon ("coincidence") in the context of reality, especially when the boundaries between the phenomenon and the context are not entirely obvious. [...] Case study refers to a technically recognizable situation in which there are many more variables of interest

to the researcher than data points and therefore draws evidence from many sources and confirms the convergence of data by triangulation, and when collecting data, the step-by-step case study and data analysis method refers to previously formulated theoretical assumptions (Dąbrowski, 2017). In order to collect the necessary data by means of the case study method, it is necessary to: (a) identify and define the issues to be analysed; (b) define the research sample (it is often not representative of the general population); (c) for the case under consideration, collect qualitative and quantitative data for analysis at a later stage of the assessment process.

The logistics activities of the Virtual Kingdom of Culture in the product distribution are to ensure that products are delivered safely and in line with the customer's expectations. The logistical objectives set by the organisation are primarily safety in the supply of products. In order to reduce costs, the organization has outsourced and transferred logistics and distribution activities to the customer. After submitting a transaction offer by the user, the user himself makes a bank transfer to the bank account number indicated by himself of the branch by the creator within no more than two business days from the date of concluding the transaction. The Creator is obliged to transfer to the user making the transaction, a copy of the work, which became the subject of the transaction into the address, indicated by the user within no more than two working days from the date of recording the bank transfer. The Virtual Kingdom of Culture leaves the freedom to create a distribution channel for the creator in relation to the user. All distribution activities take place outside the company.

### 3.2 Development of the logistics system in place

A hypothesis was put forward in which it was stated that the development and implementation of an implied logistics system in the relations between the artist and the user would improve the safety of transactions, increase the number of customers, which will directly affect the increase in the financial result. Based on this hypothesis, the development of the logistics system was commenced and divided into stages. The first stage is to define the needs of the beneficiaries, which is presented in the Table 1 below.

Tab. 1 – Definition of the needs of the beneficiaries of the Virtual Kingdom of Culture. Source: own research

LP	Needs	Artist of rank (1-10)	Artist of rank (1-10)	Ranking company (1-10)
1	Security of transactions and delivery	10	10	10
2	Low price for logistics services	1	10	5
3	Short delivery time of the order	8	10	5
4	Customer satisfaction	10	10	10
5	Quality of services	8	10	8
6	Method of payment	6	9	6
	$\Sigma$	<b>43</b>	<b>59</b>	<b>44</b>

The analysis shows that users will play the greatest role in the selection of the logistics system. This target group will have a significant influence on the choice of distribution type. The most important need, which is important for all beneficiaries, is the security of transactions and delivery of the product. Logistic activities should be designed to increase customer satisfaction, and the quality of services provided should be at a level that increases the value of the brand, manifesting itself in an increase in the number of artists and users of the Virtual Kingdom of Culture. It should also be noted that if the transaction and distribution are carried out safely for the contributors, the form of payment would not play a significant role.

The main rationale for developing a logistic model for an organization is to ensure security for transactions and distribution of purchased products. In the second stage, a model dedicated to the Virtual Kingdom of Culture was developed.



Fig. 1 – A model of product distribution for the Virtual Kingdom of Culture. Source: own research

The distribution model prepared for the Virtual Kingdom of Culture presents the way the product will go from the moment the user approves the purchase and makes the payment to the moment the ordered goods are picked up. When a transaction is made between a user and an artist, an order is generated to a logistics operator, which, in accordance with the standards, starts to provide the service. A courier is sent to the address indicated in the order, who with due care receives the shipment and delivers it to the logistics centre optimal for the target recipient. Then the product is redirected and delivered to the customer. Depending on the distance between the Principal and the Contractor, the route may change, so that the indirect storage aspect is omitted and the goods can immediately reach the target customer. It may also happen that the distance will force one more warehouse point to be implemented if the distance is too long.

### 3.3 Analysis of costs and expected profits from the introduced logistics system

Attention should be paid to the costs resulting from the additional activity performed by the logistics service provider, i.e. the movement of the shipment to the customer. Currently, the average cost of shipment in the logistics services sector is PLN 16 (approx. EUR 3). This applies to a service between the principal and the contractor through a logistics operator. What happens in the current situation of product distribution within the Virtual Kingdom of Culture, where all the costs are borne by the user. From the company's data it can be read that the CTR click-through rate is maintained at the level of 3%, SEO positioning generates 4000 page views, which gives 108 page views per day. On this basis, the company receives an average of 3.6 transactions per day and 108 transactions per month. The profit on one transaction is estimated at PLN 50 (approx. EUR 12.5), which constitutes 5% of the income from each successful transaction.

Tab. 2 – Costs and expected profits from the introduction of the new logistics model. Source: own research

	A DURING SITTING		NEW SYSTEM	
	Month	Year	Month	Year
The average cost of the logistics	1728 zł (WKK not loaded)	20 736 zł (WKK not loaded)	3 456,00 zł	41 472,00 zł
Daily number of transactions	108,00 zł	1 296,00 zł	120,00 zł	1 440,00 zł
Profit from one-time transactions	50,00 zł	600,00 zł	75,00 zł	1 200,00 zł
Profit from transactions	5 400,00 zł	64 800, 00 zł	9 000,00 zł	108 000,00 zł
The sum of the costs to be borne by	3 900,00 zł	46 800,00 zł	7 356,00 zł	88 272,00 zł
<b>Profit/Loss</b>	<b>1 500, 00 zł</b>	<b>18 000, 00 zł</b>	<b>1 644,00 zł</b>	<b>19 728,00 zł</b>

The Virtual Kingdom of Culture wants to attribute to itself the costs associated with the additional activity of collecting a postage from an artist. At the same time, it will force the organization to increase the revenue from transaction from 5% to 7.5%. The company assumes that improving the quality of distribution security at the logistic level will increase the number of transactions concluded by 10%. Table 2 shows the expected benefits of such solution.

The analysis of the change in the logistic model shows that if the organization achieves the intended objective, it will achieve the expected financial result. Taking into account the change in the logistics model, the organization has to take into account the increase in transaction fees.

A higher financial result can be expected after the introduction of logistical changes. The increase in the quality of services provided, combined with the security of transactions and distribution, will translate into an increase in the number of artists and users willing to make purchases through the Virtual Kingdom of Culture.

#### **4 CONCLUSIONS**

In the literature on the subject, the issue of the importance of logistics in the functioning of a company is raised. Logistics is often put on an equal footing with marketing and management and shows the relations between these processes. The article shows the positive impact of a properly adjusted choice of logistic model on the organization and how important it is for the company. Each created logistic model presented in the literature on the subject was created from the need generated by the environment, and this model was a solution to emerging problems and difficulties. Using theoretical foundations and substantive knowledge, a logistic solution tailored especially to the needs of the Virtual Kingdom of Culture organisation was implied.

The main observation that comes to mind is the ability to read the needs of the customer, appropriate response to the requirements set by the environment in which the organization operates. The desired attitude in the management of the organization is openness to new challenges, innovation, thanks to which the company strives for perfection. An important message is that logistics activities in the organization have a fundamental impact and should be treated equally to marketing and management. With the right logistics and the right choice of logistics model, the company is able to increase profits and customer numbers, thus building a strong market position and inspiring confidence in the brand. The development and implementation of an implied logistics system will increase the number of customers thanks to the application of additional activities by the operator for security purposes, thus improving the quality of the services provided. The introduction of a modernized logistics model taking into account customer needs will increase the financial result and strengthen the position of the Virtual Kingdom of Culture brand in the market.

#### **5 COMPLETION**

Logistics services will play an important and significant role in the activities and business strategies developed for online spaces. Using more ergonomic methods of storage and use of storage space, more and more modern and efficient modes of transport, reducing the level of bureaucracy, logistics activities will be the main element of planning e-commerce business strategy. They will become a bargaining chip when a suitable service provider is selected. Being competitive with logistics operators in the sector will become increasingly difficult. Logistics is a continuous development, continuous growth and thus a stable element of the Internet business. It is the element that gives an advantage over the competition. Separating logistics activities from among other solutions and giving them a separate role, allows us to put logistics on an equal footing with management or marketing. Creating, developing and implementing customized models to facilitate the delivery of goods and services is key to the success of logistics operations.



## References

- Chodak, G. (2008). Dropshipping: model logistyczny dla sklepu internetowego. In S. Lachiewicz & A. Zakrzewska-Bielawska (Eds.), *Teoria i praktyka zarządzania rozwojem organizacji*. Łódź: Wydawnictwo Politechniki Łódzkiej.
- Dąbrowski, A. (2017). Metoda studium przypadku krok po kroku. *Studia Socjologiczne*, 227(4), 249-262. Retrieved from <https://www.ceeol.com/search/article-detail?id=598768>
- Kapeliński, W. (2014). Kierunki rozwoju chmury obliczeniowej według założeń komisji europejskiej. In A. Nowicki & D. Jelonek (Eds.), *Technologie informacyjne w kreowaniu przedsiębiorczości*. Częstochowa: Sekcja Wydawnictw Wydziału Zarządzania Politechniki Częstochowskiej.
- Kopczyński, T. (2010). *Outsourcing w zarządzaniu przedsiębiorstwem*. Warszawa: PWE.
- Korzeń, Z. (1998). *Logistyczne systemy transportu bliskiego i magazynowania: Infrastruktura, technika, informacja*. Poznań: Instytut Logistyki i Magazynowania.
- Kuc, B. R., & Gliński, B. (1996). *Zarządzanie strategiczne: geneza, rozwój, priorytety*. Warszawa: Key Text.
- Limański, A. (2007). *Marketing w organizacjach non-profit*. Warszawa: Difin.
- Majewski, P. (2007). *Czas na e-biznes*. Gliwice: Helion.
- Trocki, M. (2001). *Outsourcing: Metoda restrukturyzacji działalności gospodarczej*. Warszawa: PWE.
- Vollmuth, H. J. (1995). *Controlling: Instrumenty od A do Z*. Warszawa: Placet.
- Waters, D. (2001). *Zarządzanie operacyjne: Towary i usługi*. Warszawa: PWN.
- Wojciechowski, T. (2003). *Marketing na rynku środków produkcji*. Warszawa: PWE.
- Wrycza, S. (2010). *Informatyka ekonomiczna: Podręcznik akademicki*. Warszawa: PWE.

## Contact information

### Artur Zygiert

University of Social Sciences, Społeczna Akademia Nauk  
9 Sienkiewicza St., 90-113 Łódź, Poland  
E-mail: [mr.jaff@wp.pl](mailto:mr.jaff@wp.pl)  
ORCID: 0000-0001-5012-9599

doi: 10.7441/dokbat.2019.111

Name of publication: DOKBAT 2019 - 15th International Bata Conference for Ph.D. Students and Young Researchers

Edited by: Ing. Pavel Ondra

Publisher: Tomas Bata University in Zlín

Issue: Second edition

Published: Electronically

Year of publication: 2021

The conference proceedings have not undergone language correction.

ISBN: 978-80-7454-980-9

DOI: 10.7441/dokbat.2019

**Expert guarantor:**

Ing. Lubor Homolka, Ph.D.

**Manager and coordinator:**

Ing. Pavel Ondra

**Members of the organizing team:**

Ing. Michael Fafílek

Ing. Marek Koňářík

Ing. Lukáš Zlámal